



Riga Senior European Cup 2026

Latvia, Riga, 21-22 Mar 2026

-60 kg

Men (19)

POOL A

| | | |
|--|--------------------|-----|
| | ANDREINI Pietro | ITA |
| | KLEPININ Oleksandr | UKR |
| | WALINGA Ruben | NED |
| | JEKABSONS Jekabs | LAT |
| | BERSANETTI Yuri | ITA |

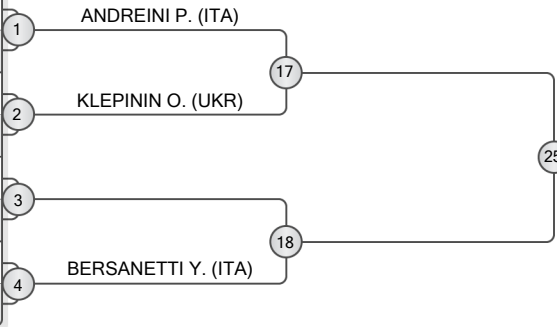

POOL B

| | | |
|--|-------------------|-----|
| | TUPYTSKYI Denys | UKR |
| | HILL Laurence | GBR |
| | DEL RE Alessandro | ITA |
| | WONG Jason | NED |
| | IACOMI Vladimir | MDA |

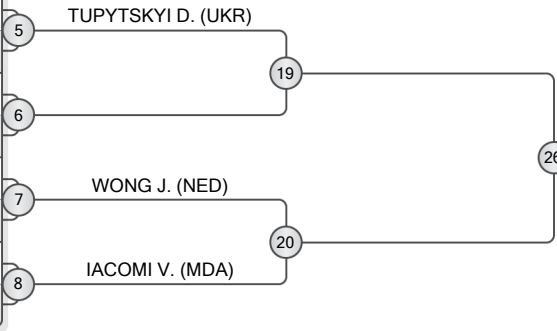

POOL C

| | | |
|--|-------------------|-----|
| | SHCHEKOTIN Filipp | EST |
| | ADRIF Nordine | GBR |
| | WONG Janson | NED |
| | ERRICHELLO Davide | ITA |

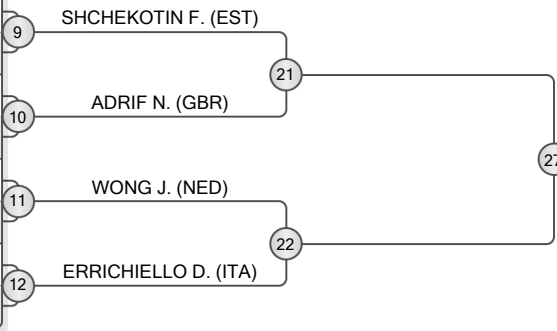

POOL D

| | | |
|--|-----------------------|-----|
| | KIM Serhii | UKR |
| | REA Diego | ITA |
| | LASSA IGLESIAS Javier | ESP |
| | CHIARELLA Luca | ITA |
| | HARTGRING Pepijn | NED |

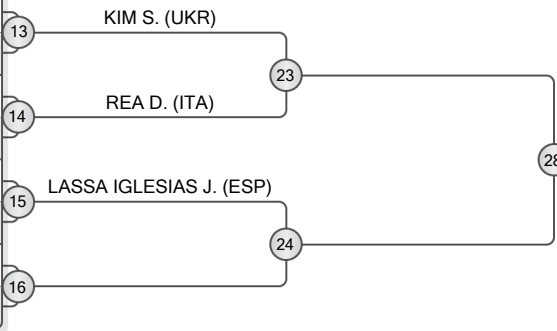

REPECHAGE

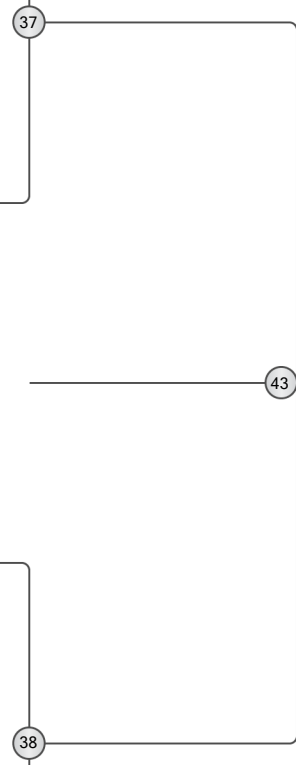

FINAL RESULTS





Riga Senior European Cup 2026

Latvia, Riga, 21-22 Mar 2026

-66 kg

Men (26)

POOL A

| | | |
|--|-------------------|-----|
| | IZVOREANU Radu | MDA |
| | CHRYSCINA Adam | POL |
| | MARANDIAN Karo | UKR |
| | HERRMANN Liam | GER |
| | VANKERKEM Mathieu | BEL |
| | GRAY James | GBR |
| | OJANNE Justus | FIN |

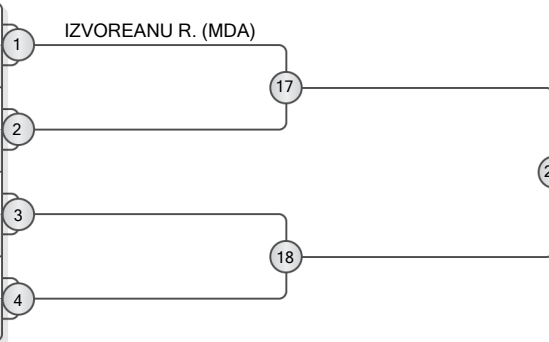

POOL B

| | | |
|--|-------------------------|-----|
| | DELLO RUSSO Lino Andrea | GER |
| | MAKULAVICIUS Rokas | LTU |
| | AZARUMYAN Artak | EST |
| | BROVOLD Gustav | NOR |
| | RASKIN Yan | UKR |
| | ANASTASOPOULOS Adam | GRE |

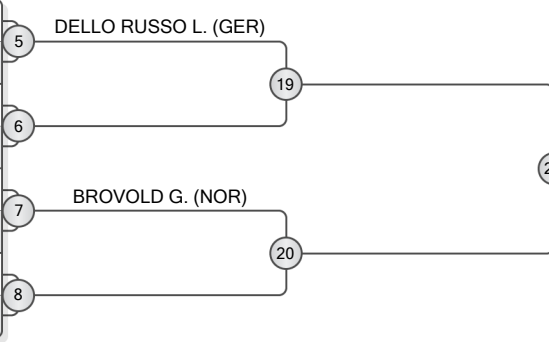

POOL C

| | | |
|--|-------------------|-----|
| | KLACAR Dani | CRO |
| | KURKOID Heorhii | UKR |
| | SETZ Martin | GER |
| | MACDONALD Neil | GBR |
| | NORKEVICIUS Matas | LTU |
| | HERMSEN Dani | NED |
| | FITYKA Mateusz | POL |

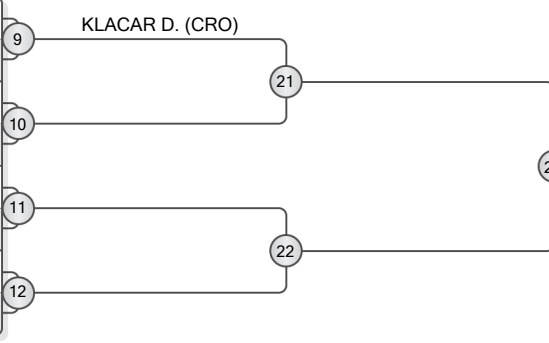

POOL D

| | | |
|--|------------------------|-----|
| | RIPSATER Isac | SWE |
| | KONT Carl-Gustav | EST |
| | MORELLI Nicolo' | ITA |
| | BOECKER Florian | GER |
| | LUKASHEVSKYI Volodymyr | LTU |
| | KUJANHAARA Joonatan | FIN |

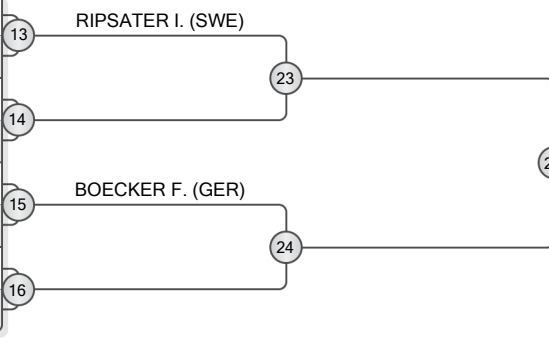

REPECHAGE



FINAL RESULTS





Riga Senior European Cup 2026

Latvia, Riga, 21-22 Mar 2026

-73 kg

Men (40)

POOL A

| | | | | |
|----|-------------------|-----|----|--------------------|
| 1 | MITRU Vlad | MDA | 1 | MITRU V. (MDA) |
| 2 | TRILLJARV Matheas | EST | 33 | |
| 3 | MAXLIN Miljohn | SWE | 49 | |
| 4 | VEIJOLA Iikka | FIN | 3 | VEIJOLA I. (FIN) |
| 5 | ALLAN Finlay | GBR | 4 | ALLAN F. (GBR) |
| 6 | ROMA Riccardo | ITA | 34 | |
| 7 | VOITOV Vadym | UKR | 50 | |
| 8 | MICHNA Kamil | POL | 6 | MICHNA K. (POL) |
| 9 | SUHORUKOV Daniils | LAT | 7 | SUHORUKOV D. (LAT) |
| 10 | GUENTHER Nouri | GER | 8 | GUENTHER N. (GER) |

POOL B

| | | | | |
|----|-------------------------|-----|----|------------------------|
| 9 | LENAERTS Nathan | BEL | 9 | LENAERTS N. (BEL) |
| 10 | JACKSON Thomas | GBR | 37 | JACKSON T. (GBR) |
| 11 | BOSIS Federico | ITA | 51 | |
| 12 | RAULUSONIS Augis | LTU | 38 | SOTILLO GOMEZ C. (ESP) |
| 13 | HENRIKSSON Emil | SWE | 13 | HENRIKSSON E. (SWE) |
| 14 | KORHONEN Roope | FIN | 39 | |
| 15 | BIRKHANS Toms Kristians | LAT | 52 | SCHMIDT N. (GER) |
| 16 | SCHMIDT Noel | GER | 15 | SCHMIDT N. (GER) |
| 17 | MOST Lennart | NED | 16 | MOST L. (NED) |

POOL C

| | | | | |
|----|------------------------|-----|----|--------------------|
| 17 | KULIESHOV Nazar | UKR | 17 | KULIESHOV N. (UKR) |
| 18 | BULAJEVs Maksims | LAT | 41 | |
| 19 | ALEKSEJUNAS Natas | LTU | 53 | BERGFELD D. (NED) |
| 20 | BERGFELD David | NED | 19 | BERGFELD D. (NED) |
| 21 | CROITORU Renat | MDA | 20 | CROITORU R. (MDA) |
| 22 | ZVANERS Daniels | LAT | 42 | |
| 23 | MCCANN Kieran | GBR | 54 | GOGUA T. (GRE) |
| 24 | GOGUA Theodoros | GRE | 22 | GOGUA T. (GRE) |
| 25 | MARASTONI Matthew Paul | ITA | 23 | MARASTONI M. (ITA) |
| 26 | WIENEKE Vincent | GER | 24 | WIENEKE V. (GER) |

POOL D

| | | | | |
|----|-------------------------|-----|----|-----------------------|
| 25 | MERMELSSTEIN Almog | ISR | 25 | MERMELSSTEIN A. (ISR) |
| 26 | KALNINS Patriks | LAT | 45 | |
| 27 | VESTE Andrian | MDA | 55 | ADARVEZ K. (ARG) |
| 28 | ADARVEZ Karim | ARG | 27 | ADARVEZ K. (ARG) |
| 29 | PERTELSON Oscar | EST | 28 | PERTELSON O. (EST) |
| 30 | PERTELSON Oscar | EST | 46 | |
| 31 | TAAVITSAINEN Jesper | FIN | 29 | TAAVITSAINEN J. (FIN) |
| 32 | IOVINE Lorenzo | ITA | 47 | KARALEVICIUS Z. (LTU) |
| 33 | KARALEVICIUS Zygimantas | LTU | 30 | KARALEVICIUS Z. (LTU) |
| 34 | VARDANIAN Narek | SWE | 31 | VARDANIAN N. (SWE) |
| 35 | MOORE Ben | GBR | 32 | MOORE B. (GBR) |

REPECHAGE

| | | | | |
|----|--|--|----|--|
| 61 | | | 65 | |
| 62 | | | 66 | |
| 63 | | | 67 | |
| 64 | | | 68 | |

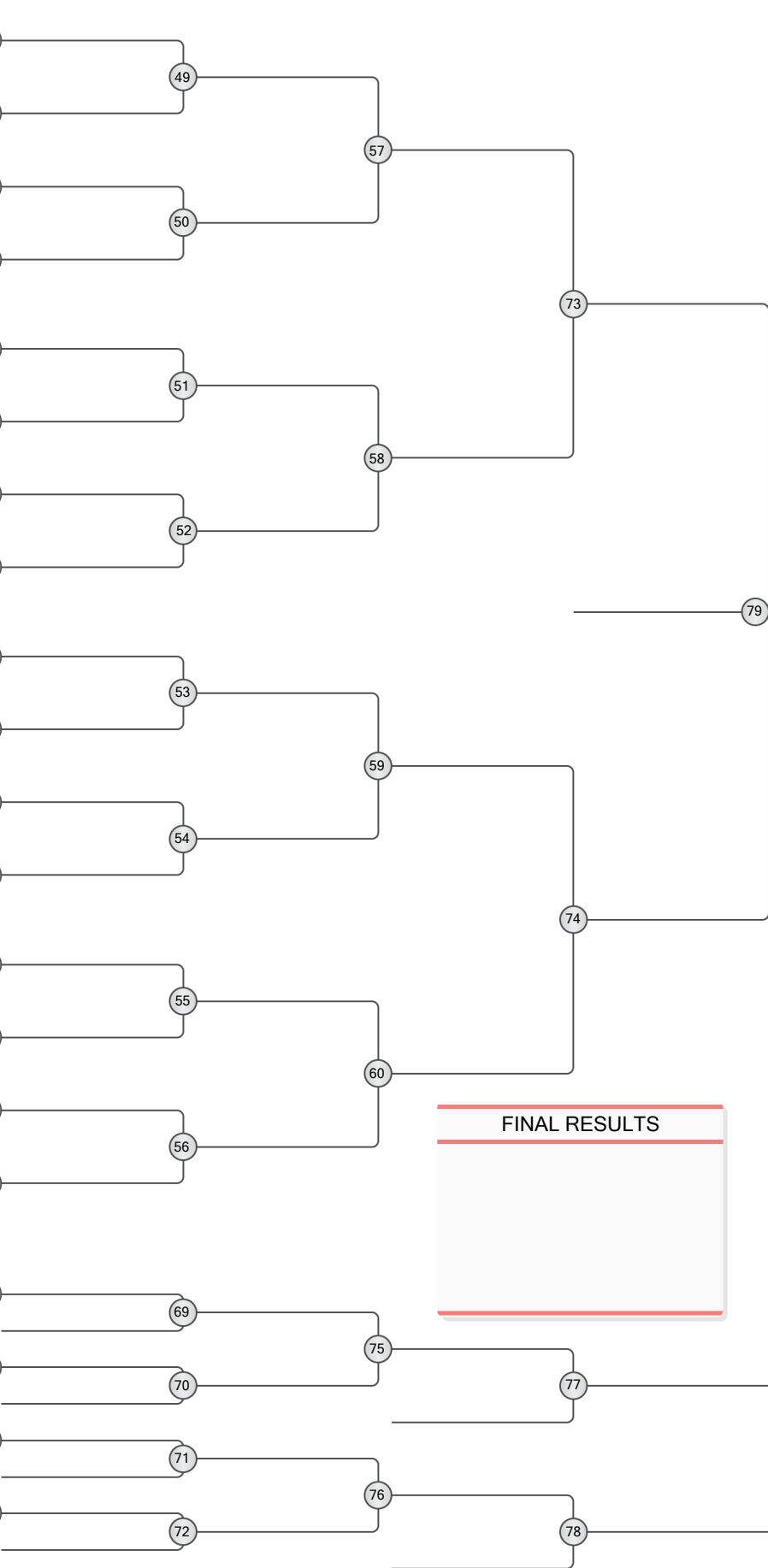

FINAL RESULTS





Riga Senior European Cup 2026

Latvia, Riga, 21-22 Mar 2026

-81 kg

Men (35)

POOL A

| | | |
|--|---------------------|-----|
| | GANDIA Adrian | PUR |
| | ZALEVSKIS Fjodors | LAT |
| | VAN VELTHUIJSEN Jip | NED |
| | NOACK Gerrit | GER |
| | JOLKIN Nikita | EST |
| | RIBAKOVVS Levs | LAT |
| | CHIARI Nicola | ITA |
| | MATTSSON Ville | SWE |
| | JAPINS Raivis | LAT |

| | |
|---|--------------------------|
| 1 | GANDIA A. (PUR) |
| 2 | ZALEVSKIS F. (LAT) |
| 3 | VAN VELTHUIJSEN J. (NED) |
| 4 | NOACK G. (GER) |
| 5 | JOLKIN N. (EST) |
| 6 | RIBAKOVVS L. (LAT) |
| 7 | CHIARI N. (ITA) |
| 8 | JAPINS R. (LAT) |

POOL B

| | | |
|--|----------------------|-----|
| | HERMODSSON Olof | SWE |
| | PAVARS Markuss | LAT |
| | KLYMENKO Anton | UKR |
| | BERG Bert | EST |
| | TYRRELL Rory | GBR |
| | CELADINS Nikita | LAT |
| | ARGOV Or | ISR |
| | GREEN Callum | IRL |
| | VAN DER VEEN Quinten | NED |

| | |
|----|-----------------------|
| 9 | HERMODSSON O. (SWE) |
| 10 | PAVARS M. (LAT) |
| 11 | KLYMENKO A. (UKR) |
| 12 | BERG B. (EST) |
| 13 | TYRRELL R. (GBR) |
| 14 | CELADINS N. (LAT) |
| 15 | ARGOV O. (ISR) |
| 16 | VAN DER VEEN Q. (NED) |

POOL C

| | | |
|--|-----------------------|-----|
| | BREKKE-JENSSEN Martin | NOR |
| | RISTMAE Joonatan | EST |
| | BURGERS Luca | NED |
| | PURPISS Nikass | LAT |
| | GRENDYS Mateusz | POL |
| | GOEBEL Matti | GER |
| | VISNOVS Pavels | LAT |
| | FOX KENNEDY Benjamin | GBR |

| | |
|----|-------------------------|
| 17 | BREKKE-JENSSEN M. (NOR) |
| 18 | RISTMAE J. (EST) |
| 19 | BURGERS L. (NED) |
| 20 | PURPISS N. (LAT) |
| 21 | GRENDYS M. (POL) |
| 22 | GOEBEL M. (GER) |
| 23 | VISNOVS P. (LAT) |
| 24 | FOX KENNEDY B. (GBR) |

POOL D

| | | |
|--|--------------------|-----|
| | PLOSTNIEKS Ronalds | LAT |
| | VAN SINDEREN Mika | NED |
| | MARLOV Alexander | SWE |
| | ASKHAM Djoni | DEN |
| | GUDEJEVS Arsenijs | LAT |
| | GRIBINET Ciprian | MDA |
| | MALONKIN Bohdan | UKR |
| | JAVORSKIS Roberts | LAT |
| | MAKINEN Oskari | FIN |

| | |
|----|-----------------------|
| 25 | PLOSTNIEKS R. (LAT) |
| 26 | VAN SINDEREN M. (NED) |
| 27 | MARLOV A. (SWE) |
| 28 | ASKHAM D. (DEN) |
| 29 | GUDEJEVS A. (LAT) |
| 30 | GRIBINET C. (MDA) |
| 31 | MALONKIN B. (UKR) |
| 32 | JAVORSKIS R. (LAT) |
| 33 | MAKINEN O. (FIN) |

REPECHAGE

| | |
|----|--|
| 61 | |
| 62 | |
| 63 | |
| 64 | |

| | |
|----|--|
| 65 | |
| 66 | |
| 67 | |
| 68 | |

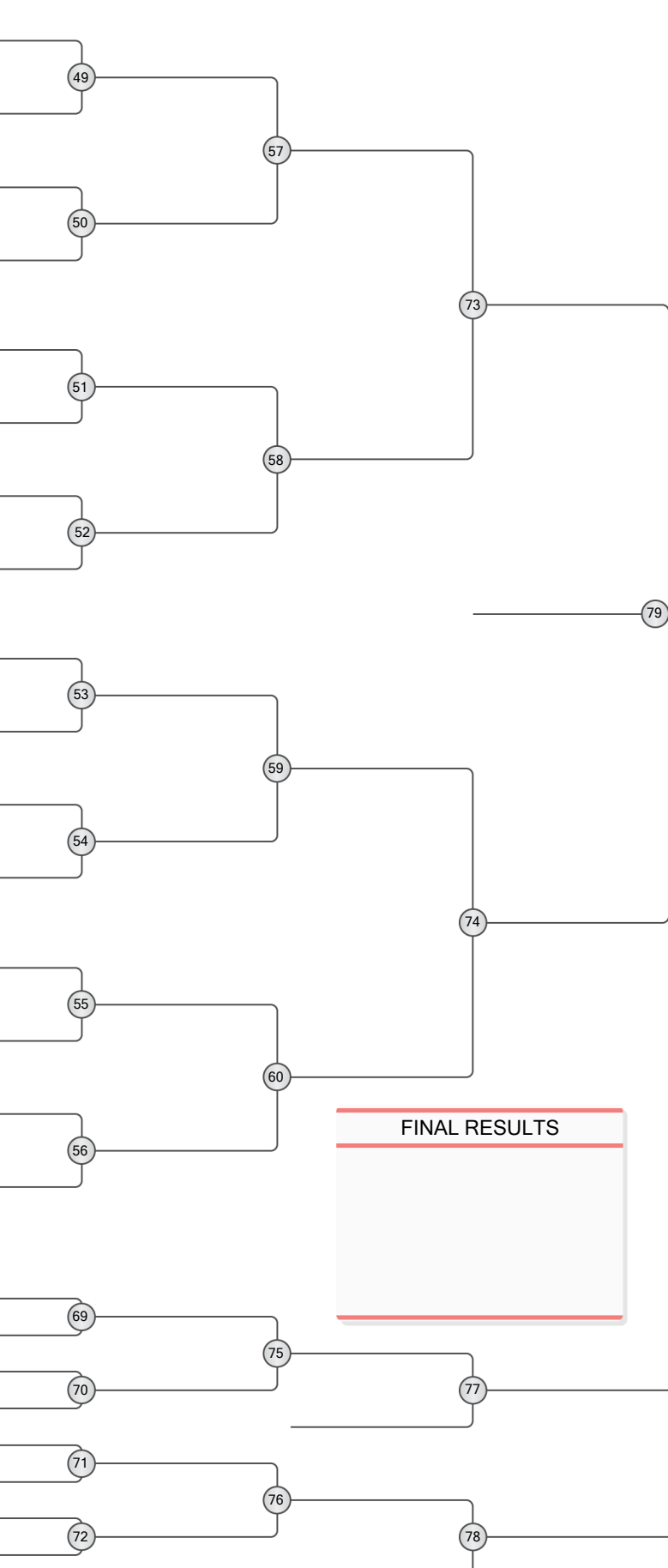

FINAL RESULTS





Riga Senior European Cup 2026

Latvia, Riga, 21-22 Mar 2026

-90 kg

Men (24)

POOL A

| | | |
|--|-------------------|-----|
| | LATISEV Mihail | MDA |
| | BOGDANOVŠ Stepans | LAT |
| | BABAICENKO Tajus | LTU |
| | JACENKO Arturs | LAT |
| | ARTICOLO Danilo | ITA |
| | DACOSTA Ryan | SEN |

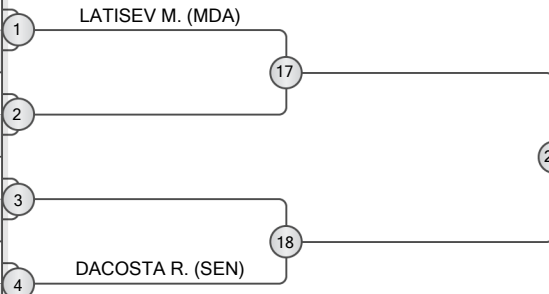

POOL B

| | | |
|--|----------------------|-----|
| | CUSACK Scott | GBR |
| | MAERKT Elija Ruben | GER |
| | SERHIICHUK Stanislav | UKR |
| | MANFELDS Tomass | LAT |
| | DRUZETA Dominik | CRO |
| | JANSEN Dylan | NED |

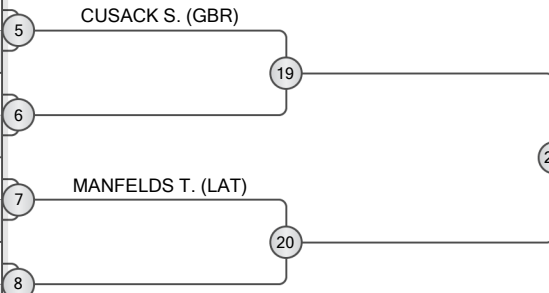

POOL C

| | | |
|--|----------------------|-----|
| | JAYNE John | USA |
| | HEDENBLAD Joel | SWE |
| | PETGRAVE Samuel | GBR |
| | TOKHTAMYSH Oleksandr | UKR |
| | MIKUCKIS Francis | LAT |
| | SCHREDER Leon | GER |

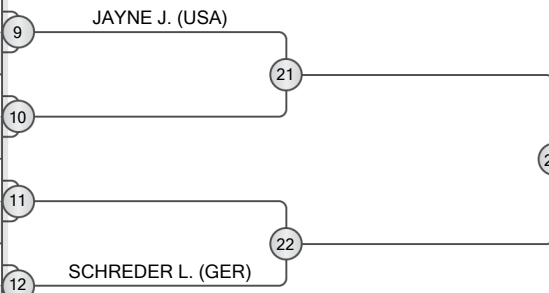

POOL D

| | | |
|--|------------------------|-----|
| | DAVLADZE Nikoloz | GEO |
| | PIPPA Luigi | ITA |
| | SABASTIJANSKAS Dovydas | LTU |
| | REID-THOMAS Cameron | GBR |
| | PLOSTNIEKS Eduards | LAT |
| | MAOR Gal | ISR |

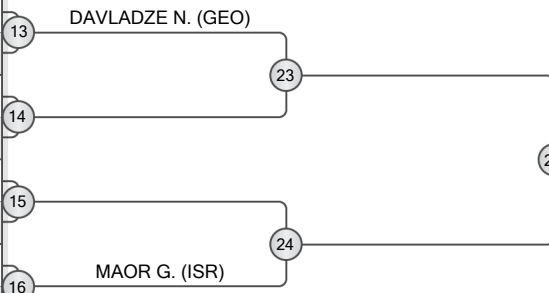

REPECHAGE

| | | |
|----|--|--|
| 29 | | |
| 30 | | |
| 31 | | |
| 32 | | |

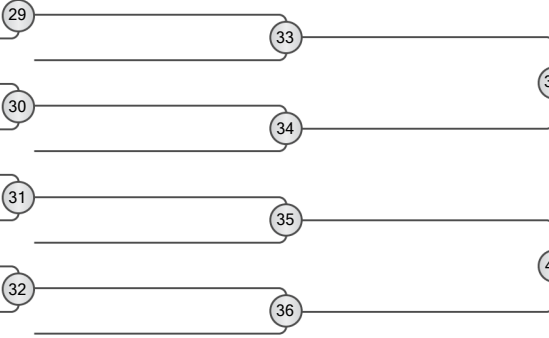

FINAL RESULTS





Riga Senior European Cup 2026

Latvia, Riga, 21-22 Mar 2026

-100 kg

Men (18)

POOL A

| | | |
|--|-------------------|-----|
| | GROMOV S Daniils | LAT |
| | LANGESAETER Jonas | NOR |
| | VISSERS Lars | NED |
| | WESTERMARCK Pyry | FIN |
| | ERDMANN Leo | GER |

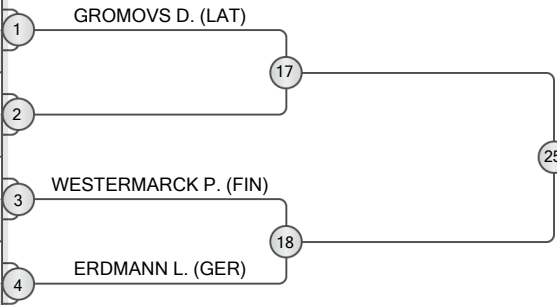

POOL B

| | | |
|--|------------------|-----|
| | MATTSSON Nils | SWE |
| | KUESTER Ilias | GER |
| | DOL Giel | NED |
| | BARGIONI Niccolo | GBR |

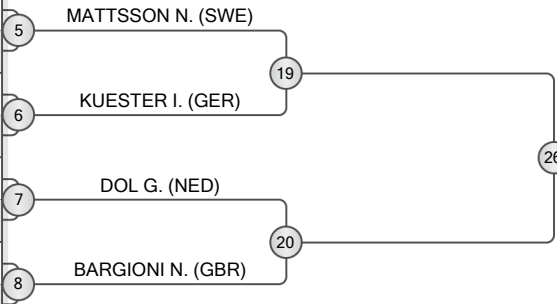

POOL C

| | | |
|--|--------------------|-----|
| | HEEREN Axel | NED |
| | KHAN Hamza Ahmad | NOR |
| | ZALAIKALNS Andrejs | LAT |
| | VARES Jakob | EST |
| | CALDER Jaden | GBR |

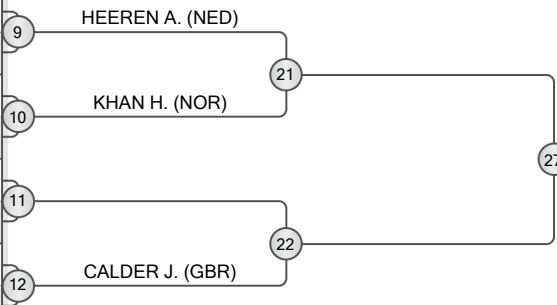

POOL D

| | | |
|--|----------------|-----|
| | KUBIAK Damian | POL |
| | VALIEIEV Tymur | UKR |
| | NESTOR Kevin | SWE |
| | BASCHIN Jannis | GER |

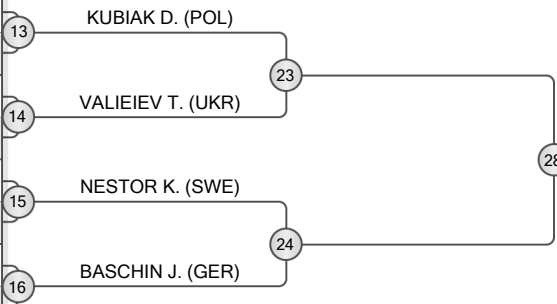

REPECHAGE

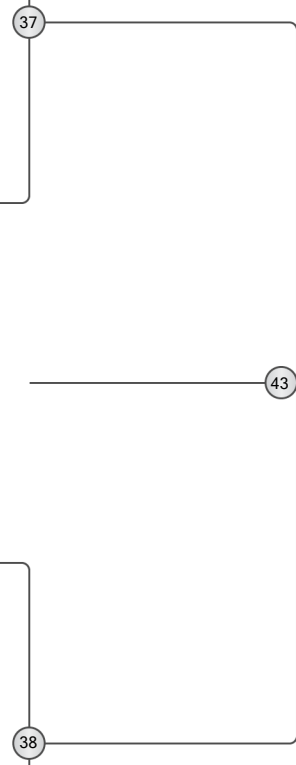

FINAL RESULTS





Riga Senior European Cup 2026

Latvia, Riga, 21-22 Mar 2026

+100 kg

Men (10)

POOL A

| | | |
|--|------------------|-----|
| | PEKOVIC Jovan | MNE |
| | HALL Adam | GBR |
| | YAROSHENKO Fedir | UKR |

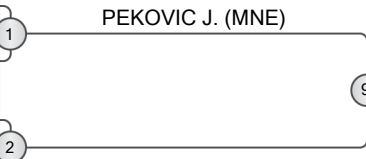

POOL B

| | | |
|--|----------------|-----|
| | MILLER Gregor | GBR |
| | MASTEIKA Titas | LTU |



POOL C

| | | |
|--|----------------|-----|
| | MAIBORODA Ivan | UKR |
| | PRICE William | GBR |

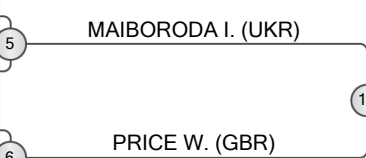

POOL D

| | | |
|--|--------------------|-----|
| | WELLER-HENRY James | GBR |
| | ZAVIISKYI Yurii | UKR |
| | KIRNA Kabriel | EST |



REPECHAGE

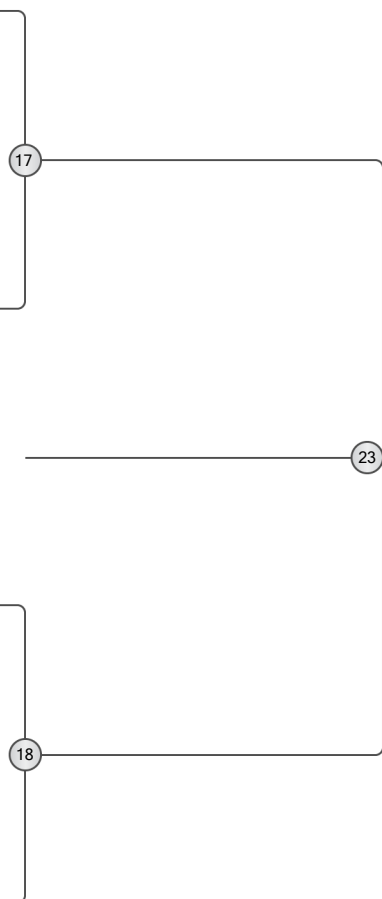
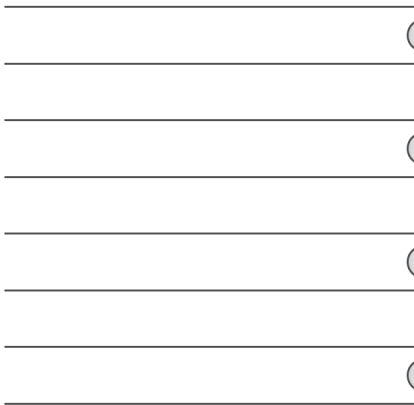

| FINAL RESULTS | |
|---------------|--|
| | |
| | |





Riga Senior European Cup 2026

Latvia, Riga, 21-22 Mar 2026

-52 kg

Women (9)

POOL A

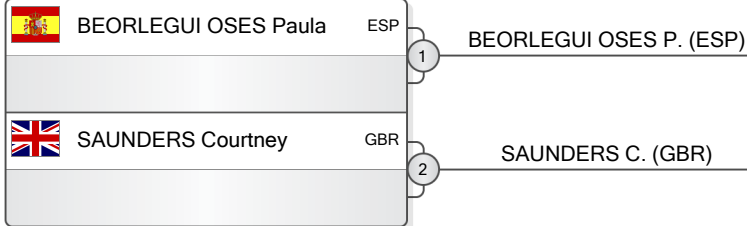

POOL B

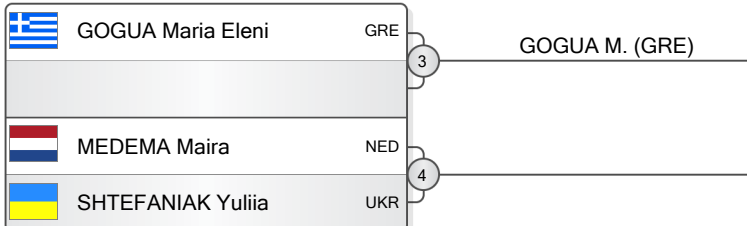

POOL C

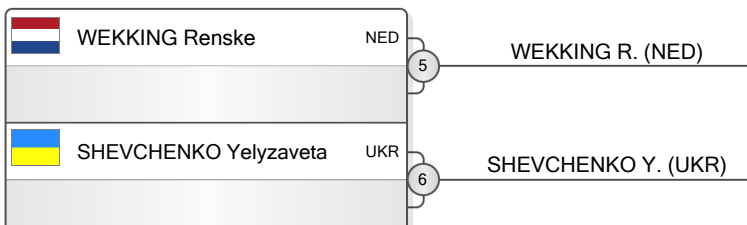

POOL D

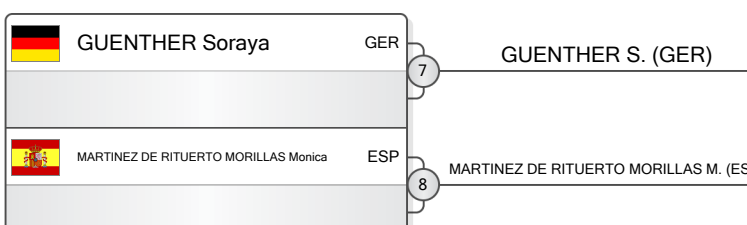

REPECHAGE

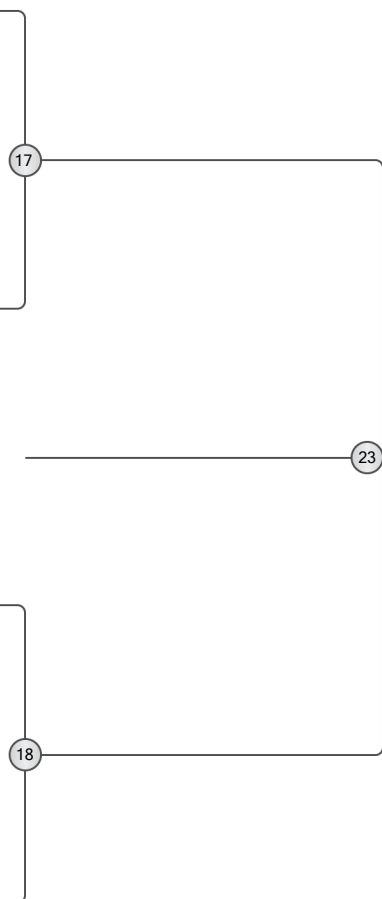
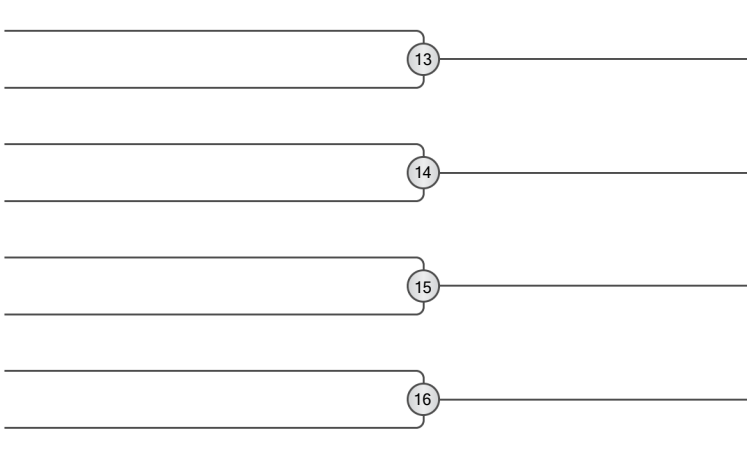

FINAL RESULTS





Riga Senior European Cup 2026

Latvia, Riga, 21-22 Mar 2026

-57 kg

Women (17)

POOL A

| | | | | |
|--|------------------------|-----|---|---------------------------|
| | BORTAS Dora | CRO | 1 | BORTAS D. (CRO) |
| | CAGGIANO Giulia | ITA | 2 | CAGGIANO G. (ITA) |
| | BULDAIN ELIZALDE Joana | ESP | 3 | BULDAIN ELIZALDE J. (ESP) |
| | SCHARNBERG Sophie | GER | 4 | SCHARNBERG S. (GER) |

POOL B

| | | | | |
|--|------------------------|-----|---|----------------------|
| | SOKIRJANSKA Anastasija | LAT | 5 | SOKIRJANSKA A. (LAT) |
| | CHYZHEVSKA Anastasiia | UKR | 6 | CHYZHEVSKA A. (UKR) |
| | BULANDA Julia | POL | 7 | BULANDA J. (POL) |
| | NURM Anna Liisa | EST | 8 | NURM A. (EST) |

POOL C

| | | | | |
|--|----------------------|-----|----|-----------------------|
| | TARKUS Merit | EST | 9 | TARKUS M. (EST) |
| | GRAJAUSKAITE Samanta | LTU | 10 | GRAJAUSKAITE S. (LTU) |
| | ZIEGLER Jana | GER | 11 | ZIEGLER J. (GER) |
| | SHYNKARENKO Inna | UKR | 12 | SHYNKARENKO I. (UKR) |

POOL D

| | | | | |
|--|--------------------|-----|----|-------------------|
| | HILLER Lisa | GER | 13 | HILLER L. (GER) |
| | SHYLOVA Alina | UKR | 14 | SHYLOVA A. (UKR) |
| | VAN KERKHOF Mirthe | NED | 15 | |
| | MIHHAILOVA Darja | EST | 15 | |
| | STOPPARI Emma | ITA | 16 | STOPPARI E. (ITA) |

REPECHAGE

| | |
|----|----|
| 29 | 33 |
| 30 | 34 |
| 31 | 35 |
| 32 | 36 |

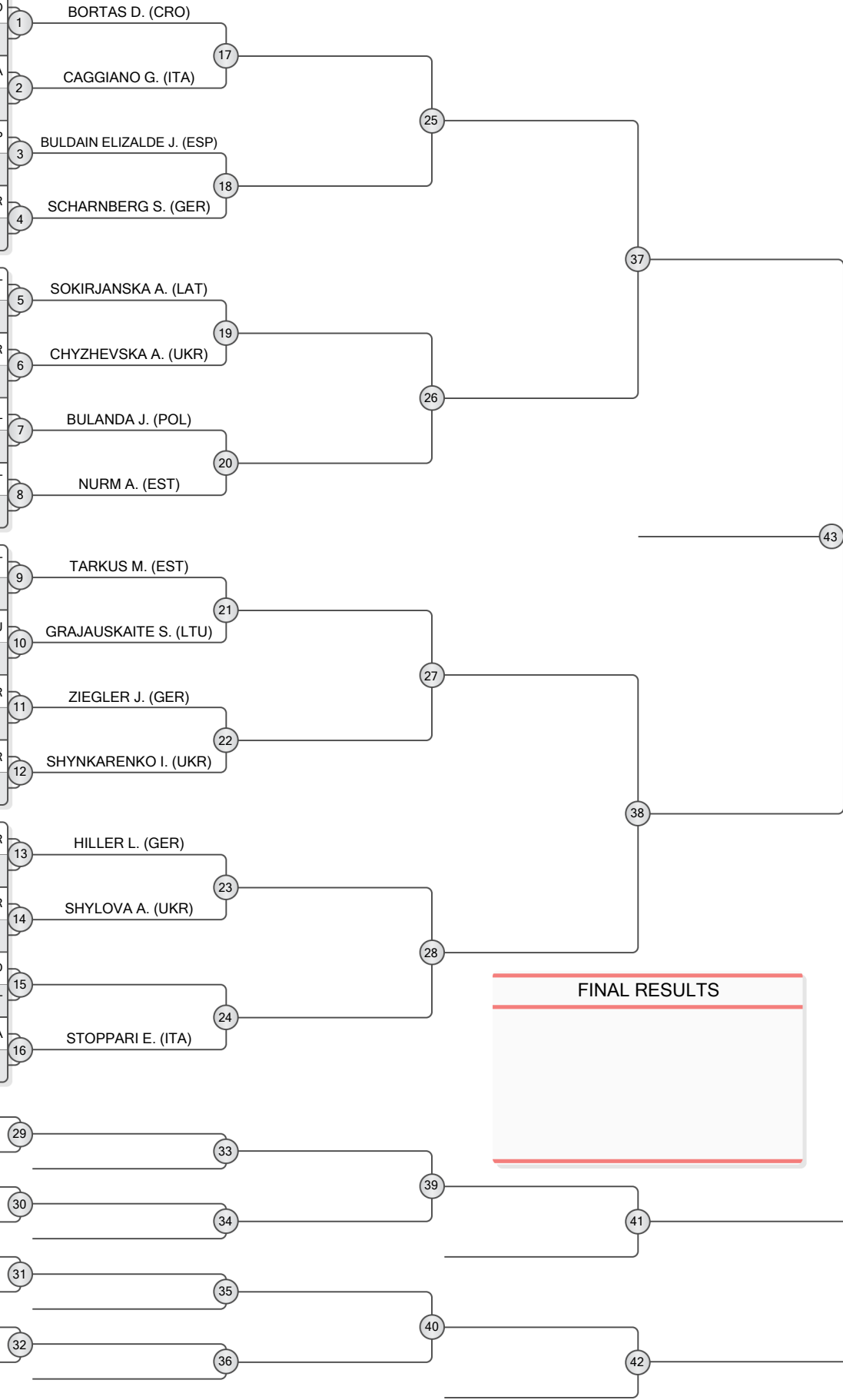

FINAL RESULTS





Riga Senior European Cup 2026

Latvia, Riga, 21-22 Mar 2026

-63 kg

Women (14)

POOL A

| | | | |
|--|--------------|-----|---|
| | CVJETKO Nina | CRO | 1 |
| | WOOD Sophie | GBR | 2 |
| | KUCHAVA Iia | UKR | |

CVJETKO N. (CRO)

POOL B

| | | | |
|--|------------------|-----|---|
| | BADURA Daniela | POL | 3 |
| | JAWOROWSKI Naemi | SWE | |
| | LOWRY Robin | IRL | 4 |
| | PROCTOR Roxanne | GBR | |

POOL C

| | | | |
|--|------------------------|-----|---|
| | VON LEUPOLDT Charlotte | GER | 5 |
| | DOIG Sunny | GBR | 6 |
| | BACKLUND Vilda | SWE | |

VON LEUPOLDT C. (GER)

POOL D

| | | | |
|--|--------------------|-----|---|
| | IMRIE Tomi | GBR | 7 |
| | KRAVCHUK Valeriia | UKR | |
| | CHRISTENSEN Helene | DEN | 8 |
| | OSTLIND Gretha | SWE | |

REPECHAGE

| | | | |
|--|--|--|----|
| | | | 13 |
| | | | 14 |
| | | | 15 |
| | | | 16 |

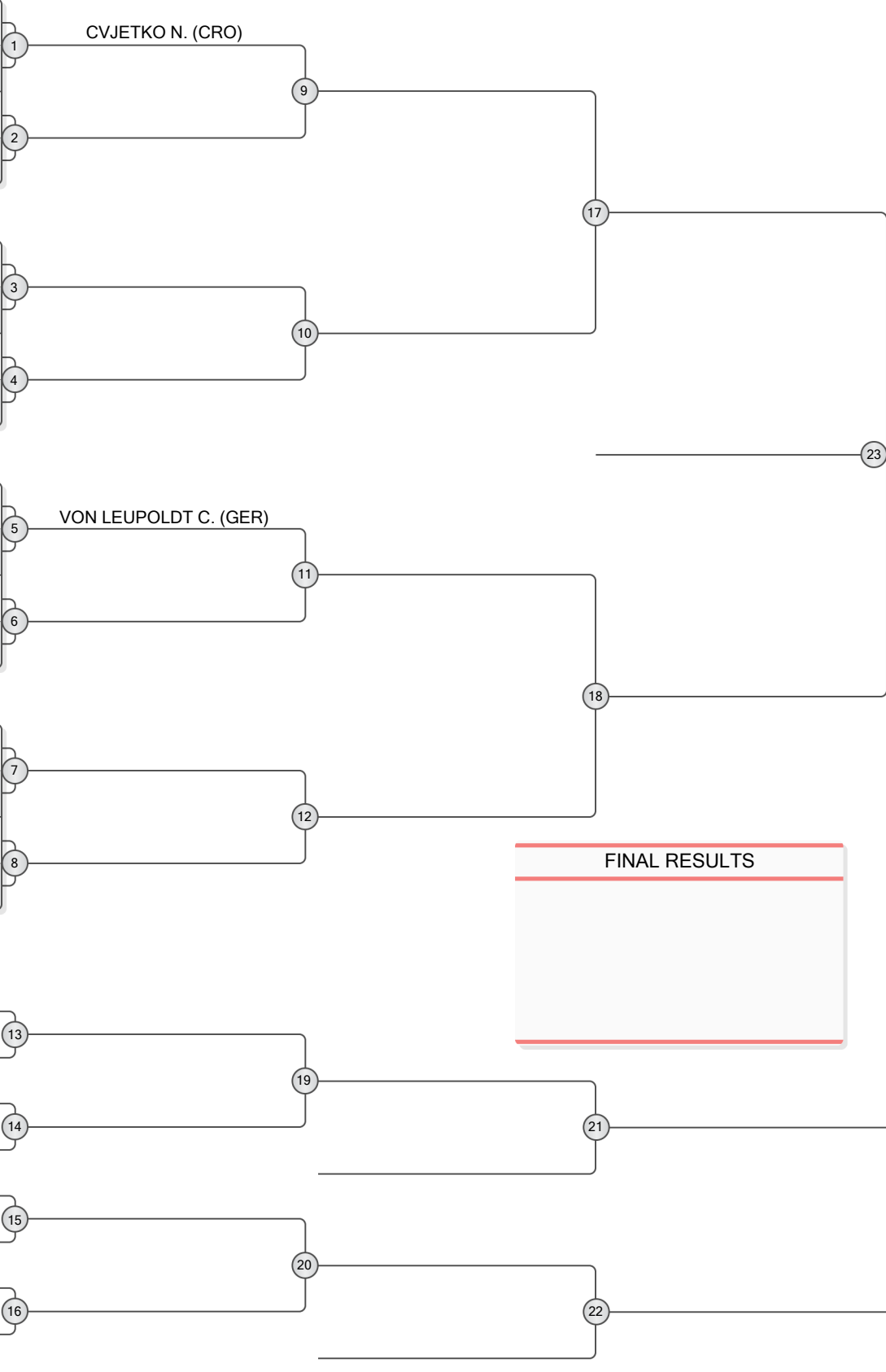

FINAL RESULTS





Riga Senior European Cup 2026

Latvia, Riga, 21-22 Mar 2026

-70 kg

Women (13)

POOL A

| | | |
|--|-----------------------|-----|
| | BUDDENKOTTE Eva Ronja | GER |
| | RAGAUSKAITE Viktorija | LTU |
| | PONOMARJOVA Sofija | LAT |

BUDDENKOTTE E. (GER)

POOL B

| | | |
|--|---------------------|-----|
| | MADDALONI Serena | ITA |
| | RABI Anika | GBR |
| | NIEMINEN Enna | FIN |
| | VAN WONDEREN Dagmar | NED |

RABI A. (GBR)

POOL C

| | | |
|--|---------------------|-----|
| | RIBEIRO NOVAIS Maya | SWE |
| | TOMBOU Valerie | BEL |
| | NOACK Nele | GER |

RIBEIRO NOVAIS M. (SWE)

POOL D

| | | |
|--|-------------------|-----|
| | HANSEN Karoline | DEN |
| | CVJETKO Jana | CRO |
| | FRANZOSI Ludovica | ITA |

HANSEN K. (DEN)

REPECHAGE

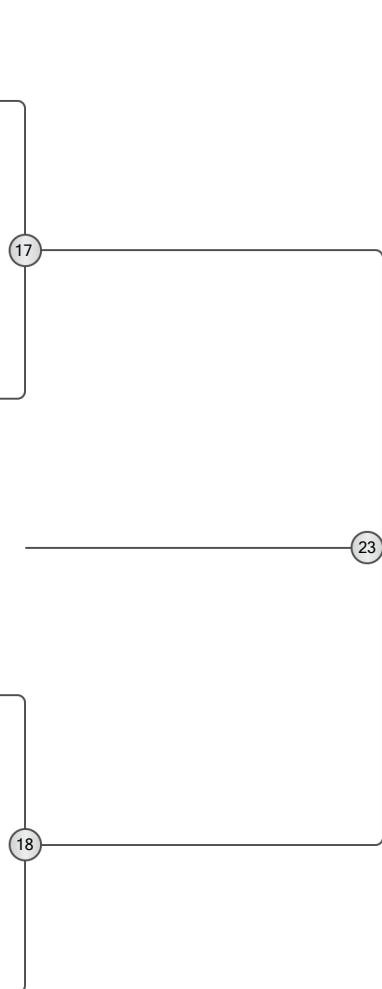
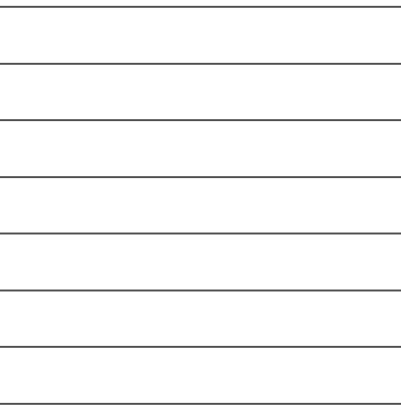

| FINAL RESULTS | |
|---------------|--|
| | |
| | |





Riga Senior European Cup 2026

Latvia, Riga, 21-22 Mar 2026

-78 kg

Women (7)

POOL A

| | | |
|--|------------|-----|
| | JAKUS Nika | CRO |
| | | |

JAKUS N. (CRO)

POOL B

| | | |
|--|----------------------|-----|
| | NORGELAITE Viktorija | LAT |
| | WOOD Nicole | GBR |

POOL C

| | | |
|--|-------------|-----|
| | HASSAN Anya | GBR |
| | JELCIC Ani | CRO |

POOL D

| | | |
|--|----------------------|-----|
| | SOTILLO GOMEZ Begona | ESP |
| | HAWKES Rachael | GBR |

REPECHAGE

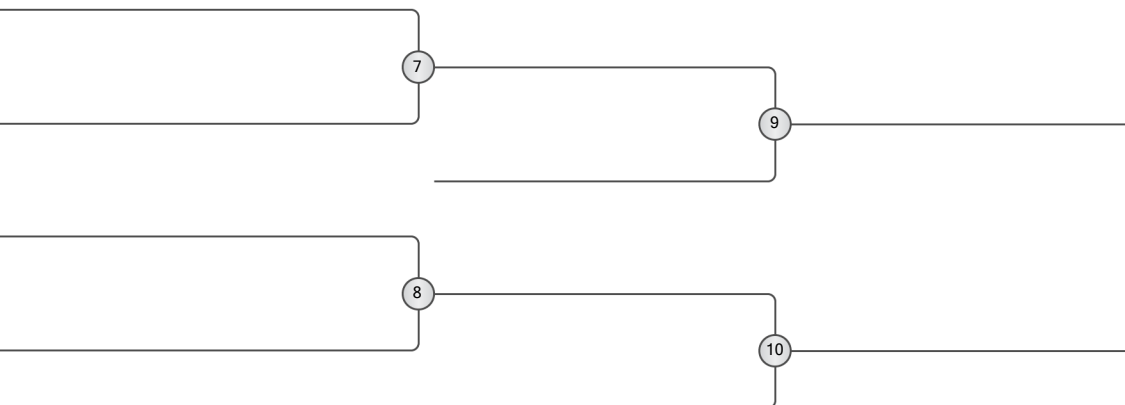

FINAL RESULTS

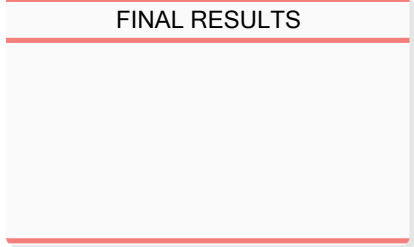



Riga Senior European Cup 2026

Latvia, Riga, 21-22 Mar 2026

+78 kg

Women (3)

| Num. | Competitor | | 1 | 2 | 3 | Wins | Points |
|------|-------------------|-----|---|---|---|------|--------|
| 1. | BOUVIER Gabrielle | BEL | | | | 0 | 0 |
| 2. | MARANIC Ivana | CRO | | | | 0 | 0 |
| 3. | SEMCHENKO Diana | UKR | | | | 0 | 0 |

| | | |
|-------------------|-----|---|
| BOUVIER Gabrielle | BEL | 1 |
| MARANIC Ivana | CRO | |

| | |
|---------------|--|
| FINAL RESULTS | |
| | |

| | | |
|-------------------|-----|---|
| BOUVIER Gabrielle | BEL | 2 |
| SEMCHENKO Diana | UKR | |

| | | |
|-----------------|-----|---|
| MARANIC Ivana | CRO | 3 |
| SEMCHENKO Diana | UKR | |

| | | |
|--|--|---|
| | | 4 |
| | | |