



## 252 competitors from 33 nations

173 Men

79 Women

68.65%

31.35%

-60 kg	-66 kg	-73 kg	-81 kg	-90 kg	-100 kg	+100 kg	Men
17	34	44	33	23	13	9	173

-48 kg	-52 kg	-57 kg	-63 kg	-70 kg	-78 kg	+78 kg	Women
16	11	18	7	14	9	4	79

Continent	AJU	JUA	EJU	OJU	PJC	OTH	Total
Nations		5	25		2	1	33
Competitors		19	229		3	1	252

Schedule	Day 1	Day 2
Date	6 Jun	7 Jun
Start	10:00	10:00
End	14:30	14:00
Finals start	15:00	14:45
Finals end	17:35	19:00



# Tallinn European Open 2026

Estonia, Tallin, 6-7 Jun 2026

Men  
**Final results**

-60 kg		
1	AGHASYAN Vahe	ARM
2	IGNASIAK Ksawery	POL
3	ANDREINI Pietro	ITA
3	TUPYTSKYI Denys	UKR
5	BIEDRZYCKI Hubert	POL
5	SODANO Raffaele	ITA
7	SHULMAN Ariel	ISR
7	BADALYAN Martin	ARM

-66 kg		
1	KOKOLAYEV Matan	ISR
2	MARTIROSIAN Hahik	UKR
3	NINFO Federico	ITA
3	VISKOV Nazar	UKR
5	DUBINA Hlib	UKR
5	DE LUCA Alessio	ITA
7	CYSIQUE William	FRA
7	JAKIMOV Edward	EST

-73 kg		
1	ALOEV Mukhamed	BRN
2	BOSIS Federico	ITA
3	GREEN Joshua	IRL
3	MARINX Ray	BEL
5	CROITORU Renat	MDA
5	VIERU Denis	MDA
7	GINER Oron	ISR
7	VESTE Andrian	MDA

-81 kg		
1	GASANOV Gadzhidavud	BRN
2	GRIBINET Ciprian	MDA
3	OTMANE Luca	FRA
3	HERKOVIC Nace	SLO
5	DIKAJEV Saad	EST
5	ZHUMANAZAROV Ratbek	KGZ
7	NEYOLOV Artem	CAN
7	GIGLI Sacha	FRA

-90 kg		
1	BUBYR Artem	UKR
2	KUTENKOV Ivan	UKR
3	KANEVETS Artur	FIN
3	BEN HAROCH Segev	ISR
5	MYLONELIS Athanasios	GRE
5	KOMIN Kirill	EST
7	YLIRUUSI Teo	FIN
7	CHYZHEVSKYI Ghenadi	MDA

-100 kg		
1	DUINOVS Maksims	LAT
2	DUNIAMALIEV Zaur	UKR
3	KARAPETYAN Gor	ARM
3	CARLETTI Jean	ITA
5	BUTIJER Borna	CRO
5	PERNA Kevyn	ITA
7	NILLER Jaan	EST
7	WALENCIAK Marcin	POL

+100 kg		
1	MASAK Marek-Adrian	EST
2	KOVINIC Stefan	MNE
3	YAROSHENKO Fedir	UKR
3	PAPANIKOLAOU Panagiotis	GRE
5	SERIKOV Ardak	KAZ
5	KIRNA Kabriel	EST



# Tallinn European Open 2026

Estonia, Tallin, 6-7 Jun 2026

## Women Final results

-48 kg		
1	ANNIS Morgane	FRA
2	GUARDUCCI Elena	ITA
3	SIBILLE Victoria	BEL
3	SHAW Summer	GBR
5	SLAZOK Wiktorja	POL
5	LEPP Zeynab	IJF
7	IOVINO Anna	ITA
7	TCKAEVA Diana	AZE

-52 kg		
1	ROCCO Alessandra	ITA
2	KLIMCZAK Kinga	POL
3	MAMMADALIYEVA Gultaj	AZE
3	GALEK Martyna	POL
5	BARBER Caitlin	GBR
5	BORODINA Anna	UKR
7	SHEVCHENKO Yelyzaveta	UKR

-57 kg		
1	SOKIRJANSKA Anastasija	LAT
2	SIENNICKA Karolina	POL
3	KOWALCZYK Julia	POL
3	BULANDA Julia	POL
5	CHYZHEVSKA Anastasiia	UKR
5	MELIS Emma	FRA
7	COTARD Maelenn	FRA
7	ZAGURI Daniella	ISR

-63 kg		
1	BACKLUND Vilda	SWE
2	ALIZADA Fidan	AZE
3	CHRISTENSEN Helene	DEN
3	BADURA Daniela	POL
5	WATOREK Oliwia	POL
5	KUCHAVA lia	UKR

-70 kg		
1	SIMEOLI Nadia	ITA
2	CVJETKO Jana	CRO
3	RYTSKA Mariia	UKR
3	CHABAL Mathilde	FRA
5	FRANZOSI Ludovica	ITA
5	AMIHAI Shaked	ISR
7	MADDALONI Serena	ITA

-78 kg		
1	CHAYEB Aqulina	LBN
2	VUK Betty	CRO
3	POSVITE Fanny Estelle	FRA
3	KULIC Karla	CRO
5	KAZAKOVA Anna	UKR
5	AMIRLI Narmin	AZE

+78 kg		
1	AKTAS Emma-Melis	EST
2	DIACENCO Oxana	MDA
3	KAISINOVA Madina	AZE



# Medals

Tallinn European Open 2026, 6-7 Jun 2026

# Medals

Nations: 22

#	Nation		1. Place	2. Place	3. Place	5. Place	7. Place
1.		ITA Italy	2	2	3	4	2
2.		EST Estonia	2			3	2
3.		BRN Bahrain	2				
3.		LAT Latvia	2				
5.		UKR Ukraine	1	3	4	5	1
6.		FRA France	1		3	1	3
7.		ISR Israel	1		1	1	3
8.		ARM Armenia	1		1		1
9.		LBN Lebanon	1				
9.		SWE Sweden	1				
11.		POL Poland		3	4	3	1
12.		CRO Croatia		2	1	1	
13.		MDA Republic of Moldova		2		2	2
14.		AZE Azerbaijan		1	2	1	1
15.		MNE Montenegro		1			
16.		BEL Belgium			2		
17.		GBR Great Britain			1	1	
17.		GRE Greece			1	1	
19.		FIN Finland			1		1
20.		DEN Denmark			1		
20.		IRL Ireland			1		
20.		SLO Slovenia			1		
23.		IJF International Judo Federation				1	
23.		KAZ Kazakhstan				1	
23.		KGZ Kyrgyzstan				1	
26.		CAN Canada					1

Official person:



# Statistics

Tallinn European Open 2026, 6-7 Jun 2026

# Statistics

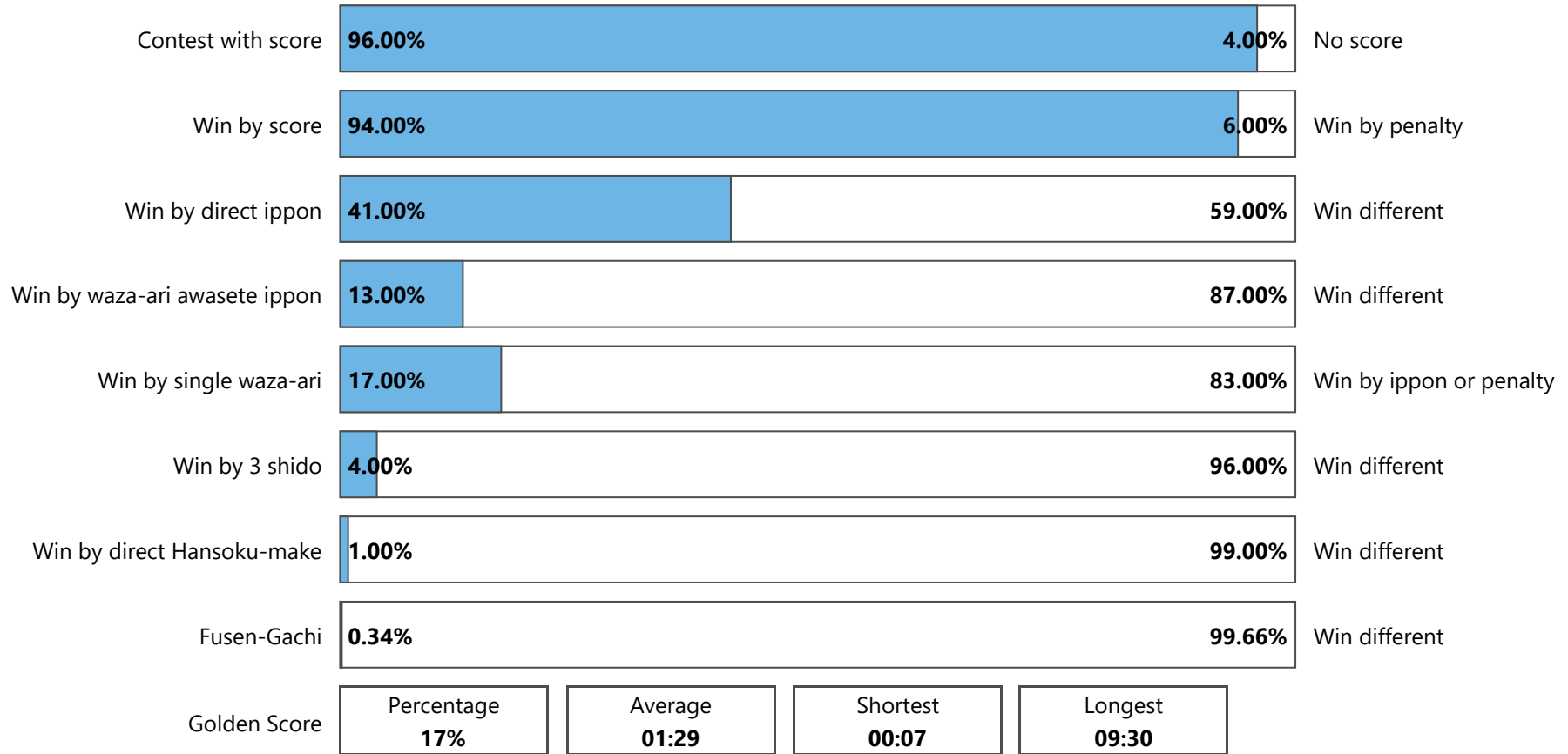



# Statistics

Tallinn European Open 2026, 6-7 Jun 2026

# Statistics

	-60	-66	-73	-81	-90	-100	+100	M	-48	-52	-57	-63	-70	-78	+78	W	Total
Competitors	17	34	44	33	23	13	9	<b>173</b>	16	11	18	7	14	9	4	<b>79</b>	<b>252</b>
Contests	20	37	47	36	26	16	12	<b>194</b>	19	14	21	9	17	12	4	<b>96</b>	<b>290</b>
Wins by Score	20	36	47	33	23	16	12	<b>187</b>	16	13	20	9	16	11	2	<b>87</b>	<b>274</b>
Wins by Score %	100	97	100	92	88	100	100	<b>96.39</b>	84	93	95	100	94	92	50	<b>90.62</b>	<b>94</b>
Wins by Penalty	0	1	0	3	3	0	0	<b>7</b>	3	1	1	0	1	1	2	<b>9</b>	<b>16</b>
Wins by Penalty %	0	3	0	8	12	0	0	<b>3.61</b>	16	7	5	0	6	8	50	<b>9.38</b>	<b>6</b>
Wins by direct Ippon %	40	38	45	36	42	31	58	<b>40.72</b>	32	36	52	44	59	25	25	<b>41.67</b>	<b>41</b>
Wins by Waza-ari Awasete Ippon %	10	19	13	25	8	12	0	<b>14.43</b>	11	7	10	0	12	25	0	<b>10.42</b>	<b>13</b>
Wins by Waza-ari %	30	11	15	17	15	12	33	<b>17.01</b>	16	21	14	11	24	8	0	<b>15.62</b>	<b>17</b>
Wins by Yuko %	20	30	28	14	23	44	8	<b>24.23</b>	26	29	19	44	0	33	25	<b>22.92</b>	<b>24</b>
Wins by 3 Shido for opponent %	0	3	0	8	12	0	0	<b>3.61</b>	5	7	5	0	0	8	50	<b>6.25</b>	<b>4</b>
Wins by direct Hansoku-make %	0	0	0	0	0	0	0	<b>0</b>	11	0	0	0	6	0	0	<b>0</b>	<b>1</b>
Double HSK %	0	0	0	0	0	0	0	<b>0</b>	0	0	0	0	0	0	0	<b>0</b>	<b>0</b>
All positive Scores (Yuko + Waza-ari + direct Ippon)	31	64	79	66	43	25	17	<b>325</b>	28	21	35	11	33	23	3	<b>154</b>	<b>479</b>
Average Scores per contests	0	3	0	8	12	0	0	<b>1.68</b>	16	7	5	0	6	8	50	<b>1.60</b>	<b>6</b>
Contests with score %	100	97	100	94	92	100	100	<b>97.42</b>	89	93	95	100	100	92	50	<b>92.71</b>	<b>96</b>
All penalties (Shido + HSK)	31	43	63	63	29	28	16	<b>273</b>	23	20	26	13	22	17	10	<b>131</b>	<b>404</b>
Average penalty per contest	1.55	1.16	1.34	1.75	1.12	1.75	1.33	<b>1.41</b>	1.21	1.43	1.24	1.44	1.29	1.42	2.5	<b>1.36</b>	<b>1.39</b>
Contests with only penalty %	0	3	0	6	8	0	0	<b>2.58</b>	11	7	5	0	0	8	50	<b>7.29</b>	<b>4</b>
Number of Osae-komi (Absolute)	8	9	11	10	5	5	4	<b>52</b>	7	4	9	2	7	3	0	<b>32</b>	<b>84</b>
Osae-komi no score %	50.0	11.11	18.18	40.0	80.0	20.0	50.0	<b>34.62</b>	14.29	0	22.22	0	42.86	33.33	0	<b>21.88</b>	<b>29.76</b>
Osae-komi Yuko %	0	33.33	27.27	0	0	20.0	25.00	<b>4.12</b>	28.57	0	11.11	0	28.57	0	0	<b>5.21</b>	<b>15.48</b>
Osae-komi Waza-ari %	25.00	33.33	36.36	60.0	20.0	20.0	0	<b>8.76</b>	28.57	25.00	33.33	0	14.29	66.67	0	<b>9.38</b>	<b>30.95</b>
Osae-komi Ippon %	25.00	22.22	18.18	0	0	40.0	25.00	<b>4.64</b>	28.57	75.00	33.33	100	14.29	0	0	<b>11.46</b>	<b>23.81</b>
Direct Hansoku-make	0	0	0	0	0	0	0	<b>0</b>	2	0	0	0	1	0	0	<b>3</b>	<b>3</b>
Fusen-gachi	0	0	1	0	0	0	0	<b>1</b>	0	0	0	0	0	0	0	<b>0</b>	<b>1</b>
Doctor call	0	0	0	0	0	0	0	<b>0</b>	0	0	0	0	0	0	0	<b>0</b>	<b>0</b>
Golden Score %	40	24	13	8	8	12	17	<b>16.49</b>	21	29	19	33	0	17	25	<b>18.75</b>	<b>17</b>
Golden Score Duration AVG	163.62	78.56	76	25	48	66	58.5	<b>90.38</b>	59.5	95.25	117.5	47	0	125.5	97	<b>87.67</b>	<b>89.4</b>
Golden Score Duration MAX	570	347	159	45	68	71	100	<b>570</b>	110	139	205	64	0	153	97	<b>205</b>	<b>570</b>



# Nations Overview

Tallinn European Open 2026, 6-7 Jun 2026

# Nations

Overview

			-60	-66	-73	-81	-90	-100	+10	M	-48	-52	-57	-63	-70	-78	+78	W	Total	Ref	D	
1.		ARM	Armenia	3	1	1			1	6								0	6	0	2	
2.		AUT	Austria			1				1			1					1	2	0	1	
3.		AZE	Azerbaijan							0	2	1	2	1	2	1	1	10	10	2	4	
4.		BEL	Belgium			3	1			4	1							1	5	1	1	
5.		BRN	Bahrain			1	1			2								0	2	0	0	
6.		CAN	Canada				1	1		2								0	2	0	0	
7.		CRO	Croatia		1			1	1	3					2	3		5	8	0	6	
8.		DEN	Denmark			1				1				1				1	2	1	1	
9.		ESP	Spain	2	1		1			4		1						1	5	1	1	
10.		EST	Estonia	2	3	2	5	2	3	2	19			3			1	4	23	0	12	
11.		FIN	Finland			5	1	2	1	9					1			1	10	0	2	
12.		FRA	France		3		3			6	2		2		1	1		6	12	1	6	
13.		GBR	Great Britain	1		3	2	1		1	8	1	1					2	10	2	2	
14.		GRE	Greece					1		1	2							0	2	0	0	
15.		HKG	Hong Kong, China							0	3	3	1					7	7	1	1	
16.		IRL	Ireland			1		1		2								0	2	0	1	
17.		ISR	Israel	1	8	3	4	3		19			1		2			3	22	0	1	
18.		ITA	Italy	2	3	1	1	1	2	10	2	1	1		3			7	17	0	2	
19.		KAZ	Kazakhstan	1	1	2	1		1	6	1							1	7	0	2	
20.		KGZ	Kyrgyzstan			1	1			2								0	2	0	1	
21.		LAT	Latvia			3	2	2	1	8			1		1			2	10	2	4	
22.		LBN	Lebanon							0						1		1	1	0	0	
23.		LTU	Lithuania		2	4	2			8								0	8	0	3	
24.		MDA	Republic of Moldova		2	4	1	1		8						1		1	9	0	1	
25.		MNE	Montenegro						2	2				1				1	3	0	1	
26.		NED	Netherlands				1			1								0	1	1	0	
27.		NOR	Norway							0			1					1	1	0	1	
28.		POL	Poland	2	2	4	1	1	1	11	3	2	3	2		2	1	13	24	2	6	
29.		SLO	Slovenia				1			1					1			1	2	0	1	
30.		SWE	Sweden		1			1		2				1				1	3	2	1	
31.		UKR	Ukraine	3	6	4	3	4	3	2	25		2	2	1	1	1	7	32	1	3	
32.		USA	United States of America					1		1								0	1	0	0	
				17	34	44	33	23	13	9	173	15	11	18	7	14	9	4	78	251	17	67

Total: 251 competitors from 32 countries and 3 continents



# Tallinn European Open 2026

Estonia, Tallin, 6-7 Jun 2026

**-60 kg**  
Men (17)

POOL A

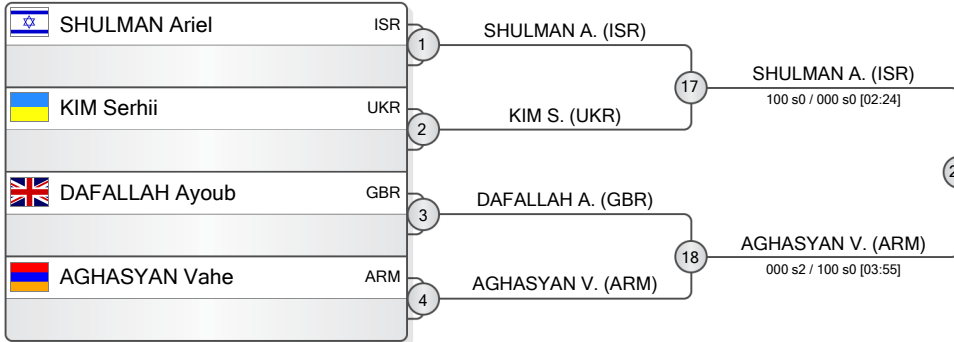

POOL B

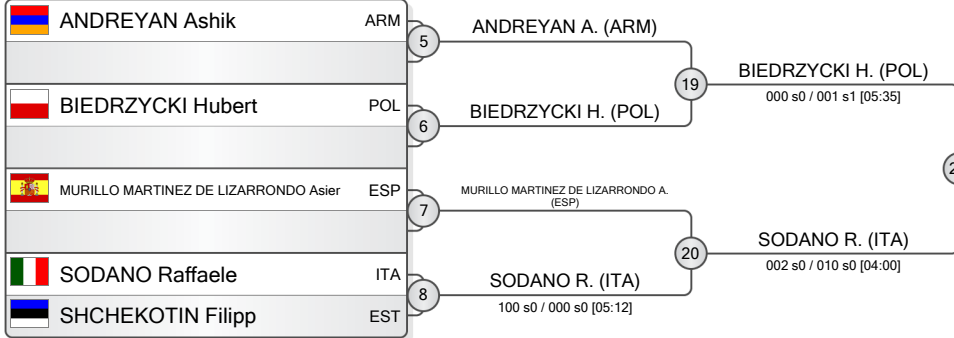

POOL C

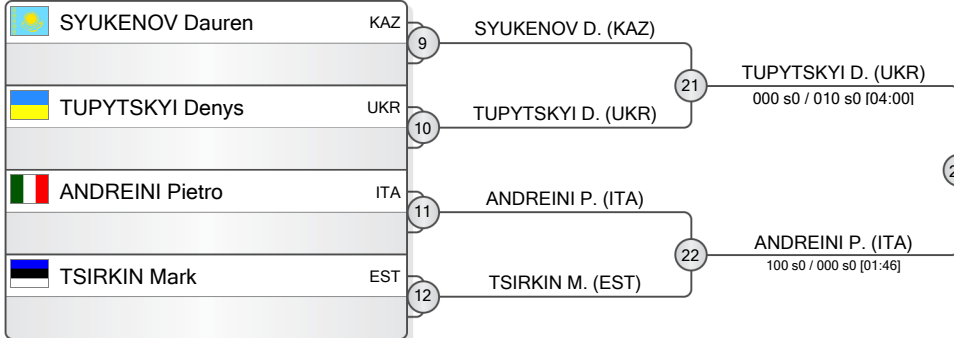

POOL D

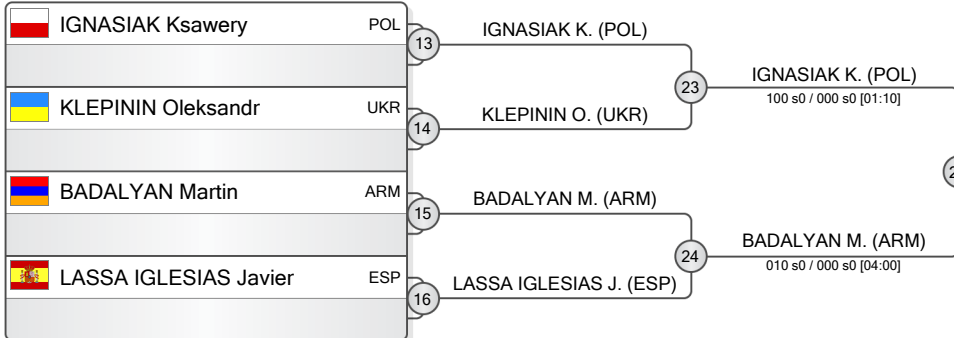

REPECHAGE

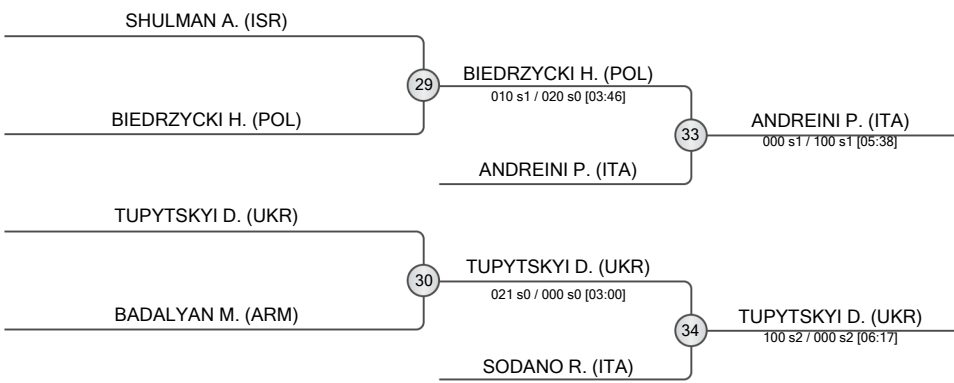

FINAL RESULTS	
1. AGHASYAN Vahe	ARM
2. IGNASIAK Ksawery	POL
3. ANDREINI Pietro	ITA
3. TUPYTSKYI Denys	UKR
5. BIEDRZYCKI Hubert	POL
5. SODANO Raffaele	ITA
7. SHULMAN Ariel	ISR
7. BADALYAN Martin	ARM





# Tallinn European Open 2026

Estonia, Tallin, 6-7 Jun 2026

**-66 kg**  
Men (34)

POOL A

1	CHERNOV Vadym (UKR)	33	CHERNOV V. (UKR)	100 s0 / 001 s0 [03:32]
2	MORALES MARTINEZ Jose Manuel (ESP)			
3	KLIMKIEWICZ Krzysztof (POL)	34	KOKOLAYEV M. (ISR)	011 s0 / 020 s0 [01:34]
4	KOKOLAYEV Matan (ISR)			
5	NINFO Federico (ITA)	35	NINFO F. (ITA)	001 s1 / 000 s1 [04:00]
6	LAVI Ori (ISR)			
7	FUNG Devid (UKR)	36	MOREAU M. (FRA)	110 s0 / 000 s0 [01:47]
8	MOREAU Mathias (FRA)			

POOL B

9	KLACAR Dani (CRO)	37	KLACAR D. (CRO)	010 s0 / 000 s1 [04:00]
10	ALHAZOV Tal (ISR)			
11	TIRSINA Alexandru (MDA)	38	CYSIQUE W. (FRA)	000 s2 / 010 s2 [04:00]
12	CYSIQUE William (FRA)			
13	VISKOV Nazar (UKR)	39	VISKOV N. (UKR)	001 s1 / 000 s0 [04:10]
14	BIGAMBAYEV Tabyldy (KAZ)			
15	RUBINSTEIN Roy (ISR)	40	RUBINSTEIN R. (ISR)	001 s2 / 000 s1 [04:00]
16	KONT Carl-Gustav (EST)			

POOL C

17	GUTMAN Guy (ISR)	41	GUTMAN G. (ISR)	020 s0 / 000 s0 [02:45]
18	NORKEVICIUS Matas (LTU)			
19	RIPSATER Isac (SWE)	42	MARTIROSIAN H. (UKR)	000 s2 / 001 s1 [04:42]
20	MARTIROSIAN Hahik (UKR)			
21	ABRAHAMYAN Davit (ARM)	43	CARGNELUTTI F. (ITA)	010 s1 / 011 s0 [04:07]
22	CARGNELUTTI Francesco (ITA)			
23	JAKIMOV Edward (EST)	44	JAKIMOV E. (EST)	100 s0 / 000 s0 [00:47]
24	SHAI Ori Gal (ISR)			

POOL D

25	DE LUCA Alessio (ITA)	45	DE LUCA A. (ITA)	100 s0 / 000 s0 [00:52]
26	MAN Omer (ISR)			
27	MORARU Alexandru (MDA)	46	BOUDA R. (FRA)	000 s0 / 100 s0 [01:49]
28	MARANDIAN Karo (UKR)			
29	BOUDA Romaric Wend-Yam (FRA)	47	DUBINA H. (UKR)	000 s3 / 100 s2 [04:58]
30	FIKS Eran (ISR)			
31	DUBINA Hlib (UKR)	48	FITYKA M. (POL)	101 s0 / 001 s0 [03:39]
32	FITYKA Mateusz (POL)			
33	JAKIMOV Robert (EST)			

REPECHAGE

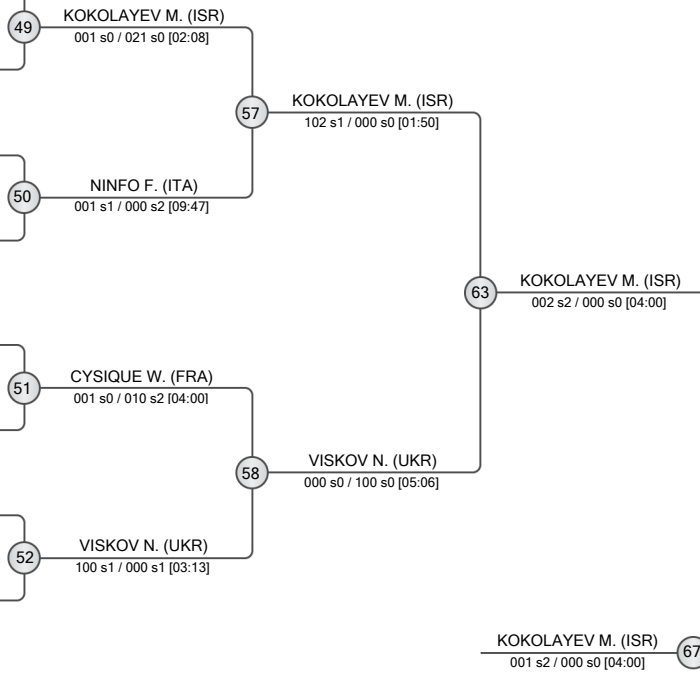
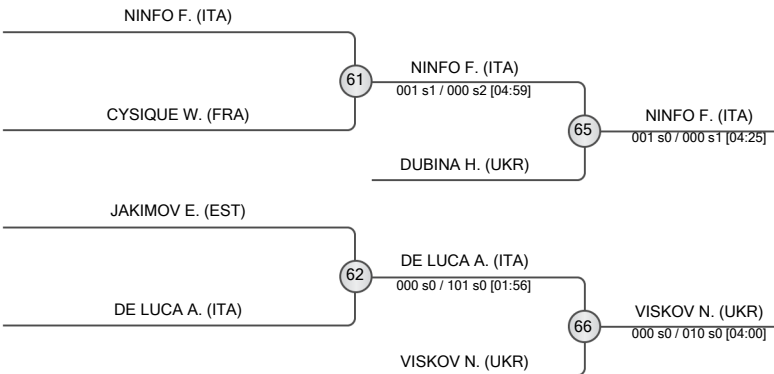

FINAL RESULTS	
1.	KOKOLAYEV Matan (ISR)
2.	MARTIROSIAN Hahik (UKR)
3.	NINFO Federico (ITA)
3.	VISKOV Nazar (UKR)
5.	DUBINA Hlib (UKR)
5.	DE LUCA Alessio (ITA)
7.	CYSIQUE William (FRA)
7.	JAKIMOV Edward (EST)





# Tallinn European Open 2026

Estonia, Tallin, 6-7 Jun 2026

**-73 kg**  
Men (44)

POOL A

IRE	GREEN Joshua	IRL
FIN	TAAVITSAINEN Jesper	FIN
GBR	LE MARE Harry	GBR
UKR	NEBOTOV Serhii	UKR
LTU	KARALEVICIUS Zygimantas	LTU
KAZ	KENESKAN Yernar	KAZ
MDA	VIERU Denis	MDA
BEL	LENAERTS Nathan	BEL
POL	LOSKA Olaf	POL
LAT	NASIROVS Abulfazs	LAT
KGZ	DZHUMABEKOV Yrskeldi	KGZ

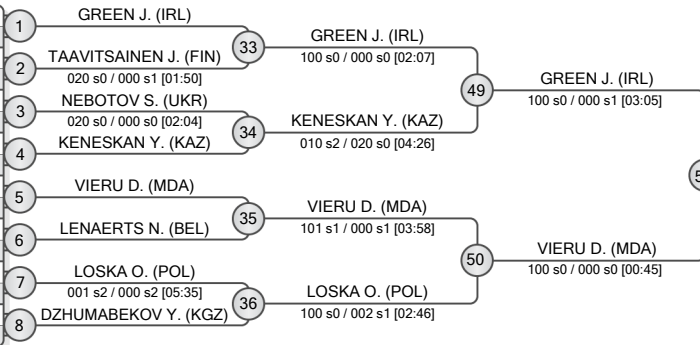

POOL B

DEN	ERRBOE Morgan	DEN
FIN	NIEMENKARI Kasper	FIN
LAT	BULAJEVs Maksims	LAT
ISR	GINER Oron	ISR
UKR	IADOV Bogdan	UKR
ITA	BOSIS Federico	ITA
EST	TRILLJARV Matheas	EST
POL	LEMPICKI Kacper	POL
MDA	ROSCA Serghei	MDA
ARM	TOROSYAN Artak	ARM
LTU	UCKURONIS Maksimiljan	LTU

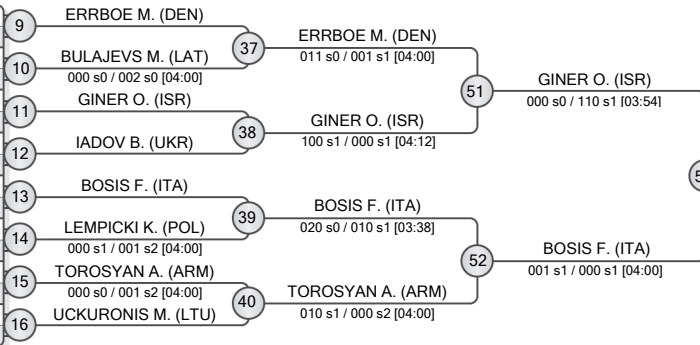

POOL C

BRN	ALOEV Mukhamed	BRN
BEL	UMAYEV Abdul Malik	BEL
FIN	VEIJOLA Iikka	FIN
LTU	RAULUSONIS Augis	LTU
KAZ	ALZHANOV Magzhan	KAZ
UKR	HOLOBORODKO Mykyta	UKR
MDA	VESTE Andrian	MDA
POL	MICHNA Kamil	POL
EST	PERTELSON Oscar	EST
ISR	ITSHAK Yonatan	ISR
GBR	STEVENS Adam	GBR

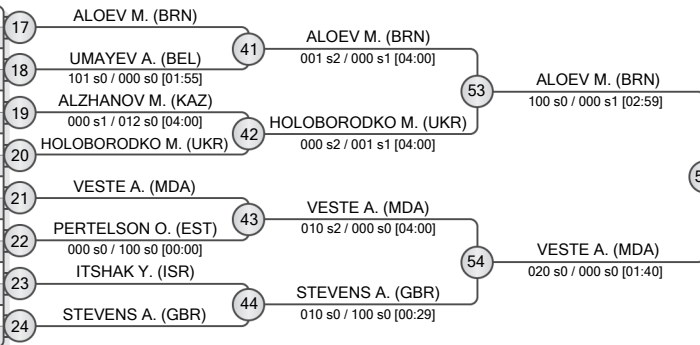

POOL D

MDA	CROITORU Renat	MDA
LTU	BROGA Simonas	LTU
FIN	KUJANHAARA Joonatan	FIN
ISR	BARSHESHET Eylon	ISR
LAT	DE ANGELIS Anthony	LAT
BEL	MARINX Ray	BEL
AUT	AUST Phillip	AUT
POL	BOGDANSKI Teodor	POL
UKR	DOKTOROV Denys	UKR
GBR	JACKSON Thomas	GBR
FIN	KORHONEN Roope	FIN

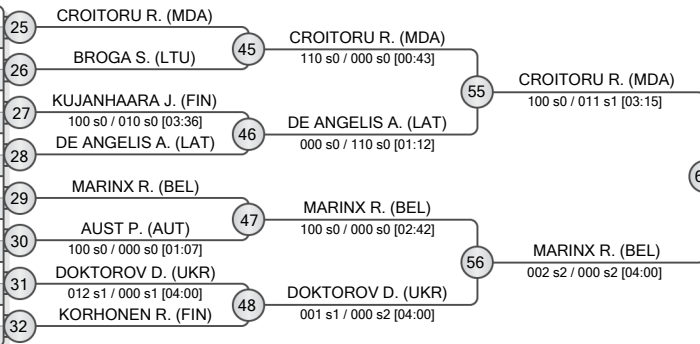

REPECHAGE



FINAL RESULTS	
1.	ALOEV Mukhamed BRN
2.	BOSIS Federico ITA
3.	GREEN Joshua IRL
4.	MARINX Ray BEL
5.	CROITORU Renat MDA
6.	VIERU Denis MDA
7.	GINER Oron ISR
7.	VESTE Andrian MDA





# Tallinn European Open 2026

Estonia, Tallin, 6-7 Jun 2026

**-81 kg**  
Men (33)

POOL A

1	GASANOV G. (BRN)
2	NEUMANN E. (GBR)
3	KASESALU C. (EST)
4	BADASH I. (ISR)
5	NEYOLOV A. (CAN)
6	PLOSTNIEKS R. (LAT)
7	MAKINEN O. (FIN)
8	URALOV O. (KAZ)

POOL B

9	DIKAJEV S. (EST)
10	BAZTAN MERCHAN I. (ESP)
11	KORCHEMLIUK S. (UKR)
12	JEAN P. (FRA)
13	ZHUMANAZAROV R. (KGZ)
14	HABZO A. (ISR)
15	ZULYS A. (LTU)
16	KROL D. (POL)

POOL C

17	PELLIGRA V. (ITA)
18	RISTMAE J. (EST)
19	SNIJTERS T. (NED)
20	GRIBINET C. (MDA)
21	TYRRELL R. (GBR)
22	MALONKIN B. (UKR)
23	ARIE O. (ISR)
24	GIGLI S. (FRA)

POOL D

25	HERKOVIC N. (SLO)
26	ARGOV O. (ISR)
27	JOLKIN N. (EST)
28	GAZALOEV M. (BEL)
29	OTMANE L. (FRA)
30	KALNINS P. (LAT)
31	VITKAUSKAS K. (LTU)
32	PRANGLI A. (EST)

REPECHAGE

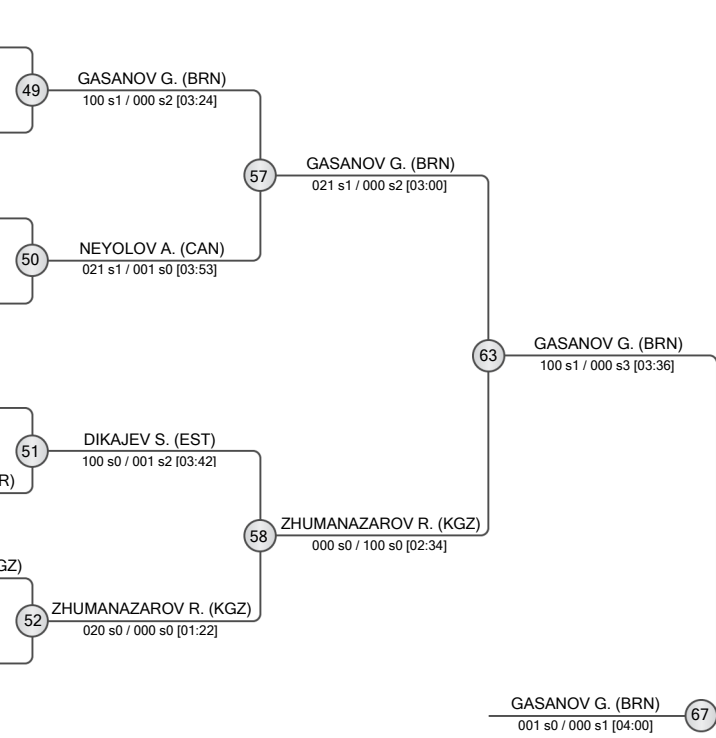
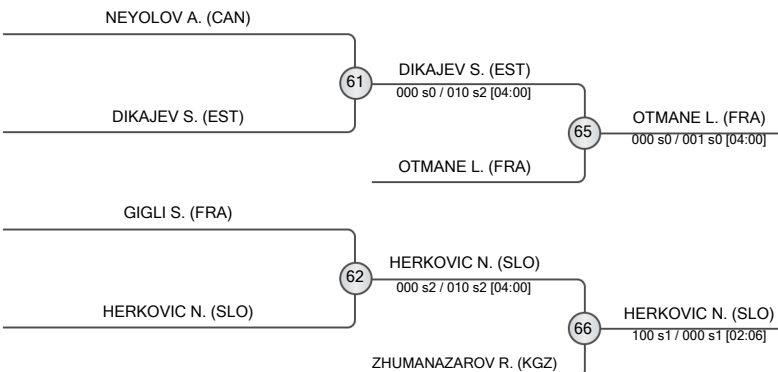

### FINAL RESULTS

1. GASANOV Gadzhidavud BRN
2. GRIBINET Ciprian MDA
3. OTMANE Luca FRA
3. HERKOVIC Nace SLO
5. DIKAJEV Saad EST
6. ZHUMANAZAROV Ratbek KGZ
7. NEYOLOV Artem CAN
7. GIGLI Sacha FRA





# Tallinn European Open 2026

Estonia, Tallin, 6-7 Jun 2026

**-90 kg**  
**Men (23)**

**POOL A**

	MYLONELIS Athanasios	GRE
	HRYCHAN Artem	UKR
	BEN HAROCH Segev	ISR
	MIKUCKIS Francis	LAT
	ROGALSKI Oskar	POL

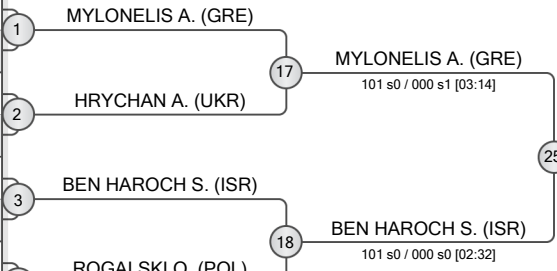

**POOL B**

	KUTENKOV Ivan	UKR
	MAOR Gal	ISR
	TALTS Rasmus	EST
	GLEESON Bearach	IRL
	ARTICOLO Danilo	ITA
	YLIRUUSI Teo	FIN

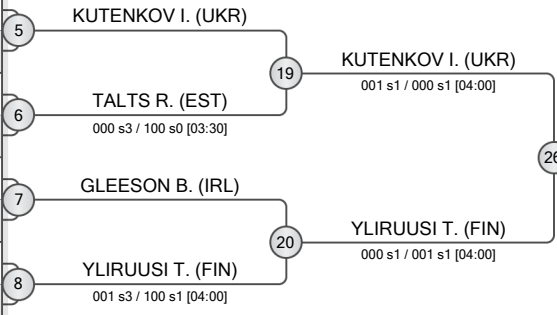

**POOL C**

	BUBYR Artem	UKR
	SEY Jared	GBR
	PLOSTNIEKS Eduards	LAT
	MRKOVIC Lovre	CRO
	CHYZHEVSKYI Ghenadi	MDA
	SALEM Omer	ISR

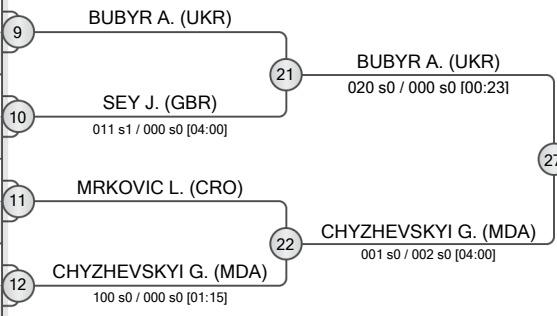

**POOL D**

	KANEVETS Artur	FIN
	BOUTON Ian	USA
	HEDENBLAD Joel	SWE
	GARAND Alec	CAN
	KOMIN Kirill	EST
	TOKHTAMYSH Oleksandr	UKR

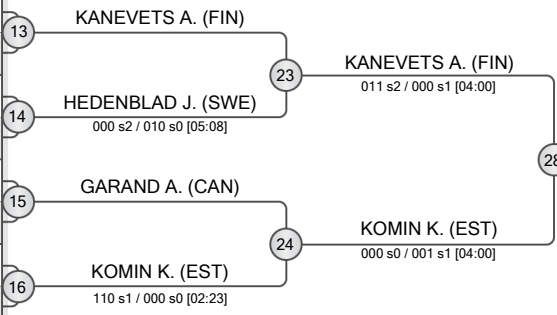

**REPECHAGE**

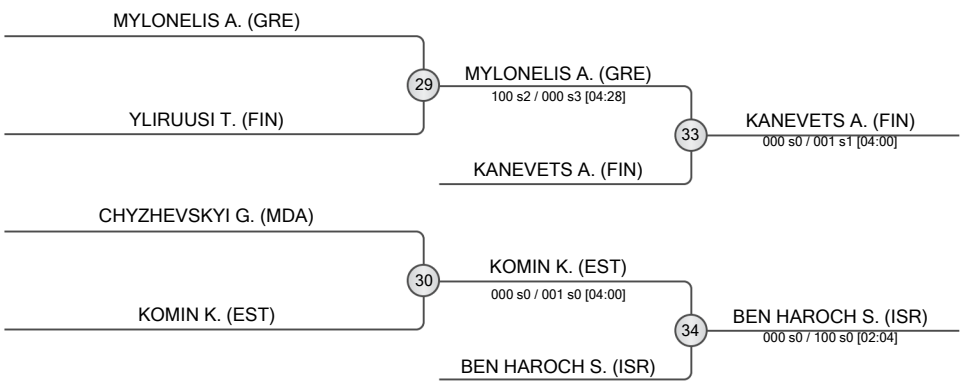

FINAL RESULTS	
1. BUBYR Artem	UKR
2. KUTENKOV Ivan	UKR
3. KANEVETS Artur	FIN
3. BEN HAROCH Segev	ISR
5. MYLONELIS Athanasios	GRE
5. KOMIN Kirill	EST
7. YLIRUUSI Teo	FIN
7. CHYZHEVSKYI Ghenadi	MDA





# Tallinn European Open 2026

Estonia, Tallin, 6-7 Jun 2026

**-100 kg**  
Men (13)

**POOL A**

	DUNIAMALIEV Zaur	UKR
	WESTERMARCK Pyry	FIN
	NILLER Jaan	EST

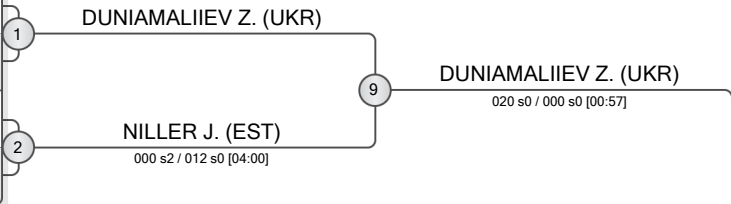

**POOL B**

	VARES Jakob	EST
	BUTIJER Borna	CRO
	PERNA Kevyn	ITA
	VALIEIEV Tymur	UKR

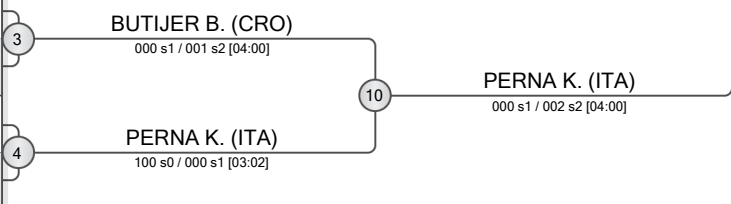

**POOL C**

	DUINOVS Maksims	LAT
	WALENCIAK Marcin	POL
	KOORT Ken-Kermo	EST

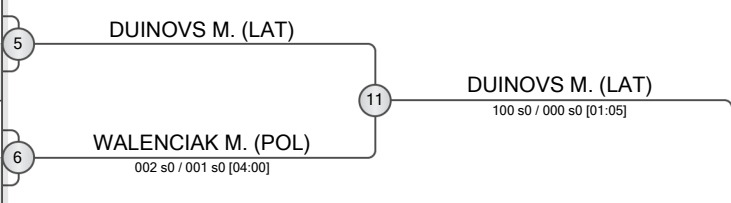

**POOL D**

	CARLETTI Jean	ITA
	KARAPETYAN Gor	ARM
	RIPKO Ivan	UKR

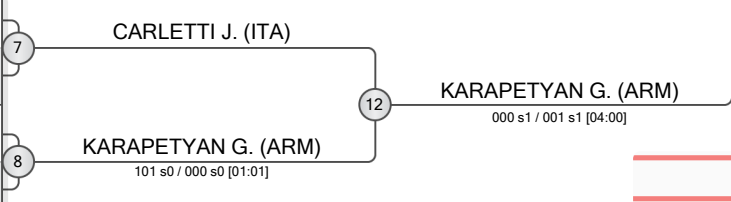

**REPECHAGE**

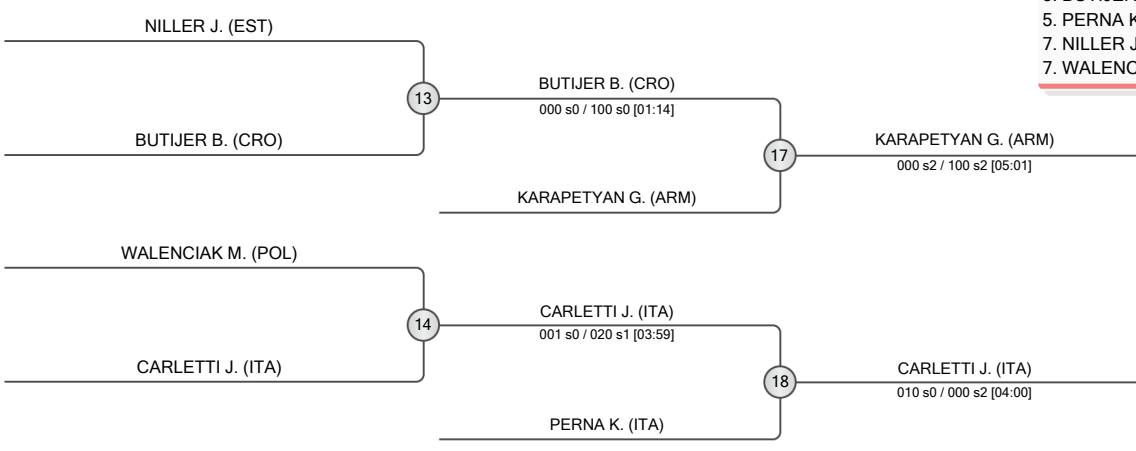

FINAL RESULTS		
1.	DUINOVS Maksims	LAT
2.	DUNIAMALIEV Zaur	UKR
3.	KARAPETYAN Gor	ARM
3.	CARLETTI Jean	ITA
5.	BUTIJER Borna	CRO
5.	PERNA Kevyn	ITA
7.	NILLER Jaan	EST
7.	WALENCIAK Marcin	POL





# Tallinn European Open 2026

Estonia, Tallin, 6-7 Jun 2026

**+100 kg**  
Men (9)

POOL A

	MASAK Marek-Adrian	EST
	SERIKOV Ardak	KAZ
	MAIBORODA Ivan	UKR

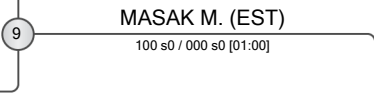
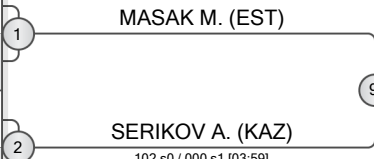

POOL B

	PAPANIKOLAOU Panagiotis	GRE
	PEKOVIC Jovan	MNE

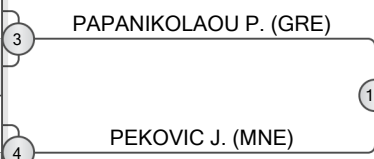

POOL C

	KOVINIC Stefan	MNE
	KIRNA Kabriel	EST

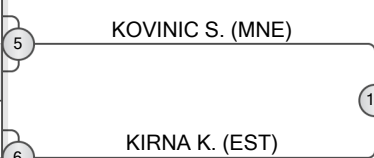

POOL D

	EDE Daniel	GBR
	YAROSHENKO Fedir	UKR

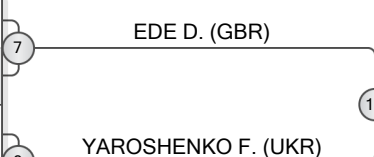

REPECHAGE

SERIKOV A. (KAZ)	PEKOVIC J. (MNE)
KIRNA K. (EST)	EDE D. (GBR)

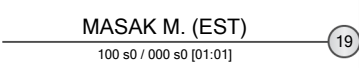
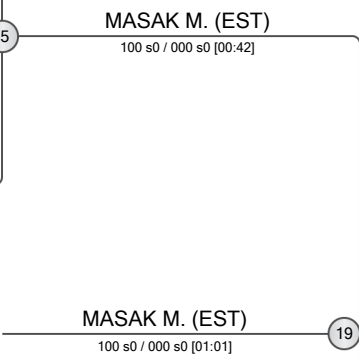
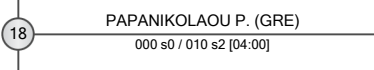
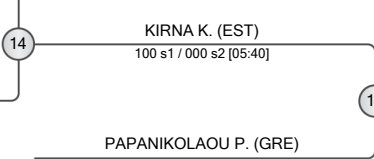

FINAL RESULTS		
1.	MASAK Marek-Adrian	EST
2.	KOVINIC Stefan	MNE
3.	YAROSHENKO Fedir	UKR
3.	PAPANIKOLAOU Panagiotis	GRE
5.	SERIKOV Ardak	KAZ
5.	KIRNA Kabriel	EST





# Tallinn European Open 2026

Estonia, Tallin, 6-7 Jun 2026

**-48 kg**  
Women (16)

**POOL A**

	HAMIDOVA Shafag	AZE
	LEPP Zeynab	IJF
	WOZNIAK Zuzanna	POL
	SIBILLE Victoria	BEL

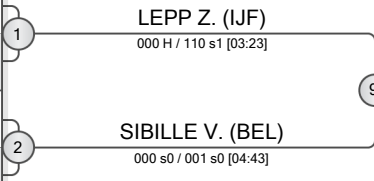

**POOL B**

	ANNIS Morgane	FRA
	TAGAY Symbat	KAZ
	IOVINO Anna	ITA
	TANG Suet Yiu	HKG

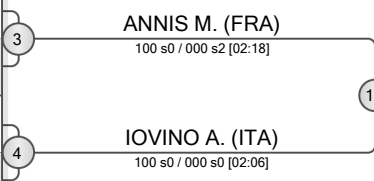

**POOL C**

	HO Lok Yi	HKG
	TCKAEVA Diana	AZE
	SLAZOK Wiktoria	POL
	MERMET Clara	FRA

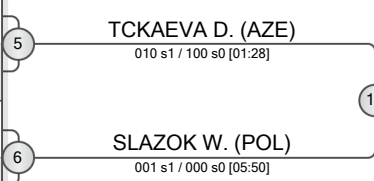

**POOL D**

	WONG Ka Lee	HKG
	GUARDUCCI Elena	ITA
	SHAW Summer	GBR
	ONYSK Oliwia	POL

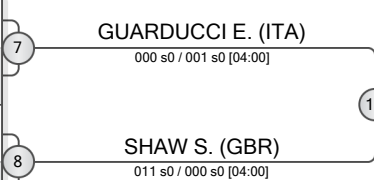

**REPECHAGE**

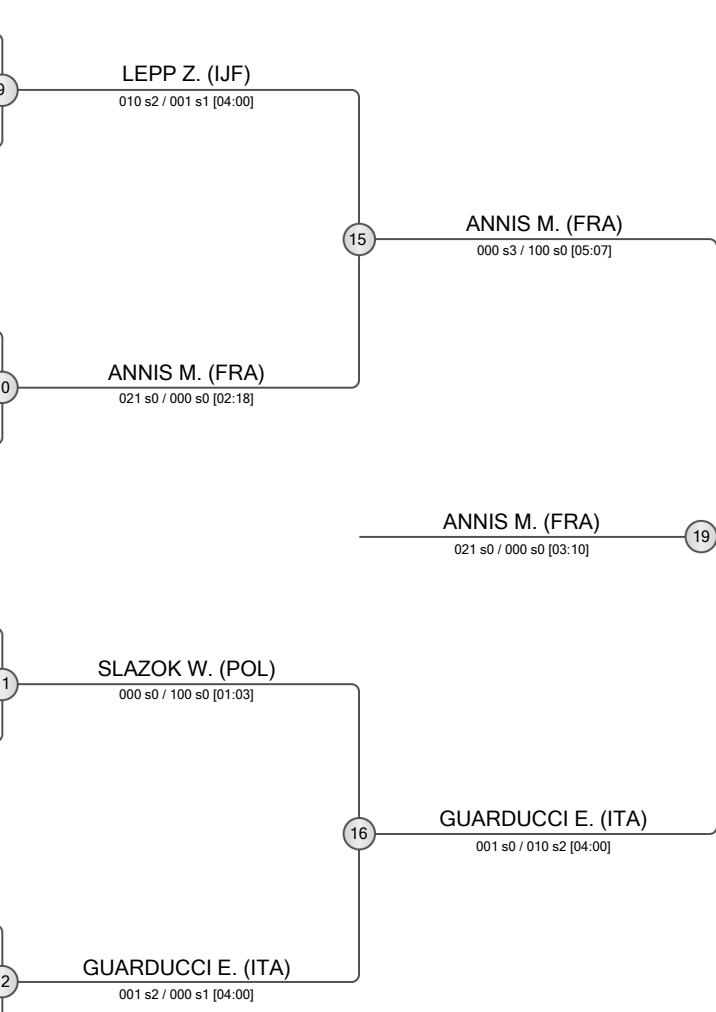

FINAL RESULTS		
1.	ANNIS Morgane	FRA
2.	GUARDUCCI Elena	ITA
3.	SIBILLE Victoria	BEL
3.	SHAW Summer	GBR
5.	SLAZOK Wiktoria	POL
5.	LEPP Zeynab	IJF
7.	IOVINO Anna	ITA
7.	TCKAEVA Diana	AZE





# Tallinn European Open 2026

Estonia, Tallin, 6-7 Jun 2026

**-52 kg**  
Women (11)

**POOL A**

	TSUI Shuk Ki	HKG
	LI Lok lu	HKG
	BORODINA Anna	UKR

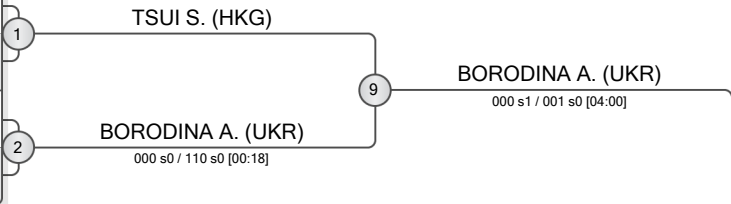

**POOL B**

	KLIMCZAK Kinga	POL
	BARBER Caitlin	GBR

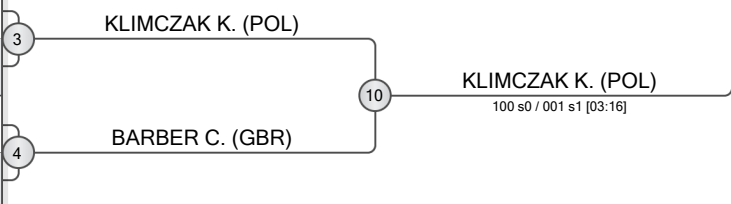

**POOL C**

	MAMMADALIYEVA Gultaj	AZE
	BEORLEGUI OSES Paula	ESP
	SHEVCHENKO Yelyzaveta	UKR

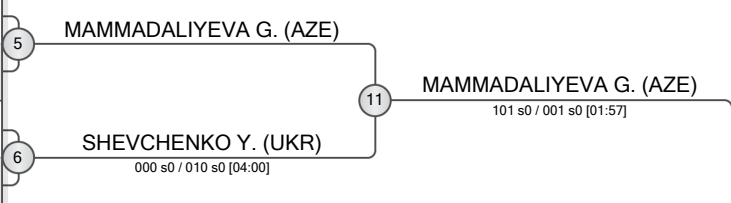

**POOL D**

	ROCCO Alessandra	ITA
	LAU Wai Sum	HKG
	GALEK Martyna	POL

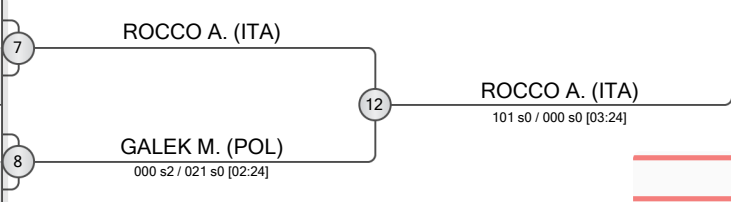

**REPECHAGE**

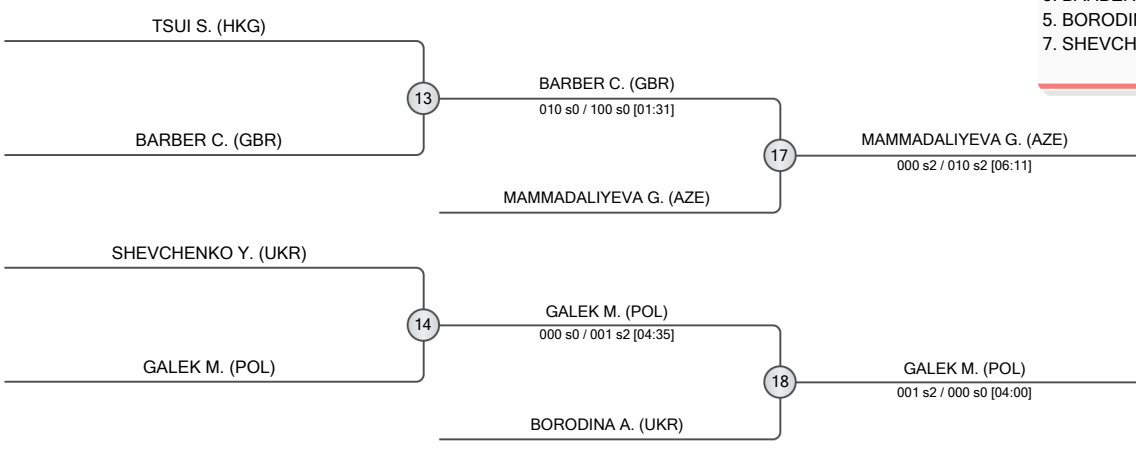

FINAL RESULTS		
1.	ROCCO Alessandra	ITA
2.	KLIMCZAK Kinga	POL
3.	MAMMADALIYEVA Gultaj	AZE
3.	GALEK Martyna	POL
5.	BARBER Caitlin	GBR
5.	BORODINA Anna	UKR
7.	SHEVCHENKO Yelyzaveta	UKR





# Tallinn European Open 2026

Estonia, Tallin, 6-7 Jun 2026

**-57 kg**  
Women (18)

POOL A

	SIENNICKA Karolina	POL
	MIHHAILOVA Darja	EST
	KOWALCZYK Julia	POL
	LAU Wan Lok	HKG

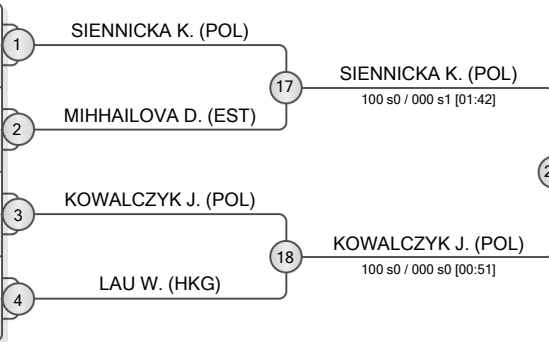

POOL B

	COTARD Maelenn	FRA
	SHYNKARENKO Inna	UKR
	BAYRAMOVA Gulnara	AZE
	MELIS Emma	FRA
	STOPPARI Emma	ITA

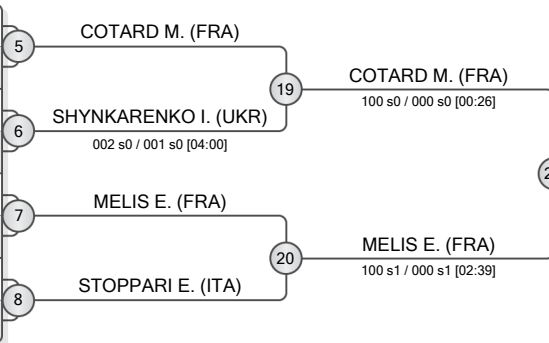

POOL C

	SOKIRJANSKA Anastasija	LAT
	TARKUS Merit	EST
	BAYRAMOVA Ulviyya	AZE
	ZAGURI Daniella	ISR

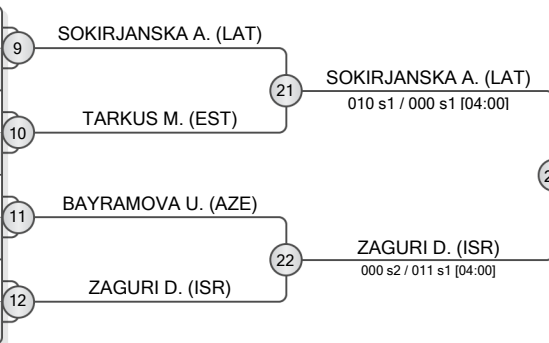

POOL D

	KALLINGER Laura	AUT
	NURM Anna Liisa	EST
	BULANDA Julia	POL
	CHYZHEVSKA Anastasiia	UKR
	BJOERAAS Elise	NOR

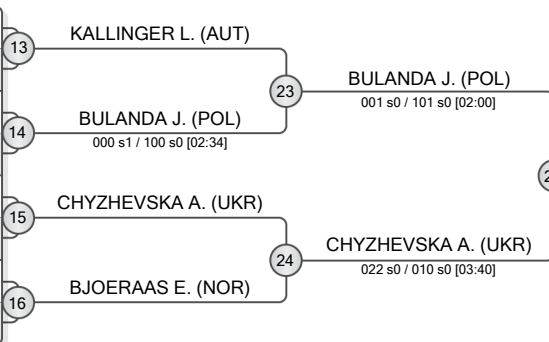

REPECHAGE

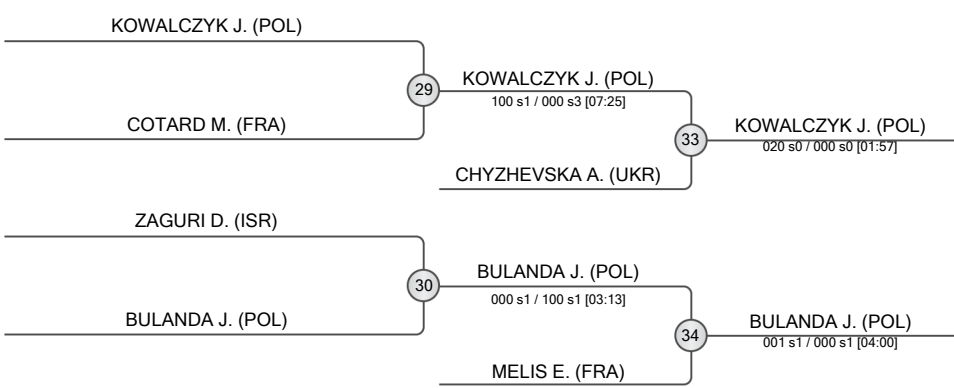

FINAL RESULTS	
1.	SOKIRJANSKA Anastasija
2.	SIENNICKA Karolina
3.	KOWALCZYK Julia
3.	BULANDA Julia
5.	CHYZHEVSKA Anastasiia
5.	MELIS Emma
7.	COTARD Maelenn
7.	ZAGURI Daniella





# Tallinn European Open 2026

Estonia, Tallin, 6-7 Jun 2026

**-63 kg**  
Women (7)

**POOL A**

ALIZADA Fidan AZE

**POOL B**

CHRISTENSEN Helene DEN  
 KUCHAVA Iia UKR

**POOL C**

BADURA Daniela POL  
 WATOREK Oliwia POL

**POOL D**

NURKOVIC Aisa MNE  
 BACKLUND Vilda SWE

**REPECHAGE**

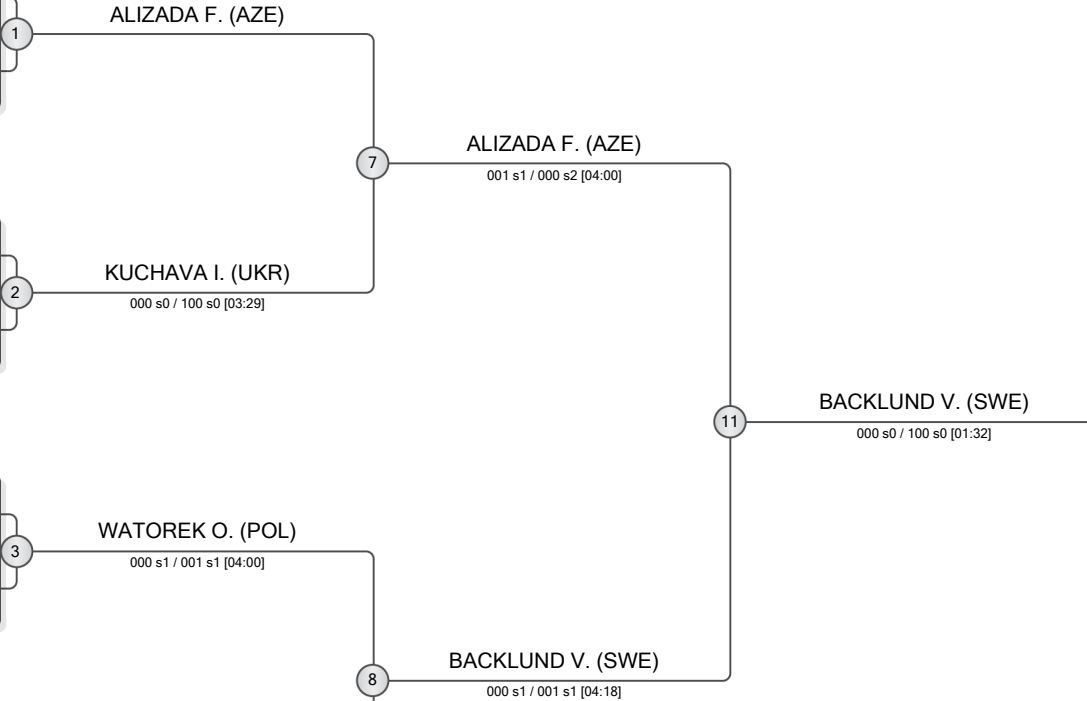
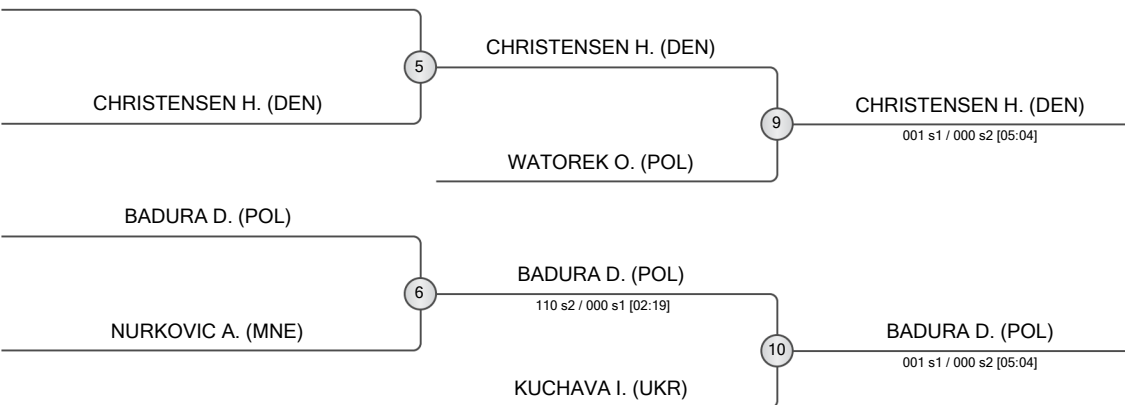

FINAL RESULTS	
1. BACKLUND Vilda	SWE
2. ALIZADA Fidan	AZE
3. CHRISTENSEN Helene	DEN
3. BADURA Daniela	POL
5. WATOREK Oliwia	POL
5. KUCHAVA Iia	UKR





# Tallinn European Open 2026

Estonia, Tallin, 6-7 Jun 2026

**-70 kg**  
Women (14)

**POOL A**

	CVJETKO Jana	CRO
	FRANZOSI Ludovica	ITA
	NIEMINEN Enna	FIN



**POOL B**

	GAJIC Jevgenija	SLO
	AMIHAI Shaked	ISR
	GARDASHKHANLI Aytaj	AZE
	MADDALONI Serena	ITA

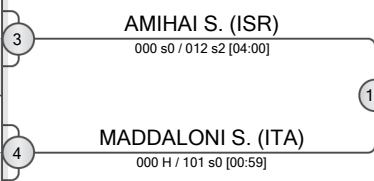

**POOL C**

	AGHAYEVA Sudaba	AZE
	SIMEOLI Nadia	ITA
	PONOMARJOVA Sofija	LAT

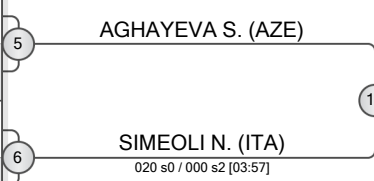

**POOL D**

	VIOLIC Andela	CRO
	CHABAL Mathilde	FRA
	RYTSKA Mariia	UKR
	BAR OR Gaya	ISR

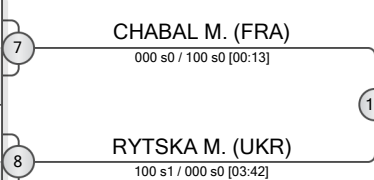

**REPECHAGE**

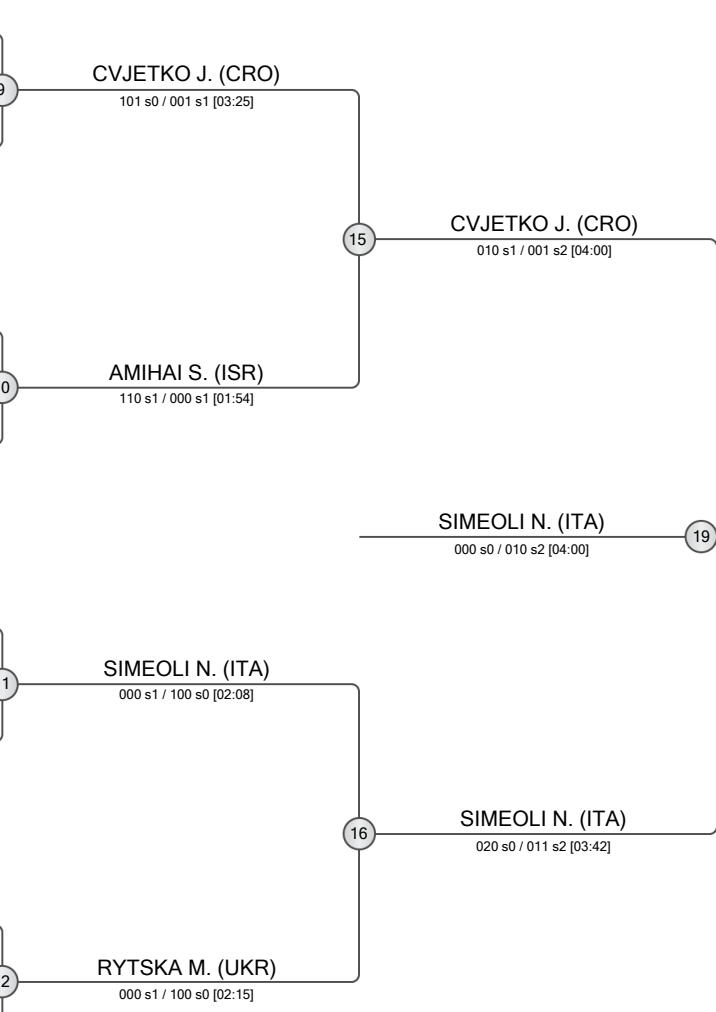
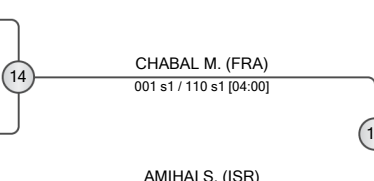
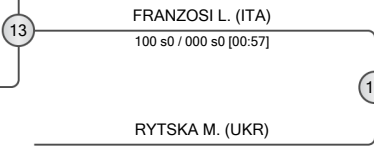
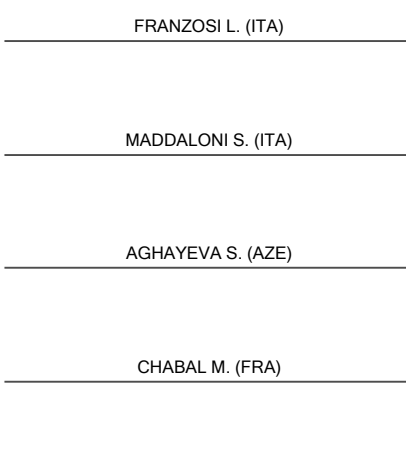

FINAL RESULTS		
1.	SIMEOLI Nadia	ITA
2.	CVJETKO Jana	CRO
3.	RYTSKA Mariia	UKR
3.	CHABAL Mathilde	FRA
5.	FRANZOSI Ludovica	ITA
5.	AMIHAI Shaked	ISR
7.	MADDALONI Serena	ITA





# Tallinn European Open 2026

Estonia, Tallin, 6-7 Jun 2026

**-78 kg**  
Women (9)

**POOL A**

	POSVITE Fanny Estelle	FRA
	WITKOWSKA Wanessa	POL
	KULIC Karla	CRO

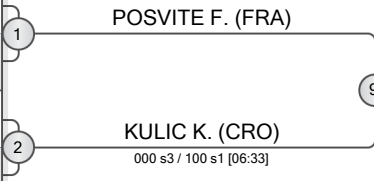

**POOL B**

	VUK Betty	CRO
	JAKUS Nika	CRO

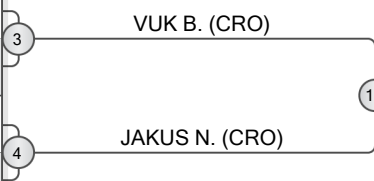

**POOL C**

	CHAYEB Aqulina	LBN
	TUREK Aleksandra	POL

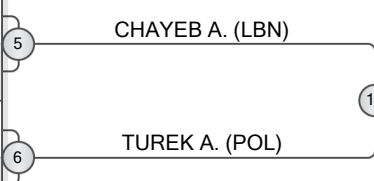

**POOL D**

	KAZAKOVA Anna	UKR
	AMIRLI Narmin	AZE

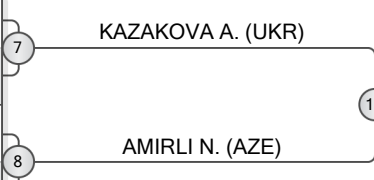

**REPECHAGE**

POSVITE F. (FRA)	JAKUS N. (CRO)	13	POSVITE F. (FRA) [020 s0 / 000 s0]
TUREK A. (POL)	AMIRLI N. (AZE)	14	AMIRLI N. (AZE) [000 s0 / 001 s0]

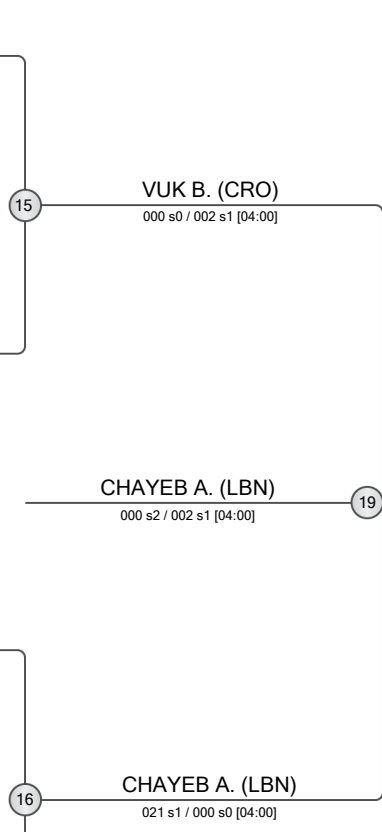
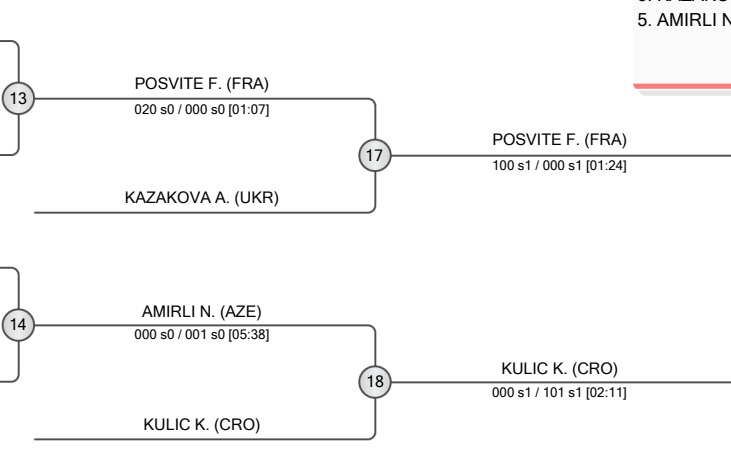

FINAL RESULTS		
1.	CHAYEB Aqulina	LBN
2.	VUK Betty	CRO
3.	POSVITE Fanny Estelle	FRA
3.	KULIC Karla	CRO
5.	KAZAKOVA Anna	UKR
5.	AMIRLI Narmin	AZE





# Tallinn European Open 2026

Estonia, Tallin, 6-7 Jun 2026

**+78 kg**  
Women (4)

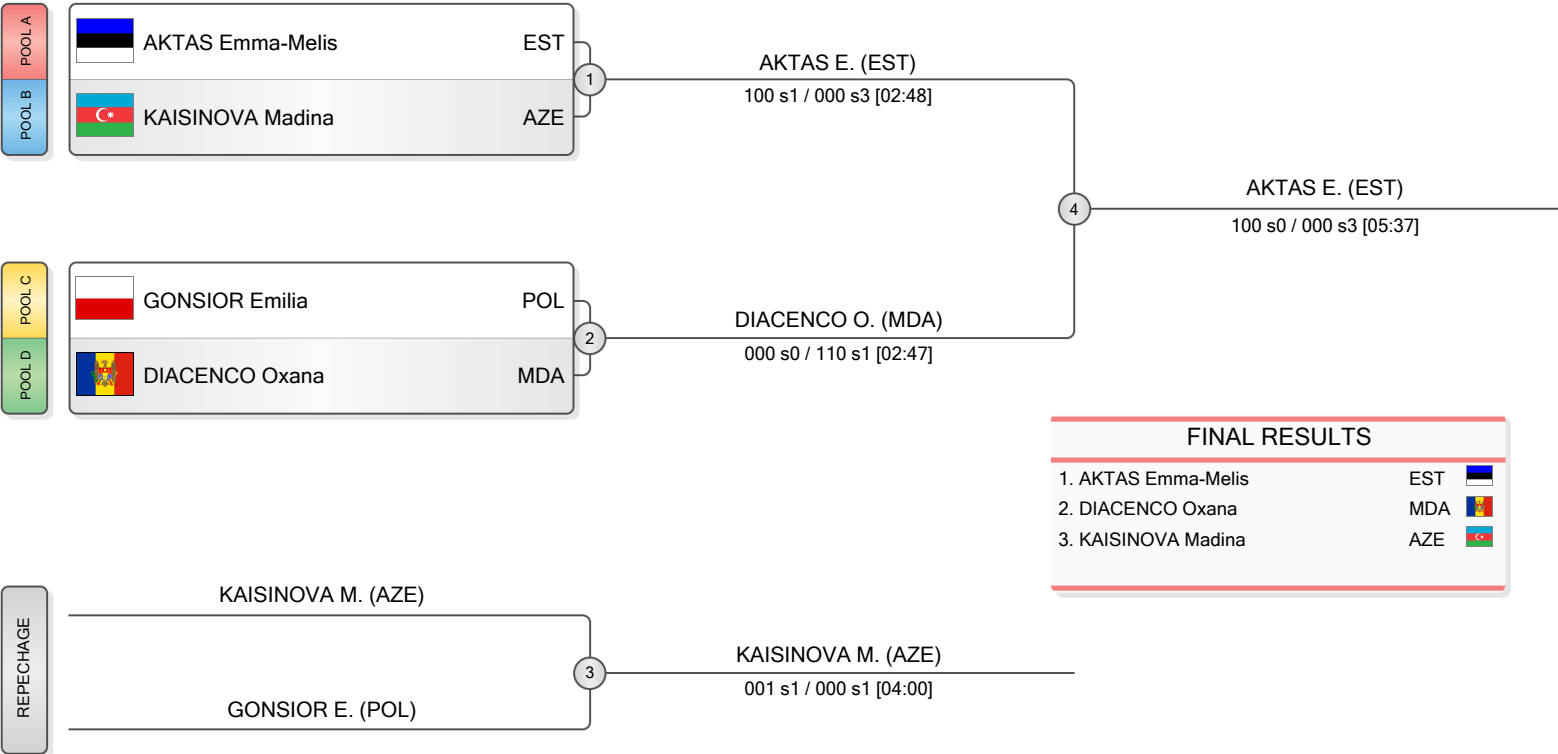

FINAL RESULTS		
1.	AKTAS Emma-Melis	EST
2.	DIACENCO Oxana	MDA
3.	KAISINOVA Madina	AZE

