



737 competitors from 35 nations

453 Men

284 Women

61.47%

38.53%

-50 kg	-55 kg	-60 kg	-66 kg	-73 kg	-81 kg	-90 kg	+90 kg	Men
50	63	89	76	62	59	34	20	453

-40 kg	-44 kg	-48 kg	-52 kg	-57 kg	-63 kg	-70 kg	+70 kg	Women
16	31	37	45	58	48	33	16	284

Continent	AJU	JUA	EJU	OJU	PJC	OTH	Total
Nations		2	33				35
Competitors		36	701				737

Schedule	Day 1	Day 2
Date	25 Apr	26 Apr
Start	09:00	09:00
End	17:40	15:50
Finals start	18:10	16:15
Finals end	20:00	22:00



-50 kg		
1	AGHAYEV Nihad	AZE
2	ABDUVAKHOBOV Mamurjon	UZB
3	DOGRU Suleyman	TUR
3	LAHRIFI Moulay-Mountasir	FRA
5	DOBROVLSKIS Mantas	LTU
5	HEIMANS Klaas	NED
7	ROLNICKI Alon	ISR
7	KELLER Aaron Joshua	GER

-55 kg		
1	KHUDIYEV Farid	AZE
2	TALIBOV Ibrahim	AZE
3	YUSUPOV Bobur	UZB
3	UYAR Celil	NED
5	PETROSINO Errico	ITA
5	SHREBERK Guy	ISR
7	PICKEL Daniel	ISR
7	ASILBEKOV Ramis Stalbekovich	KGZ

-60 kg		
1	SATTOROV Abubakr	UZB
2	AKHROROV Davlatbek	UZB
3	CORI Timeo	SUI
3	SANCES TURON Max	ESP
5	GOJAYEV Mikail	AZE
5	USINASHVILI Andro	GEO
7	ASGAROV Mehman	AZE
7	MARTZIANO Eyal	ISR

-66 kg		
1	COHEN Itamar	ISR
2	TODOROV Vladimir	BUL
3	GARAYEV Ilkin	AZE
3	KARIMOV Akromjon	UZB
5	PARLATI Marco	ITA
5	SVEC Hynek	CZE
7	GBINGBEHI Nathan	FRA
7	ATAMANIUK Rostyslav	GER

-73 kg		
1	MATUZNYI Dmytro	GER
2	MAMMADOV Sadig	AZE
3	USMONOV Bekhruzбек	UZB
3	STARING Eros	NED
5	HRISTOFOROV Bruno	EST
5	KILADZE Lazare	GER
7	CECI Emiliano	ITA
7	SCHUERER Hannes	GER

-81 kg		
1	SUNNATOV Samandar	UZB
2	HASANLI Aykhan	AZE
3	MEHDIYEV Amin	AZE
3	MAMMADOV Yagub	AZE
5	KILADZE Giga	GER
5	MATHUES Sid	BEL
7	KIKAS Aleksei	EST
7	PODKUJKO Igors	LAT

-90 kg		
1	BABAICENKO Tajus	LTU
2	AKHUNDOV Omar	AZE
3	YRYSOLOTOV Mukhammedali	KGZ
3	SCHEIBER Felix	AUT
5	ESHPUKATOV Jurabek	UZB
5	KOLOSOVS Dmitrijs	LAT
7	ALIYEV Nuraddin	AZE
7	BOOMKAMP Marinus	NED

+90 kg		
1	SKODA Melichar	CZE
2	APSALONS Aleksandrs	LAT
3	KAZIMOV Ruslan	AZE
3	BADEA Petru	ROU
5	SOM Samuel	FRA
5	BRUNNER Jan	CZE
7	IKMAN Den	ISR
7	BRAUSEWETTER Maarten	GER



-40 kg		
1	BARRAY Jade	FRA
2	SALAMOVA Sunay	AZE
3	SIROJIDDINOVA Iroda	UZB
3	TOKMAK Havva Sena	TUR
5	GAT MUALEM Avigayil	ISR
5	KARAKAZAN Elcin	TUR
7	GRACOVA Dominika	CZE
7	COSTA CABANA Candela	ESP

-44 kg		
1	YILMAZTURK Yagmur	TUR
2	LONGO Sofia	ITA
3	SEVKHANLI Parvin	AZE
3	BOLTABOEVA Dilafuz	UZB
5	CONI Sara	ITA
5	SOUBIELLE Maia	FRA
7	SOFFER Lih	ISR
7	VALVERDE DURAN Claudia	ESP

-48 kg		
1	HIKMATOVA Charos	UZB
2	GRIGORYAN Viktoria	BEL
3	STEFANIE Mamitantly Oceana	FRA
3	NOY Agam Sol	ISR
5	EYVAZLI Konul	AZE
5	BEERMANN Mia Marie	GER
7	NIJHUIS Jelena	NED
7	MANTAEVA Jasmina	AUT

-52 kg		
1	CHIRON Alexandra	MDA
2	VUKASOVIC Teodora	SRB
3	BOSKUP Aysenur	TUR
3	AGHAMIRZAZADE Narmin	AZE
5	VAN DE RIJZEN Lieve	NED
5	YAHAV Yali	ISR
7	WELLEKENS Amelie	BEL
7	FINDRIK Paula	CRO

-57 kg		
1	ALIMOVA Zuhra	UZB
2	NARRAIN Katharina	GER
3	KILIC Elif	TUR
3	KRONENTHAL Charlotte	GER
5	KHAZRATOVA Gulsanam	UZB
5	CHERNOVA Carina	POR
7	CEPELAKOVA Lucie	CZE
7	OUWERKERK Shayen	NED

-63 kg		
1	GIORDANO Valeria	ITA
2	BILEN Sevim Margaret	TUR
3	MATOUSKOVA Valentyna	CZE
3	RAMA Bleona	AUT
5	VAN SON Frederique	NED
5	LE TOUZE Lou	FRA
7	STOCK Luisa	GER
7	HUSEYNLI Zilan	AZE

-70 kg		
1	GOSSET Norah	FRA
2	OZBUDAK Done Melike	TUR
3	WOGERER Selina	AUT
3	KARAFFOVA Vanessa	CZE
5	JUMABAEVA Poshshajon	UZB
5	PILZ Amelie Fabienne	GER
7	KUCEROVA Anna	CZE
7	ZELL Amit	ISR

+70 kg		
1	SASSA-TATUKILA Therese-Grace	FRA
2	BALCI Hatice Tuana	TUR
3	WANDJI Maelyne	FRA
3	COULIBALY TOURE Ballalo	ESP
5	CHERKELIEVA Maria	BUL
5	MAGASSA FOFANA Sogona	ESP
7	PALERMO Elisa	ITA
7	ALIYEVA Zemfira	AZE



Medals

Berlin Millennium Team Cadet European Cup 2026, 25-26 Apr 2026

Medals

Nations: 20

#	Nation	1. Place	2. Place	3. Place	5. Place	7. Place
1.	UZB Uzbekistan	4	2	5	3	
2.	FRA France	3		3	3	1
3.	AZE Azerbaijan	2	5	6	2	4
4.	TUR Türkiye	1	3	4	1	
5.	GER Germany	1	1	1	4	5
6.	ITA Italy	1	1		3	2
7.	CZE Czechia	1		2	2	3
8.	ISR Israel	1		1	3	6
9.	LTU Lithuania	1			1	
10.	MDA Republic of Moldova	1				
11.	BEL Belgium		1		1	1
11.	LAT Latvia		1		1	1
13.	BUL Bulgaria		1		1	
14.	SRB Serbia		1			
15.	AUT Austria			3		1
16.	NED Netherlands			2	3	3
17.	ESP Spain			2	1	2
18.	KGZ Kyrgyzstan			1		1
19.	ROU Romania			1		
19.	SUI Switzerland			1		
21.	EST Estonia				1	1
22.	GEO Georgia				1	
22.	POR Portugal				1	
24.	CRO Croatia					1

Official person:



Statistics

Berlin Millennium Team Cadet European Cup 2026, 25-26 Apr 2026

Statistics

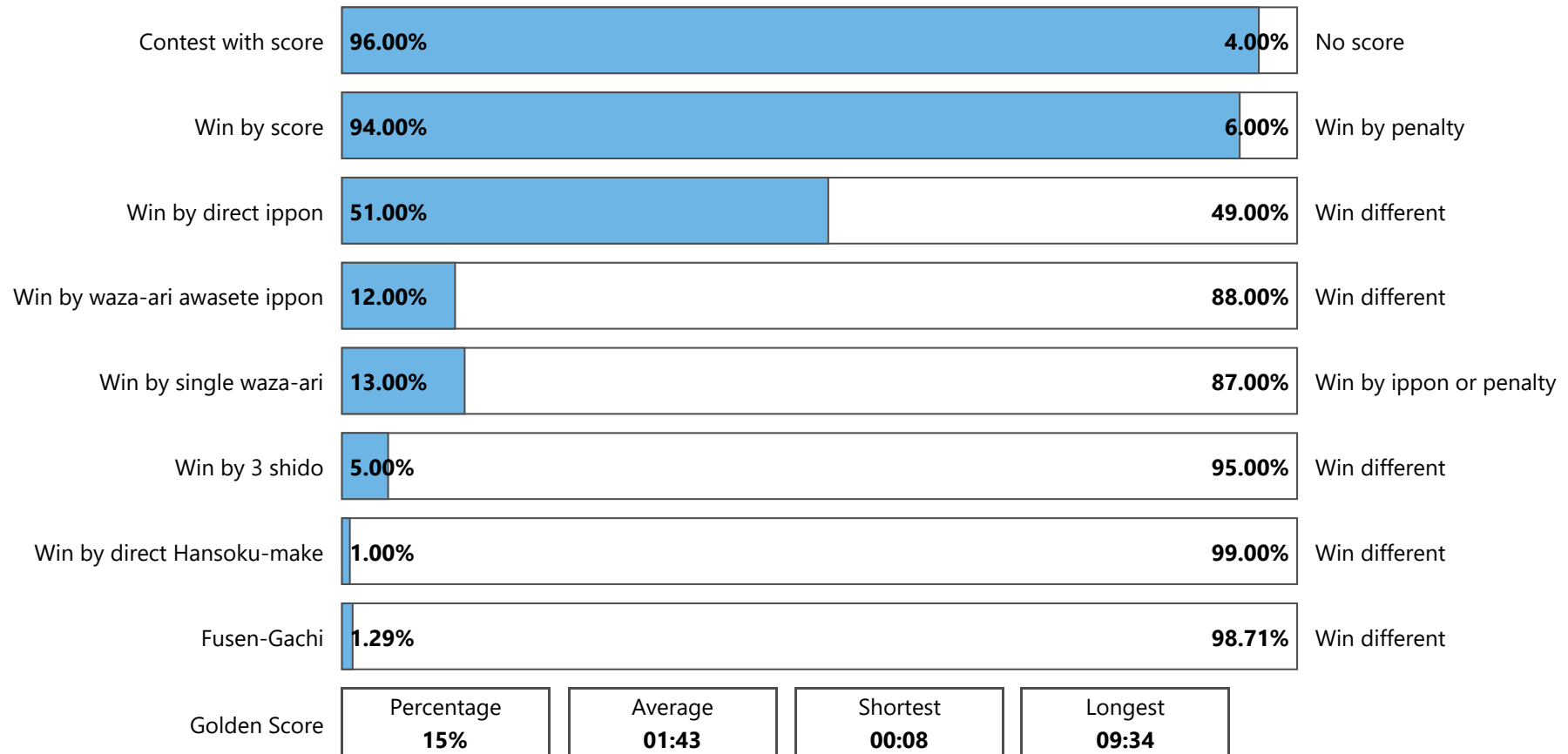



Statistics

Berlin Millennium Team Cadet European Cup 2026, 25-26 Apr 2026

Statistics

	-50	-55	-60	-66	-73	-81	-90	+90	M	-40	-44	-48	-52	-57	-63	-70	+70	W	Total
Competitors	50	63	89	76	62	59	34	20	453	16	31	37	45	58	48	33	16	284	737
Contests	64	77	108	91	77	72	45	27	561	23	41	48	56	72	62	44	23	369	930
Wins by Score	53	72	101	85	75	68	39	26	519	22	40	47	55	71	61	40	22	358	877
Wins by Score %	83	94	94	93	97	94	87	96	92.51	96	98	98	98	99	98	91	96	97.02	94
Wins by Penalty	11	5	7	6	2	4	6	1	42	1	1	1	1	1	1	4	1	11	53
Wins by Penalty %	17	6	6	7	3	6	13	4	7.49	4	2	2	2	1	2	9	4	2.98	6
Wins by direct Ippon %	39	44	61	48	58	50	47	70	51.69	43	37	58	64	47	47	43	57	49.86	51
Wins by Waza-ari Awasete Ippon %	9	13	10	8	12	17	18	19	12.12	17	15	12	7	12	2	23	22	12.20	12
Wins by Waza-ari %	9	17	9	16	18	10	11	0	12.48	4	20	8	21	14	21	14	4	14.91	13
Wins by Yuko %	25	19	13	21	9	18	11	7	16.22	30	27	19	5	25	29	11	13	20.05	18
Wins by 3 Shido for opponent %	16	6	6	4	3	4	13	4	6.77	0	2	2	2	1	2	9	4	2.71	5
Wins by direct Hansoku-make %	2	0	0	2	0	1	0	0	0	4	0	0	0	0	0	0	0	0	1
Double HSK %	0	0	0	0	0	0	0	0	0	0	0	0	0	0	0	0	0	0	0
All positive Scores (Yuko + Waza-ari + direct Ippon)	89	121	204	154	137	137	74	46	962	36	68	73	94	126	91	81	39	608	1570
Average Scores per contests	17	6	6	7	3	6	13	4	1.71	4	2	2	2	1	2	9	4	1.65	6
Contests with score %	83	94	94	95	100	96	93	100	94.12	96	98	98	98	99	98	95	100	97.83	96
All penalties (Shido + HSK)	106	98	115	117	85	68	47	27	663	11	35	66	49	57	77	52	22	369	1032
Average penalty per contest	1.66	1.27	1.06	1.29	1.1	0.94	1.04	1	1.18	0.48	0.85	1.38	0.88	0.79	1.24	1.18	0.96	1	1.11
Contests with only penalty %	17	6	6	5	0	4	7	0	5.88	4	2	2	2	1	2	5	0	2.17	4
Number of Osae-komi (Absolute)	9	16	32	12	42	21	14	15	161	15	14	26	18	50	17	20	11	171	332
Osae-komi no score %	44.44	43.75	46.88	25.00	45.24	38.10	50.0	33.33	42.24	6.67	35.71	50.0	44.44	52.00	47.06	35.00	45.45	42.69	42.47
Osae-komi Yuko %	0	6.25	3.12	8.33	4.76	9.52	0	26.67	1.96	20.0	7.14	3.85	11.11	0	11.76	5.00	9.09	2.98	6.63
Osae-komi Waza-ari %	22.22	18.75	25.00	25.00	23.81	38.10	35.71	20.0	7.49	40.0	35.71	19.23	16.67	22.00	23.53	45.00	18.18	12.20	26.20
Osae-komi Ippon %	33.33	31.25	25.00	41.67	26.19	14.29	14.29	20.0	7.13	33.33	21.43	26.92	27.78	26.00	17.65	15.00	27.27	11.38	24.70
Direct Hansoku-make	1	0	0	2	0	1	0	0	4	1	0	0	0	0	0	0	0	1	5
Fusen-gachi	1	1	1	1	1	1	1	1	8	0	0	1	0	2	1	0	0	4	12
Doctor call	0	0	0	0	0	0	0	0	0	0	0	0	0	0	0	0	0	0	0
Golden Score %	30	14	15	13	13	15	9	15	15.51	22	15	15	11	6	23	9	9	13.01	15
Golden Score Duration AVG	105.47	150.36	97.25	153.75	129	103.64	59.5	97.75	116.30	33	75	52.14	88.5	29.75	101	180	33	79.79	103.32
Golden Score Duration MAX	357	330	398	574	343	180	85	220	574	58	185	120	142	59	261	269	35	269	574



Nations Overview

Berlin Millennium Team Cadet European Cup 2026, 25-26 Apr 2026

Nations

Overview

			-50	-55	-60	-66	-73	-81	-90	+90	M	-40	-44	-48	-52	-57	-63	-70	+70	W	Total	Ref	D
1.		AUT Austria	2	1	4	1	2	2	3		15		2	2	2	3	4	3		16	31	2	7
2.		AZE Azerbaijan	1	3	2	3	3	4	2	2	20	2	3	2	2	4	3	2	1	19	39	2	7
3.		BEL Belgium	4	1	2	2	1	1	2		13		2	2	1	2	1	1		9	22	0	5
4.		BUL Bulgaria	1	2	1	5	3	2	1		15					1	1		1	3	18	0	3
5.		CRO Croatia		1	2	3	2	2	1		11			1	1	1		2		5	16	0	4
6.		CYP Cyprus		1		1					2									0	2	0	1
7.		CZE Czechia	1	1	3	3	1	2	2	2	15	1				1	1	2		5	20	2	5
8.		DEN Denmark		1		1	1	1	1		5			1					1	2	7	0	1
9.		ESP Spain	4	3	6	8	3		2	1	27	1	2	3	5	4	3	1	2	21	48	0	16
10.		EST Estonia	1		2	2	4	7	2	1	19			1	1		1			3	22	0	9
11.		FIN Finland		2	1						3				1	2				3	6	0	1
12.		FRA France	2	1	2	2	2	2	2	3	16	2	2	2	2	3	2	2	2	17	33	0	6
13.		FRO Faroe Islands					1				1									0	1	0	1
14.		GBR Great Britain	1	5	3	2	3	2			16		1	2	3	4	1	2		13	29	2	6
15.		GEO Georgia	1	1	1	1					4									0	4	0	1
16.		GER Germany	9	13	17	16	13	15	5	3	91	2	2	5	12	11	8	7	4	51	142	10	61
17.		GRE Greece			1	1		1			3						1	1		2	5	1	1
18.		ISR Israel	6	9	13	5	7	4	1	1	46	1	2	3	3	5	2	1		17	63	0	14
19.		ITA Italy		3	2	2	2	1	1		11		2	1	1	2	3		1	10	21	0	12
20.		KGZ Kyrgyzstan	2	3	2	2	1	2	1	1	14		2			1	2			5	19	0	5
21.		LAT Latvia	1	2	2		1	1	1	1	9						1			1	10	0	4
22.		LTU Lithuania	2	1	2	3	1	1	2		12			1		2	1			4	16	0	3
23.		MDA Republic of Moldova	2	1	1						4				2	1		1		4	8	0	3
24.		MNE Montenegro			1		1	1			3									0	3	0	2
25.		NED Netherlands	2	3	2	1	2	2	2	2	16	2	2	1	1	2	2	2	3	15	31	1	19
26.		NOR Norway				2	1				3							1		1	4	0	2
27.		POR Portugal	2	2	2	3	1	1			11			3		2	3	1		9	20	2	8
28.		ROU Romania	2	1	5	1	3	3	1	1	17	2	3	1	1	1	2	1		11	28	1	7
29.		SRB Serbia	1			2					3			1	1					2	5	0	2
30.		SUI Switzerland			2	2	1		1		6				1		1			2	8	0	1
31.		SVK Slovakia									0		1			1				2	2	0	2
32.		SWE Sweden			4		1	1		1	7		1	3	4	1	1			10	17	0	2
33.		TUR Türkiye	2		2	1					5	2	2	1	1	2	3	2	1	14	19	2	5
34.		UKR Ukraine									0						1			1	1	0	0
35.		UZB Uzbekistan	1	2	2	1	1	1	1	1	10	1	2	1		2		1		7	17	0	6
			50	63	89	76	62	59	34	20	453	16	31	37	45	58	48	33	16	284	737	25	232

Total: 737 competitors from 35 countries and 2 continents



Berlin Millennium Team Cadet European Cup 2026

Germany, Berlin, 25-26 Apr 2026

-50 kg

Men (50)

POOL A

ISR	GAT MUALEM Hillel	1	GAT MUALEM H. (ISR)	33	GAT MUALEM H. (ISR)
ROU	FOTA Mina Robin	2	CABEZAS SEVILLA V. (ESP)	000 s0 / 100 s1 [03:36]	100 s1 / 010 s2 [03:47]
ESP	CABEZAS SEVILLA Victor	3	GAFFARLI A. (GER)	100 s1 / 000 s3 [05:33]	GAFFARLI A. (GER)
GER	GAFFARLI Ali	4	ZUBETS R. (EST)	100 s0 / 000 s3 [02:59]	GAFFARLI A. (GER)
BEL	GEUNS Gust	5	SEGUIN L. (GBR)	000 s0 / 001 s0 [04:00]	LAHRIFI M. (FRA)
EST	ZUBETS Rodion	6	ROLNICKI A. (ISR)	100 s0 / 000 s0 [02:57]	LAHRIFI M. (FRA)
GBR	SEGUIN Louie	7	MUNTEANU R. (MDA)	000 s0 / 111 s0 [01:21]	001 s2 / 002 s0 [04:56]
ISR	ROLNICKI Alon	8	SPURK Paul	000 s2 / 001 s0 [04:00]	000 s2 / 100 s0 [02:06]
SRB	MATANOVIC Luka		LAHRIFI Moulay-Mountasir		
NED	POELSTRA Ferron				
MDA	MUNTEANU Ruslan				
GER	SPURK Paul				
FRA	LAHRIFI Moulay-Mountasir				

POOL B

TUR	DOGRU Suleyman	9	DOGRU S. (TUR)	37	DOGRU S. (TUR)
BUL	ILCHEV Martin	10	ILCHEV M. (BUL)	110 s0 / 010 s2 [04:58]	101 s0 / 000 s0 [01:00]
GER	PATZ John-Lukas	11	LOPEZ PEREIRA H. (ESP)	000 s0 / 101 s0 [01:00]	DOGRU S. (TUR)
LTU	JASAITIS Rokas	12	KOSLAEV M. (AUT)	102 s0 / 000 s0 [03:18]	101 s0 / 000 s1 [01:22]
ESP	LOPEZ PEREIRA Hugo	13	ABDUVAKHOBOV M. (UZB)	020 s0 / 000 s1 [02:00]	LOPEZ PEREIRA H. (ESP)
AUT	KOSLAEV Muhammad	14	PALMAERTS J. (BEL)	100 s0 / 000 s2 [04:44]	ABDUVAKHOBOV M. (UZB)
UZB	ABDUVAKHOBOV Mamurjon	15	MAST Tom	000 s0 / 100 s0 [04:59]	ABDUVAKHOBOV M. (UZB)
BEL	PALMAERTS Jolan	16	MAMATOV A. (KGZ)	010 s1 / 000 s1 [04:00]	ABDUVAKHOBOV M. (UZB)
GER	KRETZSCHMAR Dwayne				
ISR	MAST Tom				
POR	ALVES Andre Henrique				
POR	ALVES Andre Henrique				
KGZ	MAMATOV Ariet				

POOL C

NED	HEIMANS Klaas	17	HEIMANS K. (NED)	41	DOBROVOLSIS M. (LTU)
LAT	TANASI Sando	18	DOBROVOLSIS M. (LTU)	000 s3 / 100 s1 [09:17]	000 s2 / 001 s2 [09:57]
LTU	DOBROVOLSIS Mantas	19	MOUSSAID M. (BEL)	000 s0 / 100 s0 [00:00]	DOBROVOLSIS M. (LTU)
ISR	NAKASH Itai	20	DAVYDOV H. (GER)	101 s1 / 000 s0 [03:00]	100 s2 / 000 s3 [05:18]
BEL	MOUSSAID Mehdi	21	YAGUE LANCHA R. (ESP)	000 s1 / 001 s1 [04:00]	DOBROVOLSIS M. (LTU)
GER	DAVYDOV Henry	22	RAHMANI N. (ISR)	000 s2 / 010 s1 [06:10]	100 s1 / 000 s3 [04:54]
ESP	YAGUE LANCHA Ruben	23	BERNUZ H. (FRA)	011 s1 / 001 s0 [04:00]	MAMETYEY R. (GER)
CZE	SOUKUP Matyas	24	MAMETYEY R. (GER)	010 s1 / 011 s0 [04:00]	000 s0 / 020 s0 [03:52]
ISR	RAHMANI Noam				
ISR	RAHMANI Noam				
FRA	BERNUZ Hugo				
AUT	MURTAZALIEV Samad				
KGZ	ISHENALIEV Syimyk				
GER	MAMETYEY Roman				

POOL D

GER	KELLER Aaron Joshua	25	KELLER A. (GER)	45	KELLER A. (GER)
MDA	MINZAT Marius	26	ASIK T. (TUR)	000 s0 / 001 s2 [06:32]	002 s1 / 001 s1 [04:00]
TUR	ASIK Taha Baran	27	LEVINGER E. (ISR)	002 s1 / 000 s0 [04:00]	KELLER A. (GER)
ISR	LEVINGER Ehud	28	BLASCO PEREZ I. (ESP)	000 s0 / 100 s0 [01:03]	100 s1 / 000 s1 [01:25]
BEL	DEWULF Lorn	29	STOLAKIS M. (GER)	47	STOLAKIS M. (GER)
ESP	BLASCO PEREZ Imanol	30	TUDOR A. (ROU)	000 s1 / 101 s2 [04:00]	AGHAYEV N. (AZE)
GER	STOLAKIS Mariano	31	AGHAYEV N. (AZE)	000 s1 / 001 s1 [04:00]	AGHAYEV N. (AZE)
POR	QUINTINO Armando	32	SCHMIDT C. (GER)	100 s0 / 000 s0 [00:45]	AGHAYEV N. (AZE)
ROU	TUDOR Alin				
GEO	MAISURADZE Mate				
AZE	AGHAYEV Nihad				
GER	SCHMIDT Constantin Matthias				

REPECHAGE

GER	SPURK P. (GER)	61	MUNTEANU R. (MDA)	000 s0 / 100 s0 [00:21]	ROLNICKI A. (ISR)
MDA	MUNTEANU R. (MDA)	62	PALMAERTS J. (BEL)	001 s1 / 010 s0 [04:00]	GAFFARLI A. (GER)
BEL	PALMAERTS J. (BEL)	63	ALVES A. (POR)	100 s0 / 000 s0 [01:48]	ROLNICKI A. (ISR)
LAT	TANASI S. (LAT)	64	HEIMANS K. (NED)	100 s1 / 000 s3 [04:45]	001 s0 / 000 s1 [04:51]
NED	HEIMANS K. (NED)	65	MOUSSAID M. (BEL)	020 s0 / 000 s1 [02:37]	DOGRU S. (TUR)
GEO	MAISURADZE M. (GEO)	66	STOLAKIS M. (GER)	001 s0 / 010 s2 [04:00]	000 s0 / 011 s0 [04:00]
GER	SCHMIDT C. (GER)	67	KELLER A. (GER)	000 s3 / 100 s2 [06:20]	DOGRU S. (TUR)
ISR	ROLNICKI A. (ISR)	68	HEIMANS K. (NED)	100 s1 / 000 s3 [04:45]	HEIMANS K. (NED)
BEL	PALMAERTS J. (BEL)	69	MAMETYEY R. (GER)	020 s0 / 000 s1 [02:37]	HEIMANS K. (NED)
POR	ALVES A. (POR)	70	STOLAKIS M. (GER)	001 s0 / 010 s2 [04:00]	100 s0 / 000 s1 [03:31]
NED	HEIMANS K. (NED)	71	KELLER A. (GER)	000 s3 / 100 s2 [06:20]	LAHRIFI M. (FRA)
GEO	MAISURADZE M. (GEO)	72	HEIMANS K. (NED)	100 s1 / 000 s3 [04:45]	000 s3 / 100 s1 [03:42]
GER	SCHMIDT C. (GER)	73	LAHRIFI M. (FRA)	000 s2 / 001 s2 [07:36]	000 s3 / 100 s1 [03:42]
ISR	ROLNICKI A. (ISR)	74	AGHAYEV N. (AZE)	000 s0 / 020 s0 [01:00]	
BEL	PALMAERTS J. (BEL)	75	AGHAYEV N. (AZE)	010 s2 / 011 s1 [04:00]	
POR	ALVES A. (POR)	76	AGHAYEV N. (AZE)	000 s3 / 100 s0 [05:23]	
NED	HEIMANS K. (NED)	77	AGHAYEV N. (AZE)	000 s0 / 100 s0 [00:33]	
GEO	MAISURADZE M. (GEO)	78	AGHAYEV N. (AZE)	000 s0 / 100 s0 [00:33]	
GER	SCHMIDT C. (GER)	79	AGHAYEV N. (AZE)	000 s0 / 100 s0 [00:33]	

FINAL RESULTS

- AGHAYEV Nihad
- ABDUVAKHOBOV Mamurjon
- DOGRU Suleyman
- LAHRIFI Moulay-Mountasir
- DOBROVOLSIS Mantas
- HEIMANS Klaas
- ROLNICKI Alon
- KELLER Aaron Joshua





Berlin Millennium Team Cadet European Cup 2026

Germany, Berlin, 25-26 Apr 2026

-55 kg

Men (63)

POOL A

1	UYAR Celil (NED)	UYAR C. (NED)
2	LEUPOLD Ansgar Thorben (GER)	BEN LULU J. (ISR)
3	BEN LULU Jonathan (ISR)	KREMER A. (GER)
4	KREMER Arthur (GER)	DOCHERTY Jack (GBR)
5	DOCHERTY Jack (GBR)	DE LAURENTIS M. (ITA)
6	BIOSCA GARCIA Renat (ESP)	DE LAURENTIS M. (ITA)
7	DE LAURENTIS Mattia (ITA)	PICKEL Daniel (ISR)
8	PICKEL Daniel (ISR)	SEFSAF Hamza (BEL)
9	SEFSAF Hamza (BEL)	KOKKONEN Valtteri (FIN)
10	KOKKONEN Valtteri (FIN)	DREWS Fabian (GER)
11	DREWS Fabian (GER)	RACKAUSKAS Ignas (LTU)
12	RACKAUSKAS Ignas (LTU)	NOETZEL Linus (GER)
13	NOETZEL Linus (GER)	SINAGINS Nils (LAT)
14	SINAGINS Nils (LAT)	VUSHEV Aleksandar (BUL)
15	VUSHEV Aleksandar (BUL)	

POOL B

9	KHALILLI Rza (AZE)	ISMAILOV B. (KGZ)
10	ISMAILOV Baiel (KGZ)	TANSINGCO Gabryl (GER)
11	TANSINGCO Gabryl (GER)	AMARAL Joao (POR)
12	AMARAL Joao (POR)	BROWN Ishmael (GBR)
13	BROWN Ishmael (GBR)	FUCHS Yuval (ISR)
14	FUCHS Yuval (ISR)	GARVE Sou (GER)
15	GARVE Sou (GER)	LEGER VILLA Lucien (FRA)
16	LEGER VILLA Lucien (FRA)	TALIBOV Ibrahim (AZE)
17	TALIBOV Ibrahim (AZE)	PANDAY Diego (NED)
18	PANDAY Diego (NED)	KURBANOV Djamil (AUT)
19	KURBANOV Djamil (AUT)	PETROSINO E. (ITA)
20	PETROSINO E. (ITA)	GAFFARLI Al-Hasan (GER)
21	GAFFARLI Al-Hasan (GER)	OLARASU Constantin (MDA)
22	OLARASU Constantin (MDA)	ROMI Guy (ISR)
23	ROMI Guy (ISR)	LEMOS RODRIGUEZ Omar (ESP)
24	LEMOS RODRIGUEZ Omar (ESP)	

POOL C

17	SHREBERK Guy (ISR)	SHREBERK G. (ISR)
18	EVERS Fynn (GER)	KHUDIYEV Farid (AZE)
19	KHUDIYEV Farid (AZE)	ZIRAKASHVILI Merabi (GEO)
20	ZIRAKASHVILI Merabi (GEO)	BLACKSHAW Reece (GBR)
21	BLACKSHAW Reece (GBR)	BARAK Davor (GER)
22	BARAK Davor (GER)	HILARIO Rodrigo (POR)
23	HILARIO Rodrigo (POR)	KAMCHYBEKOV Yiman (KGZ)
24	KAMCHYBEKOV Yiman (KGZ)	SHVARTS Amit (ISR)
25	SHVARTS Amit (ISR)	VLAD Sorin (ROU)
26	VLAD Sorin (ROU)	VUSHEV Mihail (BUL)
27	VUSHEV Mihail (BUL)	LASICA Andrej (CRO)
28	LASICA Andrej (CRO)	TABACHNIK Liam (ISR)
29	TABACHNIK Liam (ISR)	DOUINE Matteo (ITA)
30	DOUINE Matteo (ITA)	MANSUR Xavio (NED)
31	MANSUR Xavio (NED)	PETROV Stephan (GER)
32	PETROV Stephan (GER)	

POOL D

25	YUSUPOV Bobur (UZB)	YUSUPOV B. (UZB)
26	SILEN Topi (FIN)	IEVINS M. (LAT)
27	BERMAN Shayan (ISR)	IEVINS Martins (LAT)
28	IEVINS Martins (LAT)	JAKL Marek (CZE)
29	JAKL Marek (CZE)	MUELLER Andrej (GER)
30	MUELLER Andrej (GER)	HUNTER Luke (GBR)
31	HUNTER Luke (GBR)	FELLOUKA Loizos (CYP)
32	FELLOUKA Loizos (CYP)	USMONOV Shokhjakhon (UZB)
33	USMONOV Shokhjakhon (UZB)	ASILBEKOV Ramis Stalbekovich (KGZ)
34	ASILBEKOV Ramis Stalbekovich (KGZ)	HARDT Constantin (GER)
35	HARDT Constantin (GER)	JOERGENSEN Romeo (DEN)
36	JOERGENSEN Romeo (DEN)	RHODES Lewis (GBR)
37	RHODES Lewis (GBR)	TARASOV Aleksander (ISR)
38	TARASOV Aleksander (ISR)	LLENA CARDIL Ivan (ESP)
39	LLENA CARDIL Ivan (ESP)	BAUER Eddie (GER)
40	BAUER Eddie (GER)	

REPECHAGE

61	BEN LULU J. (ISR)	BEN LULU J. (ISR)
62	PANDAY D. (NED)	PETROSINO E. (ITA)
63	PETROSINO E. (ITA)	ZIRAKASHVILI M. (GEO)
64	ZIRAKASHVILI M. (GEO)	SHREBERK G. (ISR)
65	SHREBERK G. (ISR)	SILEN T. (FIN)
66	SILEN T. (FIN)	IEVINS M. (LAT)
67	IEVINS M. (LAT)	JAKL M. (CZE)
68	JAKL M. (CZE)	ASILBEKOV R. (KGZ)
69	DE LAURENTIS M. (ITA)	PICKEL D. (ISR)
70	PICKEL D. (ISR)	PETROSINO E. (ITA)
71	PETROSINO E. (ITA)	SHREBERK G. (ISR)
72	SHREBERK G. (ISR)	ASILBEKOV R. (KGZ)
73	UYAR C. (NED)	TALIBOV I. (AZE)
74	TALIBOV I. (AZE)	KHUDIYEV F. (AZE)
75	KHUDIYEV F. (AZE)	YUSUPOV B. (UZB)
76	YUSUPOV B. (UZB)	SHREBERK G. (ISR)
77	SHREBERK G. (ISR)	UYAR C. (NED)
78	UYAR C. (NED)	

FINAL RESULTS

1. KHUDIYEV Farid (AZE)
2. TALIBOV Ibrahim (AZE)
3. YUSUPOV Bobur (UZB)
3. UYAR Celil (NED)
5. PETROSINO Errico (ITA)
5. SHREBERK Guy (ISR)
7. PICKEL Daniel (ISR)
7. ASILBEKOV Ramis Stalbekovich (KGZ)





Berlin Millennium Team Cadet European Cup 2026

Germany, Berlin, 25-26 Apr 2026

-60 kg

Men (89)

POOL A

	CORI Timeo	SUI	1	CORI T. (SUI)
	PUSEY Stanley	GBR	2	SCHREURS P. (NED)
	SCHREURS Pim	NED		001 s0 / 002 s0 [04:00]
	PLUHATYROV Roman	GER	3	DASKAL E. (ISR)
	DASKAL Eyal	ISR		000 s0 / 012 s0 [04:00]
	HRISTOV Emo	BUL	4	HRISTOV E. (BUL)
	ZYCHLINSKI Ide	ISR	5	ZYCHLINSKI I. (ISR)
	LAZORKINS Timofejs	LAT	6	LAZORKINS T. (LAT)
	MEZHIEV Rasul	GER	7	MEZHIEV R. (GER)
	KOLOSOV Kristo	EST		013 s0 / 010 s0 [04:00]
	BISTRICEANU Luca	ROU	8	BISTRICEANU L. (ROU)
	CARABOTTO Gabriele	ITA	9	CARABOTTO G. (ITA)
	BLAZHKO Oleksandr	AUT	10	BLAZHKO O. (AUT)
	USINASHVILI Andro	GEO	11	USINASHVILI A. (GEO)
	CABECANA Phil	GER		100 s0 / 000 s0 [05:17]
	FILISTOVICH Maksim	SWE	12	FILISTOVICH M. (SWE)
	BURLACU CACALETEANU Vlad Andreas	ESP	13	BURLACU CACALETEANU V. (ESP)
	PINTRIJEL David	ROU		100 s0 / 000 s0 [04:49]
	RAIDOS Aristotelis	GER	14	RAIDOS A. (GER)
	GOLUBOVSKIJ Liutauras	LTU	15	PAULA L. (POR)
	PAULA Lourenco	POR		000 s0 / 100 s0 [01:08]
	WINKLER Inbar	ISR	16	WINKLER I. (ISR)
				001 s0 / 100 s1 [03:29]

POOL B

	GUR Ramazan Aykut	TUR	17	GUR R. (TUR)
	ASGAROV Mehman	AZE	18	ASGAROV M. (AZE)
	LUTZ Georgiy	GER		100 s0 / 000 s3 [03:39]
	SAMARTZIDIS Sergios	AUT	19	SAMARTZIDIS S. (AUT)
	CAVALJI Serzhei	CZE		100 s0 / 000 s0 [00:31]
	HENSSENS Noah	BEL	20	HENSSENS N. (BEL)
	KASIS Noam	ISR	21	KASIS N. (ISR)
	DAMIAN Veaceslav	ROU		100 s0 / 000 s0 [00:50]
	GALIMZHANOV Kainazar	KGZ	22	GALIMZHANOV K. (KGZ)
	MONTES OLIVA Lucas	ESP	23	NICOLAS T. (FRA)
	NICOLAS Thibault	FRA		000 s0 / 101 s0 [02:01]
	SCHUBERT Moritz	GER	24	SCHUBERT M. (GER)
	KOSTOEV Adam	SWE	25	KOSTOEV A. (SWE)
	LOKK Dmitry	GER	26	SATTOROV A. (UZB)
	SATTOROV Abubakr	UZB		000 s2 / 020 s0 [03:04]
	LOWENSTERN Nadav	ISR	27	LOWENSTERN N. (ISR)
	HOFFMANN Linus	GER		100 s0 / 000 s0 [00:09]
	RICHARDSON Michael	GBR	28	RICHARDSON M. (GBR)
	SCHUMANN Janek Paul	GER	29	SLOBODIAN V. (FIN)
	SLOBODIAN Vladyslav	FIN		000 s0 / 101 s2 [03:37]
	MIGUNOV GOMEZ Maksim	ESP	30	MIGUNOV GOMEZ M. (ESP)
				000 s3 / 100 s1 [05:02]
	MARLAIS Oliver Vlaho	CRO	31	MARLAIS O. (CRO)
	GOLDSHMIDT Eli	ISR	32	GOLDSHMIDT E. (ISR)
				000 s1 / 100 s0 [01:28]

REPECHAGE

CABECANA P. (GER)	125	CABECANA P. (GER)	129	CARABOTTO G. (ITA)	133	CARABOTTO G. (ITA)
FILISTOVICH M. (SWE)		101 s0 / 000 s0 [02:00]		000 s1 / 010 s0 [04:00]		010 s1 / 000 s2 [08:27]
LOKK D. (GER)		CARABOTTO G. (ITA)		WINKLER I. (ISR)		CORI T. (SUI)
KOSTOEV A. (SWE)	126	KOSTOEV A. (SWE)	130	KOSTOEV A. (SWE)	134	GOLDSHMIDT E. (ISR)
OSTERBERG S. (SWE)		000 s0 / 101 s0 [02:06]		020 s0 / 000 s0 [00:38]		001 s2 / 011 s0 [04:14]
MILIC M. (MNE)	127	OSTERBERG S. (SWE)	131	GROSS I. (ISR)	135	CERVINSKIS B. (LAT)
GELBARD N. (ISR)		001 s1 / 000 s2 [04:00]		000 s1 / 110 s0 [02:18]		000 s0 / 101 s1 [02:44]
MIHUT S. (ROU)	128	GELBARD N. (ISR)	132	GROMYK D. (GER)	136	SANCES TURON M. (ESP)
		110 s0 / 000 s1 [01:59]		000 s0 / 101 s0 [00:49]		000 s0 / 100 s0 [00:29]
		GROMYK D. (GER)		SANCES TURON M. (ESP)		CHIARRONI CUTILLAS A. (ESP)
				100 s0 / 100 s0 [00:29]		101 s1 / 001 s1 [05:34]

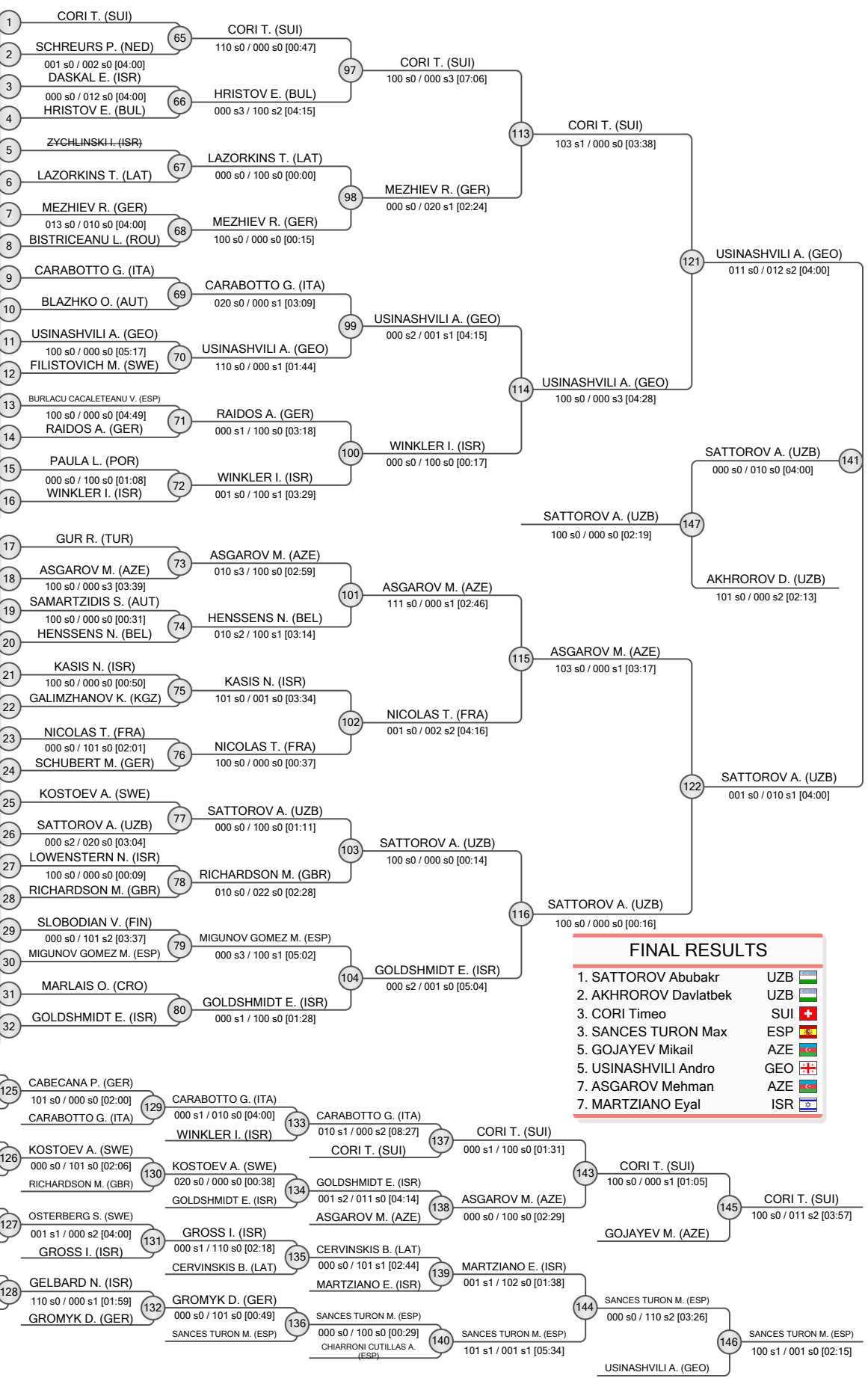

FINAL RESULTS

1.	SATTOROV Abubakr	UZB	
2.	AKHROV D. Davlatbek	UZB	
3.	CORI Timeo	SUI	
5.	GOJAYEV Mikail	AZE	
7.	USINASHVILI Andro	GEO	
7.	ASGAROV Mehman	AZE	
7.	MARTZIANO Eyal	ISR	





Berlin Millennium Team Cadet European Cup 2026

Germany, Berlin, 25-26 Apr 2026

-66 kg

Men (76)

POOL A

ISR	1	COHEN I. (ISR)	65	COHEN I. (ISR)
TUR	2	GUNUGUR Y. (TUR)	011 s1 / 000 s0 [04:00]	
GER		004 s2 / 000 s2 [04:00]		
ESP	3	LIZANA LEON M. (ESP)	66	LIZANA LEON M. (ESP)
BUL	4	SOTIROV G. (BUL)	012 s0 / 000 s2 [04:00]	
GER	5	TISCHLER E. (GER)	67	SOARES A. (POR)
CRO		102 s1 / 000 s1 [03:48]		
POR	6	SOARES A. (POR)	000 s0 / 110 s0 [00:49]	
GRE	7	SOPILIDIS G. (GRE)	68	SOPILIDIS G. (GRE)
GBR	8	PETROSYAN P. (GBR)	001 s1 / 000 s1 [04:00]	
AZE	9	PIRIYEV S. (AZE)	69	PIRIYEV S. (AZE)
ESP		001 s1 / 000 s1 [04:20]		
GER	10	GOMEZ ANTONA J. (ESP)	70	GBINGBEHI N. (FRA)
NOR	11	AAMODT A. (NOR)	000 s2 / 001 s2 [13:34]	
FRA	12	GBINGBEHI N. (FRA)	001 s1 / 100 s0 [02:26]	
EST	13	KOIV S. (EST)	71	BREZINA D. (CZE)
CZE		000 s1 / 101 s0 [03:56]		
ISR	15	SHIDLANSIK I. (ISR)	72	KULSHA A. (GER)
GER	16	KULSHA A. (GER)	000 s1 / 001 s2 [04:51]	

POOL B

SUI	17	DOBRAUZ L. (SUI)	73	FREIRES MARISCAL R. (ESP)
ESP		000 s0 / 100 s1 [02:05]		
GER	19	VOLKOV G. (GER)	74	PARLATI M. (ITA)
AZE		102 s1 / 010 s0 [03:53]		
ITA	20	PARLATI M. (ITA)	000 s0 / 110 s0 [00:45]	
CRO	21	VELICAN N. (CRO)	75	BAIYER P. (GER)
SRB		011 s0 / 000 s1 [04:00]		
GER	22	BAIYER P. (GER)	001 s2 / 100 s1 [02:54]	
ISR	23	SHACHAM I. (ISR)	76	SHACHAM I. (ISR)
KGZ		011 s2 / 010 s1 [05:44]		
CZE	25	SVEC H. (CZE)	77	SVEC H. (CZE)
GER		100 s0 / 000 s0 [01:29]		
DEN	26	FRICK L. (GER)	78	PAREULIDZE K. (GEO)
GEO		100 s0 / 000 s0 [01:33]		
GEO	27	PAREULIDZE K. (GEO)	010 s1 / 001 s1 [04:00]	
LTU	28	CIMBOLAS T. (LTU)	79	MELIAN GARCIA C. (ESP)
ESP		000 s0 / 100 s0 [01:10]		
GER	29	MELIAN GARCIA C. (ESP)	80	APOSTOLOV M. (BUL)
GER		100 s2 / 000 s3 [05:59]		
BEL	31	EMMERS T. (BEL)		
BUL	32	APOSTOLOV M. (BUL)		

REPECHAGE

125	GUNUGUR Y. (TUR)	129	GUNUGUR Y. (TUR)	133	GUNUGUR Y. (TUR)	137	GBINGBEHI N. (FRA)					
			101 s0 / 001 s0 [02:40]		010 s0 / 000 s0 [04:00]		000 s0 / 001 s0 [04:36]					
		126	FRICK L. (GER)	130	PARLATI M. (ITA)							
					010 s0 / 111 s2 [03:44]							
			127	ATAMANIUK R. (GER)	131	ATAMANIUK R. (GER)	135	ATAMANIUK R. (GER)				
					001 s1 / 000 s0 [05:25]		001 s1 / 000 s1 [04:00]					
					128	POLO LAGUNA M. (ESP)	132	WIENS D. (GER)	136	WIENS D. (GER)	140	KARIMOV A. (UZB)
												010 s1 / 110 s0 [02:20]
												000 s3 / 100 s1 [11:05]
												001 s1 / 000 s0 [04:00]

FINAL RESULTS	
1.	COHEN Itamar ISR
2.	TODOROV Vladimir BUL
3.	GARAYEV Ilkin AZE
3.	KARIMOV Akromjon UZB
5.	PARLATI Marco ITA
5.	SVEC Hynek CZE
7.	GBINGBEHI Nathan FRA
7.	ATAMANIUK Rostyslav GER





Berlin Millennium Team Cadet European Cup 2026

Germany, Berlin, 25-26 Apr 2026

-66 kg

Men (76)

POOL C

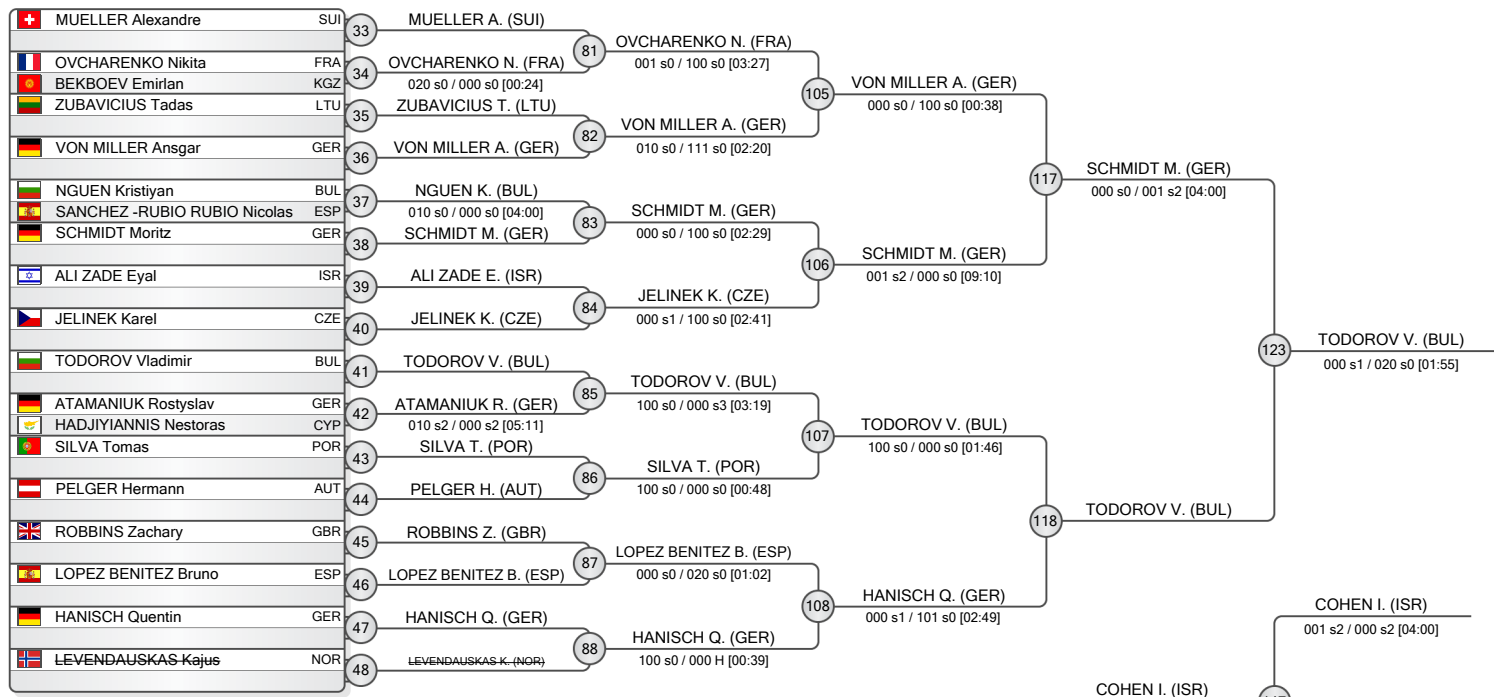

POOL D

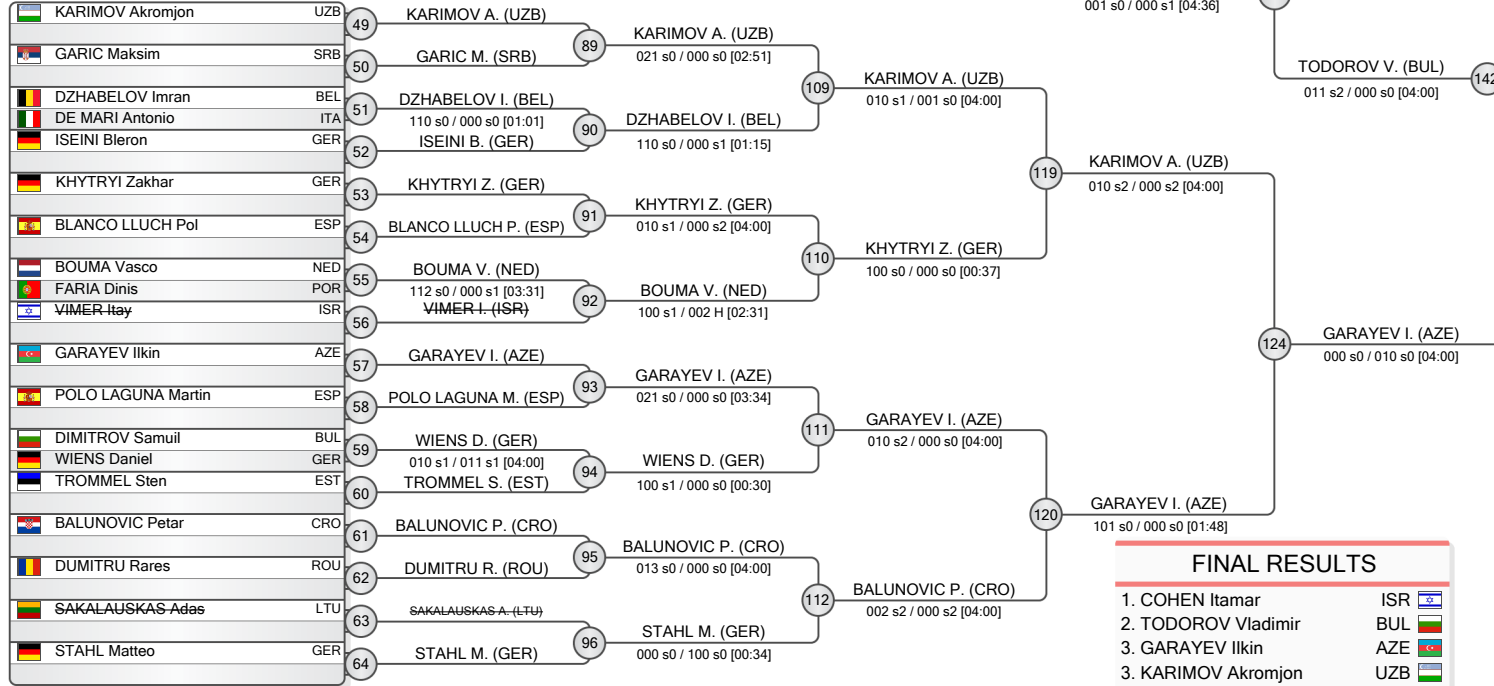

REPECHAGE

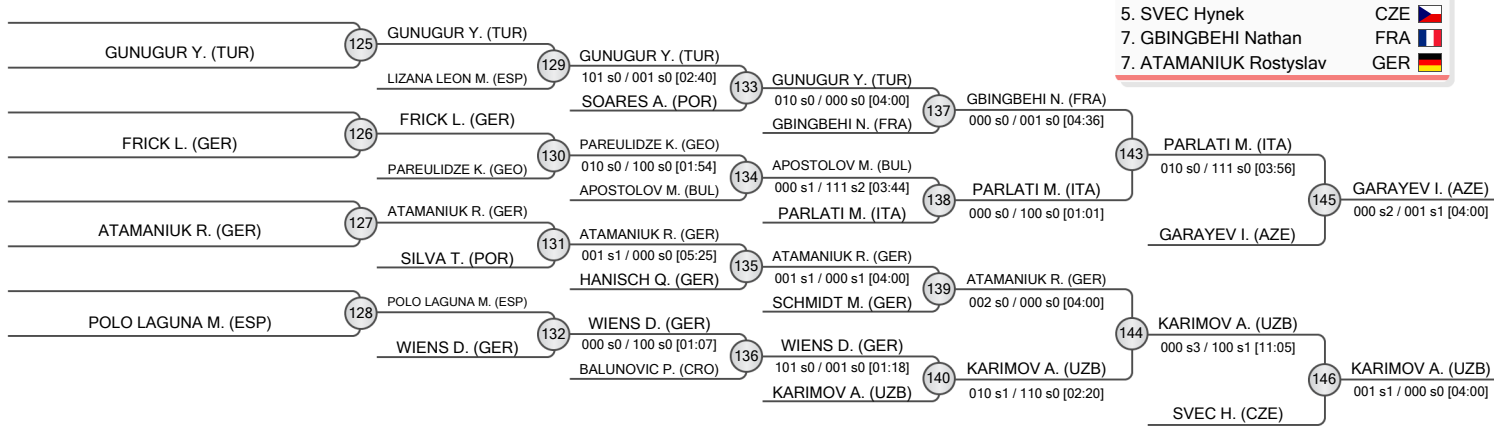

FINAL RESULTS	
1. COHEN Itamar	ISR
2. TODOROV Vladimir	BUL
3. GARAYEV Ilkin	AZE
5. KARIMOV Akromjon	UZB
5. PARLATI Marco	ITA
5. SVEC Hynek	CZE
7. GBINGBEHI Nathan	FRA
7. ATAMANIUK Rostyslav	GER





Berlin Millennium Team Cadet European Cup 2026

Germany, Berlin, 25-26 Apr 2026

-73 kg

Men (62)

POOL A

1	RUSNAK Adam (CZE)	1	RUSNAK A. (CZE)
2	KUTSON Kristjan (EST)	2	BOGAERT I. (BEL)
3	BOGAERT Ilkay (BEL)	3	MEYARA T. (ISR)
4	SCHERPING Maxim (GER)	4	REUTFORS V. (SWE)
5	MEYARA Tom (ISR)	5	MATUZNYI D. (GER)
6	REUTFORS Valter (SWE)	6	CECI E. (ITA)
7	KNEZEVIC Filip (MNE)	7	TOSCHPULOTOV D. (GER)
8	MATUZNYI Dmytro (GER)	8	MITOI S. (ROU)
9	HREN Adrian (CRO)	8	MARRERO TEJERA Yeremay (ESP)

POOL B

9	HRISTOFOROV Bruno (EST)	9	KILADZE L. (GER)
10	KILADZE Lazare (GER)	10	DOKOV K. (BUL)
11	DOKOV Kiril (BUL)	11	GILAD I. (ISR)
12	MARTON Medard (ROU)	12	HOVEN Max Theodor (NOR)
13	GILAD Itay (ISR)	13	NAZAR Y. (AZE)
14	SANTOS Samuel (POR)	14	KURTUMEROV Edem (GER)
15	PAUSKIC Silas (DEN)	15	KOKOEV KOKOEV Batraz (ESP)
16	HOVEN Max Theodor (NOR)	16	KURGHINYAN Misha (NED)
17	NAZAR Yusuf (AZE)	16	AGRONOV Idan (ISR)
18	KURTUMEROV Edem (GER)	16	EXMELIN Elyes (FRA)
19	KOKOEV KOKOEV Batraz (ESP)	16	MEDER-KURTOVIC Leon (AUT)
20	KURGHINYAN Misha (NED)	16	SCHUSTER Marek (GER)
21	AGRONOV Idan (ISR)	16	SCHUSTER Marek (GER)
22	EXMELIN Elyes (FRA)	16	SCHUSTER Marek (GER)
23	MEDER-KURTOVIC Leon (AUT)	16	SCHUSTER Marek (GER)
24	SCHUSTER Marek (GER)	16	SCHUSTER Marek (GER)

POOL C

17	NOGES Georg (EST)	17	NOGES G. (EST)
18	LENNON Cole (GBR)	18	SARZHANOV K. (KGZ)
19	SARZHANOV Kaisar (KGZ)	19	STOEGMANN S. (AUT)
20	STOEGMANN Stefan (AUT)	20	MOLIM Mayron (FRA)
21	MOLIM Mayron (FRA)	21	TSCHERHEIKO Mansur (GER)
22	TSCHERHEIKO Mansur (GER)	22	NISANOV Maxim (ISR)
23	NISANOV Maxim (ISR)	23	STINER Noam (ISR)
24	STINER Noam (ISR)	24	HANSCHMANN Juri (GER)
25	HANSCHMANN Juri (GER)	24	ZHELJAZKOV Dimitar (BUL)
26	ZHELJAZKOV Dimitar (BUL)	24	STEPINS Valters (LAT)
27	STEPINS Valters (LAT)	24	SLAVINSKAS Reinas (LTU)
28	SLAVINSKAS Reinas (LTU)	24	KUBITZA Maximilian (GER)
29	KUBITZA Maximilian (GER)	24	MAMMADOV Sadig (AZE)
30	MAMMADOV Sadig (AZE)	24	STARING Eros (NED)
31	STARING Eros (NED)	24	STARING Eros (NED)

POOL D

25	NIKOLCHEV Ivan (BUL)	25	NIKOLCHEV I. (BUL)
26	GOLOVKINS Denis (FRO)	26	ESSADE A. (SUI)
27	ESSADE Antoine (SUI)	27	POHLMANN Willi-Balduin (GER)
28	VULETIC Kevin (GER)	28	MCALEESE S. (GBR)
29	POHLMANN Willi-Balduin (GER)	29	SCHUERER H. (GER)
30	ALIKHANOV Amir (EST)	30	USMONOV B. (UZB)
31	MURESAN Erik (ROU)	31	USMONOV B. (UZB)
32	MCALEESE Sean (GBR)	32	RAHIMOV K. (AZE)
33	SCHUERER Hannes (GER)	32	SANUDO SAMPERIO D. (ESP)
34	BARBALATA Mario Florin (ITA)	32	MOLOMAN Sagi (ISR)
35	USMONOV Bekhruzbeq (UZB)	32	MOLOMAN Sagi (ISR)
36	VOJVODA Divo (CRO)	32	MOLOMAN Sagi (ISR)
37	STANJA Jonathan (GER)	32	MOLOMAN Sagi (ISR)
38	RAHIMOV Kanan (AZE)	32	MOLOMAN Sagi (ISR)
39	SANUDO SAMPERIO Dario (ESP)	32	MOLOMAN Sagi (ISR)
40	MOLOMAN Sagi (ISR)	32	MOLOMAN Sagi (ISR)

REPECHAGE

61	HREN A. (CRO)	61	CECI E. (ITA)
62	CECI E. (ITA)	62	HRISTOFOROV B. (EST)
63	HRISTOFOROV B. (EST)	63	STARING E. (NED)
64	DOKOV K. (BUL)	64	SLAVINSKAS R. (LTU)
65	STARING E. (NED)	65	VOJVODA D. (CRO)
66	SLAVINSKAS R. (LTU)	66	SCHUERER H. (GER)
67	VOJVODA D. (CRO)	67	RAHIMOV K. (AZE)
68	SCHUERER H. (GER)	68	ESSADE A. (SUI)
69	RAHIMOV K. (AZE)	69	ESSADE A. (SUI)
70	ESSADE A. (SUI)	70	ESSADE A. (SUI)
71	ESSADE A. (SUI)	71	ESSADE A. (SUI)
72	ESSADE A. (SUI)	72	ESSADE A. (SUI)

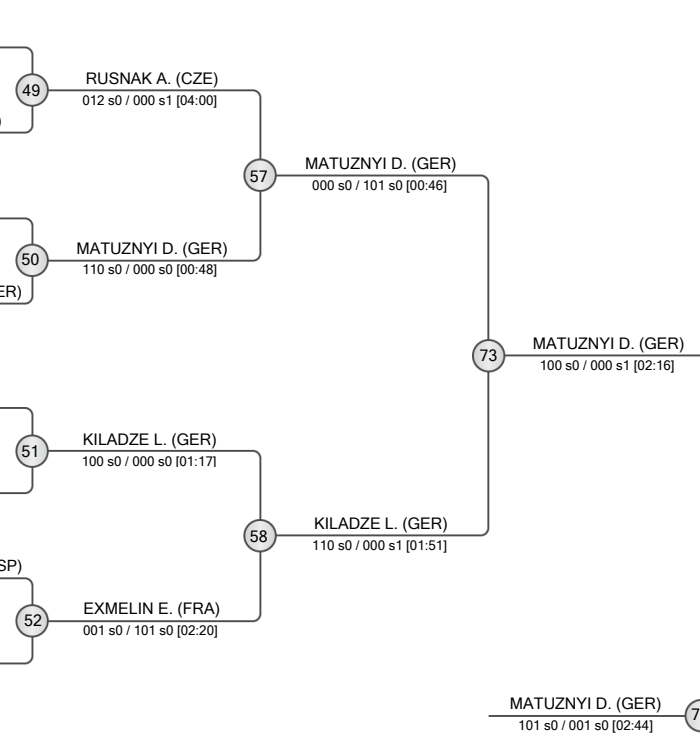

FINAL RESULTS		
1.	MATUZNYI Dmytro	GER
2.	MAMMADOV Sadig	AZE
3.	USMONOV Bekhruzbeq	UZB
3.	STARING Eros	NED
5.	HRISTOFOROV Bruno	EST
5.	KILADZE Lazare	GER
7.	CECI Emiliano	ITA
7.	SCHUERER Hannes	GER





Berlin Millennium Team Cadet European Cup 2026

Germany, Berlin, 25-26 Apr 2026

-81 kg

Men (59)

POOL A

	KIKAS Aleksei	EST
	SATOROVIC Emir	AUT
	WIESENBERGER Till Louis	GER
	HASANLI Aykhan	AZE
	VAN WOENSEL Ties	NED
	MADSEN Emil	DEN
	ADAMEC Maxmilian Tomas	CZE
	ROSENBERG Yoav	ISR
	NURTILEKOV Elgazy	KGZ
	BECK Flynt	GER
	PETRE David	ROU
	POPIVODA Vukan	MNE
	NUX Alexandre	FRA
	NURM August Martin	EST
	OSMANI Mensur	GER

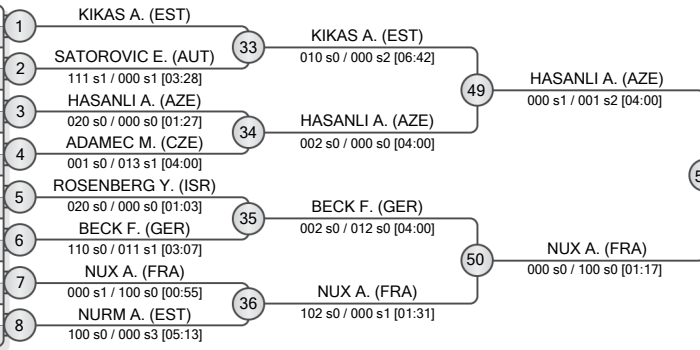

POOL B

	TOOMEL Joosep	EST
	MATTSSON Kalle	SWE
	KILADZE Giga	GER
	SILLAH Moise	GER
	KRMEK Roko Ivan	CRO
	PUGH Harvey	GBR
	SUPAKHUNOV David	LTU
	MAMMADOV Yagub	AZE
	KATSARSKI Teodor	BUL
	SCHWENKE Johann	GER
	GKOLIAS Efthymios	GRE
	HARCAVI Adam	ISR
	FENSKI Ole	GER
	SILLAR Richard	EST

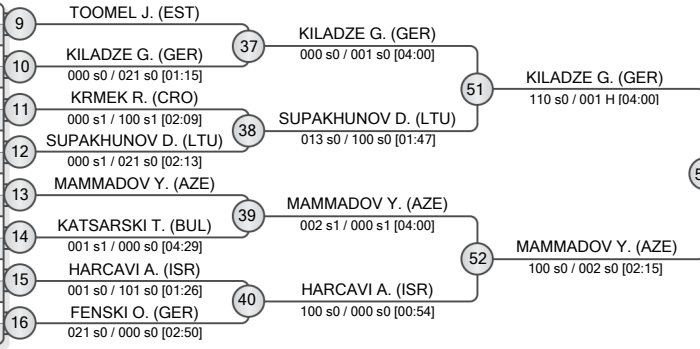

POOL C

	MEHDIYEV Amin	AZE
	MOOR Louis-Alexander	GER
	ERIKSON Mattias	EST
	ERLICH Roland	GER
	ISAKOV Baiel	KGZ
	IURCOVSCHI Daniel	FRA
	NAGY Akos	ROU
	HASANLI Polad	AZE
	AHRENS Jan Alexander	GER
	PODKUJKO Igors	LAT
	FARFELDER Samuel	AUT
	KOHVER Siim	EST
	DAVIDASHVILY Yakov	ISR
	FACHIRIDIS Stavros	GER
	SILVA Vicente	POR

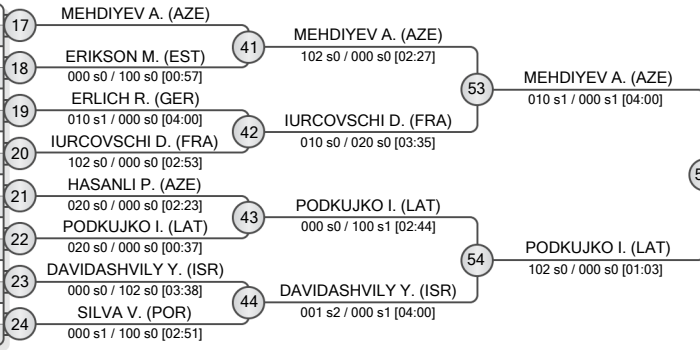

POOL D

	VALA Lukas	CZE
	VAN DER KROON Jan	NED
	UNTERBERG Lev	GER
	PONOMARENKO Ivan	GER
	MCGIVERN Aodhan	GBR
	MATHUES Sid	BEL
	CANEPARI Riccardo	ITA
	SUNNATOV Samandar	UZB
	SEIDELBERG Marten	EST
	DIMITROV Plamen	BUL
	MINICH Michail	GER
	KRZELJ Dante	CRO
	BEN SHITRIT Ehud	ISR
	KUNSZABO Matei	ROU
	KARAZELIDIS Pavlos	GER

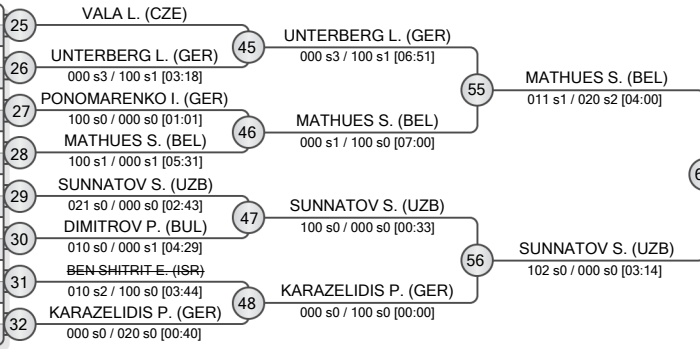

REPECHAGE

VAN WOENSEL T. (NED)	61	VAN WOENSEL T. (NED)	65	KIKAS A. (EST)	69	KIKAS A. (EST)	75	KILADZE G. (GER)	77	MEHDIYEV A. (AZE)
ADAMEC M. (CZE)	62	KIKAS A. (EST)	66	HARCAVI A. (ISR)	70	KILADZE G. (GER)	76	MATHUES S. (BEL)	78	MAMMADOV Y. (AZE)
KATSARSKI T. (BUL)	63	ERIKSON M. (EST)	67	ERIKSON M. (EST)	71	PODKUJKO I. (LAT)	77	MEHDIYEV A. (AZE)		
ERIKSON M. (EST)	64	DIMITROV P. (BUL)	68	KARAZELIDIS P. (GER)	72	MATHUES S. (BEL)	76	MAMMADOV Y. (AZE)		

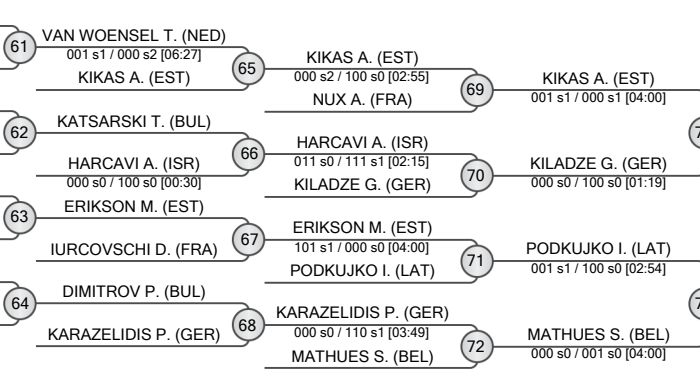

FINAL RESULTS		
1.	SUNNATOV Samandar	UZB
2.	HASANLI Aykhan	AZE
3.	MEHDIYEV Amin	AZE
4.	MAMMADOV Yagub	AZE
5.	KILADZE Giga	GER
5.	MATHUES Sid	BEL
7.	KIKAS Aleksei	EST
7.	PODKUJKO Igors	LAT





Berlin Millennium Team Cadet European Cup 2026

Germany, Berlin, 25-26 Apr 2026

-90 kg

Men (34)

POOL A

1	BABAICENKO T. (LTU)	33	BABAICENKO T. (LTU)
2	CLEDJO M. (BEL)		100 s0 / 000 s0 [00:27]
3	BEYELER G. (SUI)	34	KHABIR M. (FRA)
4	KHABIR M. (FRA)		000 s3 / 102 s0 [03:21]
5	YRYSOLOTOV M. (KGZ)	35	YRYSOLOTOV M. (KGZ)
6	NAUTA J. (NED)		001 s0 / 000 s0 [04:00]
7	GRAEBER J. (GER)	36	SEBELKA H. (CZE)
8	SEBELKA H. (CZE)		001 s3 / 100 s0 [03:49]

POOL B

9	MARKOVIC A. (CRO)	37	MARKOVIC A. (CRO)
10	TRUUVERK H. (EST)		100 s0 / 000 s0 [01:17]
11	SHNIDER O. (ISR)	38	SHNIDER O. (ISR)
12	WOERMANSEDER J. (AUT)		012 s0 / 000 s0 [04:00]
13	KOLOSOVS D. (LAT)	39	KOLOSOVS D. (LAT)
14	SEGUIN RENDAL I. (ESP)		020 s0 / 000 s2 [03:39]
15	ALIYEV N. (AZE)	40	ALIYEV N. (AZE)
16	AL-HASSANI S. (GER)		011 s1 / 000 s0 [04:00]

POOL C

17	ESHPULATOV J. (UZB)	41	ESHPULATOV J. (UZB)
18	LEETSAR K. (EST)		020 s0 / 000 s1 [02:56]
19	KONOPLYANYK N. (BEL)	42	KONOPLYANYK N. (BEL)
20	EMILOV B. (BUL)		100 s0 / 000 s0 [00:37]
21	SIGNORINI N. (ITA)	43	BOOMKAMP M. (NED)
22	BOOMKAMP M. (NED)		001 s1 / 020 s1 [02:41]
23	ALBRECHT A. (GER)	44	ALBRECHT A. (GER)
24	SIDLAUSKAS J. (LTU)		100 s0 / 000 s1 [03:22]

POOL D

25	SCHEIBER F. (AUT)	45	AKHUNDOV O. (AZE)
26	AKHUNDOV O. (AZE)		000 s0 / 001 s0 [04:16]
27	KISSK J. (GER)	46	KISSK J. (GER)
28	AMACIN M. (FRA)		101 s1 / 001 s3 [05:00]
29	GOLTZ J. (GER)	47	FERNANDEZ CALERO P. (ESP)
30	FERNANDEZ CALERO P. (ESP)		000 s0 / 100 s0 [00:00]
31	GARAGAU R. (ROU)	48	LAJCAK O. (CZE)
32	LAJCAK O. (CZE)		000 s2 / 021 s0 [00:00]

REPECHAGE

61	CLEDJO M. (BEL)	65	CLEDJO M. (BEL)	69	YRYSOLOTOV M. (KGZ)
			013 s0 / 000 s0 [04:00]		000 s0 / 020 s1 [01:30]
62	SEGUIN RENDAL I. (ESP)	66	ALIYEV N. (AZE)	70	ALIYEV N. (AZE)
			000 s0 / 020 s0 [01:10]		020 s0 / 000 s0 [00:54]
63	LEETSAR K. (EST)	67	LEETSAR K. (EST)	71	BOOMKAMP M. (NED)
			100 s2 / 000 s0 [02:33]		000 s0 / 011 s1 [04:00]
64	SCHEIBER F. (AUT)	68	SCHEIBER F. (AUT)	72	SCHEIBER F. (AUT)
			100 s0 / 000 s0 [00:57]		110 s1 / 000 s1 [02:06]

FINAL RESULTS		
1.	BABAICENKO Tajus	LTU
2.	AKHUNDOV Omar	AZE
3.	YRYSOLOTOV Mukhammedali	KGZ
3.	SCHEIBER Felix	AUT
5.	ESHPULATOV Jurabek	UZB
5.	KOLOSOVS Dmitrijs	LAT
7.	ALIYEV Nuraddin	AZE
7.	BOOMKAMP Marinus	NED





Berlin Millennium Team Cadet European Cup 2026

Germany, Berlin, 25-26 Apr 2026

+ 90 kg

Men (20)

POOL A

	SKODA Melichar	CZE
	KIASUMBUA Eilijah	FRA
	IKMAN Den	ISR
	TEGELAAR Jack	SWE
	THAMM Max Anton	GER

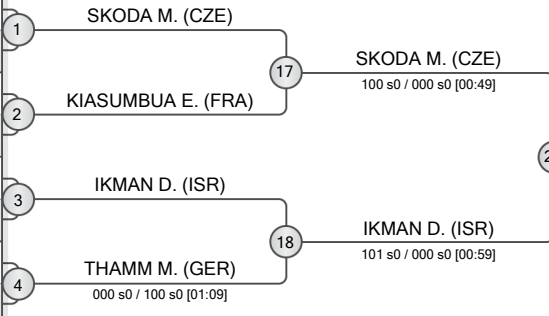

POOL B

	TOLIBAEV Ersultan	UZB
	SOM Samuel	FRA
	LOBATO PEREZ Aimar	ESP
	BADEA Petru	ROU
	BRUINING Joshua	NED

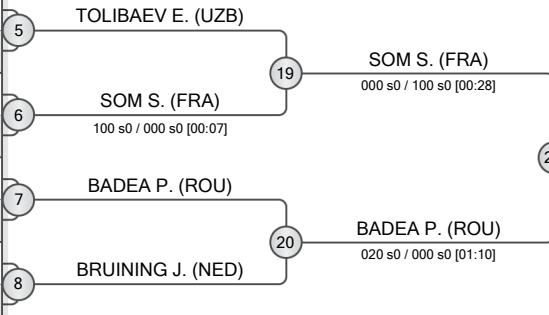

POOL C

	APSALONS Aleksandrs	LAT
	LODDES Romet	EST
	BRUNNER Jan	CZE
	RIETDIJK Keano	NED
	STETTINSKY Lucas	GER

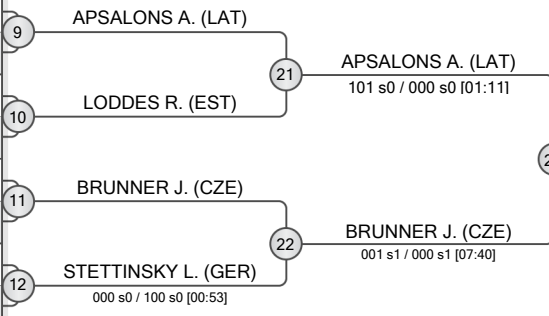

POOL D

	ALIYEV Tamerlan	AZE
	SAURA Nathan	FRA
	BRAUSEWETTER Maarten	GER
	KAZIMOV Ruslan	AZE
	BOLOTBEKOV Altynbek	KGZ

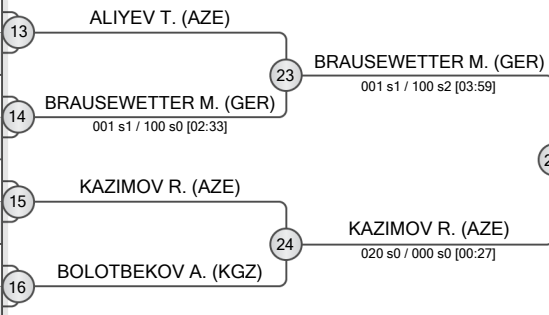

REPECHAGE

29	KIASUMBUA E. (FRA)
30	BRUINING J. (NED)
31	LODDES R. (EST)
32	BOLOTBEKOV A. (KGZ)

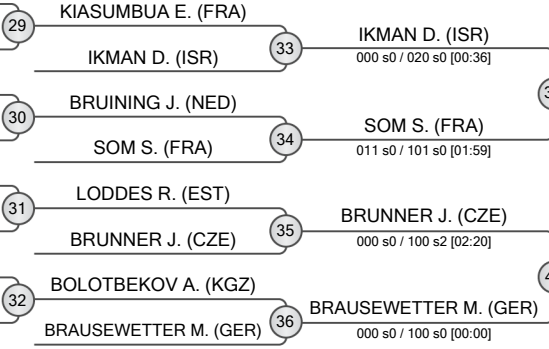

FINAL RESULTS	
1.	SKODA Melichar CZE
2.	APSALONS Aleksandrs LAT
3.	KAZIMOV Ruslan AZE
3.	BADEA Petru ROU
5.	SOM Samuel FRA
7.	BRUNNER Jan CZE
7.	IKMAN Den ISR
7.	BRAUSEWETTER Maarten GER





Berlin Millennium Team Cadet European Cup 2026

Germany, Berlin, 25-26 Apr 2026

-40 kg

Women (16)

POOL A

	GRACOVA Dominika	CZE
	BARRAY Jade	FRA
	BREM Nawaii	NED
	CRACIUN Ana Maria	ROU

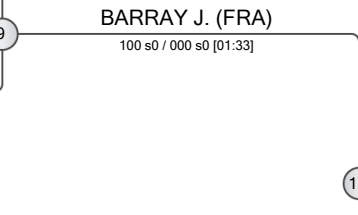
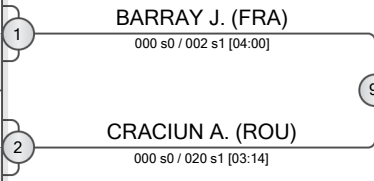

POOL B

	KARAKAZAN Elcin	TUR
	EMMERLING Greta	GER
	SIROJIDDINOVA Iroda	UZB
	GULIYEVA Zahra	AZE

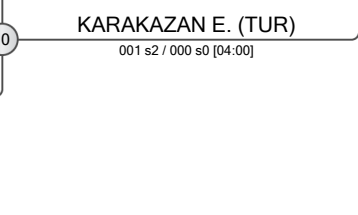
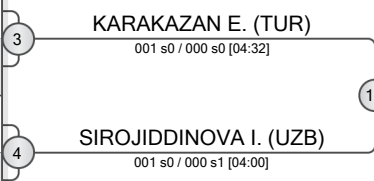

POOL C

	TOKMAK Havva Sena	TUR
	MOUSSATI Assia	FRA
	SALAMOVA Sunay	AZE
	PHAM Serra	NED

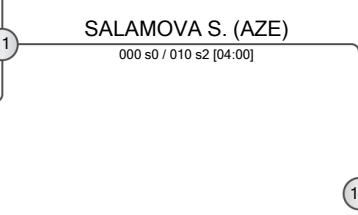
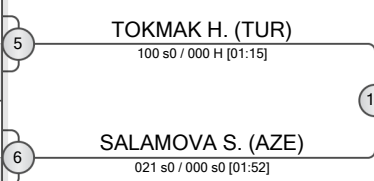

POOL D

	GAT MUALEM Avigayil	ISR
	BALANEAN Stefania	ROU
	COSTA CABANA Candela	ESP
	SCHEIDA Julia	GER

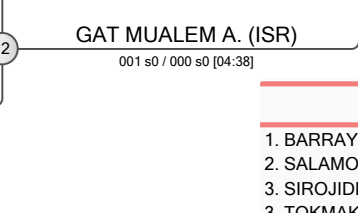
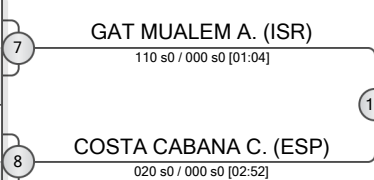

FINAL RESULTS		
1.	BARRAY Jade	FRA
2.	SALAMOVA Sunay	AZE
3.	SIROJIDDINOVA Iroda	UZB
3.	TOKMAK Havva Sena	TUR
5.	GAT MUALEM Avigayil	ISR
5.	KARAKAZAN Elcin	TUR
7.	GRACOVA Dominika	CZE
7.	COSTA CABANA Candela	ESP

REPECHAGE

GRACOVA D. (CZE)	13	GRACOVA D. (CZE)	100 s0 / 000 s0 [00:58]
CRACIUN A. (ROU)			
EMMERLING G. (GER)			
SIROJIDDINOVA I. (UZB)	14	SIROJIDDINOVA I. (UZB)	001 s0 / 020 s0 [01:15]
PHAM S. (NED)			
TOKMAK H. (TUR)	15	TOKMAK H. (TUR)	001 s0 / 020 s0 [01:15]
BALANEAN S. (ROU)			
COSTA CABANA C. (ESP)	16	COSTA CABANA C. (ESP)	001 s0 / 020 s0 [01:15]

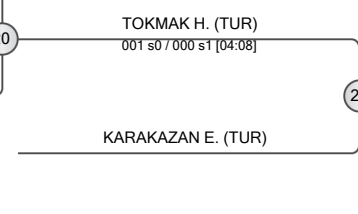
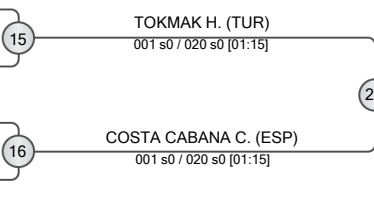
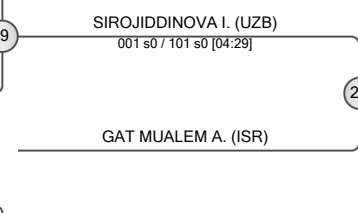
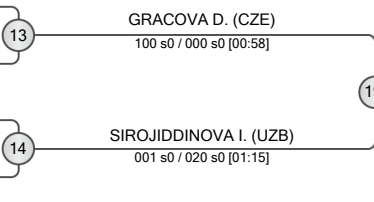



Berlin Millennium Team Cadet European Cup 2026

Germany, Berlin, 25-26 Apr 2026

-44 kg

Women (31)

POOL A

	LONGO Sofia	ITA
	MICHI Vivian Marie	GER
	HEYDARZADE Nigar	AZE
	DAVIS Katrina	GBR
	BROUNEN Fem	NED
	BIRINCI Hiranur	TUR
	SOFFER Lihi	ISR

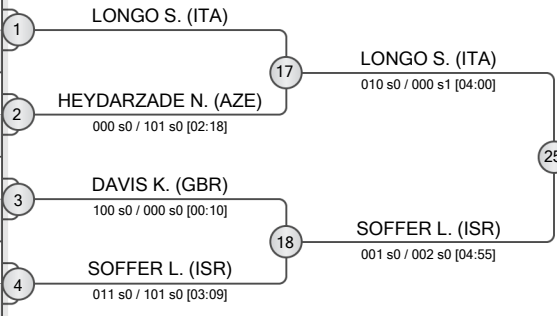

POOL B

	CONI Sara	ITA
	LUDVIG Amalia	ROU
	SOUBIELLE Maia	FRA
	SAMARDZHIDI Anna	AUT
	PEETERS Fenne	BEL
	KOLUCHEVA Alina	UZB
	MONZO PASCUAL Marta	ESP
	STEPANOVA Anastasiia	KGZ

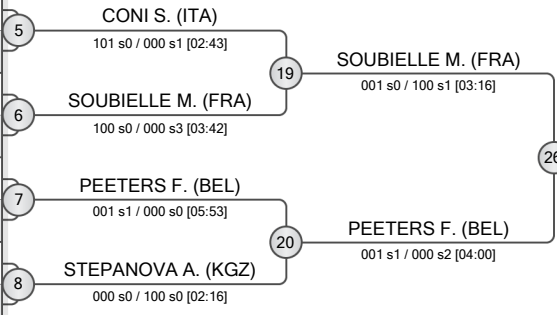

POOL C

	YILMAZTURK Yagmur	TUR
	ITSKOV Rivka	ISR
	HISSETTE Nell	BEL
	KILACKOVA Silvia	SVK
	ABDULLAYEVA Fatima	AZE
	MARIAN Daria	ROU
	BOLTABOEVA Dilafuz	UZB
	GRAVENSTIJN Tracey	NED

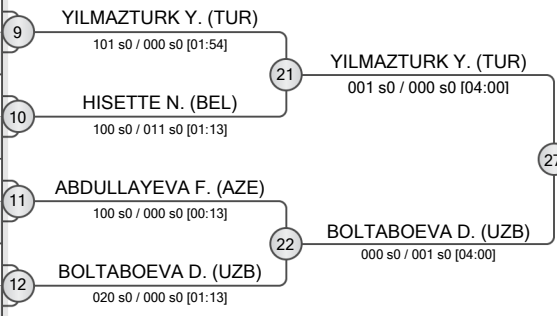

POOL D

	MANASBEKOVA Munira	KGZ
	VALVERDE DURAN Claudia	ESP
	SEVKHANLI Parvin	AZE
	SAMARDZHIDI Maria	AUT
	CIUMAS Bianca	ROU
	DEEB Leia	GER
	SURDEZ KAUL Zelie	FRA
	OSTERBERG Josephine	SWE

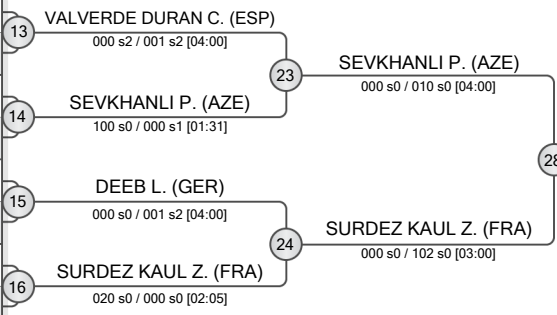

REPECHAGE

HEYDARZADE N. (AZE)	29	HEYDARZADE N. (AZE)
SAMARDZHIDI A. (AUT)	30	CONI S. (ITA)
CONI S. (ITA)	30	CONI S. (ITA)
ITSKOV R. (ISR)	31	HISSETTE N. (BEL)
HISSETTE N. (BEL)	31	HISSETTE N. (BEL)
SAMARDZHIDI M. (AUT)	32	VALVERDE DURAN C. (ESP)
VALVERDE DURAN C. (ESP)	32	VALVERDE DURAN C. (ESP)

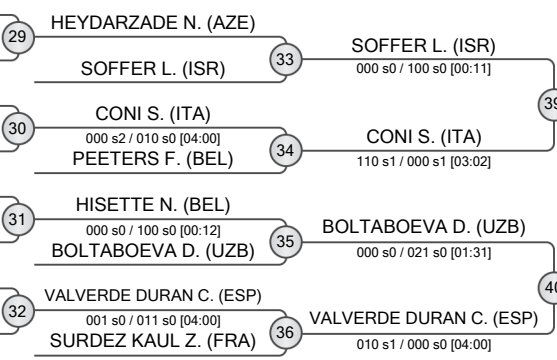

FINAL RESULTS	
1.	YILMAZTURK Yagmur
2.	LONGO Sofia
3.	SEVKHANLI Parvin
3.	BOLTABOEVA Dilafuz
5.	CONI Sara
7.	SOUBIELLE Maia
7.	SOFFER Lihi
7.	VALVERDE DURAN Claudia





Berlin Millennium Team Cadet European Cup 2026

Germany, Berlin, 25-26 Apr 2026

-48 kg

Women (37)

POOL A

	NOY Agam Sol	ISR
	NIJHUIS Jelena	NED
	ZEYNALOVA Sakina	AZE
	DOE Betsy	GBR
	CARVALHO Mariana	POR
	COSKUN Busra Ceylin	TUR
	KUNYIK Laura-Sophie	AUT
	MARTINEZ Navia	BEL
	BRUNETT Hanna	GER

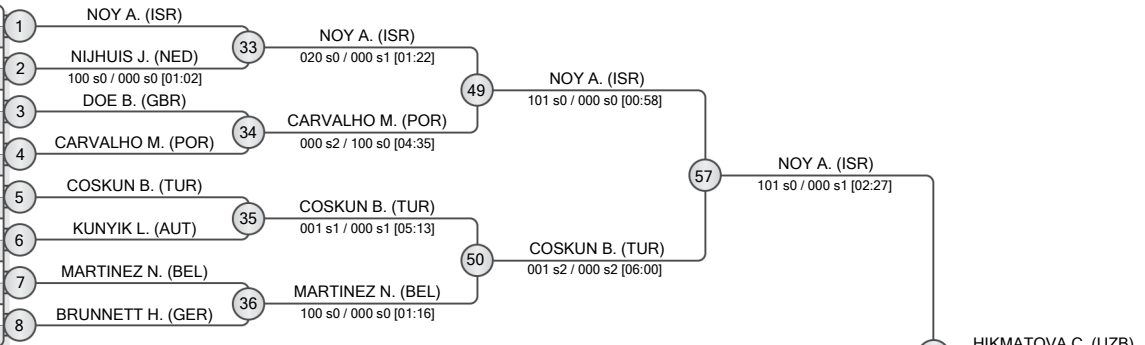

POOL B

	HIKMATOVA Charos	UZB
	KRATZER Helene	GER
	STEFANIE Mamitantly Oceana	FRA
	ROGOJINARU Adelina	ROU
	BIRGER Ella	ISR
	STORIONE Ludovica	ITA
	SOARES Maria	POR
	SANTIN MORENO Miriam	ESP
	WIJK Alma	SWE
	GORANOVIC Katarina	SRB

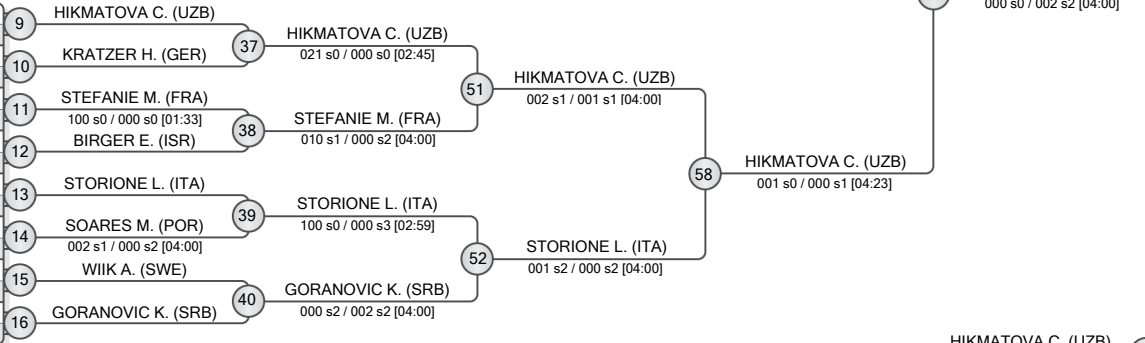

POOL C

	STARK Leeyam	ISR
	KOEPPEN Jane	GER
	WAHLSTROM Selma	SWE
	GRIGORYAN Viktoria	BEL
	BEERMANN Mia Marie	GER
	FONSBOEL Elena	DEN
	REMIGIO RUIZ Nadia	ESP
	BUCHANAN Alexis	GBR
	VALKAUSKAITE Vismante	LTU

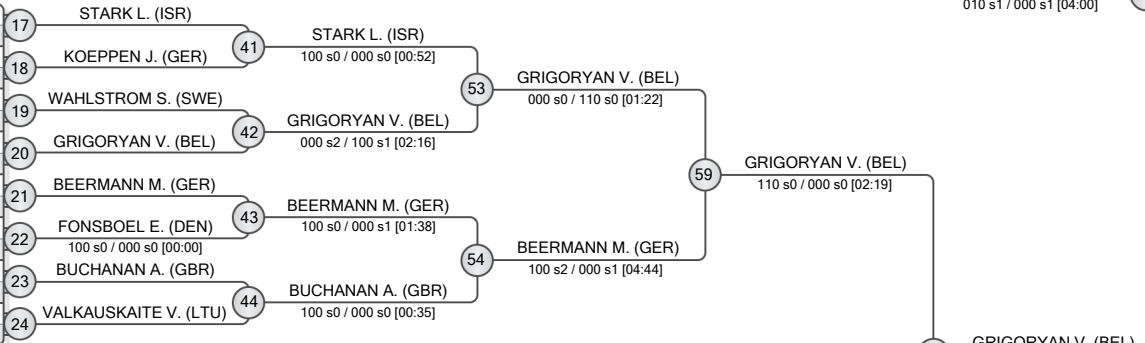

POOL D

	EYVAZLI Konul	AZE
	MANTAEVA Jasmina	AUT
	BELTRAN MARUENDA Ivet	ESP
	TIXIER Line	FRA
	FRANCO Carolina	POR
	AZARUMYAN Anna	EST
	FALDT Lova	SWE
	STEINBERG Michelle	GER
	KATUSIC Nika	CRO

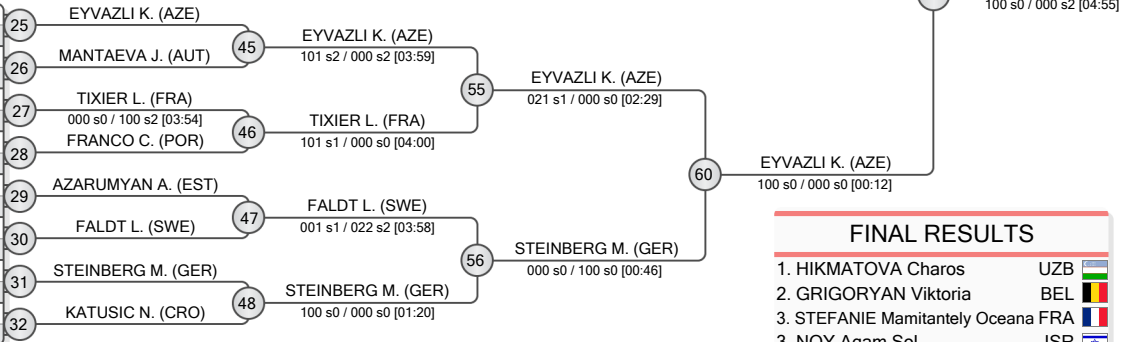

FINAL RESULTS		
1.	HIKMATOVA Charos	
2.	GRIGORYAN Viktoria	
3.	STEFANIE Mamitantly Oceana	
3.	NOY Agam Sol	
5.	EYVAZLI Konul	
5.	BEERMANN Mia Marie	
7.	NIJHUIS Jelena	
7.	MANTAEVA Jasmina	

REPECHAGE

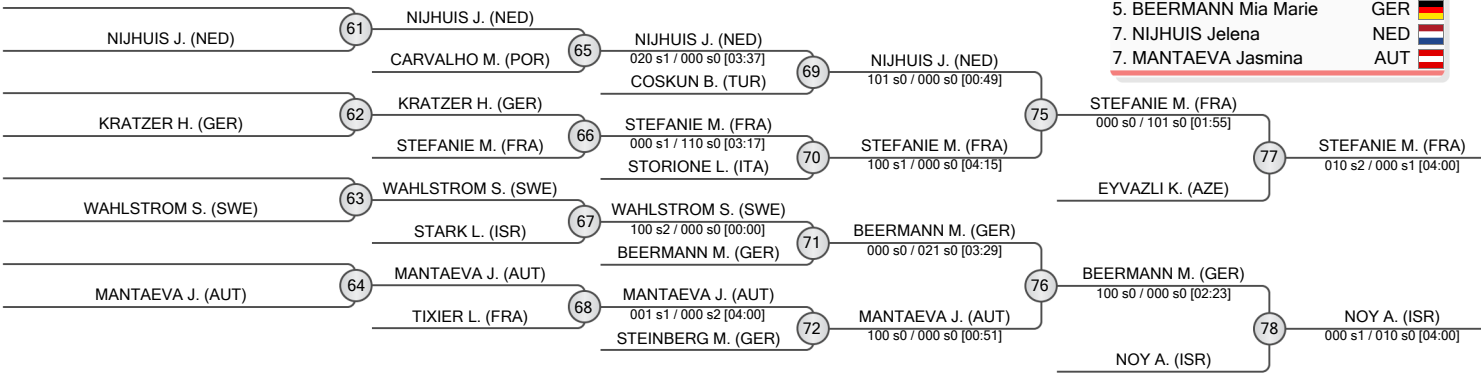



Berlin Millennium Team Cadet European Cup 2026

Germany, Berlin, 25-26 Apr 2026

-52 kg

Women (45)

POOL A

CHIRON Alexandra	MDA
KRZYZANIAK Zoe	GER
MARTIN TORRES Jimena	ESP
AKERSTROM Thelma	SWE
GUION Sofia	ITA
GOECKERITZ Leni	GER
SOUSA LAVANDEIRA Zeltia	ESP
WELLEKENS Amelie	BEL
KING Hannah	GBR
GUPALO Liana	GER
DOUMBIA Salma	FRA

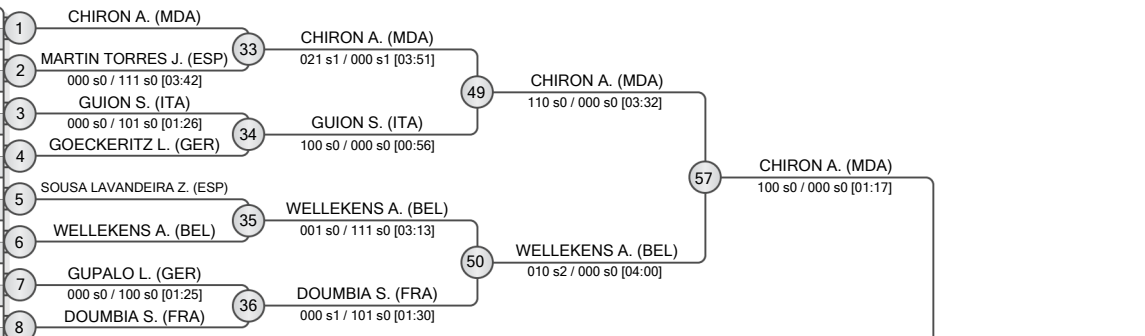

POOL B

TUERK Helin	AUT
BUZINA Anastasia	EST
PETERSON Elsa	SWE
REITMANN Anna	GER
WOLSTER Gili Racheli	ISR
BROADLEY Maisie	GBR
AGHAMIRZAZADE Narmin	AZE
GERINGER Xenia	GER
TERES CEREZA Daniela	ESP
VAN DE RIJZEN Lieve	NED
WOERNER Daphne	GER

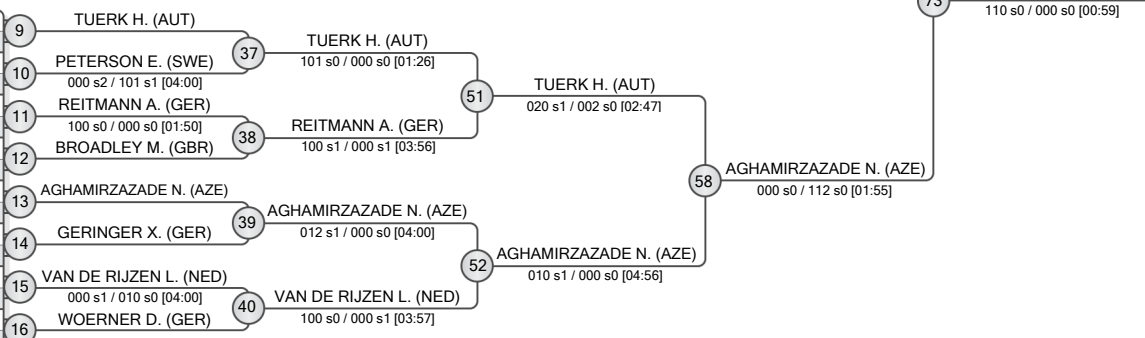

POOL C

YAHAV Yali	ISR
BABAYEVA Tovsiyya	AZE
LAMM Valentina	AUT
MANTYKENTTA Sara	FIN
LARSEN Ria	SUI
KUKIC Lana	GER
BOSKUP Aysenur	TUR
TSIONARAS Dora Eleana	GER
HELGESSION Emilia	SWE
VAINER Xenia	MDA
LOPEZ GORDO Sofia	ESP
JAEGER Sophie	GER

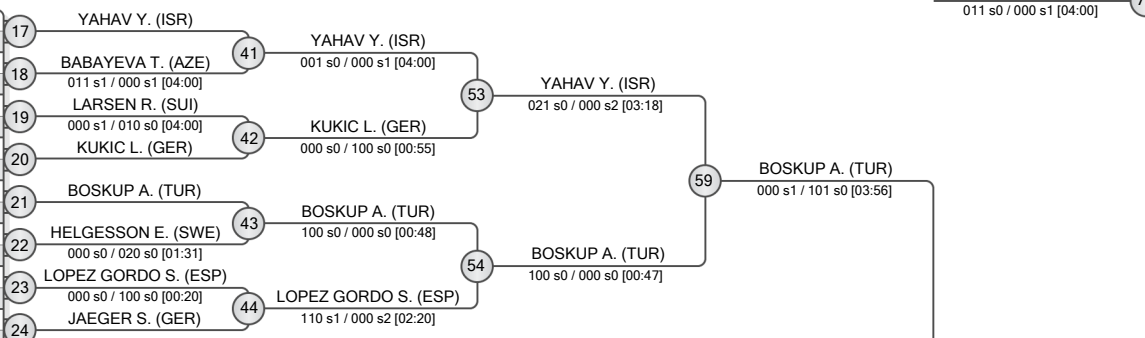

POOL D

VUKASOVIC Teodora	SRB
WEGELER Babette	GER
GRUBER Michelle	GER
CUSA Carla	ROU
PAUS Roni	ISR
FINDRIK Paula	CRO
DUBOSQ Ambre	FRA
ROMERA BARRAGAN Aniana	ESP
CEDERVALL CLAESSION Tilde	SWE
DALY Lucy	GBR
FOERSTER Mia	GER

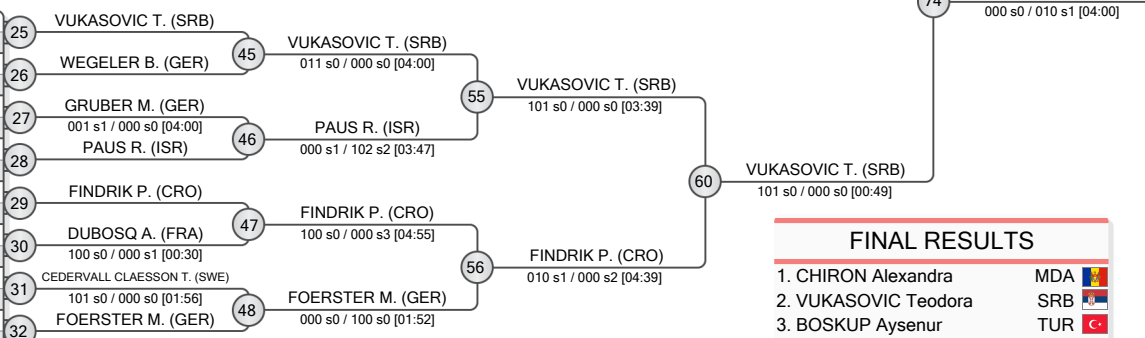

FINAL RESULTS

- CHIRON Alexandra MDA
- VUKASOVIC Teodora SRB
- BOSKUP Aysenur TUR
- AGHAMIRZAZADE Narmin AZE
- VAN DE RIJZEN Lieve NED
- YAHAV Yali ISR
- WELLEKENS Amelie BEL
- FINDRIK Paula CRO

REPECHAGE

MARTIN TORRES J. (ESP)	61	MARTIN TORRES J. (ESP)
GERINGER X. (GER)	62	GERINGER X. (GER)
HELGESSION E. (SWE)	63	HELGESSION E. (SWE)
WEGELER B. (GER)	64	WEGELER B. (GER)

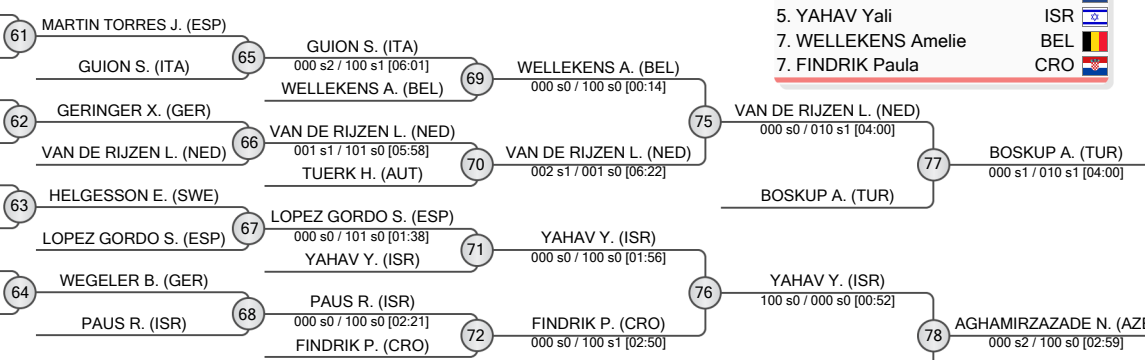



Berlin Millennium Team Cadet European Cup 2026

Germany, Berlin, 25-26 Apr 2026

-57 kg

Women (58)

POOL A

	KILIC Elif	TUR
	BOUVIL Clarisse	FRA
	VAN BAAL Sijmmie	NED
	EVERS Josephine	GER
	NATARIO Maria	POR
	YUSIFLI Samaya	AZE
	VENDRELL JUAN Alexia	ESP
	SHATTOCK Maisie	GBR
	BAECHLE Sophia	GER
	JANSEN Marie-Lise	BEL
	MELAMED Lee	ISR
	ALIMOVA Zuhra	UZB
	BLANK Emilia	GER
	KILDEEVA Daria	FIN
	BORUBOLOTOVA Milena	KGZ

1	KILIC E. (TUR)	33	KILIC E. (TUR)
2	VAN BAAL S. (NED)	000 s0 / 002 s0 [04:00]	010 s1 / 000 s0 [04:00]
3	EVERS J. (GER)	100 s0 / 010 s0 [02:00]	000 s0 / 102 s0 [02:33]
4	YUSIFLI S. (AZE)	002 s0 / 000 s0 [04:00]	000 s0 / 102 s0 [02:33]
5	BAECHLE S. (GER)	000 s0 / 001 s0 [04:00]	101 s0 / 000 s0 [01:23]
6	JANSEN M. (BEL)	002 s0 / 000 s0 [04:00]	000 s0 / 001 s0 [04:00]
7	ALIMOVA Z. (UZB)	100 s0 / 000 s0 [00:00]	020 s0 / 000 s1 [03:44]
8	KILDEEVA D. (FIN)	100 s0 / 000 s0 [00:27]	

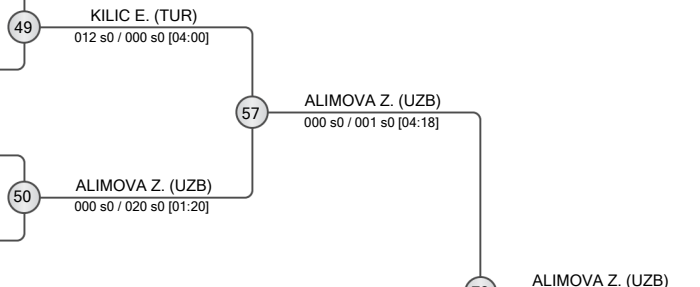

POOL B

	CEPELAKOVA Lucie	CZE
	PORCARI Miryam	ITA
	BACKLUND Nova	SWE
	NEUMANN Raphael	ISR
	STOEGMANN Isabella	AUT
	PETIDENT Ambre	FRA
	DRESSLER Lotta	GER
	PULJIC Lucija	CRO
	CHRISP Taylor	GBR
	BRAZINSKAITE Ieva	LTU
	ALONSO FERNANDEZ Sara	ESP
	RUSU Maria	MDA
	KRONENTHAL Charlotte	GER
	VALIZADA Sama	AZE

9	CEPELAKOVA L. (CZE)	37	CEPELAKOVA L. (CZE)
10	PORCARI M. (ITA)	101 s0 / 000 s0 [01:26]	001 s1 / 000 s2 [04:20]
11	NEUMANN R. (ISR)	001 s1 / 000 s1 [04:00]	000 s0 / 100 s2 [03:50]
12	PETIDENT A. (FRA)	101 s0 / 000 s1 [02:10]	000 s0 / 100 s2 [03:50]
13	PULJIC L. (CRO)		101 s1 / 000 s2 [04:00]
14	BRAZINSKAITE I. (LTU)	000 s0 / 010 s1 [04:00]	000 s0 / 100 s1 [02:09]
15	ALONSO FERNANDEZ S. (ESP)	011 s0 / 002 s0 [04:00]	
16	KRONENTHAL C. (GER)	100 s0 / 000 s0 [01:16]	

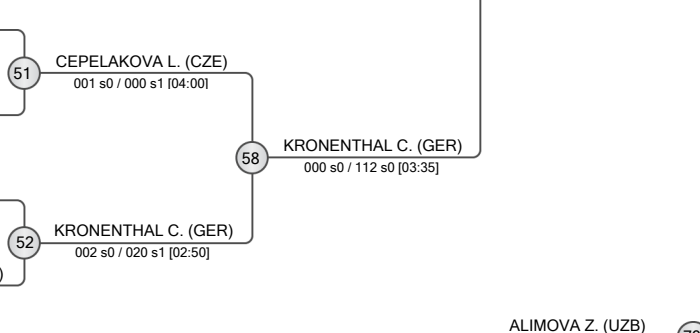

POOL C

	KHAZRATOVA Gulsanam	UZB
	TOPCU Ezgi	TUR
	HAYUN Romy	ISR
	SAS-ZALOZIECKI Valerie	AUT
	OUWERKERK Shayen	NED
	DANISOVA Ema	SVK
	BRIAND Lea	GER
	MEKAITON Shira	ISR
	GUERRERO PADIN Ines	ESP
	MAMMADTAGHIYEVA Gulnaz	AZE
	BAUER Sina Josefin	GER
	ACTIS Margherita	ITA
	NEBHUTH Sophia	GER
	KERSYTE Airuna	LTU
	MITCHELL Evie	GBR

17	KHAZRATOVA G. (UZB)	41	KHAZRATOVA G. (UZB)
18	TOPCU E. (TUR)	003 s0 / 001 s0 [04:00]	011 s0 / 000 s0 [04:00]
19	OUWERKERK S. (NED)	000 s0 / 022 s0 [03:24]	000 s0 / 022 s0 [03:24]
20	DANISOVA E. (SVK)	020 s0 / 000 s0 [01:49]	002 s0 / 000 s0 [04:00]
21	MEKAITON S. (ISR)	010 s1 / 000 s1 [04:00]	001 s2 / 000 s0 [04:00]
22	MAMMADTAGHIYEVA G. (AZE)	010 s0 / 000 s0 [04:00]	001 s2 / 000 s0 [04:00]
23	ACTIS M. (ITA)	100 s0 / 000 s3 [02:24]	002 s0 / 100 s0 [01:16]
24	MITCHELL E. (GBR)	000 s0 / 100 s0 [01:02]	100 s2 / 000 s2 [02:59]

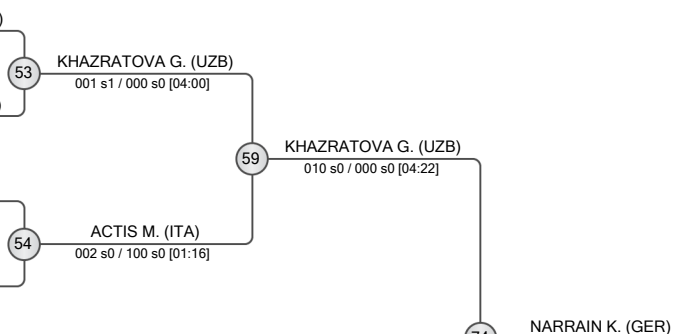

POOL D

	CHERNOVA Carina	POR
	MANECK Mia	GER
	CAMERON Stella	GBR
	ZINK Maxima	GER
	LUOTO Eila	FIN
	ABU JAHUR Ines	BEL
	BIXA Luzia	AUT
	HASID Daniella	ISR
	AHMADZADA Yaghmur	AZE
	BELLEVAL Jaines	FRA
	STAIU Patricia	ROU
	GRUEVA Dara	BUL
	NARRAIN Katharina	GER
	TASCON MARTIN Minerva	ESP

25	CHERNOVA C. (POR)	45	CHERNOVA C. (POR)
26	MANECK M. (GER)	100 s1 / 000 s1 [01:05]	100 s1 / 000 s1 [01:05]
27	CAMERON S. (GBR)	100 s2 / 000 s1 [01:52]	020 s0 / 000 s0 [00:41]
28	ZINK M. (GER)	100 s0 / 000 s0 [02:16]	110 s0 / 000 s0 [03:49]
29	LUOTO E. (FIN)	101 s0 / 000 s0 [01:16]	002 s1 / 000 s0 [04:00]
30	ABU JAHUR I. (BEL)	101 s0 / 000 s0 [01:16]	000 s0 / 101 s1 [03:25]
31	BIXA L. (AUT)	100 s0 / 000 s0 [01:12]	000 s0 / 101 s1 [02:12]
32	HASID D. (ISR)	000 s0 / 020 s0 [01:12]	000 s0 / 101 s1 [02:12]
33	BELLEVAL J. (FRA)	000 s0 / 020 s0 [01:12]	
34	GRUEVA D. (BUL)	000 s1 / 001 s1 [04:00]	
35	NARRAIN K. (GER)	000 s1 / 001 s1 [04:00]	
36	TASCON M. (ESP)	100 s0 / 000 s0 [01:18]	

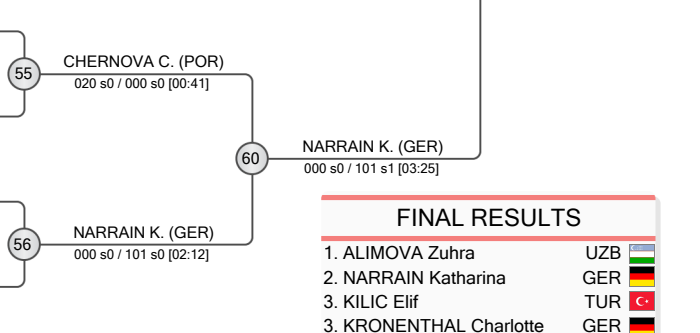

FINAL RESULTS		
1.	ALIMOVA Zuhra	UZB
2.	NARRAIN Katharina	GER
3.	KILIC Elif	TUR
4.	KRONENTHAL Charlotte	GER
5.	KHAZRATOVA Gulsanam	UZB
6.	CHERNOVA Carina	POR
7.	CEPELAKOVA Lucie	CZE
8.	OUWERKERK Shayen	NED

REPECHAGE

61	KILDEEVA D. (FIN)	000 s0 / 100 s0 [00:00]
62	ALONSO FERNANDEZ S. (ESP)	000 s1 / 111 s0 [02:09]
63	TOPCU E. (TUR)	
64	GRUEVA D. (BUL)	

65	BAECHLE S. (GER)	001 s2 / 000 s1 [04:00]
66	PULJIC L. (CRO)	000 s0 / 020 s0 [02:21]
67	OUWERKERK S. (NED)	000 s0 / 110 s0 [01:10]
68	HASID D. (ISR)	000 s0 / 101 s0 [01:37]

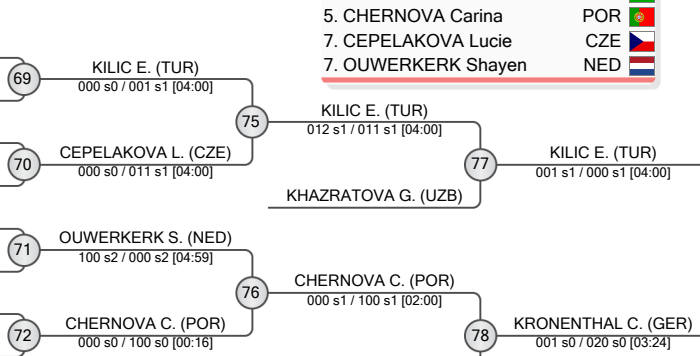



Berlin Millennium Team Cadet European Cup 2026

Germany, Berlin, 25-26 Apr 2026

-63 kg

Women (48)

POOL A

	BILEN Sevim Margaret	TUR
	KUTKEVICA Sofija	LAT
	SMITH Kayla	GBR
	VAN SON Frederique	NED
	LUEDTKE Lea Sophie	GER
	ROITBERG Emma	ITA
	VON LUTZ Sophia	AUT
	CALDEIRA Matilde	POR
	GONZALEZ ROMANILLOS Leyre	ESP
	CHIRILA Annalisa Nicole	ROU
	VALIYEVA Nazakat	AZE
	GRAFE Lene	GER

1	BILEN S. (TUR)	
2	SMITH K. (GBR)	33
3	VAN SON F. (NED)	
4	ROITBERG E. (ITA)	34
5	VON LUTZ S. (AUT)	
6	CALDEIRA M. (POR)	35
7	VALIYEVA N. (AZE)	
8	GRAFE L. (GER)	36

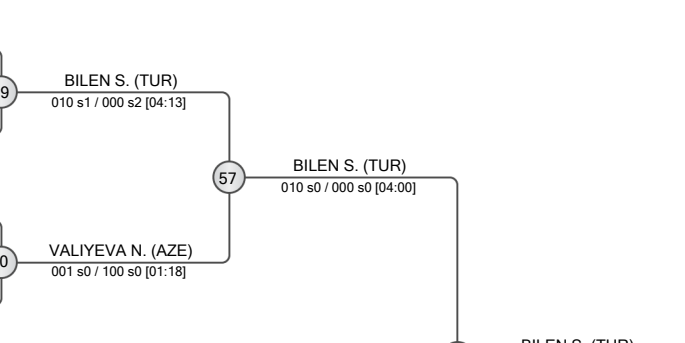

POOL B

	YILMAZ Duru	TUR
	BARONI Chiara	SUI
	GARCIA MONTES Judith Eloisa	ESP
	ROEMMER Amelie	GER
	LE TOUZE Lou	FRA
	KULIKAUSKAITE Meida	LTU
	STOEVA Andrea	BUL
	MUSAZZI Asia	ITA
	SHADI Gaida	AUT
	STOCK Luisa	GER
	KADYRKULOVA Medina	KGZ
	KROL Adel	ISR

9	YILMAZ D. (TUR)	
10	BARONI C. (SUI)	37
11	LE TOUZE L. (FRA)	
12	KULIKAUSKAITE M. (LTU)	38
13	STOEVA A. (BUL)	
14	SHADI G. (AUT)	39
15	STOCK L. (GER)	
16	KROL A. (ISR)	40

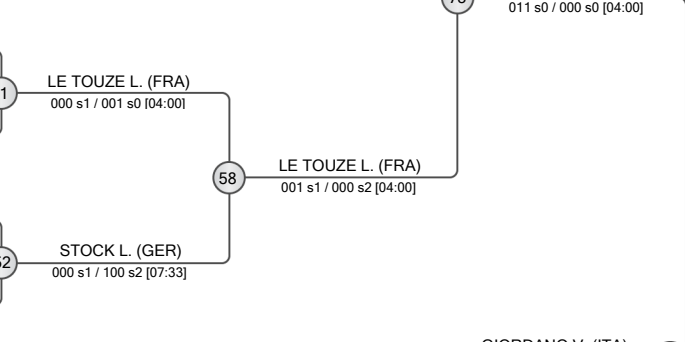

POOL C

	MASHURENKO Arina	UKR
	MATOUSKOVA Valentyna	CZE
	RODRIGUEZ SAENZ Ines	ESP
	BUETTNER Antonia	GER
	VASCO Ines	POR
	TREMBATCH Anna	FRA
	GLIGA Ana	ROU
	KAIN Kiara	AUT
	KOHLMANNLEHNER Nadja Alexandra	GER
	HUSEYNLI Zilan	AZE
	ZYGOMALA Ilektra	GRE
	BALYKIN Eden	ISR

17	MASHURENKO A. (UKR)	
18	MATOUSKOVA V. (CZE)	41
19	BUETTNER A. (GER)	
20	TREMBATCH A. (FRA)	42
21	GLIGA A. (ROU)	
22	KAIN K. (AUT)	43
23	HUSEYNLI Z. (AZE)	
24	BALYKIN E. (ISR)	44

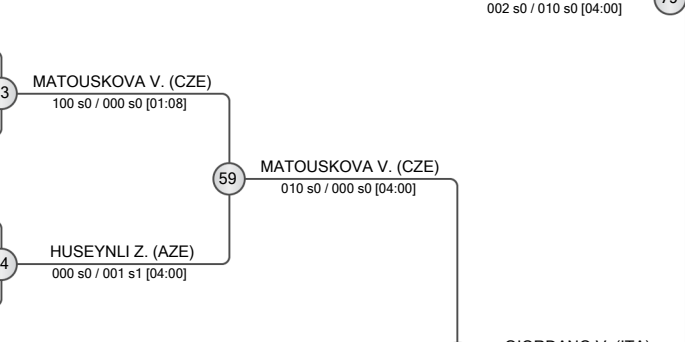

POOL D

	RAMA Bleona	AUT
	BJORK DALBERG Lova	SWE
	ZAHHAROVA Anastasia	EST
	GUENTHER Salima	GER
	ZHARASHUEVA Hanifa	BEL
	CRISOSTOMO Joana Filipa	POR
	KYIALBEKOVA Aaisha	KGZ
	STRUJJK Jayda	NED
	MAMMADLI Turkan	AZE
	BESTAV Selin	TUR
	GIORDANO Valeria	ITA
	VOLK Latika	GER

25	RAMA B. (AUT)	
26	ZAHHAROVA A. (EST)	45
27	GUENTHER S. (GER)	
28	CRISOSTOMO J. (POR)	46
29	KYIALBEKOVA A. (KGZ)	
30	STRUJJK J. (NED)	47
31	GIORDANO V. (ITA)	
32	VOLK L. (GER)	48

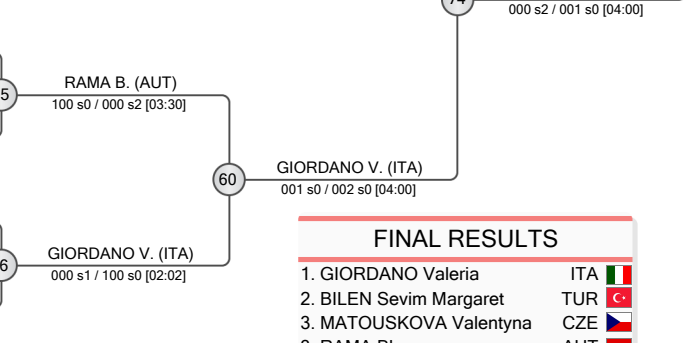

FINAL RESULTS		
1.	GIORDANO Valeria	ITA
2.	BILEN Sevim Margaret	TUR
3.	MATOUSKOVA Valentyna	CZE
3.	RAMA Bleona	AUT
5.	VAN SON Frederique	NED
5.	LE TOUZE Lou	FRA
7.	STOCK Luisa	GER
7.	HUSEYNLI Zilan	AZE

REPECHAGE

61	SMITH K. (GBR)	
62	ROEMMER A. (GER)	
63	MASHURENKO A. (UKR)	
64	BESTAV S. (TUR)	

65	VAN SON F. (NED)	
66	ROEMMER A. (GER)	
67	MASHURENKO A. (UKR)	
68	BESTAV S. (TUR)	

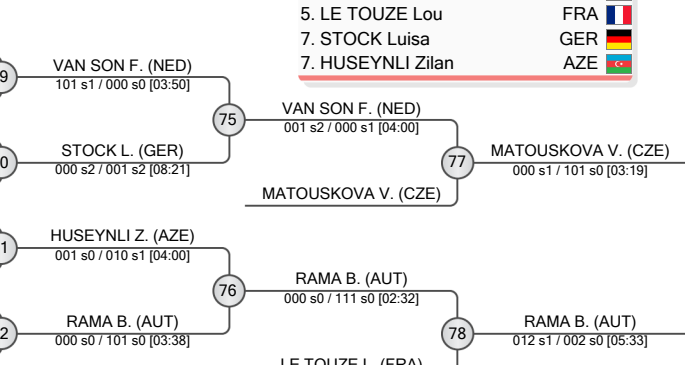



Berlin Millennium Team Cadet European Cup 2026

Germany, Berlin, 25-26 Apr 2026

-70 kg

Women (33)

POOL A

	WOEGERER Selina	AUT	1
	DAVIES Robyn	GBR	2
	KARATAS Busra	TUR	3
	PILZ Amelie Fabienne	GER	4
	VENDRIG Esmee	NED	5
	LEANZA Dorina	BEL	6
	MALCZAK Lara Katharina	GER	7
	MBENGUE RUANO Deguene Aisha	ESP	8

1	WOEGERER S. (AUT)	33	WOEGERER S. (AUT)	100 s0 / 000 s0 [00:20]
2	DAVIES R. (GBR)			
3	KARATAS B. (TUR)			
4	PILZ A. (GER)	34	PILZ A. (GER)	002 s0 / 100 s1 [02:34]
5	VENDRIG E. (NED)			
6	LEANZA D. (BEL)	35	VENDRIG E. (NED)	100 s2 / 000 s3 [02:40]
7	MALCZAK L. (GER)			
8	MBENGUE RUANO D. (ESP)	36	MALCZAK L. (GER)	001 s2 / 000 s0 [04:00]

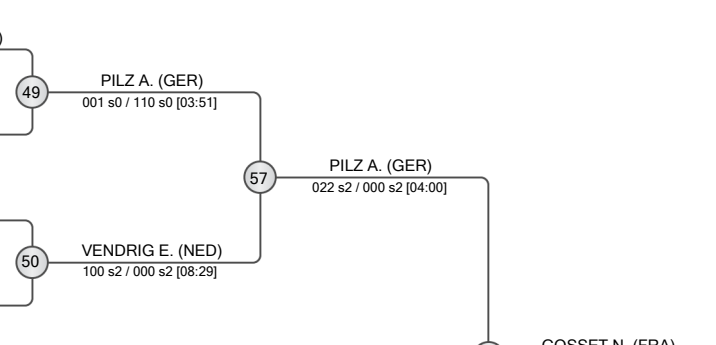

POOL B

	FILZWIESER Emma	AUT	9
	KUCEROVA Anna	CZE	10
	PAPAIIOANNOU Maria Eleni	GRE	11
	KOCNIK Mia Juno	GER	12
	MAMMADLI Masuma	AZE	13
	MEGLAJ Erika	CRO	14
	GOSSET Norah	FRA	15
	WIKENE Ingrid	NOR	16

9	FILZWIESER E. (AUT)	37	KUCEROVA A. (CZE)	000 s0 / 020 s1 [03:38]
10	KUCEROVA A. (CZE)			
11	PAPAIIOANNOU M. (GRE)			
12	KOCNIK M. (GER)	38	PAPAIIOANNOU M. (GRE)	010 s2 / 000 s1 [04:00]
13	MAMMADLI M. (AZE)			
14	MEGLAJ E. (CRO)	39	MAMMADLI M. (AZE)	100 s0 / 000 s0 [00:18]
15	GOSSET N. (FRA)			
16	WIKENE I. (NOR)	40	GOSSET N. (FRA)	020 s0 / 000 s0 [01:45]

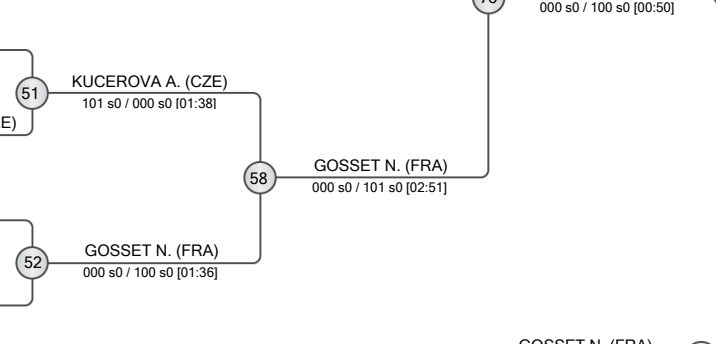

POOL C

	KARAFFOVA Vanessa	CZE	17
	AHMADOVA Rena	AZE	18
	GIL LEITAO Madalena	POR	19
	KEDING Svenja	GER	20
	OZBUDAK Done Melike	TUR	21
	ZSCHIESCHE Frieda Hanni	GER	22
	AUBRY Omairaa	FRA	23
	ZAPOROJANU Sofia	MDA	24

17	KARAFFOVA V. (CZE)	41	KARAFFOVA V. (CZE)	020 s0 / 000 s1 [01:21]
18	AHMADOVA R. (AZE)			
19	GIL LEITAO M. (POR)	42	GIL LEITAO M. (POR)	021 s0 / 001 s0 [02:06]
20	KEDING S. (GER)			
21	OZBUDAK D. (TUR)	43	OZBUDAK D. (TUR)	011 s0 / 000 s1 [04:00]
22	ZSCHIESCHE F. (GER)			
23	AUBRY O. (FRA)	44	AUBRY O. (FRA)	012 s0 / 001 s1 [04:00]
24	ZAPOROJANU S. (MDA)			

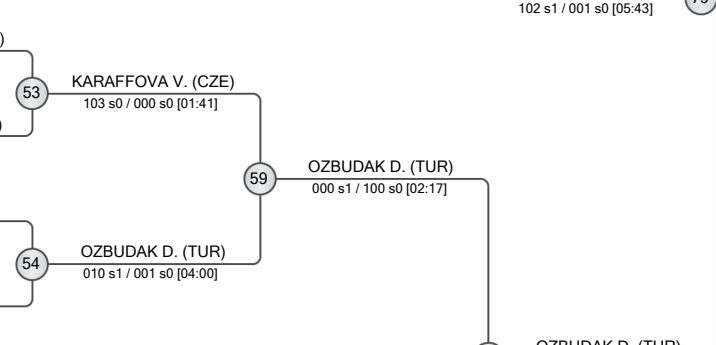

POOL D

	HUDIKA Vita	CRO	25
	ZUIDWIJK Noel	NED	26
	LATKOWSKI Antonia	GER	27
	RABL Nia	AUT	28
	FARAUANU Iasmina	ROU	28
	ZELL Amit	ISR	29
	THIERY Emilie	GER	30
	GALBRAITH Zoe	GBR	31
	JUMABAEVA Poshshajon	UZB	32

25	HUDIKA V. (CRO)	45	ZUIDWIJK N. (NED)	001 s2 / 010 s1 [04:00]
26	ZUIDWIJK N. (NED)			
27	LATKOWSKI A. (GER)	46	LATKOWSKI A. (GER)	100 s0 / 000 s0 [02:50]
28	FARAUANU I. (ROU)			
29	ZELL A. (ISR)	47	ZELL A. (ISR)	001 s0 / 000 s0 [04:00]
30	THIERY E. (GER)			
31	GALBRAITH Z. (GBR)	48	JUMABAEVA P. (UZB)	000 s3 / 100 s0 [02:46]
32	JUMABAEVA P. (UZB)			

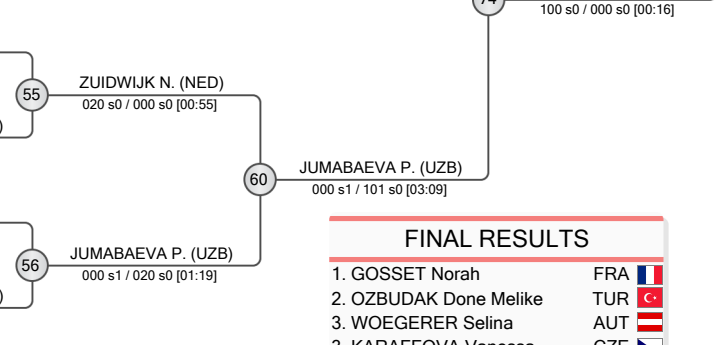

FINAL RESULTS		
1.	GOSSET Norah	FRA
2.	OZBUDAK Done Melike	TUR
3.	WOEGERER Selina	AUT
3.	KARAFFOVA Vanessa	CZE
5.	JUMABAEVA Poshshajon	UZB
5.	PILZ Amelie Fabienne	GER
7.	KUCEROVA Anna	CZE
7.	ZELL Amit	ISR

REPECHAGE

61	KARATAS B. (TUR)			
62	WIKENE I. (NOR)			
63	ZSCHIESCHE F. (GER)			
64	GALBRAITH Z. (GBR)			

65	WOEGERER S. (AUT)	65	WOEGERER S. (AUT)	000 s1 / 010 s1 [04:00]
66	WIKENE I. (NOR)			
67	ZSCHIESCHE F. (GER)	67	AUBRY O. (FRA)	000 s0 / 020 s0 [01:54]
68	GALBRAITH Z. (GBR)			

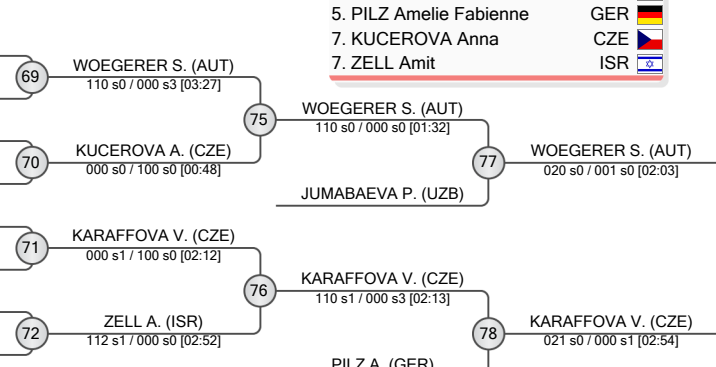



Berlin Millennium Team Cadet European Cup 2026

Germany, Berlin, 25-26 Apr 2026

+ 70 kg

Women (16)

POOL A

- BALCI Hatice Tuana (TUR)
- WANDJI Maelyne (FRA)
- VAN DRIEL Nova (NED)
- BARNEKOW Lena Sophie (GER)

POOL B

- PALERMO Elisa (ITA)
- MOROU Hidaya (GER)
- MAGASSA FOFANA Sogona (ESP)
- VAN SUNDERT Fleur (NED)

POOL C

- COULIBALY TOURE Ballalo (ESP)
- DECKER Meerit (GER)
- SASSA-TATUKILA Therese-Grace (FRA)
- HERMANS Tess (NED)

POOL D

- CHERKELIEVA Maria (BUL)
- CONRAD Lucia (DEN)
- ALIYEVA Zemfira (AZE)
- BUSCHMANN Elisabeth (GER)

REPECHAGE

- WANDJI M. (FRA)
- VAN DRIEL N. (NED)
- VAN SUNDERT F. (NED)
- PALERMO E. (ITA)
- HERMANS T. (NED)
- COULIBALY TOURE B. (ESP)
- CONRAD L. (DEN)
- ALIYEVA Z. (AZE)

