



Berlin Millennium Team Cadet European Cup 2026

Germany, Berlin, 25-26 Apr 2026

-50 kg

Men (50)

POOL A

	GAT MUALEM Hillel	ISR
	FOTA Mina Robin	ROU
	CABEZAS SEVILLA Victor	ESP
	GAFFARLI Ali	GER
	GEUNS Gust	BEL
	ZUBETS Rodion	EST
	SEGUIN Louie	GBR
	ROLNICKI Alon	ISR
	MATANOVIC Luka	SRB
	POELSTRA Ferron	NED
	MUNTEANU Ruslan	MDA
	SPURK Paul	GER
	LAHRIFI Moulay-Mountasir	FRA

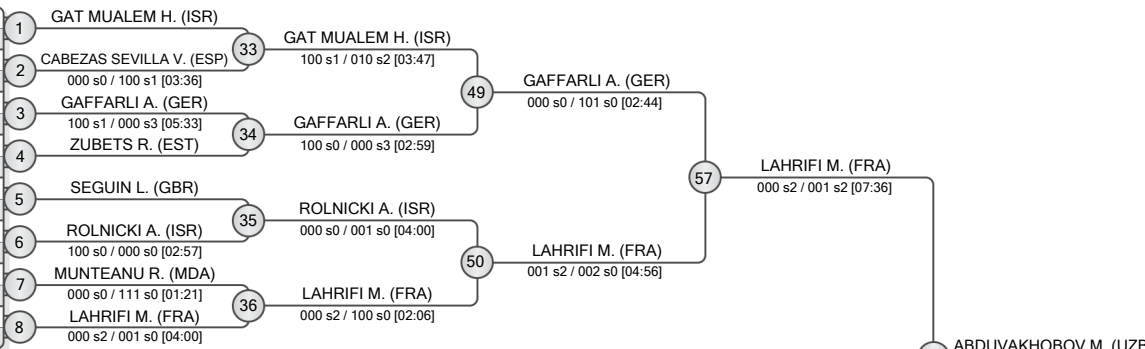

POOL B

	DOGRU Suleyman	TUR
	ILCHEV Martin	BUL
	PATZ John-Lukas	GER
	JASAITIS Rokas	LTU
	LOPEZ PEREIRA Hugo	ESP
	KOSLAEV Muhammad	AUT
	ABDUVAKHOBOV Mamurjon	UZB
	PALMAERTS Jolan	BEL
	KRETZSCHMAR Dwayne	GER
	MAST Tom	ISR
	ALVES Andre Henrique	POR
	MAMATOV Ariet	KGZ

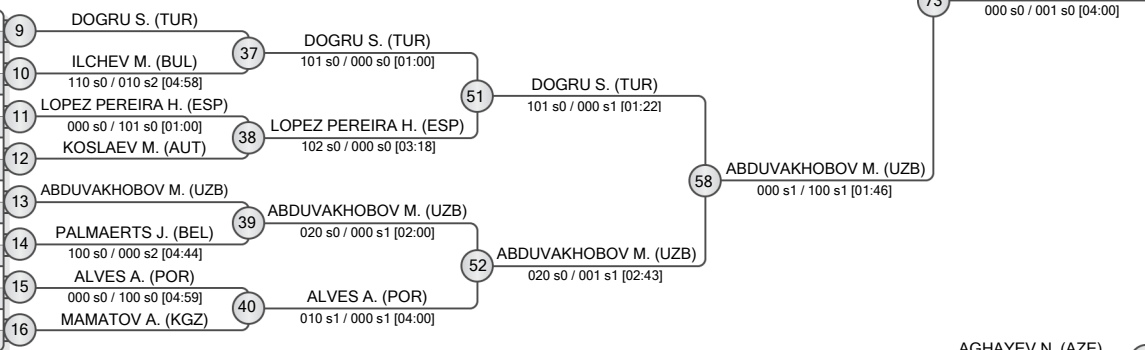

POOL C

	HEIMANS Klaas	NED
	TANASI Sando	LAT
	DOBROVOLSIS Mantas	LTU
	NAKASH Itai	ISR
	MOUSSAID Mehdi	BEL
	DAVYDOV Henry	GER
	YAGUE LANCHA Ruben	ESP
	SOUKUP Matyas	CZE
	RAHMANI Noam	ISR
	BERNUZ Hugo	FRA
	MURTAZALIEV Samad	AUT
	ISHENALIEV Syimyk	KGZ
	MAMETIEV Roman	GER

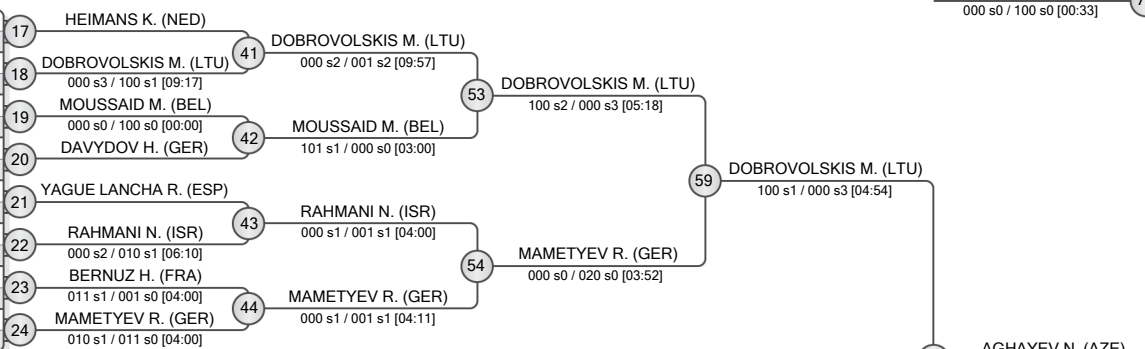

POOL D

	KELLER Aaron Joshua	GER
	MINZAT Marius	MDA
	ASIK Taha Baran	TUR
	LEVINGER Ehud	ISR
	DEWULF Lorn	BEL
	BLASCO PEREZ Imanol	ESP
	STOLAKIS Mariano	GER
	QUINTINO Armando	POR
	TUDOR Alin	ROU
	MAISURADZE Mate	GEO
	AGHAYEV Nihad	AZE
	SCHMIDT Constantin Matthias	GER

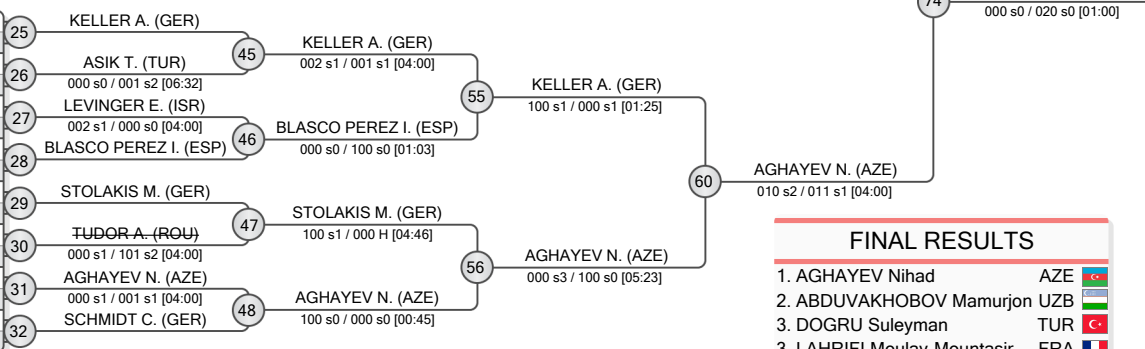

FINAL RESULTS

- AGHAYEV Nihad
- ABDUVAKHOBOV Mamurjon
- DOGRU Suleyman
- LAHRIFI Moulay-Mountasir
- DOBROVOLSIS Mantas
- HEIMANS Klaas
- ROLNICKI Alon
- KELLER Aaron Joshua

REPECHAGE

SPURK P. (GER)	61	MUNTEANU R. (MDA)	65	ROLNICKI A. (ISR)	69	ROLNICKI A. (ISR)
MUNTEANU R. (MDA)		ROLNICKI A. (ISR)		GAFFARLI A. (GER)		
PALMAERTS J. (BEL)	62	PALMAERTS J. (BEL)	66	PALMAERTS J. (BEL)	70	DOGRU S. (TUR)
TANASI S. (LAT)		ALVES A. (POR)		DOGRU S. (TUR)		
HEIMANS K. (NED)	63	HEIMANS K. (NED)	67	HEIMANS K. (NED)	71	HEIMANS K. (NED)
MAISURADZE M. (GEO)		MOUSSAID M. (BEL)		MAMETIEV R. (GER)		
SCHMIDT C. (GER)	64	MAISURADZE M. (GEO)	68	STOLAKIS M. (GER)	72	KELLER A. (GER)
		STOLAKIS M. (GER)		KELLER A. (GER)		

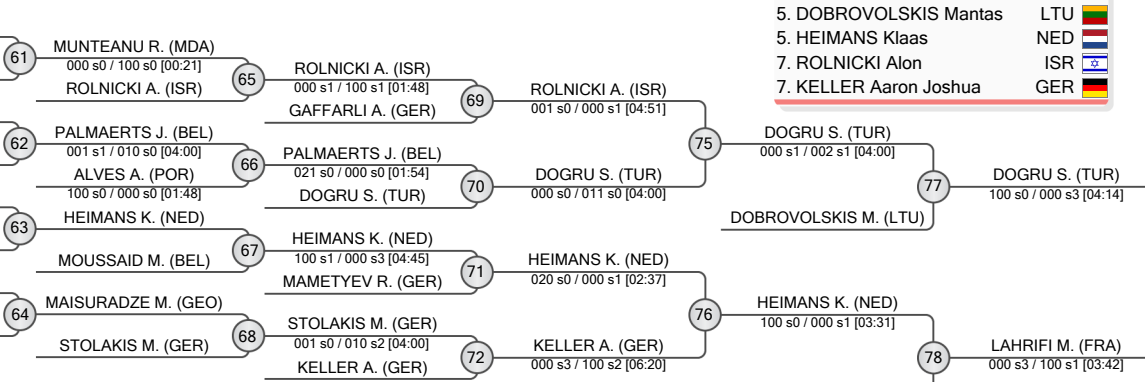



Berlin Millennium Team Cadet European Cup 2026

Germany, Berlin, 25-26 Apr 2026

-55 kg

Men (63)

POOL A

1	UYAR Celil (NED)	1	UYAR C. (NED)
2	LEUPOLD Ansgar Thorben (GER)	2	BEN LULU J. (ISR)
3	BEN LULU Jonathan (ISR)	3	KREMER A. (GER)
4	KREMER Arthur (GER)	4	DE LAURENTIS M. (ITA)
5	DOCHERTY Jack (GBR)	5	PICKEL D. (ISR)
6	BIOSCA GARCIA Renat (ESP)	6	KOKKONEN V. (FIN)
7	DE LAURENTIS Mattia (ITA)	7	NOETZEL L. (GER)
8	PICKEL Daniel (ISR)	8	VUSHEV A. (BUL)
9	SEFSAF Hamza (BEL)		
10	KOKKONEN Valtteri (FIN)		
11	DREWS Fabian (GER)		
12	RACKAUSKAS Ignas (LTU)		
13	NOETZEL Linus (GER)		
14	SINAGINS Nils (LAT)		
15	VUSHEV Aleksandar (BUL)		

POOL B

9	KHALILLI Rza (AZE)	9	ISMAILOV B. (KGZ)
10	ISMAILOV Baiel (KGZ)	10	TANSINGCO G. (GER)
11	TANSINGCO Gabryl (GER)	11	FUCHS Y. (ISR)
12	AMARAL Joao (POR)	12	GARVE S. (GER)
13	BROWN Ishmael (GBR)	13	TALIBOV I. (AZE)
14	FUCHS Yuval (ISR)	14	PETROSINO E. (ITA)
15	GARVE Sou (GER)	15	GAFFARLI A. (GER)
16	LEGER VILLA Lucien (FRA)	16	ROMI G. (ISR)
17	TALIBOV Ibrahim (AZE)		
18	PANDAY Diego (NED)		
19	KURBANOV Djamil (AUT)		
20	PETROSINO Errico (ITA)		
21	GAFFARLI Al-Hasan (GER)		
22	OLARASU Constantin (MDA)		
23	ROMI Guy (ISR)		
24	LEMONS RODRIGUEZ Omar (ESP)		

POOL C

17	SHREBERK Guy (ISR)	17	SHREBERK G. (ISR)
18	EVERS Fynn (GER)	18	KHUDIYEV F. (AZE)
19	KHUDIYEV Farid (AZE)	19	BLACKSHAW R. (GBR)
20	ZIRAKASHVILI Merabi (GEO)	20	KAMCHYBEKOV Y. (KGZ)
21	BLACKSHAW Reece (GBR)	21	SHVARTS A. (ISR)
22	BARAK Davor (GER)	22	LASICA A. (CRO)
23	HILARIO Rodrigo (POR)	23	DOUINE M. (ITA)
24	KAMCHYBEKOV Yiman (KGZ)	24	MANSUR X. (NED)
25	SHVARTS Amit (ISR)		
26	VLAD Sorin (ROU)		
27	VUSHEV Mihail (BUL)		
28	LASICA Andrej (CRO)		
29	TABACHNIK Liam (ISR)		
30	DOUINE Matteo (ITA)		
31	MANSUR Xavio (NED)		
32	PETROV Stephan (GER)		

POOL D

25	YUSUPOV Bobur (UZB)	25	YUSUPOV B. (UZB)
26	SILEN Topi (FIN)	26	IEVINS M. (LAT)
27	BERMAN Shayan (ISR)	27	JAKL M. (CZE)
28	IEVINS Martins (LAT)	28	FELLOUKA L. (CYP)
29	JAKL Marek (CZE)	29	FELLOUKA Loizos (CYP)
30	MUELLER Andrej (GER)	30	ASILBEKOV R. (KGZ)
31	HUNTER Luke (GBR)	31	HARDT C. (GER)
32	FELLOUKA Loizos (CYP)	32	TARASOV A. (ISR)
33	USMONOV Shokhjakhon (UZB)	33	BAUER E. (GER)
34	ASILBEKOV Ramis Stalbekovich (KGZ)		
35	HARDT Constantin (GER)		
36	JOERGENSEN Romeo (DEN)		
37	RHODES Lewis (GBR)		
38	TARASOV Aleksander (ISR)		
39	LLENA CARDIL Ivan (ESP)		
40	BAUER Eddie (GER)		

REPECHAGE

61	BEN LULU J. (ISR)	61	BEN LULU J. (ISR)
62	PANDAY D. (NED)	62	PETROSINO E. (ITA)
63	PETROSINO E. (ITA)	63	SHREBERK G. (ISR)
64	ZIRAKASHVILI M. (GEO)	64	SILEN T. (FIN)
65	DE LAURENTIS M. (ITA)	65	JAKL M. (CZE)
66	PETROSINO E. (ITA)	66	ASILBEKOV R. (KGZ)
67	SHREBERK G. (ISR)	67	SHREBERK G. (ISR)
68	SILEN T. (FIN)	68	ASILBEKOV R. (KGZ)
69	DE LAURENTIS M. (ITA)	69	DE LAURENTIS M. (ITA)
70	PETROSINO E. (ITA)	70	PETROSINO E. (ITA)
71	SHREBERK G. (ISR)	71	SHREBERK G. (ISR)
72	JAKL M. (CZE)	72	ASILBEKOV R. (KGZ)
73	TALIBOV I. (AZE)	73	TALIBOV I. (AZE)
74	KHUDIYEV F. (AZE)	74	KHUDIYEV F. (AZE)
75	PETROSINO E. (ITA)	75	PETROSINO E. (ITA)
76	SHREBERK G. (ISR)	76	SHREBERK G. (ISR)
77	YUSUPOV B. (UZB)	77	YUSUPOV B. (UZB)
78	UYAR C. (NED)	78	UYAR C. (NED)
79	KHUDIYEV F. (AZE)	79	KHUDIYEV F. (AZE)

FINAL RESULTS		
1.	KHUDIYEV Farid	AZE
2.	TALIBOV Ibrahim	AZE
3.	YUSUPOV Bobur	UZB
3.	UYAR Celil	NED
5.	PETROSINO Errico	ITA
5.	SHREBERK Guy	ISR
7.	PICKEL Daniel	ISR
7.	ASILBEKOV Ramis Stalbekovich	KGZ





Berlin Millennium Team Cadet European Cup 2026

Germany, Berlin, 25-26 Apr 2026

-60 kg

Men (89)

POOL A

	CORI Timeo	SUI	1	CORI T. (SUI)
	PUSEY Stanley	GBR	2	SCHREURS P. (NED)
	SCHREURS Pim	NED		001 s0 / 002 s0 [04:00]
	PLUHATYROV Roman	GER	3	DASKAL E. (ISR)
	DASKAL Eyal	ISR		000 s0 / 012 s0 [04:00]
	HRISTOV Emo	BUL	4	HRISTOV E. (BUL)
	ZYCHLINSKI Ide	ISR	5	ZYCHLINSKI I. (ISR)
	LAZORKINS Timofejs	LAT	6	LAZORKINS T. (LAT)
	MEZHIEV Rasul	GER	7	MEZHIEV R. (GER)
	KOLOSOV Kristo	EST		013 s0 / 010 s0 [04:00]
	BISTRICEANU Luca	ROU	8	BISTRICEANU L. (ROU)
	CARABOTTO Gabriele	ITA	9	CARABOTTO G. (ITA)
	BLAZHKO Oleksandr	AUT	10	BLAZHKO O. (AUT)
	USINASHVILI Andro	GEO	11	USINASHVILI A. (GEO)
	CABECANA Phil	GER		100 s0 / 000 s0 [05:17]
	FILISTOVICH Maksim	SWE	12	FILISTOVICH M. (SWE)
	BURLACU CACALETEANU Vlad Andreas	ESP	13	BURLACU CACALETEANU V. (ESP)
	PINTRIJEL David	ROU		100 s0 / 000 s0 [04:49]
	RAIDOS Aristotelis	GER	14	RAIDOS A. (GER)
	GOLUBOVSKIJ Liutauras	LTU	15	PAULA L. (POR)
	PAULA Lourenco	POR		000 s0 / 100 s0 [01:08]
	WINKLER Inbar	ISR	16	WINKLER I. (ISR)
				001 s0 / 100 s1 [03:29]

POOL B

	GUR Ramazan Aykut	TUR	17	GUR R. (TUR)
	ASGAROV Mehman	AZE	18	ASGAROV M. (AZE)
	LUTZ Georgiy	GER		100 s0 / 000 s3 [03:39]
	SAMARTZIDIS Sergios	AUT	19	SAMARTZIDIS S. (AUT)
	CAVALJI Serzhei	CZE		100 s0 / 000 s0 [00:31]
	HENSSENS Noah	BEL	20	HENSSENS N. (BEL)
	KASIS Noam	ISR	21	KASIS N. (ISR)
	DAMIAN Veaceslav	ROU		100 s0 / 000 s0 [00:50]
	GALIMZHANOV Kainazar	KGZ	22	GALIMZHANOV K. (KGZ)
	MONTES OLIVA Lucas	ESP	23	NICOLAS T. (FRA)
	NICOLAS Thibault	FRA		000 s0 / 101 s0 [02:01]
	SCHUBERT Moritz	GER	24	SCHUBERT M. (GER)
	KOSTOEV Adam	SWE	25	KOSTOEV A. (SWE)
	LOKK Dmitry	GER	26	SATTOROV A. (UZB)
	SATTOROV Abubakr	UZB		000 s2 / 020 s0 [03:04]
	LOWENSTERN Nadav	ISR	27	LOWENSTERN N. (ISR)
	HOFFMANN Linus	GER		100 s0 / 000 s0 [00:09]
	RICHARDSON Michael	GBR	28	RICHARDSON M. (GBR)
	SCHUMANN Janek Paul	GER	29	SLOBODIAN V. (FIN)
	SLOBODIAN Vladyslav	FIN		000 s0 / 101 s2 [03:37]
	MIGUNOV GOMEZ Maksim	ESP	30	MIGUNOV GOMEZ M. (ESP)
				000 s3 / 100 s1 [05:02]
	MARLAIS Oliver Vlaho	CRO	31	MARLAIS O. (CRO)
	GOLDSHMIDT Eli	ISR	32	GOLDSHMIDT E. (ISR)
				000 s1 / 100 s0 [01:28]

REPECHAGE

	CABECANA P. (GER)			CABECANA P. (GER)
	FILISTOVICH M. (SWE)	125		CARABOTTO G. (ITA)
			129	CARABOTTO G. (ITA)
	LOKK D. (GER)			WINKLER I. (ISR)
	KOSTOEV A. (SWE)	126		KOSTOEV A. (SWE)
	OSTERBERG S. (SWE)		130	RICHARDSON M. (GBR)
	MILIC M. (MNE)	127		OSTERBERG S. (SWE)
	GELBARD N. (ISR)		131	GROSS I. (ISR)
	MIHUT S. (ROU)	128		GELBARD N. (ISR)
			132	GROMYK D. (GER)
				GROMYK D. (GER)
				SANCES TURON M. (ESP)
				SANCES TURON M. (ESP)
				CHIARRONI CUTILLAS A. (ESP)

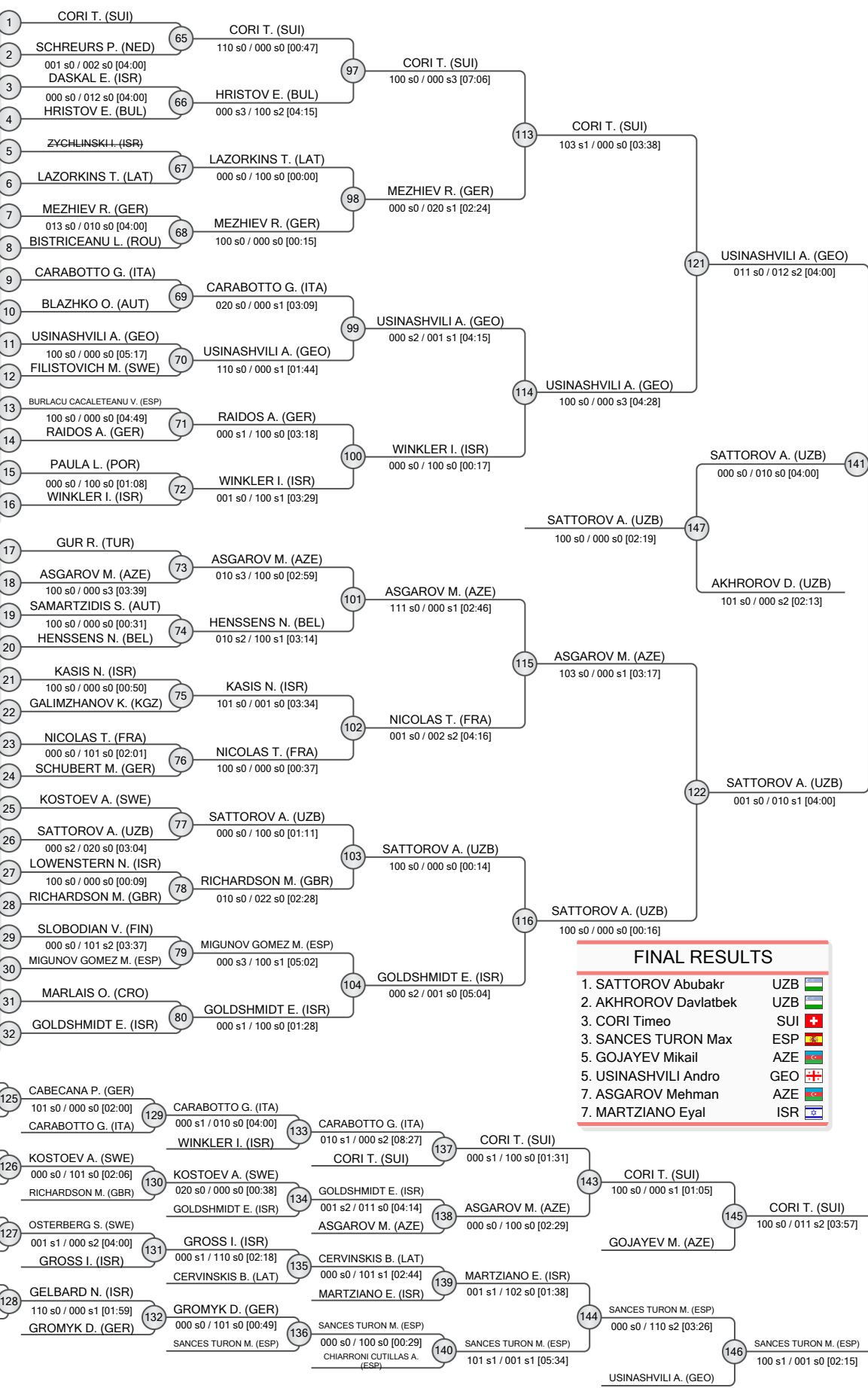

FINAL RESULTS	
1. SATTOROV Abubakr	UZB
2. AKHROV D. Davlatbek	UZB
3. CORI Timeo	SUI
5. GOJAYEV Mikail	AZE
5. USINASHVILI Andro	GEO
7. ASGAROV Mehman	AZE
7. MARTZIANO Eyal	ISR





Berlin Millennium Team Cadet European Cup 2026

Germany, Berlin, 25-26 Apr 2026

-60 kg

Men (89)

POOL C

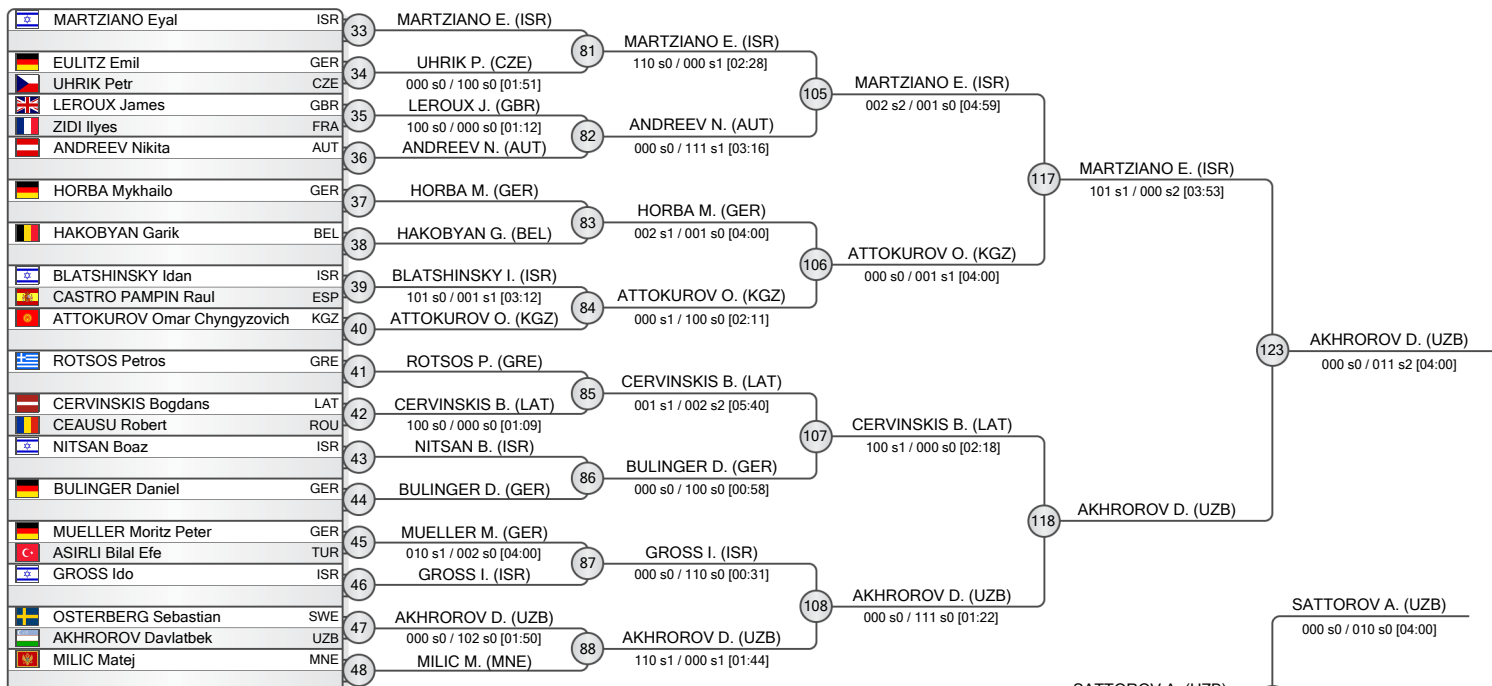

POOL D

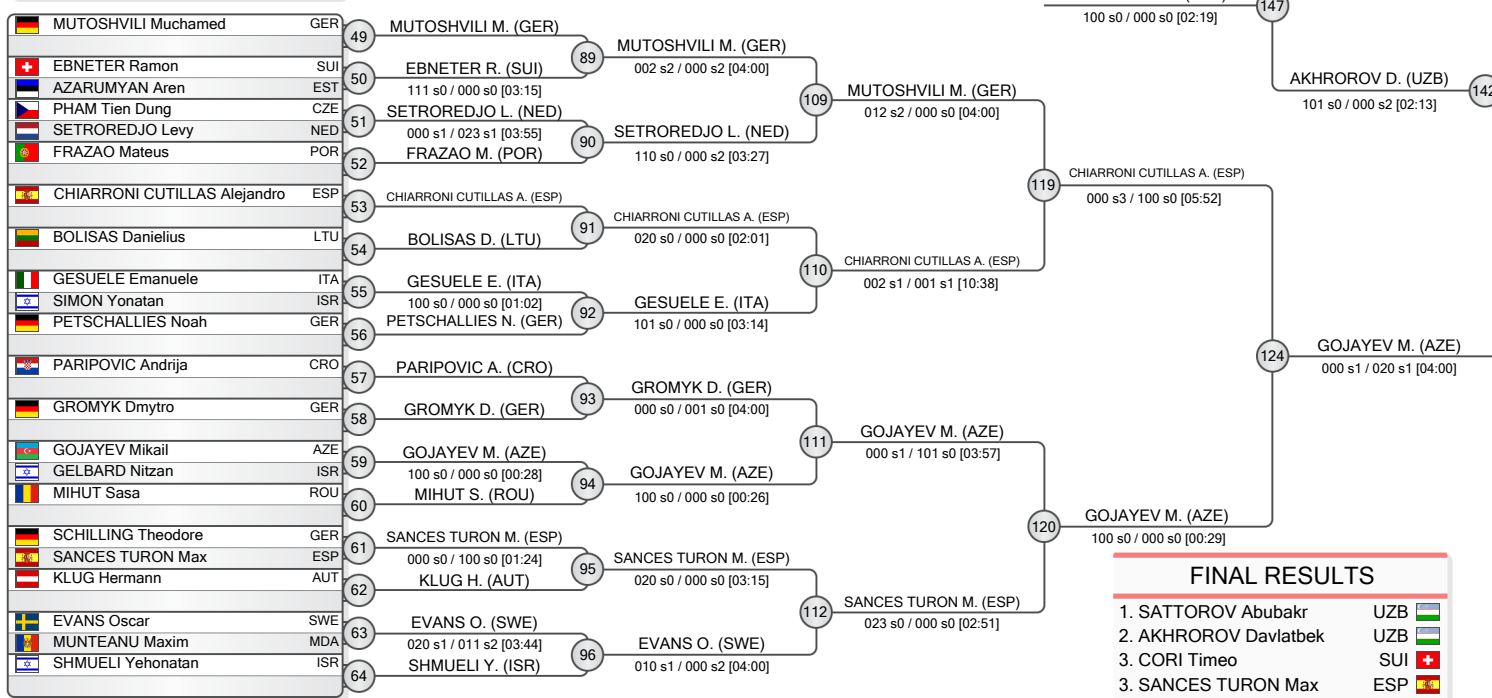

FINAL RESULTS

- SATTOROV Abubakr UZB
- AKHROROV Davlatbek UZB
- CORI Timeo SUI
- SANCES TURON Max ESP
- GOJAYEV Mikail AZE
- USINASHVILI Andro GEO
- ASGAROV Mehman AZE
- MARTZIANO Eyal ISR

REPECHAGE

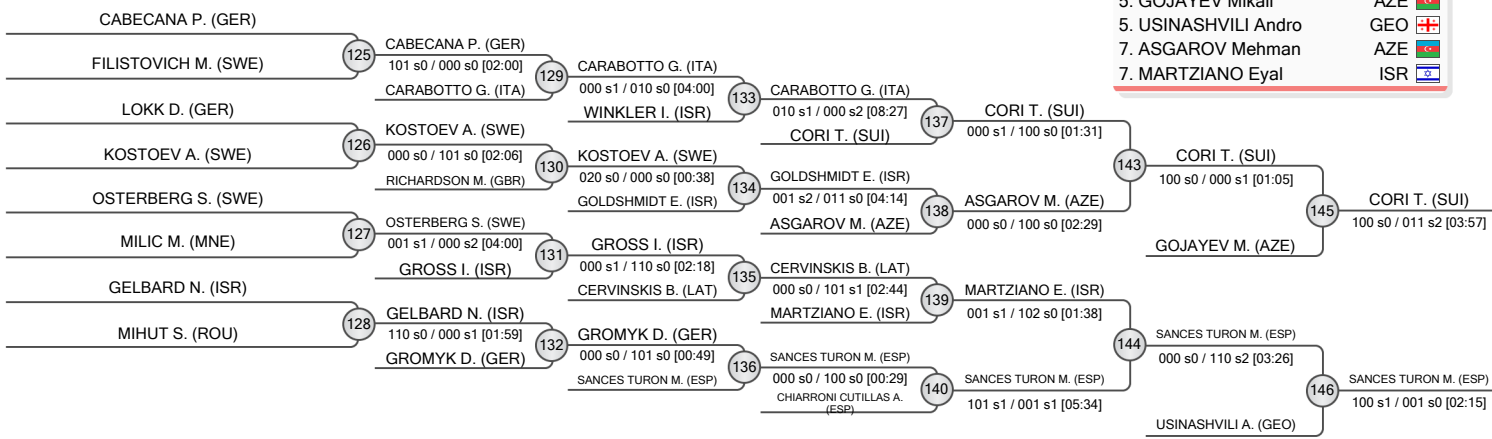



Berlin Millennium Team Cadet European Cup 2026

Germany, Berlin, 25-26 Apr 2026

-66 kg

Men (76)

POOL A

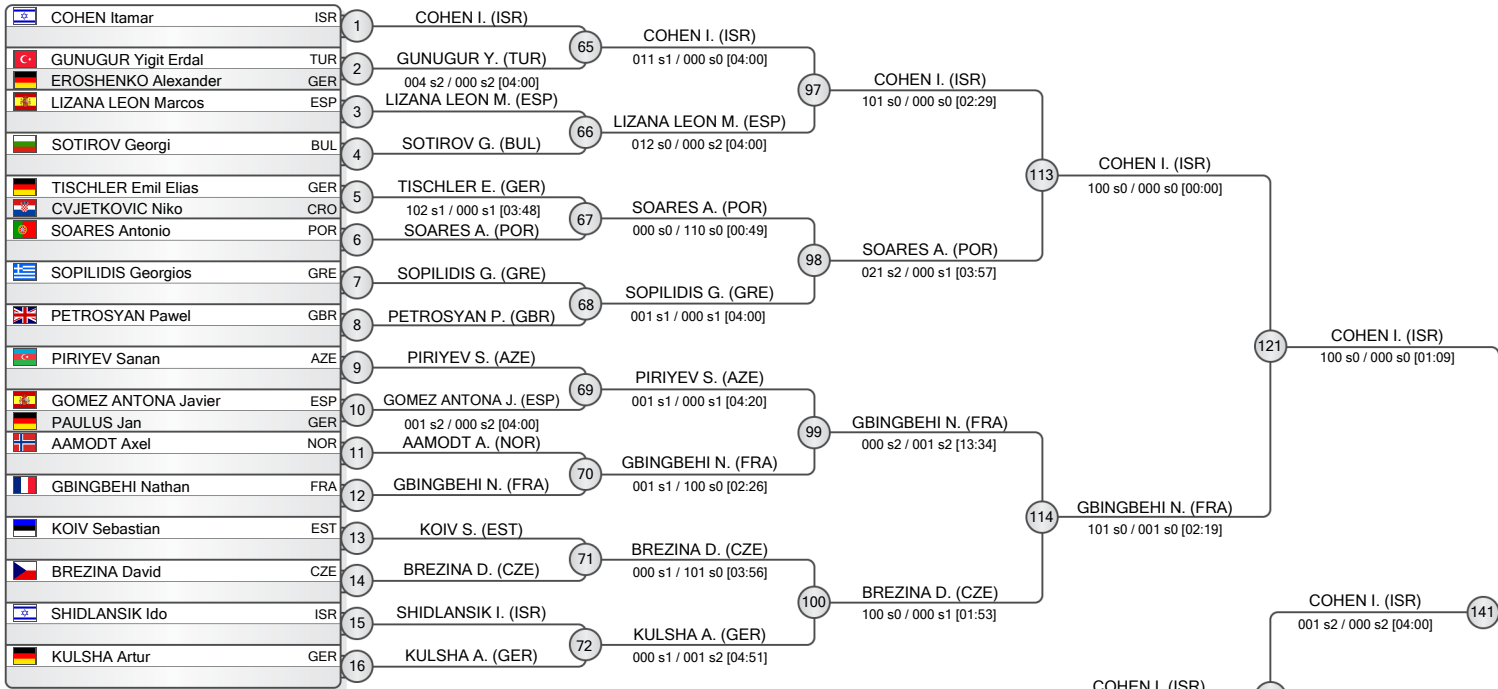

POOL B

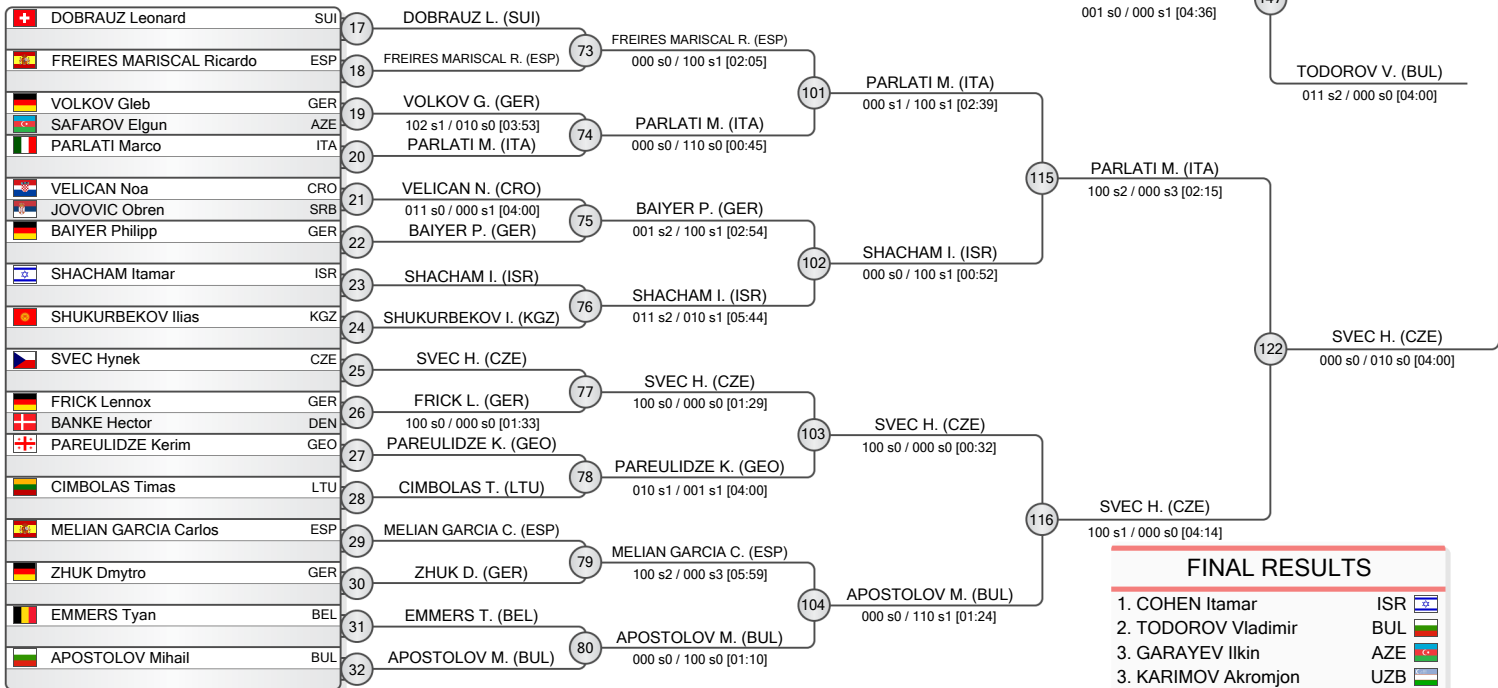

FINAL RESULTS	
1. COHEN Itamar	ISR
2. TODOROV Vladimir	BUL
3. GARAYEV Ilkin	AZE
3. KARIMOV Akromjon	UZB
5. PARLATI Marco	ITA
5. SVEC Hynek	CZE
7. GBINGBEHI Nathan	FRA
7. ATAMANIUK Rostyslav	GER

REPECHAGE

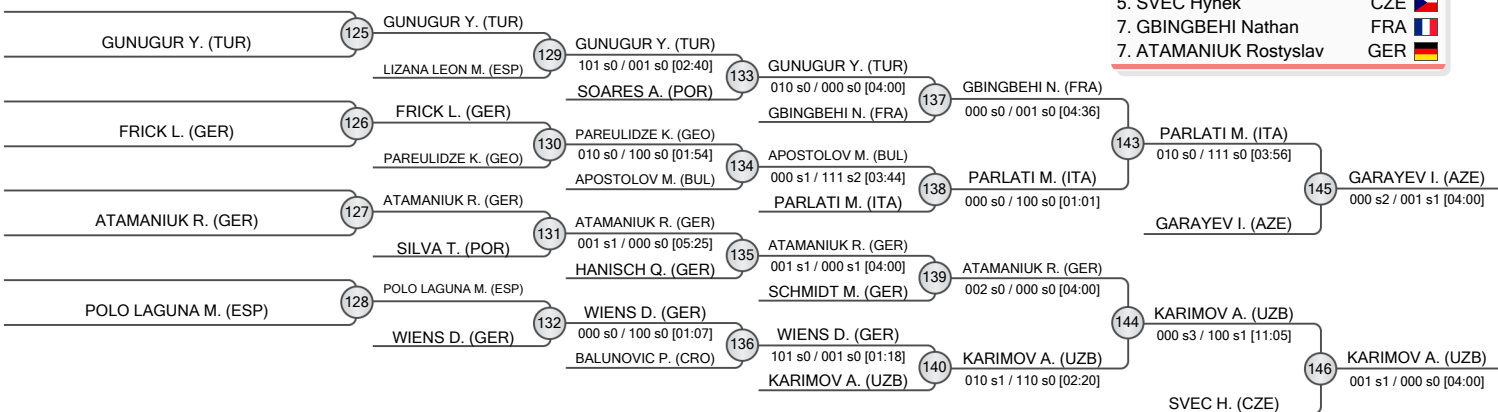



Berlin Millennium Team Cadet European Cup 2026

Germany, Berlin, 25-26 Apr 2026

-66 kg

Men (76)

POOL C

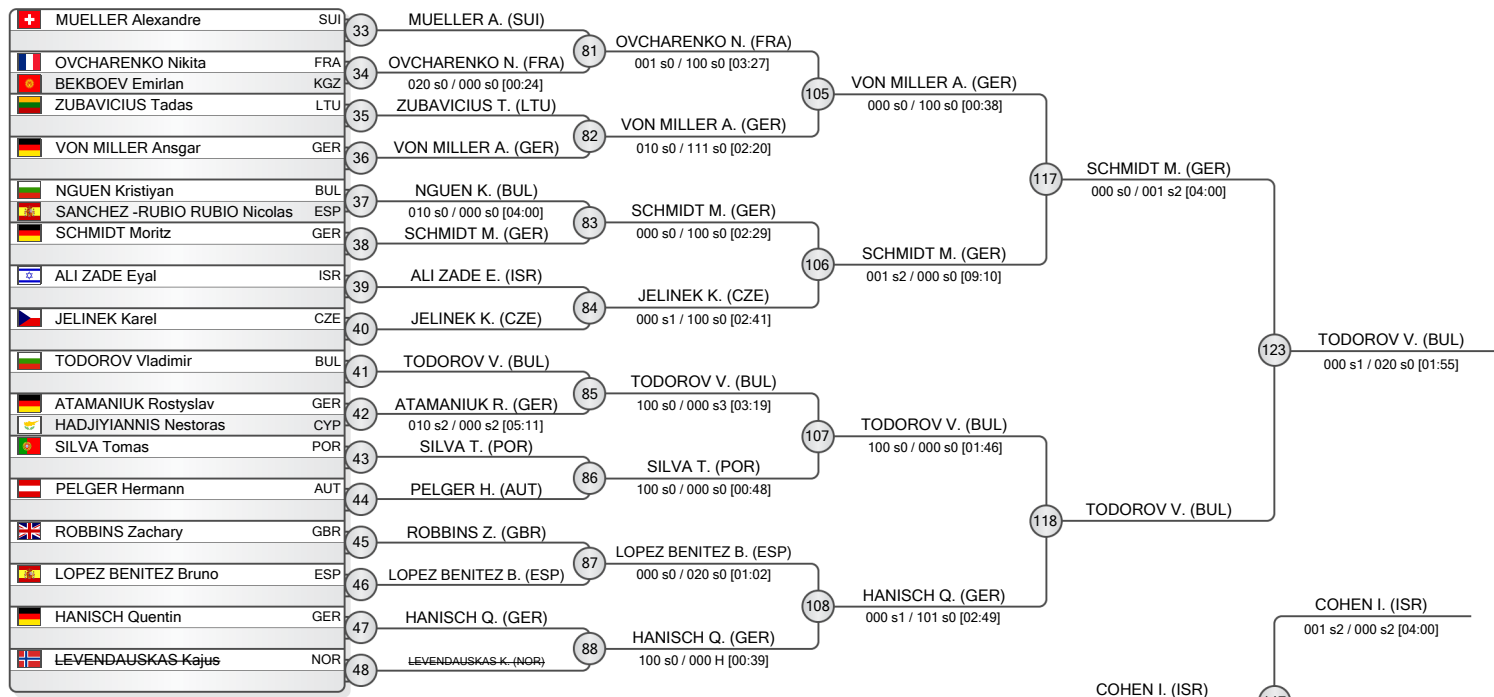

POOL D

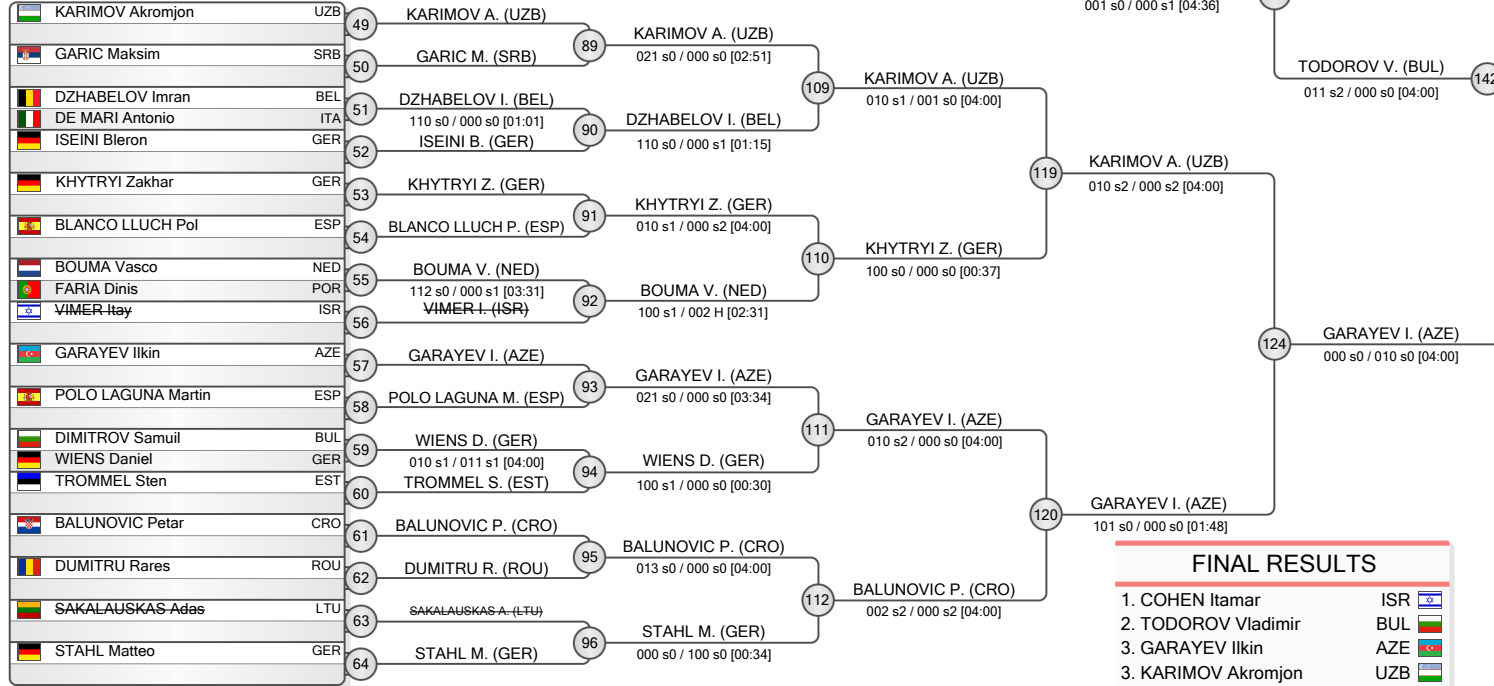

REPECHAGE

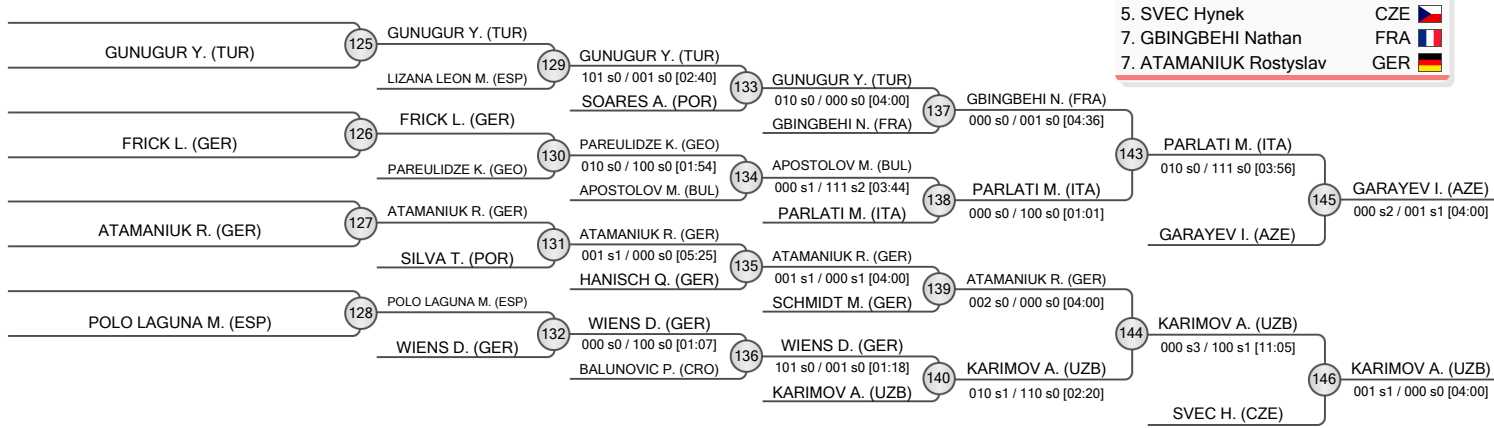

FINAL RESULTS		
1. COHEN Itamar	ISR	
2. TODOROV Vladimir	BUL	
3. GARAYEV Ilkin	AZE	
5. KARIMOV Akromjon	UZB	
5. PARLATI Marco	ITA	
5. SVEC Hynek	CZE	
7. GBINGBEHI Nathan	FRA	
7. ATAMANIUK Rostyslav	GER	





Berlin Millennium Team Cadet European Cup 2026

Germany, Berlin, 25-26 Apr 2026

-73 kg

Men (62)

POOL A

1	RUSNAK Adam (CZE)	1	RUSNAK A. (CZE)
2	KUTSON Kristjan (EST)	2	BOGAERT I. (BEL)
3	BOGAERT Ilkay (BEL)	3	MEYARA T. (ISR)
4	SCHERPING Maxim (GER)	4	REUTFORS V. (SWE)
5	MEYARA Tom (ISR)	5	MATUZNYI D. (GER)
6	REUTFORS Valter (SWE)	6	CECI E. (ITA)
7	KNEZEVIC Filip (MNE)	7	TOSCHPULOTOV D. (GER)
8	MATUZNYI Dmytro (GER)	8	MITOI S. (ROU)
9	HREN Adrian (CRO)	8	MARRERO TEJERA Yeremay (ESP)

POOL B

9	HRISTOFOROV Bruno (EST)	9	KILADZE L. (GER)
10	KILADZE Lazare (GER)	10	DOKOV K. (BUL)
11	DOKOV Kiril (BUL)	11	GILAD I. (ISR)
12	MARTON Medard (ROU)	12	HOVEN Max Theodor (NOR)
13	GILAD Itay (ISR)	13	NAZAR Y. (AZE)
14	SANTOS Samuel (POR)	14	KURTUMEROV Edem (GER)
15	PAUSKIC Silas (DEN)	15	KOKOEV KOKOEV Batraz (ESP)
16	HOVEN Max Theodor (NOR)	16	KURGHINYAN Misha (NED)
17	NAZAR Yusuf (AZE)	16	AGRONOV Idan (ISR)
18	KURTUMEROV Edem (GER)	16	EXMELIN Elyes (FRA)
19	KOKOEV KOKOEV Batraz (ESP)	16	MEDER-KURTOVIC Leon (AUT)
20	KURGHINYAN Misha (NED)	16	SCHUSTER Marek (GER)
21	AGRONOV Idan (ISR)		
22	EXMELIN Elyes (FRA)		
23	MEDER-KURTOVIC Leon (AUT)		
24	SCHUSTER Marek (GER)		

POOL C

17	NOGES Georg (EST)	17	NOGES G. (EST)
18	LENNON Cole (GBR)	18	SARZHANOV K. (KGZ)
19	SARZHANOV Kaisar (KGZ)	19	STOEGMANN S. (AUT)
20	STOEGMANN Stefan (AUT)	20	MOLIM Mayron (FRA)
21	MOLIM Mayron (FRA)	21	TSCHERHEIKO Mansur (GER)
22	TSCHERHEIKO Mansur (GER)	22	NISANOV Maxim (ISR)
23	NISANOV Maxim (ISR)	23	STINER Noam (ISR)
24	STINER Noam (ISR)	24	HANSCHMANN Juri (GER)
25	HANSCHMANN Juri (GER)	25	ZHELYAZKOV Dimitar (BUL)
26	ZHELYAZKOV Dimitar (BUL)	26	STEPINS Valters (LAT)
27	STEPINS Valters (LAT)	27	SLAVINSKAS Reinas (LTU)
28	SLAVINSKAS Reinas (LTU)	28	KUBITZA Maximilian (GER)
29	KUBITZA Maximilian (GER)	29	MAMMADOV Sadig (AZE)
30	MAMMADOV Sadig (AZE)	30	STARING Eros (NED)
31	STARING Eros (NED)		

POOL D

25	NIKOLCHEV Ivan (BUL)	25	NIKOLCHEV I. (BUL)
26	GOLOVKINS Denis (FRO)	26	ESSADE A. (SUI)
27	ESSADE Antoine (SUI)	27	POHLMANN Willi-Balduin (GER)
28	VULETIC Kevin (GER)	28	ALIKHANOV Amir (EST)
29	POHLMANN Willi-Balduin (GER)	29	MURESAN Erik (ROU)
30	ALIKHANOV Amir (EST)	30	MCALEESE Sean (GBR)
31	MURESAN Erik (ROU)	31	SCHUERER Hannes (GER)
32	MCALEESE Sean (GBR)	32	BARBALATA Mario Florin (ITA)
33	SCHUERER Hannes (GER)	32	USMONOV Bekhruzbeq (UZB)
34	BARBALATA Mario Florin (ITA)	32	VOJVODA Divo (CRO)
35	USMONOV Bekhruzbeq (UZB)	32	STANJA Jonathan (GER)
36	VOJVODA Divo (CRO)	32	RAHIMOV Kanan (AZE)
37	STANJA Jonathan (GER)	32	SANUDO SAMPERIO Dario (ESP)
38	RAHIMOV Kanan (AZE)	32	MOLOMAN Sagi (ISR)
39	SANUDO SAMPERIO Dario (ESP)		
40	MOLOMAN Sagi (ISR)		

REPECHAGE

61	HREN A. (CRO)	61	CECI E. (ITA)
62	CECI E. (ITA)	62	TOSCHPULOTOV D. (GER)
63	HRISTOFOROV B. (EST)	63	GILAD I. (ISR)
64	DOKOV K. (BUL)	64	STARING E. (NED)
65	STARING E. (NED)	65	STINER N. (ISR)
66	SLAVINSKAS R. (LTU)	66	SCHUERER H. (GER)
67	VOJVODA D. (CRO)	67	RAHIMOV K. (AZE)
68	SCHUERER H. (GER)	68	ESSADE A. (SUI)

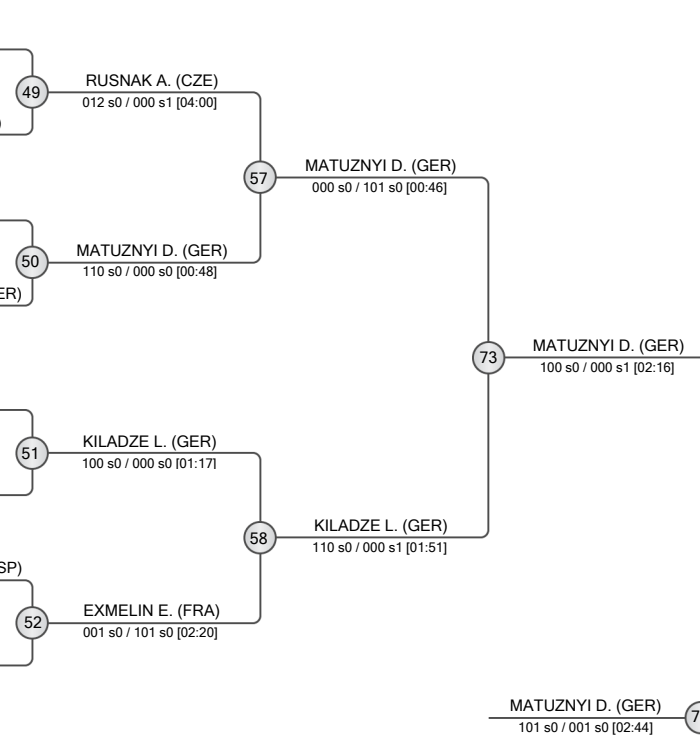

FINAL RESULTS	
1.	MATUZNYI Dmytro (GER)
2.	MAMMADOV Sadig (AZE)
3.	USMONOV Bekhruzbeq (UZB)
3.	STARING Eros (NED)
5.	HRISTOFOROV Bruno (EST)
5.	KILADZE Lazare (GER)
7.	CECI Emiliano (ITA)
7.	SCHUERER Hannes (GER)





Berlin Millennium Team Cadet European Cup 2026

Germany, Berlin, 25-26 Apr 2026

-81 kg

Men (59)

POOL A

	KIKAS Aleksei	EST
	SATOROVIC Emir	AUT
	WIESENBERGER Till Louis	GER
	HASANLI Aykhan	AZE
	VAN WOENSEL Ties	NED
	MADSEN Emil	DEN
	ADAMEC Maxmilian Tomas	CZE
	ROSENBERG Yoav	ISR
	NURTILEKOV Elgazy	KGZ
	BECK Flynt	GER
	PETRE David	ROU
	POPIVODA Vukan	MNE
	NUX Alexandre	FRA
	NURM August Martin	EST
	OSMANI Mensur	GER

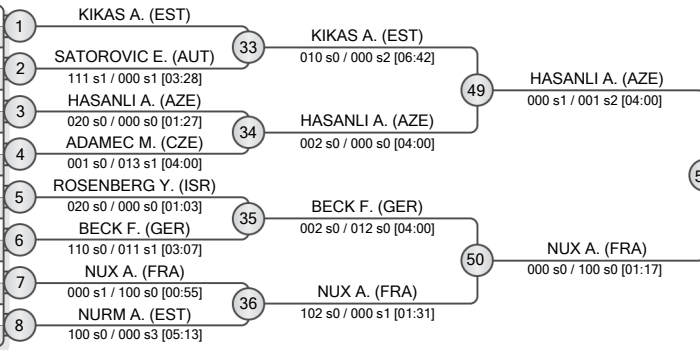

POOL B

	TOOMEL Joosep	EST
	MATTSSON Kalle	SWE
	KILADZE Giga	GER
	SILLAH Moise	GER
	KRMEK Roko Ivan	CRO
	PUGH Harvey	GBR
	SUPAKHUNOV David	LTU
	MAMMADOV Yagub	AZE
	KATSARSKI Teodor	BUL
	SCHWENKE Johann	GER
	GKOLIAS Efthymios	GRE
	HARCAVI Adam	ISR
	FENSKI Ole	GER
	SILLAR Richard	EST

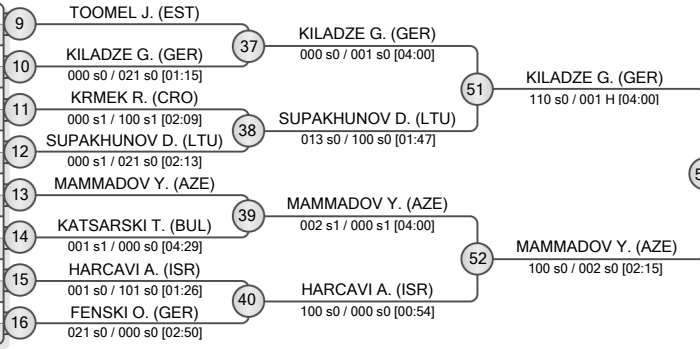

POOL C

	MEHDIYEV Amin	AZE
	MOOR Louis-Alexander	GER
	ERIKSON Mattias	EST
	ERLICH Roland	GER
	ISAKOV Baiel	KGZ
	IURCOVSCHI Daniel	FRA
	NAGY Akos	ROU
	HASANLI Polad	AZE
	AHRENS Jan Alexander	GER
	PODKUJKO Igors	LAT
	FARFELDER Samuel	AUT
	KOEVER Siim	EST
	DAVIDASHVILY Yakov	ISR
	FACHIRIDIS Stavros	GER
	SILVA Vicente	POR

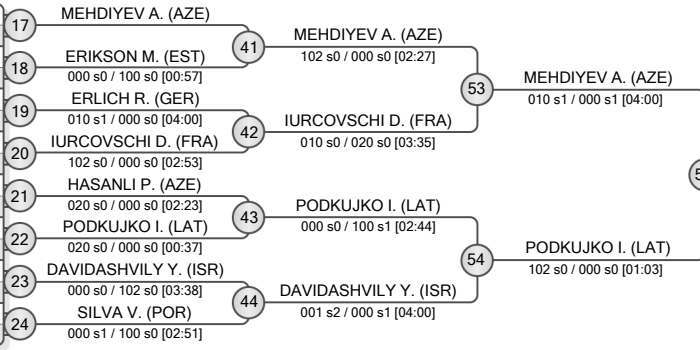

POOL D

	VALA Lukas	CZE
	VAN DER KROON Jan	NED
	UNTERBERG Lev	GER
	PONOMARENKO Ivan	GER
	MCGIVERN Aodhan	GBR
	MATHUES Sid	BEL
	CANEPARI Riccardo	ITA
	SUNNATOV Samandar	UZB
	SEIDELBERG Marten	EST
	DIMITROV Plamen	BUL
	MINICH Michail	GER
	KRZELJ Dante	CRO
	BEN SHITRIT Ehud	ISR
	KUNSZABO Matei	ROU
	KARAZELIDIS Pavlos	GER

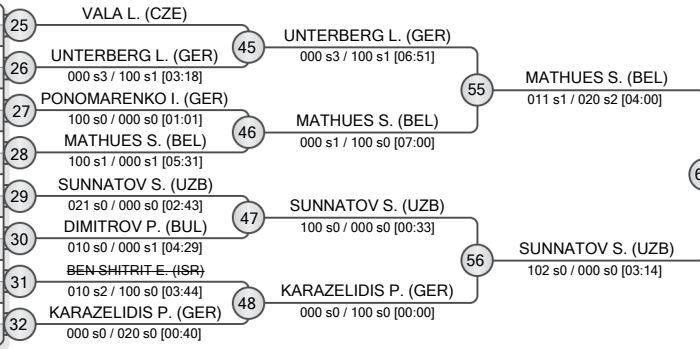

REPECHAGE

VAN WOENSEL T. (NED)	61	VAN WOENSEL T. (NED)	65
ADAMEC M. (CZE)	62	KIKAS A. (EST)	66
KATSARSKI T. (BUL)	63	HARCAVI A. (ISR)	67
ERIKSON M. (EST)	64	ERIKSON M. (EST)	68
SEIDELBERG M. (EST)		IURCOVSCHI D. (FRA)	
DIMITROV P. (BUL)		DIMITROV P. (BUL)	

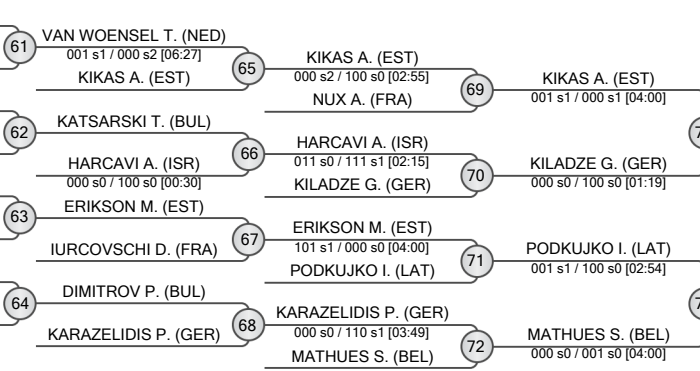

FINAL RESULTS		
1.	SUNNATOV Samandar	UZB
2.	HASANLI Aykhan	AZE
3.	MEHDIYEV Amin	AZE
4.	MAMMADOV Yagub	AZE
5.	KILADZE Giga	GER
6.	MATHUES Sid	BEL
7.	KIKAS Aleksei	EST
8.	PODKUJKO Igors	LAT





Berlin Millennium Team Cadet European Cup 2026

Germany, Berlin, 25-26 Apr 2026

-90 kg

Men (34)

POOL A

	BABAICENKO Tajus	LTU	1
	CLEDJO Mathys	BEL	2
	BEYELER Gabriel	SUI	3
	KHABIR Mehdi	FRA	4
	YRYSDOLOTOV Mukhammedali	KGZ	5
	NAUTA Jacob	NED	6
	GRAEBER Julian	GER	7
	SEBELKA Hugo	CZE	8

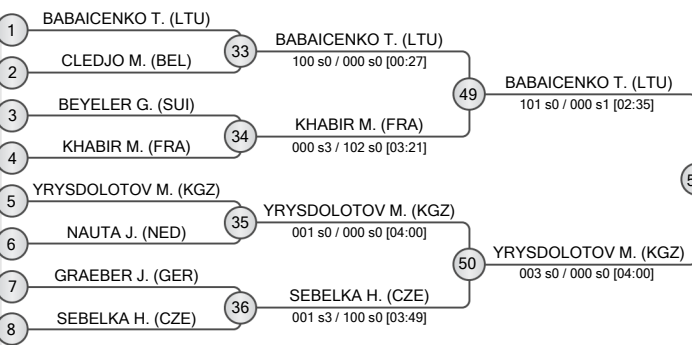

POOL B

	MARKOVIC Arian	CRO	9
	TRUUVERK Huud-Keerit	EST	10
	NIELSEN Holger	DEN	11
	SHNIDER Omer	ISR	12
	WOERMANSEDER Johannes	AUT	12
	KOLOSOVS Dmitrijs	LAT	13
	SEGUIN RENDAL Ian	ESP	14
	ALIYEV Nuraddin	AZE	15
	AL-HASSANI Saged	GER	16

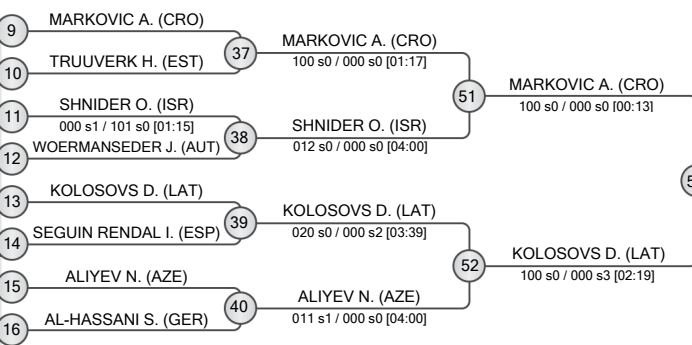

POOL C

	ESHPULATOV Jurabek	UZB	17
	LEETSAR Kaur	EST	18
	KONOPLYANYK Nikolai	BEL	19
	EMILOV Bobi	BUL	20
	SIGNORINI Nicolo	ITA	21
	VRABETZ Alexander	AUT	22
	BOOMKAMP Marinus	NED	22
	ALBRECHT Anton	GER	23
	SIDLAUSKAS Jokubas	LTU	24

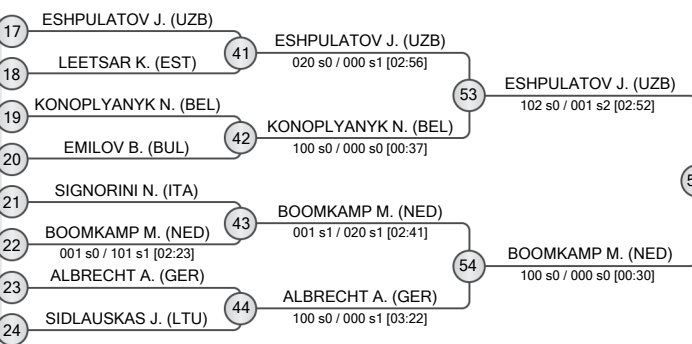

POOL D

	SCHEIBER Felix	AUT	25
	AKHUNDOV Omar	AZE	26
	KISSK Julian Henryk	GER	27
	AMACIN Marlene	FRA	28
	GOLTZ Jerome	GER	29
	FERNANDEZ CALERO Pablo	ESP	30
	GARAGAU Razvan	ROU	31
	LAJCAK Ondrej	CZE	32

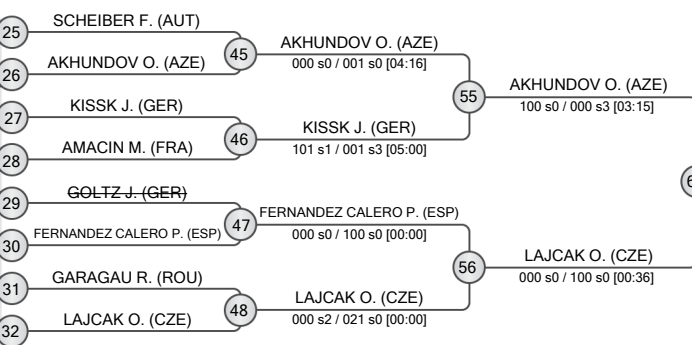

REPECHAGE

61	CLEDJO M. (BEL)	65	CLEDJO M. (BEL)	69	YRYSDOLOTOV M. (KGZ)
62	SEGUIN RENDAL I. (ESP)	66	ALIYEV N. (AZE)	70	ALIYEV N. (AZE)
63	LEETSAR K. (EST)	67	LEETSAR K. (EST)	71	BOOMKAMP M. (NED)
64	SCHEIBER F. (AUT)	68	SCHEIBER F. (AUT)	72	SCHEIBER F. (AUT)

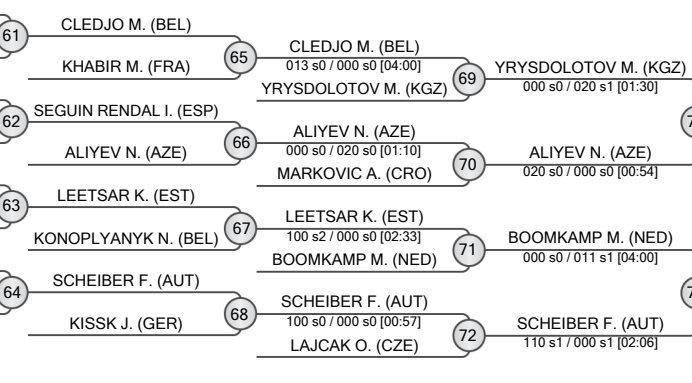

FINAL RESULTS		
1.	BABAICENKO Tajus	LTU
2.	AKHUNDOV Omar	AZE
3.	YRYSDOLOTOV Mukhammedali	KGZ
3.	SCHEIBER Felix	AUT
5.	ESHPULATOV Jurabek	UZB
5.	KOLOSOVS Dmitrijs	LAT
7.	ALIYEV Nuraddin	AZE
7.	BOOMKAMP Marinus	NED





Berlin Millennium Team Cadet European Cup 2026

Germany, Berlin, 25-26 Apr 2026

+ 90 kg

Men (20)

POOL A

	SKODA Melichar	CZE
	KIASUMBUA Eilijah	FRA
	IKMAN Den	ISR
	TEGELAAR Jack	SWE
	THAMM Max Anton	GER

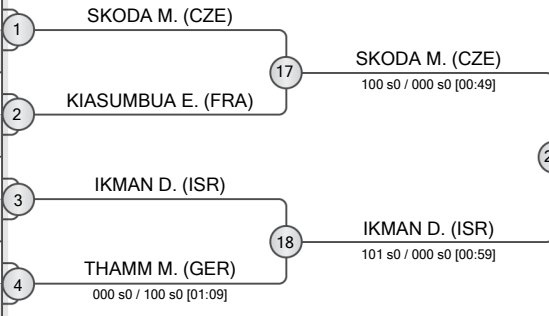

POOL B

	TOLIBAEV Ersultan	UZB
	SOM Samuel	FRA
	LOBATO PEREZ Aimar	ESP
	BADEA Petru	ROU
	BRUINING Joshua	NED

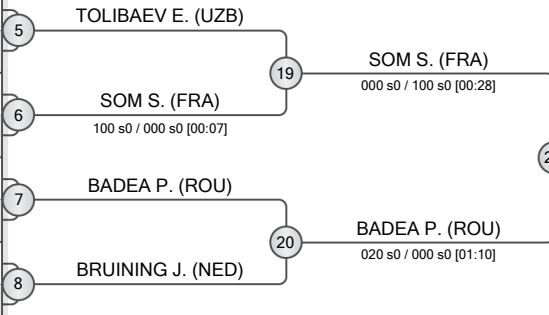

POOL C

	APSALONS Aleksandrs	LAT
	LODDES Romet	EST
	BRUNNER Jan	CZE
	RIETDIJK Keano	NED
	STETTINSKY Lucas	GER

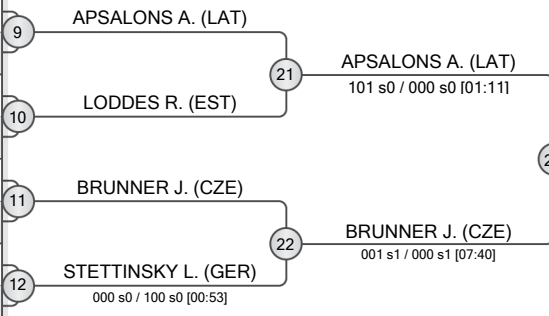

POOL D

	ALIYEV Tamerlan	AZE
	SAURA Nathan	FRA
	BRAUSEWETTER Maarten	GER
	KAZIMOV Ruslan	AZE
	BOLOTBEKOV Altynbek	KGZ

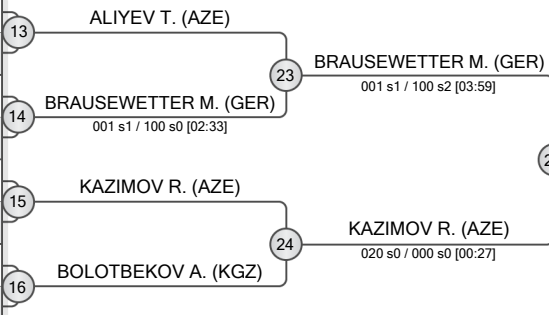

REPECHAGE

29	KIASUMBUA E. (FRA)
30	BRUINING J. (NED)
31	LODDES R. (EST)
32	BOLOTBEKOV A. (KGZ)

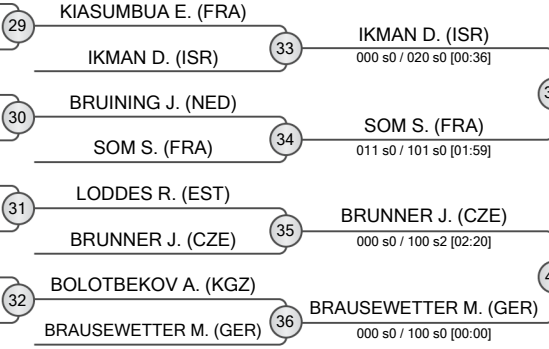

FINAL RESULTS	
1.	SKODA Melichar CZE
2.	APSALONS Aleksandrs LAT
3.	KAZIMOV Ruslan AZE
3.	BADEA Petru ROU
5.	SOM Samuel FRA
7.	BRUNNER Jan CZE
7.	IKMAN Den ISR
7.	BRAUSEWETTER Maarten GER





Berlin Millennium Team Cadet European Cup 2026

Germany, Berlin, 25-26 Apr 2026

-40 kg

Women (16)

POOL A

	GRACOVA Dominika	CZE
	BARRAY Jade	FRA
	BREM Nawaii	NED
	CRACIUN Ana Maria	ROU

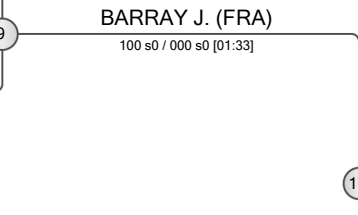
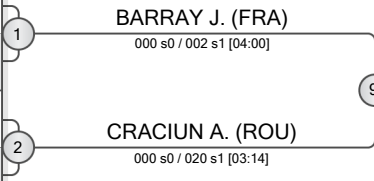

POOL B

	KARAKAZAN Elcin	TUR
	EMMERLING Greta	GER
	SIROJIDDINOVA Iroda	UZB
	GULIYEVA Zahra	AZE

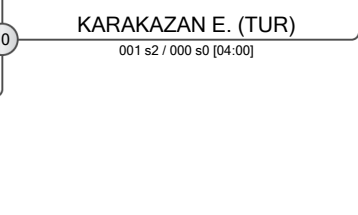
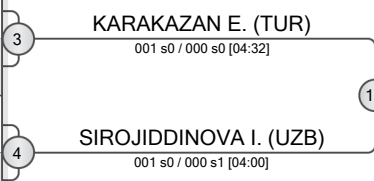

POOL C

	TOKMAK Havva Sena	TUR
	MOUSSATI Assia	FRA
	SALAMOVA Sunay	AZE
	PHAM Serra	NED

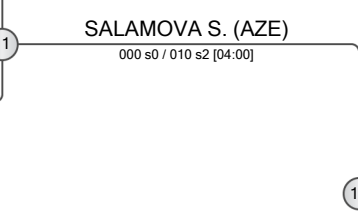
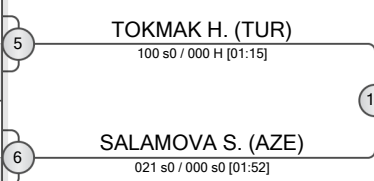

POOL D

	GAT MUALEM Avigayil	ISR
	BALANEAN Stefania	ROU
	COSTA CABANA Candela	ESP
	SCHEIDA Julia	GER

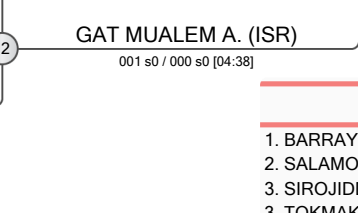
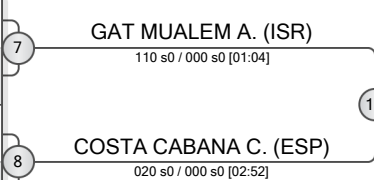

REPECHAGE

GRACOVA D. (CZE)	13
CRACIUN A. (ROU)	14
EMMERLING G. (GER)	15
SIROJIDDINOVA I. (UZB)	16
PHAM S. (NED)	17
TOKMAK H. (TUR)	18
BALANEAN S. (ROU)	19
COSTA CABANA C. (ESP)	20

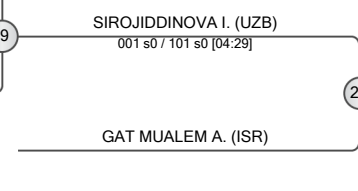
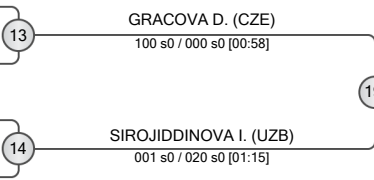

FINAL RESULTS		
1.	BARRAY Jade	FRA
2.	SALAMOVA Sunay	AZE
3.	SIROJIDDINOVA Iroda	UZB
3.	TOKMAK Havva Sena	TUR
5.	GAT MUALEM Avigayil	ISR
5.	KARAKAZAN Elcin	TUR
7.	GRACOVA Dominika	CZE
7.	COSTA CABANA Candela	ESP





Berlin Millennium Team Cadet European Cup 2026

Germany, Berlin, 25-26 Apr 2026

-44 kg

Women (31)

POOL A

	LONGO Sofia	ITA
	MICHI Vivian Marie	GER
	HEYDARZADE Nigar	AZE
	DAVIS Katrina	GBR
	BROUNEN Fem	NED
	BIRINCI Hiranur	TUR
	SOFFER Lihi	ISR

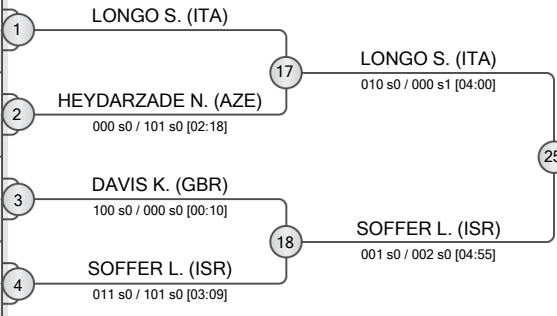

POOL B

	CONI Sara	ITA
	LUDVIG Amalia	ROU
	SOUBIELLE Maia	FRA
	SAMARDZHIDI Anna	AUT
	PEETERS Fenne	BEL
	KOLUCHEVA Alina	UZB
	MONZO PASCUAL Marta	ESP
	STEPANOVA Anastasiia	KGZ

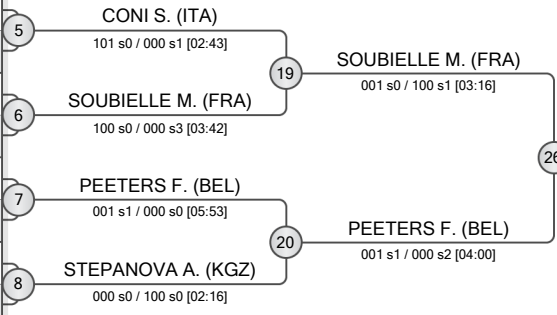

POOL C

	YILMAZTURK Yagmur	TUR
	ITSKOV Rivka	ISR
	HISSETTE Nell	BEL
	KILACKOVA Silvia	SVK
	ABDULLAYEVA Fatima	AZE
	MARIAN Daria	ROU
	BOLTABOEVA Dilafuz	UZB
	GRAVENSTIJN Tracey	NED

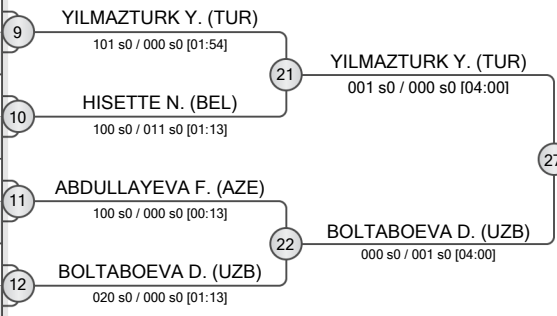

POOL D

	MANASBEKOVA Munira	KGZ
	VALVERDE DURAN Claudia	ESP
	SEVKHANLI Parvin	AZE
	SAMARDZHIDI Maria	AUT
	CIUMAS Bianca	ROU
	DEEB Leia	GER
	SURDEZ KAUL Zelie	FRA
	OSTERBERG Josephine	SWE

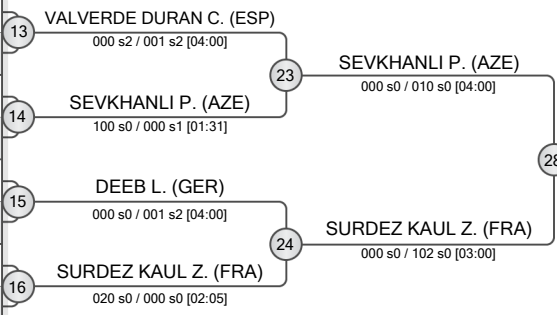

REPECHAGE

HEYDARZADE N. (AZE)	29	HEYDARZADE N. (AZE)
SAMARDZHIDI A. (AUT)	30	CONI S. (ITA)
CONI S. (ITA)	30	PEETERS F. (BEL)
ITSKOV R. (ISR)	31	HISSETTE N. (BEL)
HISSETTE N. (BEL)	31	BOLTABOEVA D. (UZB)
SAMARDZHIDI M. (AUT)	32	VALVERDE DURAN C. (ESP)
VALVERDE DURAN C. (ESP)	32	SURDEZ KAUL Z. (FRA)

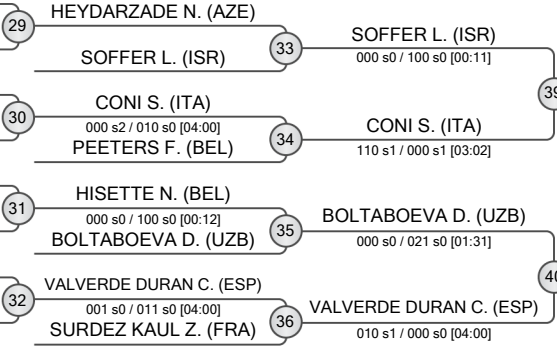

FINAL RESULTS	
1.	YILMAZTURK Yagmur
2.	LONGO Sofia
3.	SEVKHANLI Parvin
3.	BOLTABOEVA Dilafuz
5.	CONI Sara
7.	SOUBIELLE Maia
7.	SOFFER Lihi
7.	VALVERDE DURAN Claudia





Berlin Millennium Team Cadet European Cup 2026

Germany, Berlin, 25-26 Apr 2026

-48 kg

Women (37)

POOL A

ISR	NOY Agam Sol	1
NED	NIJHUIS Jelena	2
AZE	ZEYNALOVA Sakina	3
GBR	DOE Betsy	4
POR	CARVALHO Mariana	5
TUR	COSKUN Busra Ceylin	6
AUT	KUNYIK Laura-Sophie	7
BEL	MARTINEZ Navia	8
GER	BRUNETT Hanna	9

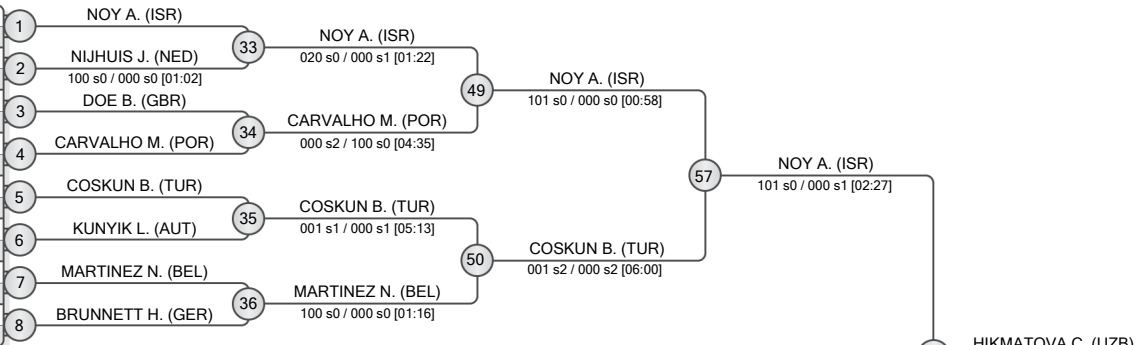

POOL B

UZB	HIKMATOVA Charos	9
GER	KRATZER Helene	10
FRA	STEFANIE Mamitantly Oceana	11
ROU	ROGOJINARU Adelina	12
ISR	BIRGER Ella	13
ITA	STORIONE Ludovica	14
POR	SOARES Maria	15
ESP	SANTIN MORENO Miriam	16
SWE	WIJK Alma	17
SRB	GORANOVIC Katarina	18

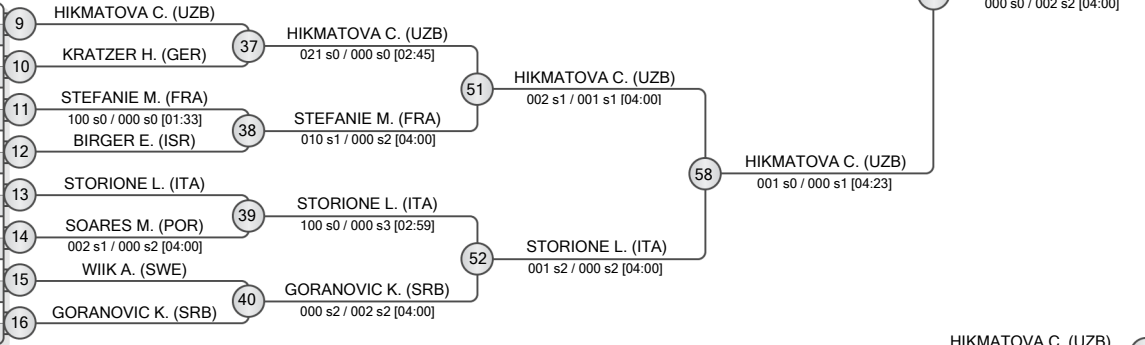

POOL C

ISR	STARK Leeyam	17
GER	KOEPPEN Jane	18
SWE	WAHLSTROM Selma	19
BEL	GRIGORYAN Viktoria	20
GER	BEERMANN Mia Marie	21
DEN	FONSBOEL Elena	22
ESP	REMIGIO RUIZ Nadia	23
GBR	BUCHANAN Alexis	24
LTU	VALKAUSKAITE Vismante	25

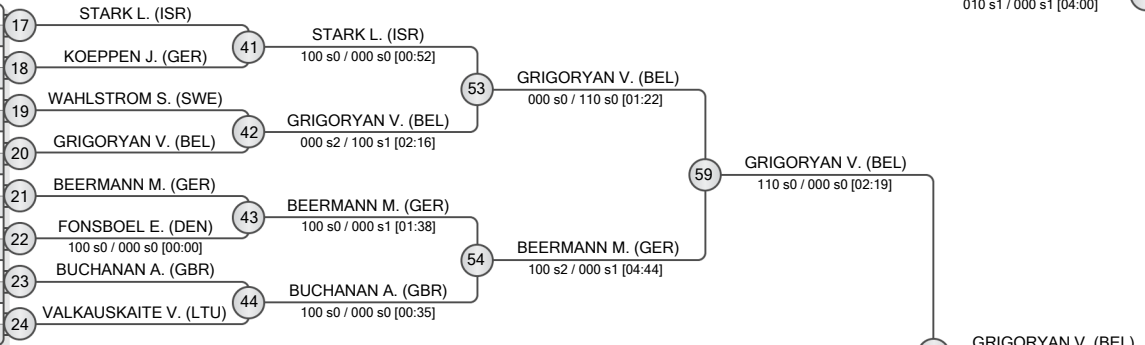

POOL D

AZE	EYVAZLI Konul	25
AUT	MANTAEVA Jasmina	26
ESP	BELTRAN MARUENDA Ivet	27
FRA	TIXIER Line	28
POR	FRANCO Carolina	29
EST	AZARUMYAN Anna	30
SWE	FALDT Lova	31
GER	STEINBERG Michelle	32
CRO	KATUSIC Nika	33

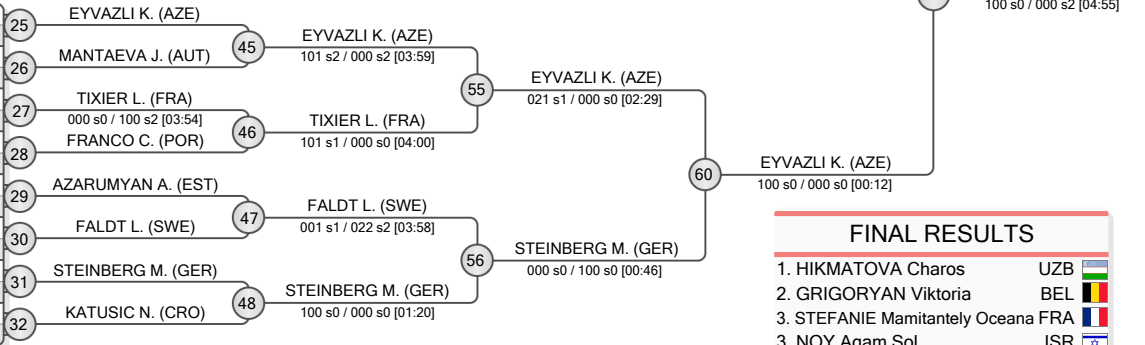

FINAL RESULTS		
1.	HIKMATOVA Charos	UZB
2.	GRIGORYAN Viktoria	BEL
3.	STEFANIE Mamitantly Oceana	FRA
3.	NOY Agam Sol	ISR
5.	EYVAZLI Konul	AZE
5.	BEERMANN Mia Marie	GER
7.	NIJHUIS Jelena	NED
7.	MANTAEVA Jasmina	AUT

REPECHAGE

61	NIJHUIS J. (NED)
62	KRATZER H. (GER)
63	WAHLSTROM S. (SWE)
64	MANTAEVA J. (AUT)

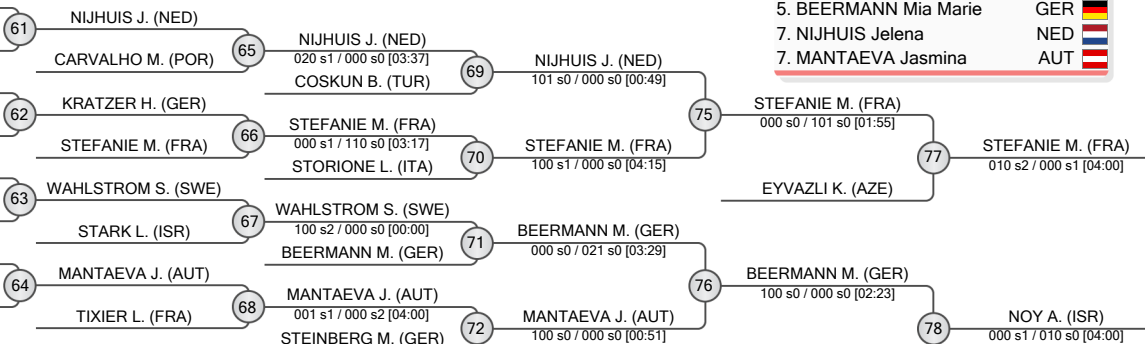



Berlin Millennium Team Cadet European Cup 2026

Germany, Berlin, 25-26 Apr 2026

-52 kg

Women (45)

POOL A

CHIRON Alexandra	MDA
KRZYZANIAK Zoe	GER
MARTIN TORRES Jimena	ESP
AKERSTROM Thelma	SWE
GUION Sofia	ITA
GOECKERITZ Leni	GER
SOUSA LAVANDEIRA Zeltia	ESP
WELLEKENS Amelie	BEL
KING Hannah	GBR
GUPALO Liana	GER
DOUMBIA Salma	FRA

1	CHIRON A. (MDA)	33	CHIRON A. (MDA)	
2	MARTIN TORRES J. (ESP)	000 s0 / 111 s0 [03:42]	021 s1 / 000 s1 [03:51]	
3	GUION S. (ITA)	000 s0 / 101 s0 [01:26]	34	GUION S. (ITA)
4	GOECKERITZ L. (GER)	100 s0 / 000 s0 [00:56]	49	CHIRON A. (MDA)
5	SOUSA LAVANDEIRA Z. (ESP)		57	CHIRON A. (MDA)
6	WELLEKENS A. (BEL)	35	WELLEKENS A. (BEL)	
7	GUPALO L. (GER)	000 s0 / 100 s0 [01:25]	50	WELLEKENS A. (BEL)
8	DOUMBIA S. (FRA)	000 s1 / 101 s0 [01:30]	36	DOUMBIA S. (FRA)

57	CHIRON A. (MDA)	100 s0 / 000 s0 [03:32]
50	WELLEKENS A. (BEL)	010 s2 / 000 s0 [04:00]
73	CHIRON A. (MDA)	110 s0 / 000 s0 [00:59]

POOL B

TUERK Helin	AUT
BUZINA Anastasia	EST
PETERSON Elsa	SWE
REITMANN Anna	GER
WOLSTER Gili Racheli	ISR
BROADLEY Maisie	GBR
AGHAMIRZAZADE Narmin	AZE
GERINGER Xenia	GER
TERES CEREZA Daniela	ESP
VAN DE RIJZEN Lieve	NED
WOERNER Daphne	GER

9	TUERK H. (AUT)	37	TUERK H. (AUT)	
10	PETERSON E. (SWE)	000 s2 / 101 s1 [04:00]	51	TUERK H. (AUT)
11	REITMANN A. (GER)	100 s0 / 000 s0 [01:50]	38	REITMANN A. (GER)
12	BROADLEY M. (GBR)	100 s1 / 000 s1 [03:56]	58	AGHAMIRZAZADE N. (AZE)
13	AGHAMIRZAZADE N. (AZE)		52	AGHAMIRZAZADE N. (AZE)
14	GERINGER X. (GER)	39	AGHAMIRZAZADE N. (AZE)	
15	VAN DE RIJZEN L. (NED)	000 s1 / 010 s0 [04:00]	40	VAN DE RIJZEN L. (NED)
16	WOERNER D. (GER)	100 s0 / 000 s1 [03:57]		

51	TUERK H. (AUT)	020 s1 / 002 s0 [02:47]
58	AGHAMIRZAZADE N. (AZE)	000 s0 / 112 s0 [01:55]
52	AGHAMIRZAZADE N. (AZE)	010 s1 / 000 s0 [04:56]

POOL C

YAHAV Yali	ISR
BABAYEVA Tovsiyya	AZE
LAMM Valentina	AUT
MANTYKENTTA Sara	FIN
LARSEN Ria	SUI
KUKIC Lana	GER
BOSKUP Aysenur	TUR
TSIONARAS Dora Eleana	GER
HELGESSON Emilia	SWE
VAINER Xenia	MDA
LOPEZ GORDO Sofia	ESP
JAEGER Sophie	GER

17	YAHAV Y. (ISR)	41	YAHAV Y. (ISR)	
18	BABAYEVA T. (AZE)	011 s1 / 000 s1 [04:00]	53	YAHAV Y. (ISR)
19	LARSEN R. (SUI)	000 s1 / 010 s0 [04:00]	42	KUKIC L. (GER)
20	KUKIC L. (GER)	000 s0 / 100 s0 [00:55]	59	BOSKUP A. (TUR)
21	BOSKUP A. (TUR)		54	BOSKUP A. (TUR)
22	HELGESSON E. (SWE)	000 s0 / 020 s0 [01:31]	43	BOSKUP A. (TUR)
23	LOPEZ GORDO S. (ESP)	000 s0 / 100 s0 [00:20]	44	LOPEZ GORDO S. (ESP)
24	JAEGER S. (GER)	110 s1 / 000 s2 [02:20]		

53	YAHAV Y. (ISR)	021 s0 / 000 s2 [03:18]
59	BOSKUP A. (TUR)	000 s1 / 101 s0 [03:56]
54	BOSKUP A. (TUR)	100 s0 / 000 s0 [00:47]
74	VUKASOVIC T. (SRB)	000 s0 / 010 s1 [04:00]

POOL D

VUKASOVIC Teodora	SRB
WEGELER Babette	GER
GRUBER Michelle	GER
CUSA Carla	ROU
PAUS Roni	ISR
FINDRIK Paula	CRO
DUBOSQ Ambre	FRA
ROMERA BARRAGAN Aniana	ESP
CEDERVALL CLAESSION Tilde	SWE
DALY Lucy	GBR
FOERSTER Mia	GER

25	VUKASOVIC T. (SRB)	45	VUKASOVIC T. (SRB)	
26	WEGELER B. (GER)	011 s0 / 000 s0 [04:00]	55	VUKASOVIC T. (SRB)
27	GRUBER M. (GER)	001 s1 / 000 s0 [04:00]	46	PAUS R. (ISR)
28	PAUS R. (ISR)	000 s1 / 102 s2 [03:47]	56	FINDRIK P. (CRO)
29	FINDRIK P. (CRO)		47	FINDRIK P. (CRO)
30	DUBOSQ A. (FRA)	100 s0 / 000 s1 [00:30]	48	FOERSTER M. (GER)
31	CEDERVALL CLAESSION T. (SWE)	101 s0 / 000 s0 [01:56]		
32	FOERSTER M. (GER)	000 s0 / 100 s0 [01:52]		

55	VUKASOVIC T. (SRB)	101 s0 / 000 s0 [03:39]
60	VUKASOVIC T. (SRB)	101 s0 / 000 s0 [00:49]
56	FINDRIK P. (CRO)	010 s1 / 000 s2 [04:39]

FINAL RESULTS		
1.	CHIRON Alexandra	MDA
2.	VUKASOVIC Teodora	SRB
3.	BOSKUP Aysenur	TUR
3.	AGHAMIRZAZADE Narmin	AZE
5.	VAN DE RIJZEN Lieve	NED
5.	YAHAV Yali	ISR
7.	WELLEKENS Amelie	BEL
7.	FINDRIK Paula	CRO

REPECHAGE

61	MARTIN TORRES J. (ESP)	65	GUION S. (ITA)
62	GERINGER X. (GER)	66	VAN DE RIJZEN L. (NED)
63	HELGESSON E. (SWE)	67	LOPEZ GORDO S. (ESP)
64	WEGELER B. (GER)	68	PAUS R. (ISR)

65	GUION S. (ITA)	69	WELLEKENS A. (BEL)
66	VAN DE RIJZEN L. (NED)	70	VAN DE RIJZEN L. (NED)
67	LOPEZ GORDO S. (ESP)	71	YAHAV Y. (ISR)
68	PAUS R. (ISR)	72	FINDRIK P. (CRO)

69	WELLEKENS A. (BEL)	75	VAN DE RIJZEN L. (NED)
70	VAN DE RIJZEN L. (NED)	76	YAHAV Y. (ISR)
71	YAHAV Y. (ISR)	77	BOSKUP A. (TUR)
72	FINDRIK P. (CRO)	78	AGHAMIRZAZADE N. (AZE)





Berlin Millennium Team Cadet European Cup 2026

Germany, Berlin, 25-26 Apr 2026

-57 kg

Women (58)

POOL A

	KILIC Elif	TUR
	BOUVIL Clarisse	FRA
	VAN BAAL Sijmmie	NED
	EVERS Josephine	GER
	NATARIO Maria	POR
	YUSIFLI Samaya	AZE
	VENDRELL JUAN Alexia	ESP
	SHATTOCK Maisie	GBR
	BAECHLE Sophia	GER
	JANSEN Marie-Lise	BEL
	MELAMED Lee	ISR
	ALIMOVA Zuhra	UZB
	BLANK Emilia	GER
	KILDEEVA Daria	FIN
	BORUBOLOTOVA Milena	KGZ

1	KILIC E. (TUR)	33	KILIC E. (TUR)		
2	VAN BAAL S. (NED)	000 s0 / 002 s0 [04:00]	010 s1 / 000 s0 [04:00]		
3	EVERS J. (GER)	100 s0 / 010 s0 [02:00]	34	YUSIFLI S. (AZE)	000 s0 / 102 s0 [02:33]
4	YUSIFLI S. (AZE)	002 s0 / 000 s0 [04:00]	35	BAECHLE S. (GER)	101 s0 / 000 s0 [01:23]
5	BAECHLE S. (GER)	000 s0 / 001 s0 [04:00]	36	ALIMOVA Z. (UZB)	100 s0 / 000 s0 [00:00]
6	JANSEN M. (BEL)	002 s0 / 000 s0 [04:00]	37	KILDEEVA D. (FIN)	100 s0 / 000 s0 [00:27]
7	ALIMOVA Z. (UZB)	000 s0 / 020 s0 [01:20]	38	CEPELAKOVA L. (CZE)	001 s1 / 000 s2 [04:20]
8	KILDEEVA D. (FIN)	020 s0 / 000 s1 [03:44]	39	PULJIC L. (CRO)	101 s1 / 000 s2 [04:00]

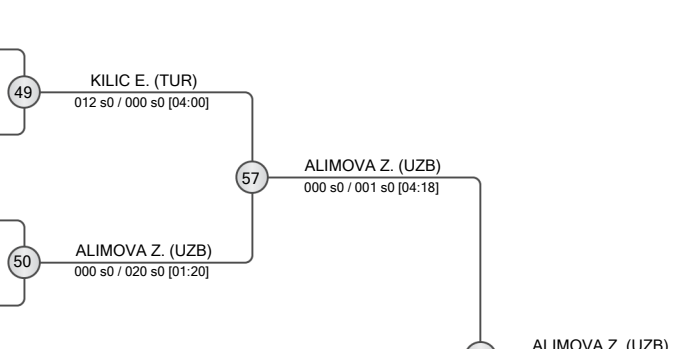

POOL B

	CEPELAKOVA Lucie	CZE
	PORCARI Miryam	ITA
	BACKLUND Nova	SWE
	NEUMANN Raphael	ISR
	STOEGMANN Isabella	AUT
	PETIDENT Ambre	FRA
	DRESSLER Lotta	GER
	PULJIC Lucija	CRO
	CHRISP Taylor	GBR
	BRAZINSKAITE Ieva	LTU
	ALONSO FERNANDEZ Sara	ESP
	RUSU Maria	MDA
	KRONENTHAL Charlotte	GER
	VALIZADA Sama	AZE

9	CEPELAKOVA L. (CZE)	37	CEPELAKOVA L. (CZE)		
10	PORCARI M. (ITA)	101 s0 / 000 s0 [01:26]	38	PETIDENT A. (FRA)	000 s0 / 100 s2 [03:50]
11	NEUMANN R. (ISR)	001 s1 / 000 s1 [04:00]	39	PULJIC L. (CRO)	101 s1 / 000 s2 [04:00]
12	PETIDENT A. (FRA)	101 s0 / 000 s1 [02:10]	40	KRONENTHAL C. (GER)	000 s0 / 100 s1 [02:09]
13	PULJIC L. (CRO)	000 s0 / 010 s1 [04:00]	41	KHAZRATOVA G. (UZB)	011 s0 / 000 s0 [04:00]
14	BRAZINSKAITE I. (LTU)	000 s0 / 010 s1 [04:00]	42	OUWERKERK S. (NED)	000 s0 / 022 s0 [03:24]
15	ALONSO FERNANDEZ S. (ESP)	011 s0 / 002 s0 [04:00]	43	MEKAITON S. (ISR)	010 s1 / 000 s1 [04:00]
16	KRONENTHAL C. (GER)	100 s0 / 000 s0 [01:16]	44	ACTIS M. (ITA)	100 s2 / 000 s2 [02:59]

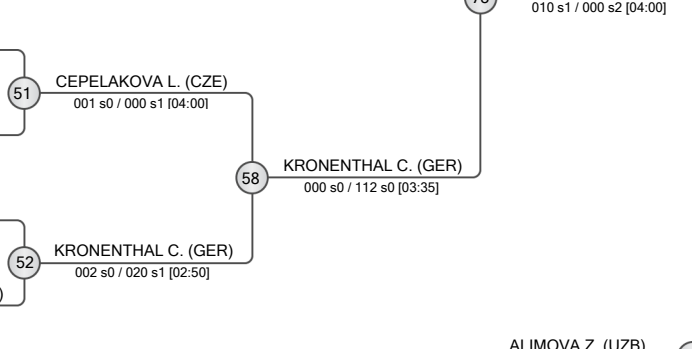

POOL C

	KHAZRATOVA Gulshanam	UZB
	TOPCU Ezgi	TUR
	HAYUN Romy	ISR
	SAS-ZALOZIECKI Valerie	AUT
	OUWERKERK Shayen	NED
	DANISOVA Ema	SVK
	BRIAND Lea	GER
	MEKAITON Shira	ISR
	GUERRERO PADIN Ines	ESP
	MAMMADTAGHIYEVA Gulnaz	AZE
	BAUER Sina Josefin	GER
	ACTIS Margherita	ITA
	NEBHUTH Sophia	GER
	KERSYTE Airuna	LTU
	MITCHELL Evie	GBR

17	KHAZRATOVA G. (UZB)	41	KHAZRATOVA G. (UZB)		
18	TOPCU E. (TUR)	003 s0 / 001 s0 [04:00]	42	OUWERKERK S. (NED)	002 s0 / 000 s0 [04:00]
19	OUWERKERK S. (NED)	000 s0 / 022 s0 [03:24]	43	MEKAITON S. (ISR)	001 s2 / 000 s0 [04:00]
20	DANISOVA E. (SVK)	020 s0 / 000 s0 [01:49]	44	ACTIS M. (ITA)	100 s2 / 000 s2 [02:59]
21	MEKAITON S. (ISR)	010 s1 / 000 s1 [04:00]	45	CHERNOVA C. (POR)	100 s1 / 000 s1 [01:05]
22	MAMMADTAGHIYEVA G. (AZE)	010 s0 / 000 s0 [04:00]	46	ZINK M. (GER)	110 s0 / 000 s0 [03:49]
23	ACTIS M. (ITA)	002 s0 / 100 s0 [01:16]	47	HASID D. (ISR)	002 s1 / 000 s0 [04:00]
24	MITCHELL E. (GBR)	000 s0 / 100 s0 [01:02]	48	NARRAIN K. (GER)	000 s0 / 100 s0 [00:18]

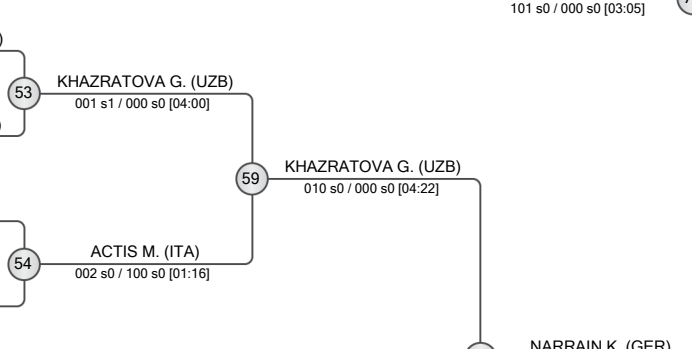

POOL D

	CHERNOVA Carina	POR
	MANECK Mia	GER
	CAMERON Stella	GBR
	ZINK Maxima	GER
	LUOTO Eila	FIN
	ABU JAHRUR Ines	BEL
	BIXA Luzia	AUT
	HASID Daniella	ISR
	AHMADZADA Yaghmur	AZE
	BELLEVAL Jaines	FRA
	STAIU Patricia	ROU
	GRUEVA Dara	BUL
	NARRAIN Katharina	GER
	TASCON MARTIN Minerva	ESP

25	CHERNOVA C. (POR)	45	CHERNOVA C. (POR)		
26	MANECK M. (GER)	100 s2 / 000 s1 [01:52]	46	ZINK M. (GER)	110 s0 / 000 s0 [03:49]
27	CAMERON S. (GBR)	100 s0 / 000 s0 [02:16]	47	HASID D. (ISR)	002 s1 / 000 s0 [04:00]
28	ABU JAHRUR I. (BEL)	101 s0 / 000 s0 [01:16]	48	NARRAIN K. (GER)	000 s0 / 100 s0 [00:18]
29	HASID D. (ISR)	000 s0 / 020 s0 [01:12]	49	KILDEEVA D. (FIN)	000 s0 / 100 s0 [00:00]
30	BELLEVAL J. (FRA)	000 s0 / 020 s0 [01:12]	50	BAECHLE S. (GER)	010 s0 / 100 s0 [01:18]
31	GRUEVA D. (BUL)	000 s1 / 001 s1 [04:00]	51	ALONSO FERNANDEZ S. (ESP)	000 s1 / 111 s0 [02:09]
32	NARRAIN K. (GER)	100 s0 / 000 s0 [01:18]	52	PULJIC L. (CRO)	000 s0 / 020 s0 [02:21]

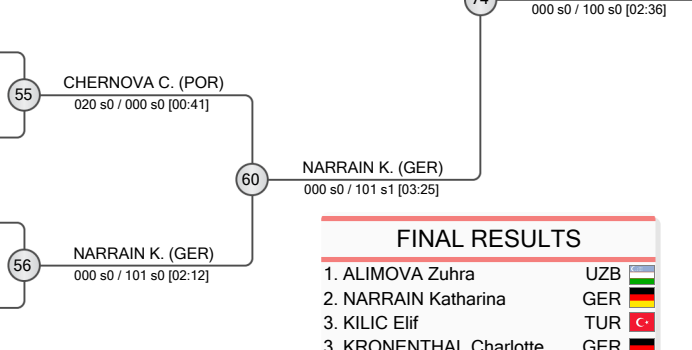

REPECHAGE

61	KILDEEVA D. (FIN)	65	KILDEEVA D. (FIN)
62	ALONSO FERNANDEZ S. (ESP)	66	PULJIC L. (CRO)
63	TOPCU E. (TUR)	67	OUWERKERK S. (NED)
64	GRUEVA D. (BUL)	68	HASID D. (ISR)

65	KILDEEVA D. (FIN)	69	KILIC E. (TUR)
66	PULJIC L. (CRO)	70	CEPELAKOVA L. (CZE)
67	OUWERKERK S. (NED)	71	OUWERKERK S. (NED)
68	HASID D. (ISR)	72	CHERNOVA C. (POR)

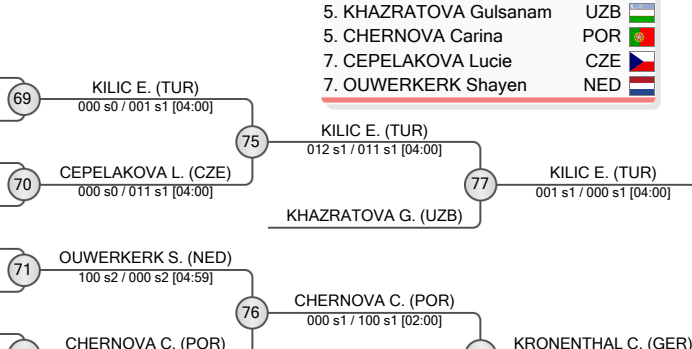

FINAL RESULTS

- ALIMOVA Zuhra (UZB)
- NARRAIN Katharina (GER)
- KILIC Elif (TUR)
- KRONENTHAL Charlotte (GER)
- KHAZRATOVA Gulshanam (UZB)
- CHERNOVA Carina (POR)
- CEPELAKOVA Lucie (CZE)
- OUWERKERK Shayen (NED)





Berlin Millennium Team Cadet European Cup 2026

Germany, Berlin, 25-26 Apr 2026

-63 kg

Women (48)

POOL A

	BILEN Sevim Margaret	TUR
	KUTKEVICA Sofija	LAT
	SMITH Kayla	GBR
	VAN SON Frederique	NED
	LUEDTKE Lea Sophie	GER
	ROITBERG Emma	ITA
	VON LUTZ Sophia	AUT
	CALDEIRA Matilde	POR
	GONZALEZ ROMANILLOS Leyre	ESP
	CHIRILA Annalisa Nicole	ROU
	VALIYEVA Nazakat	AZE
	GRAFE Lene	GER

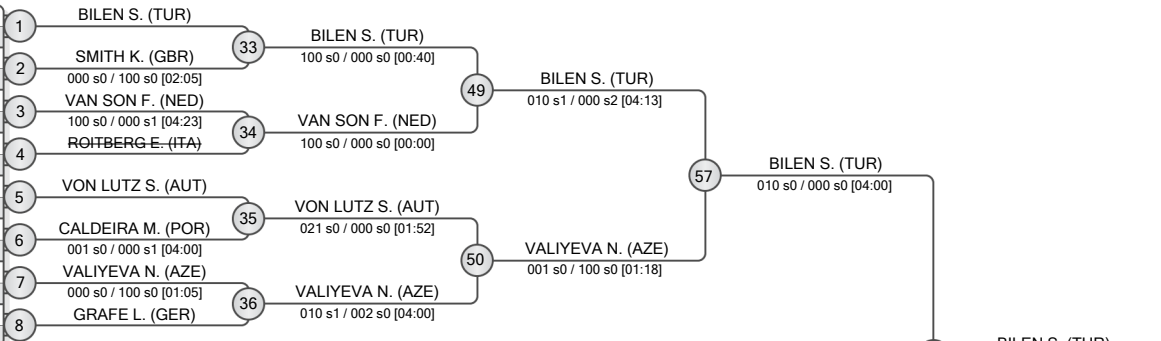

POOL B

	YILMAZ Duru	TUR
	BARONI Chiara	SUI
	GARCIA MONTES Judith Eloisa	ESP
	ROEMMER Amelie	GER
	LE TOUZE Lou	FRA
	KULIKAUSKAITE Meida	LTU
	STOEVA Andrea	BUL
	MUSAZZI Asia	ITA
	SHADI Gaida	AUT
	STOCK Luisa	GER
	KADYRKULOVA Medina	KGZ
	KROL Adel	ISR

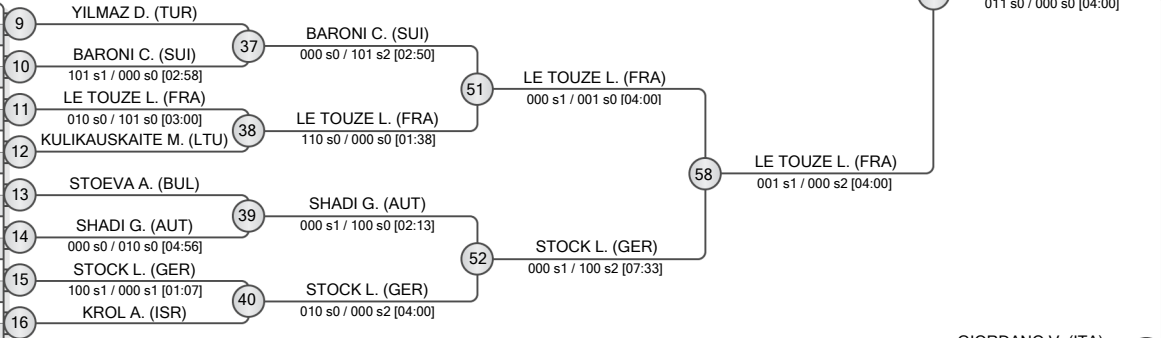

POOL C

	MASHURENKO Arina	UKR
	MATOUSKOVA Valentyna	CZE
	RODRIGUEZ SAENZ Ines	ESP
	BUETTNER Antonia	GER
	VASCO Ines	POR
	TREMBATCH Anna	FRA
	GLIGA Ana	ROU
	KAIN Kiara	AUT
	KOHLMANNLEHNER Nadja Alexandra	GER
	HUSEYNLI Zilan	AZE
	ZYGOMALA Ilektra	GRE
	BALYKIN Eden	ISR

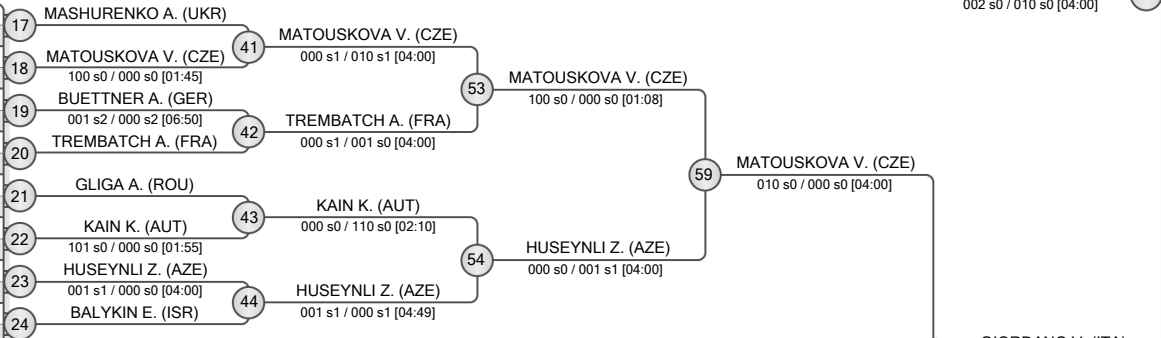

POOL D

	RAMA Bleona	AUT
	BJORK DALBERG Lova	SWE
	ZAHHAROVA Anastasia	EST
	GUENTHER Salima	GER
	ZHARASHUEVA Hanifa	BEL
	CRISOSTOMO Joana Filipa	POR
	KYIALBEKOVA Aaisha	KGZ
	STRUJJK Jayda	NED
	MAMMADLI Turkan	AZE
	BESTAV Selin	TUR
	GIORDANO Valeria	ITA
	VOLK Latika	GER

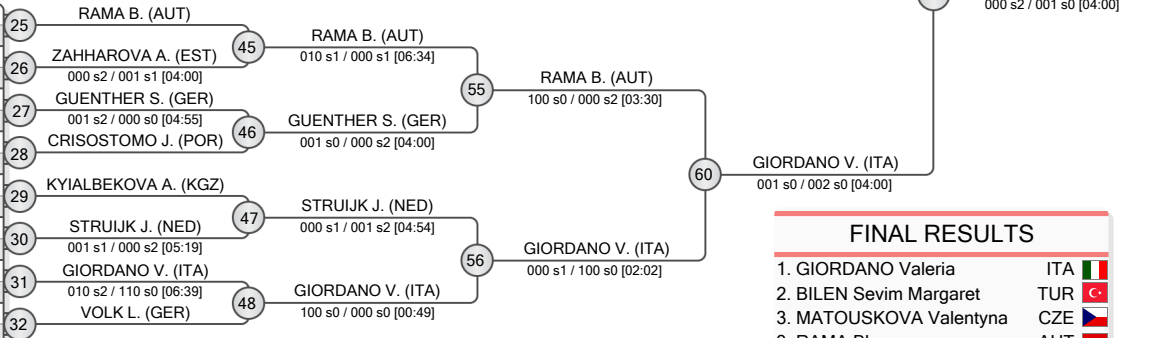

FINAL RESULTS		
1.	GIORDANO Valeria	ITA
2.	BILEN Sevim Margaret	TUR
3.	MATOUSKOVA Valentyna	CZE
3.	RAMA Bleona	AUT
5.	VAN SON Frederique	NED
7.	LE TOUZE Lou	FRA
7.	HUSEYNLI Zilan	AZE

REPECHAGE

SMITH K. (GBR)	61	SMITH K. (GBR)	65	VAN SON F. (NED)	69	VAN SON F. (NED)	75	VAN SON F. (NED)	77	MATOUSKOVA V. (CZE)
ROEMMER A. (GER)	62	ROEMMER A. (GER)	66	ROEMMER A. (GER)	70	STOCK L. (GER)	76	RAMA B. (AUT)	78	RAMA B. (AUT)
KULIKAUSKAITE M. (LTU)	63	MASHURENKO A. (UKR)	67	MASHURENKO A. (UKR)	71	HUSEYNLI Z. (AZE)	72	RAMA B. (AUT)	78	RAMA B. (AUT)
RODRIGUEZ SAENZ I. (ESP)	64	BESTAV S. (TUR)	68	BESTAV S. (TUR)	72	RAMA B. (AUT)	78	RAMA B. (AUT)	78	RAMA B. (AUT)

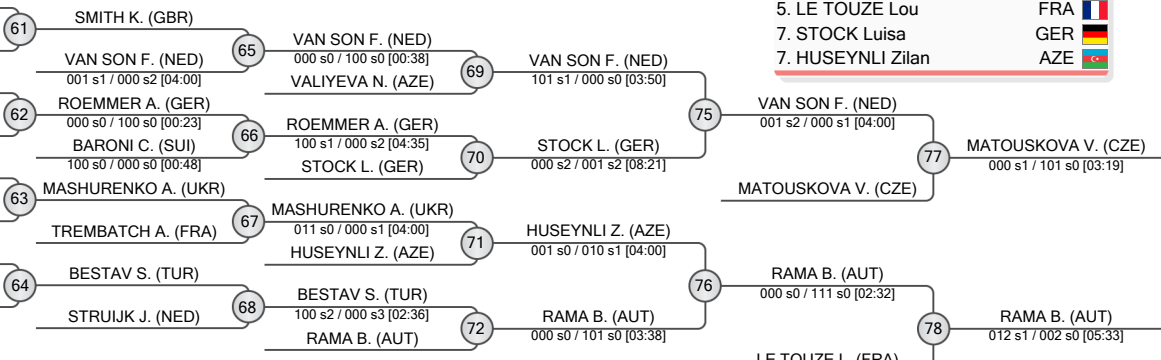



Berlin Millennium Team Cadet European Cup 2026

Germany, Berlin, 25-26 Apr 2026

-70 kg

Women (33)

POOL A

	WOEGERER Selina	AUT	1
	DAVIES Robyn	GBR	2
	KARATAS Busra	TUR	3
	PILZ Amelie Fabienne	GER	4
	VENDRIG Esmee	NED	5
	LEANZA Dorina	BEL	6
	MALCZAK Lara Katharina	GER	7
	MBENGUE RUANO Deguene Aisha	ESP	8

1	WOEGERER S. (AUT)	33	WOEGERER S. (AUT)	100 s0 / 000 s0 [00:20]
2	DAVIES R. (GBR)			
3	KARATAS B. (TUR)			
4	PILZ A. (GER)	34	PILZ A. (GER)	002 s0 / 100 s1 [02:34]
5	VENDRIG E. (NED)			
6	LEANZA D. (BEL)	35	VENDRIG E. (NED)	100 s2 / 000 s3 [02:40]
7	MALCZAK L. (GER)			
8	MBENGUE RUANO D. (ESP)	36	MALCZAK L. (GER)	001 s2 / 000 s0 [04:00]

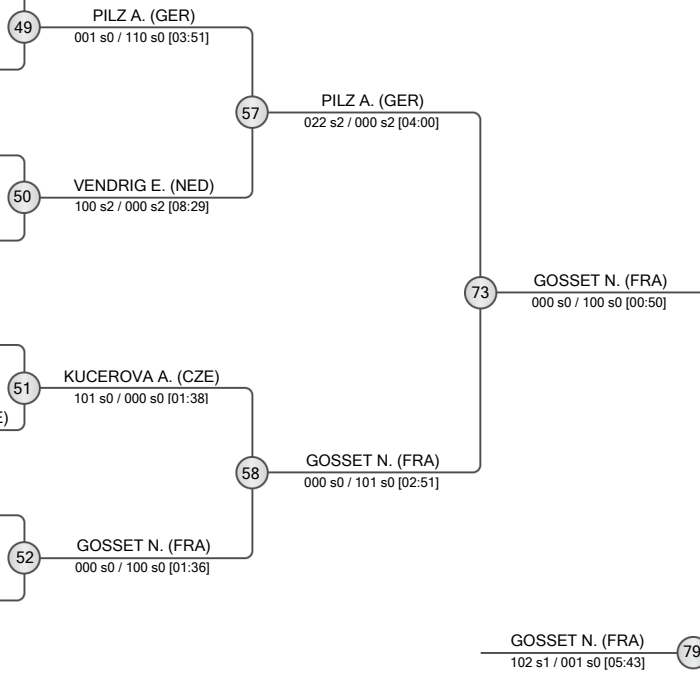

POOL B

	FILZWIESER Emma	AUT	9
	KUCEROVA Anna	CZE	10
	PAPAIOANNOU Maria Eleni	GRE	11
	KOCNIK Mia Juno	GER	12
	MAMMADLI Masuma	AZE	13
	MEGLAJ Erika	CRO	14
	GOSSET Norah	FRA	15
	WIKENE Ingrid	NOR	16

9	FILZWIESER E. (AUT)	37	KUCEROVA A. (CZE)	000 s0 / 020 s1 [03:38]
10	KUCEROVA A. (CZE)			
11	PAPAIOANNOU M. (GRE)			
12	KOCNIK M. (GER)	38	PAPAIOANNOU M. (GRE)	010 s2 / 000 s1 [04:00]
13	MAMMADLI M. (AZE)			
14	MEGLAJ E. (CRO)	39	MAMMADLI M. (AZE)	100 s0 / 000 s0 [00:18]
15	GOSSET N. (FRA)			
16	WIKENE I. (NOR)	40	GOSSET N. (FRA)	020 s0 / 000 s0 [01:45]

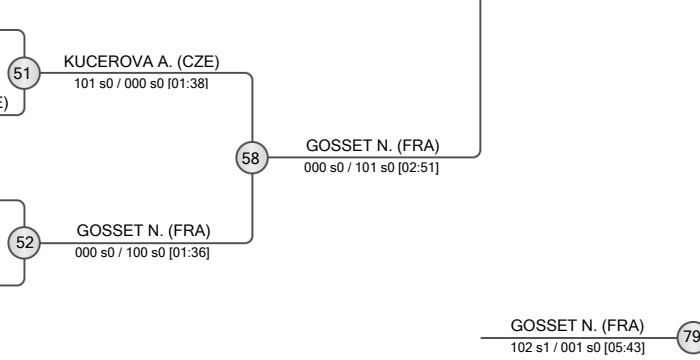

POOL C

	KARAFFOVA Vanessa	CZE	17
	AHMADOVA Rena	AZE	18
	GIL LEITAO Madalena	POR	19
	KEDING Svenja	GER	20
	OZBUDAK Done Melike	TUR	21
	ZSCHIESCHE Frieda Hanni	GER	22
	AUBRY Omairaa	FRA	23
	ZAPOROJANU Sofia	MDA	24

17	KARAFFOVA V. (CZE)	41	KARAFFOVA V. (CZE)	020 s0 / 000 s1 [01:21]
18	AHMADOVA R. (AZE)			
19	GIL LEITAO M. (POR)	42	GIL LEITAO M. (POR)	021 s0 / 001 s0 [02:06]
20	KEDING S. (GER)			
21	OZBUDAK D. (TUR)	43	OZBUDAK D. (TUR)	011 s0 / 000 s1 [04:00]
22	ZSCHIESCHE F. (GER)			
23	AUBRY O. (FRA)	44	AUBRY O. (FRA)	012 s0 / 001 s1 [04:00]
24	ZAPOROJANU S. (MDA)			

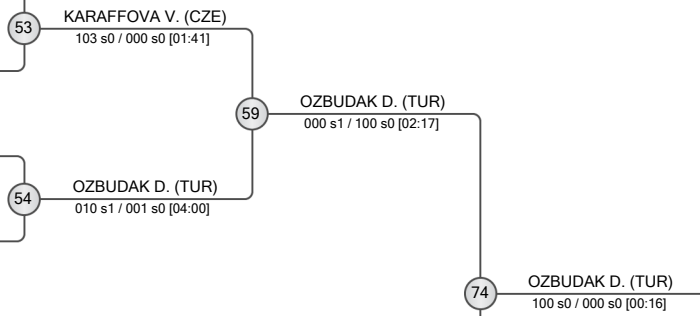

POOL D

	HUDIKA Vita	CRO	25
	ZUIDWIJK Noel	NED	26
	LATKOWSKI Antonia	GER	27
	RABL Nia	AUT	28
	FARAUANU Iasmina	ROU	28
	ZELL Amit	ISR	29
	THIERY Emilie	GER	30
	GALBRAITH Zoe	GBR	31
	JUMABAEVA Poshshajon	UZB	32

25	HUDIKA V. (CRO)	45	ZUIDWIJK N. (NED)	001 s2 / 010 s1 [04:00]
26	ZUIDWIJK N. (NED)			
27	LATKOWSKI A. (GER)	46	LATKOWSKI A. (GER)	100 s0 / 000 s0 [02:50]
28	FARAUANU I. (ROU)			
29	ZELL A. (ISR)	47	ZELL A. (ISR)	001 s0 / 000 s0 [04:00]
30	THIERY E. (GER)			
31	GALBRAITH Z. (GBR)	48	JUMABAEVA P. (UZB)	000 s3 / 100 s0 [02:46]
32	JUMABAEVA P. (UZB)			

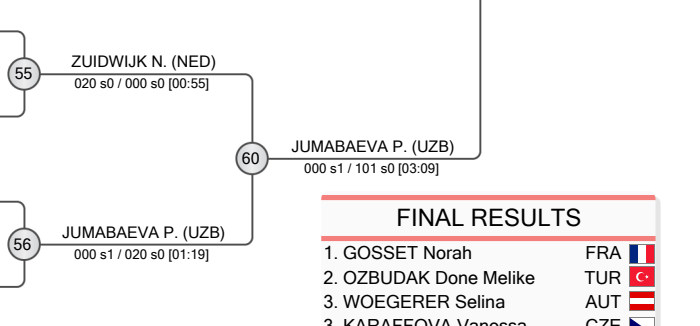

FINAL RESULTS		
1.	GOSSET Norah	FRA
2.	OZBUDAK Done Melike	TUR
3.	WOEGERER Selina	AUT
3.	KARAFFOVA Vanessa	CZE
5.	JUMABAEVA Poshshajon	UZB
5.	PILZ Amelie Fabienne	GER
7.	KUCEROVA Anna	CZE
7.	ZELL Amit	ISR

REPECHAGE

	KARATAS B. (TUR)	61	KARATAS B. (TUR)	
	WOEGERER S. (AUT)	65	WOEGERER S. (AUT)	
	WIKENE I. (NOR)	62	WIKENE I. (NOR)	
	ZSCHIESCHE F. (GER)	63	ZSCHIESCHE F. (GER)	
	GALBRAITH Z. (GBR)	64	GALBRAITH Z. (GBR)	

	WOEGERER S. (AUT)	65	WOEGERER S. (AUT)	000 s1 / 010 s1 [04:00]
	WIKENE I. (NOR)	62	MAMMADLI M. (AZE)	000 s0 / 001 s2 [05:24]
	ZSCHIESCHE F. (GER)	63	AUBRY O. (FRA)	000 s0 / 020 s0 [01:54]
	GALBRAITH Z. (GBR)	64	ZELL A. (ISR)	000 s0 / 001 s1 [04:00]
		66	KUCEROVA A. (CZE)	000 s0 / 100 s0 [00:48]
		67	KARAFFOVA V. (CZE)	000 s1 / 100 s0 [02:12]
		68	ZUIDWIJK N. (NED)	112 s1 / 000 s0 [02:52]

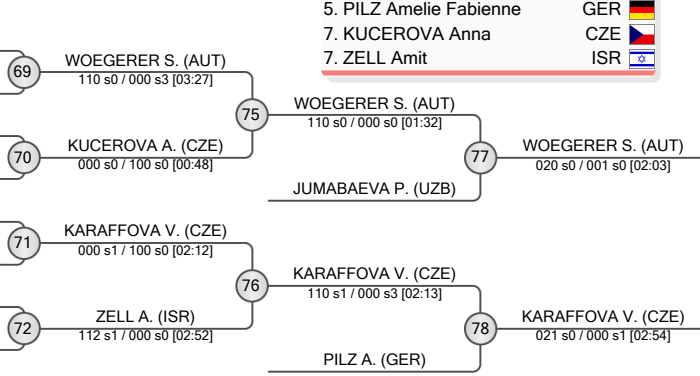



Berlin Millennium Team Cadet European Cup 2026

Germany, Berlin, 25-26 Apr 2026

+ 70 kg

Women (16)

POOL A

	BALCI Hatice Tuana	TUR
	WANDJI Maelyne	FRA
	VAN DRIEL Nova	NED
	BARNEKOW Lena Sophie	GER

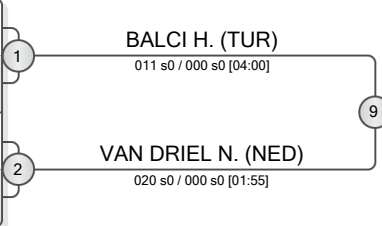

POOL B

	PALERMO Elisa	ITA
	MOROU Hidaya	GER
	MAGASSA FOFANA Sogona	ESP
	VAN SUNDERT Fleur	NED

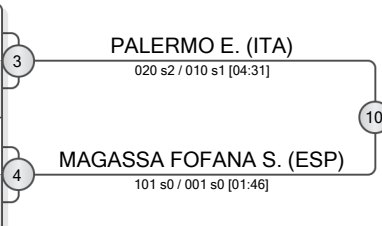

POOL C

	COULIBALY TOURE Ballalo	ESP
	DECKER Meerit	GER
	SASSA-TATUKILA Therese-Grace	FRA
	HERMANS Tess	NED

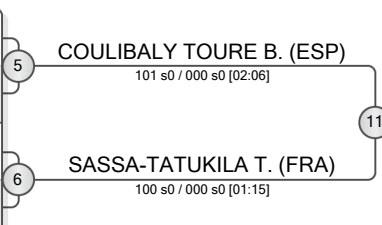

POOL D

	CHERKELIEVA Maria	BUL
	CONRAD Lucia	DEN
	ALIYEVA Zemfira	AZE
	BUSCHMANN Elisabeth	GER

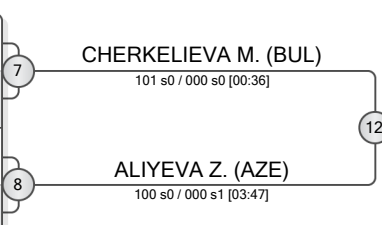

REPECHAGE

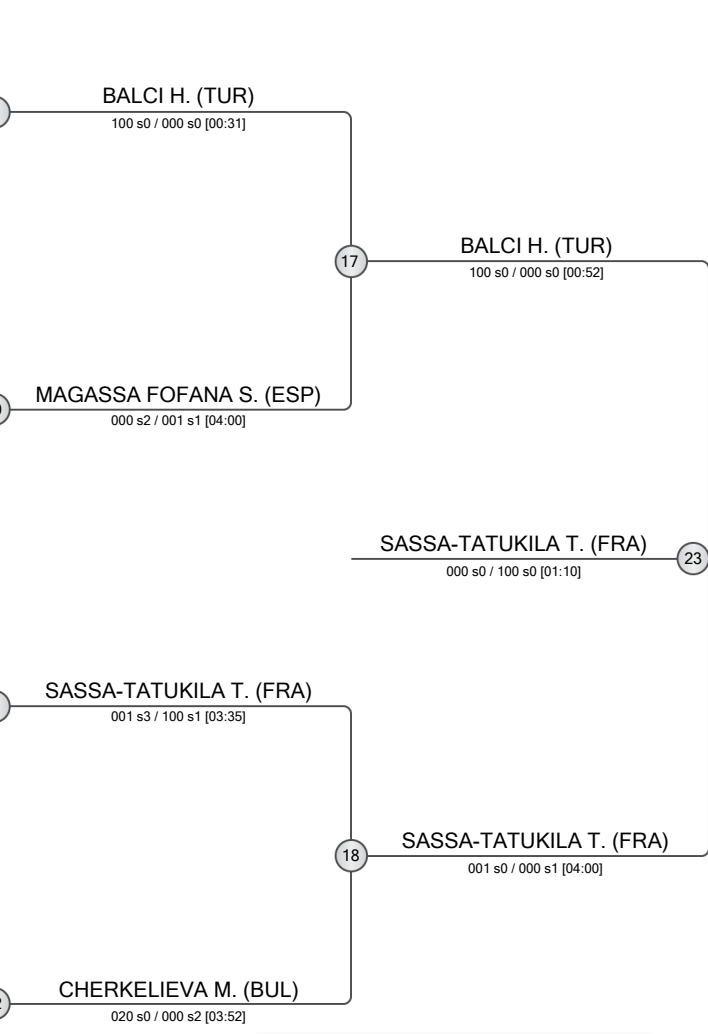

FINAL RESULTS		
1.	SASSA-TATUKILA Therese-Grace	FRA
2.	BALCI Hatice Tuana	TUR
3.	WANDJI Maelyne	FRA
5.	CHERKELIEVA Maria	BUL
5.	MAGASSA FOFANA Sogona	ESP
7.	PALERMO Elisa	ITA
7.	ALIYEVA Zemfira	AZE

