



Teplice Millennium Team Cadet European Cup 2025

Czechia, Teplice, 5-6 Apr 2025

-50 kg

Men (30)

POOL A

	CUQ Axel	FRA
	MORO Andrea	ITA
	BAUER Eddie	GER
	CIMBOLAS Timas	LTU
	SANTOS Joao Almeida	POR
	CZINEGE David	HUN
	MARCHIORI Ugo	LUX

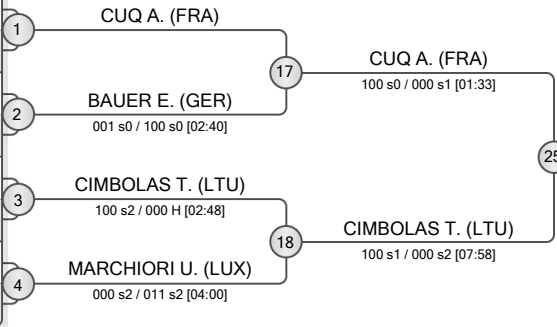

POOL B

	DOBROWOLSKI Bartlomiej	POL
	PORTELLI Leonardo	ITA
	LEMONS RODRIGUEZ Omar	ESP
	JAKL Marek	CZE
	CHIARELLA Luca	ITA
	GUL Ibrahim	TUR
	ZIMMERMANN Felix	GER
	STETS Kiril	UKR

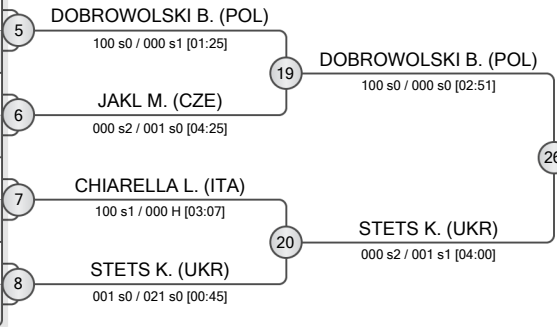

POOL C

	AVRAMOVIC Boban	SRB
	PAK Albert	POL
	KURGANS Edgars	LAT
	GULUA Aleksii	GEO
	MEHABRA Ismael	ITA
	CONSTANTINIDES Angelos	CYP
	MARCHUK Serhii	UKR

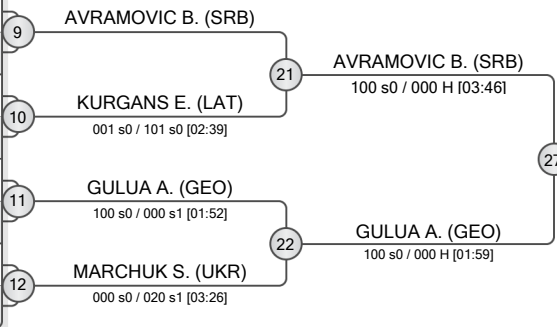

POOL D

	GULIYEV Anar	AZE
	VILLA Tim	FRA
	DOUINE Matteo	ITA
	PALKO Daniel	SVK
	TALIBOV Ibrahim	AZE
	COLAK Ismail	AUT
	KITAGAWA Julius	GER
	HUNTER Luke	GBR

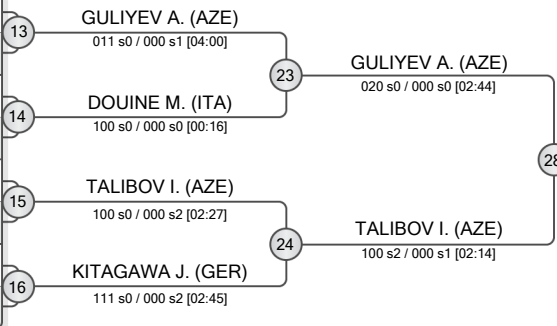

REPECHAGE

BAUER E. (GER) 29	BAUER E. (GER)	33	CIMBOLAS T. (LTU)
PORTELLI L. (ITA)	CIMBOLAS T. (LTU)	34	STETS K. (UKR)
JAKL M. (CZE) 30	JAKL M. (CZE)	35	AVRAMOVIC B. (SRB)
MEHABRA I. (ITA)	MEHABRA I. (ITA)	36	TALIBOV I. (AZE)
MARCHUK S. (UKR) 31	AVRAMOVIC B. (SRB)		
VILLA T. (FRA)	VILLA T. (FRA)		
DOUINE M. (ITA) 32	TALIBOV I. (AZE)		

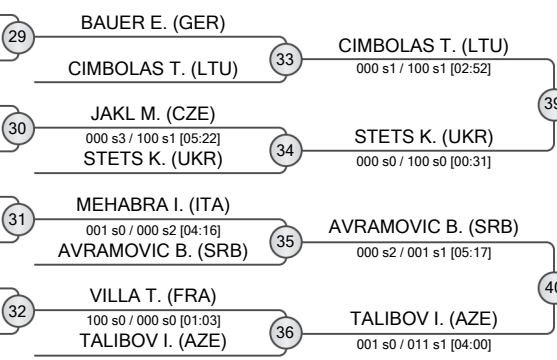

FINAL RESULTS

- GULUA Aleksii
- CUQ Axel
- GULIYEV Anar
- DOBROWOLSKI Bartlomiej
- STETS Kiril
- TALIBOV Ibrahim
- CIMBOLAS Timas
- AVRAMOVIC Boban





Teplice Millennium Team Cadet European Cup 2025

Czechia, Teplice, 5-6 Apr 2025

-55 kg

Men (60)

POOL A

1	BUTUCI Kristian (CRO)	1	BUTUCI K. (CRO)
2	GUR Ramazan Aykut (TUR)	33	GUR R. (TUR)
3	CERVINSKIS Bogdanas (LAT)	34	CERVINSKIS B. (LAT)
4	BACCI Lorenzo (ITA)	34	BACCI L. (ITA)
5	SILVA David Simoes (POR)	35	ALIZADA R. (AZE)
6	ALIZADA Rasul (AZE)	35	ALIZADA R. (AZE)
7	MARKOVICS Andrej (SVK)	36	MAINGOT V. (FRA)
8	FRANZ Leonard (GER)	36	MAINGOT V. (FRA)
	ALEKSEJUNAS Natas (LTU)		
	WENCEL Jakub (POL)		
	KURBANOV Djamil (AUT)		
	MARINO Vincenzo (ITA)		
	MAINGOT Victor (FRA)		

POOL B

9	CORI Silvano (SUI)	9	CORI S. (SUI)
10	SORICI Alin Marian (ROU)	37	SORICI A. (ROU)
11	RAMAZZOTTO Giulio (ITA)	38	ZVORC J. (CRO)
12	ZVORC Jona (CRO)	38	ZVORC J. (CRO)
13	BULINGER Daniel (GER)	39	GUALANDI M. (ITA)
14	CZALBOWSKI Szymon (POL)	39	HONTIUK R. (UKR)
15	SPINU Arsenijs (LAT)	40	PETSCHALLIES N. (GER)
16	GUALANDI Matteo (ITA)	40	PETSCHALLIES N. (GER)
17	KOSTOEV Adam (SWE)		
18	MARKOVIC Petar (SRB)		
19	HONTIUK Roman (UKR)		
20	SETROREDJO Levy (NED)		
21	PETSCHALLIES Noah (GER)		
22	WOJNA Dawid (POL)		
23	SIMON Yonatan (ISR)		

POOL C

17	JAKUBAUSKAS Adris (LTU)	41	JAKUBAUSKAS A. (LTU)
18	FUCHS Yuval (ISR)	42	SIENKIEWICZ R. (POL)
19	ORNIK Yann (AUT)	42	SIENKIEWICZ R. (POL)
20	SIENKIEWICZ Ryszard (POL)	43	UYAR C. (NED)
21	LUCIC Sime (CRO)	43	UYAR C. (NED)
22	GIVANNI Natan (ITA)	44	RUCINSKI-ZAJAC A. (POL)
23	OESTERWIND Max (GER)	44	RUCINSKI-ZAJAC A. (POL)
24	ZINCHUK Maksym (UKR)		
25	PETROVIC Nikola (SRB)		
26	FEST Benedikt (GER)		
27	UYAR Celil (NED)		
28	PIPAN Tim (SLO)		
29	EBNETER Ramon (SUI)		
30	KOLOSOV Kristo (EST)		
31	RUCINSKI-ZAJAC Antoni (POL)		

POOL D

25	LUCAS Titouan (FRA)	45	TATARYN N. (UKR)
26	TATARYN Nikita (UKR)	46	KATS M. (CZE)
27	GLENSKI Jakob (POL)	46	KATS M. (CZE)
28	HERMANN Leon (GER)	47	GHIDONI T. (ITA)
29	KATS Matvii (CZE)	47	GHIDONI T. (ITA)
30	DAMM Oliver (HUN)	48	MONTEIRO D. (POR)
31	FRANZESE Francesco (ITA)	48	MONTEIRO D. (POR)
32	HUSIYEV Mahammadali (AZE)		
33	GHIDONI Thomas (ITA)		
34	LOPEZ Ian (AND)		
35	LACIKA Silvio (SVK)		
36	MONTEIRO Davi (POR)		
37	KUIPERS John Vincent (NED)		
38	SAULITE Toms (LAT)		
39	SCHUMANN Janek Paul (GER)		

REPECHAGE

61	MARKOVICS A. (SVK)	65	MAINGOT V. (FRA)
62	ALEKSEJUNAS N. (LTU)	65	MAINGOT V. (FRA)
63	KOSTOEV A. (SWE)	66	HONTIUK R. (UKR)
64	HONTIUK R. (UKR)	66	HONTIUK R. (UKR)
65	FEST B. (GER)	67	ZINCHUK M. (UKR)
66	ZINCHUK M. (UKR)	67	ZINCHUK M. (UKR)
67	GLENSKI J. (POL)	68	LUCAS T. (FRA)
68	LUCAS T. (FRA)	68	LUCAS T. (FRA)
69	MARKOVICS A. (SVK)	69	MAINGOT V. (FRA)
70	MAINGOT V. (FRA)	69	MAINGOT V. (FRA)
71	HONTIUK R. (UKR)	70	CORI S. (SUI)
72	PETSCHALLIES N. (GER)	70	CORI S. (SUI)
73	HONTIUK R. (UKR)	71	JAKUBAUSKAS A. (LTU)
74	ZINCHUK M. (UKR)	71	JAKUBAUSKAS A. (LTU)
75	RUCINSKI-ZAJAC A. (POL)	72	LUCAS T. (FRA)
76	LUCAS T. (FRA)	72	LUCAS T. (FRA)
77	MARKOVICS A. (SVK)	72	LUCAS T. (FRA)
78	ALEKSEJUNAS N. (LTU)	72	LUCAS T. (FRA)
79	MAINGOT V. (FRA)	72	LUCAS T. (FRA)
80	BUTUCI K. (CRO)	72	LUCAS T. (FRA)
81	HONTIUK R. (UKR)	75	CORI S. (SUI)
82	PETSCHALLIES N. (GER)	75	CORI S. (SUI)
83	HONTIUK R. (UKR)	75	CORI S. (SUI)
84	FEST B. (GER)	75	CORI S. (SUI)
85	ZINCHUK M. (UKR)	75	CORI S. (SUI)
86	RUCINSKI-ZAJAC A. (POL)	75	CORI S. (SUI)
87	ZINCHUK M. (UKR)	75	CORI S. (SUI)
88	JAKUBAUSKAS A. (LTU)	75	CORI S. (SUI)
89	LUCAS T. (FRA)	75	CORI S. (SUI)
90	KATS M. (CZE)	75	CORI S. (SUI)
91	GHIDONI T. (ITA)	75	CORI S. (SUI)
92	MONTEIRO D. (POR)	75	CORI S. (SUI)
93	SCHUMANN J. (GER)	75	CORI S. (SUI)

FINAL RESULTS

- ALIZADA Rasul (AZE)
- UYAR Celil (NED)
- CORI Silvano (SUI)
- LUCAS Titouan (FRA)
- TATARYN Nikita (UKR)
- GUALANDI Matteo (ITA)
- MAINGOT Victor (FRA)
- ZINCHUK Maksym (UKR)





Teplice Millennium Team Cadet European Cup 2025

Czechia, Teplice, 5-6 Apr 2025

-60 kg

Men (71)

POOL A

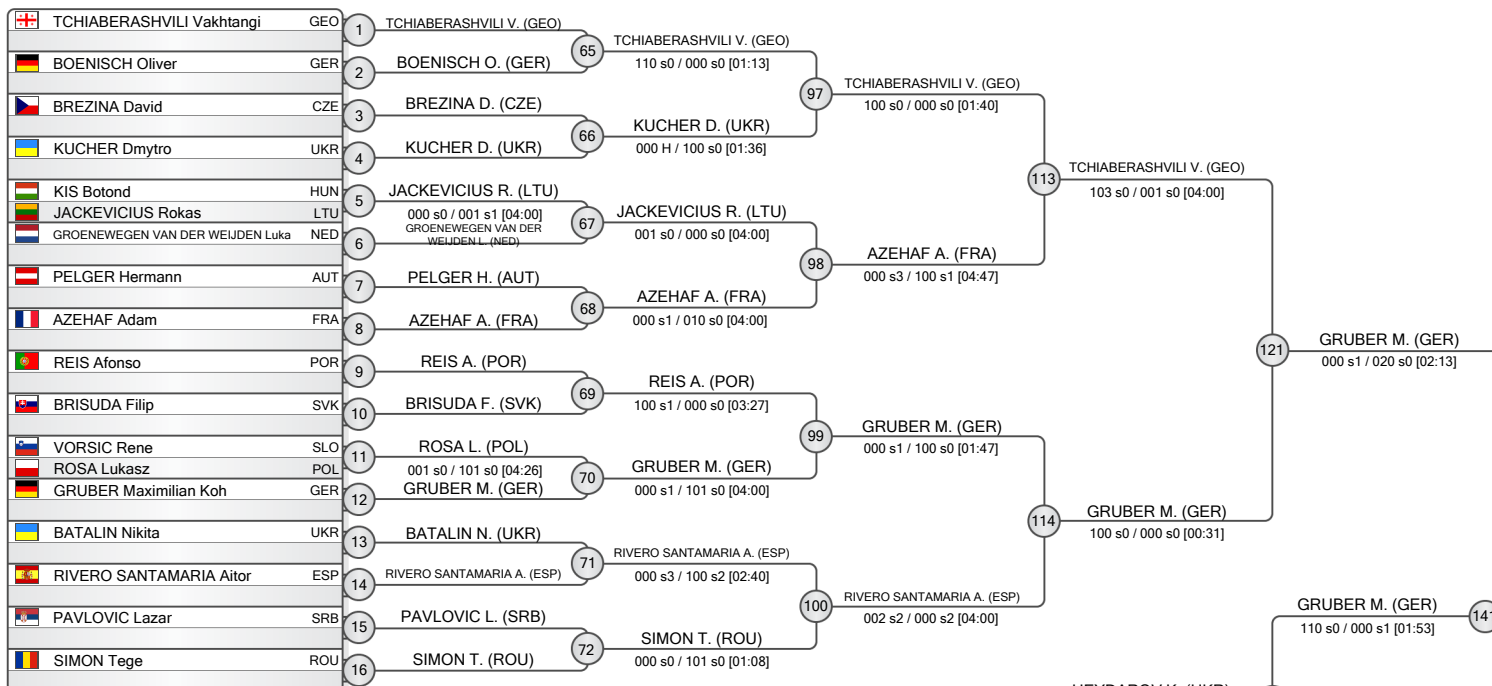

POOL B

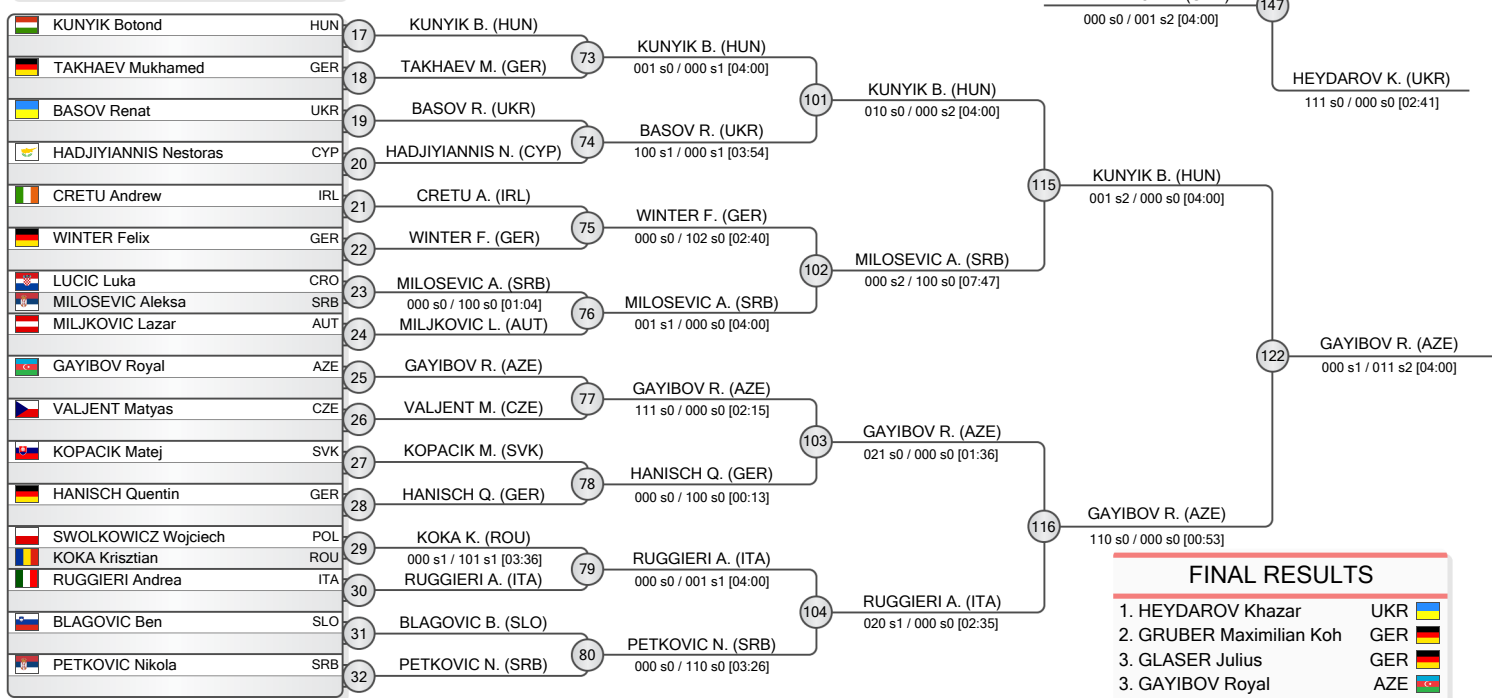

FINAL RESULTS

- HEYDAROV Khazar (UKR)
- GRUBER Maximilian Koh (GER)
- GLASER Julius (GER)
- GAYIBOV Royal (AZE)
- KUNYIK Botond (HUN)
- ESENBOGA Can Emirhan (TUR)
- TCHIBERASHVILI Vakhtangi (GEO)
- SCHRODL Kornel (HUN)

REPECHAGE

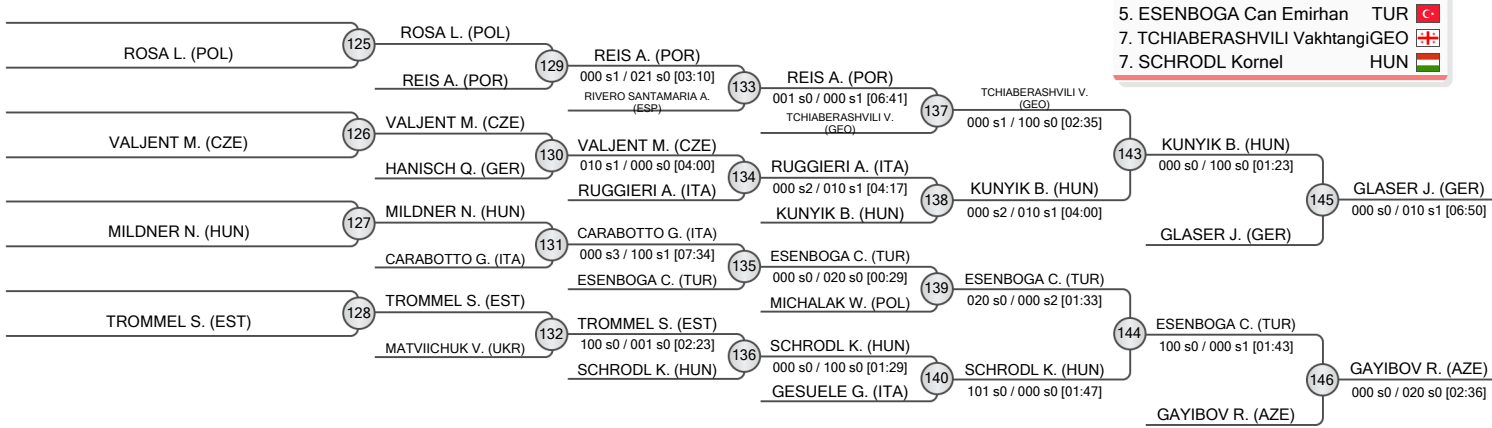



Teplice Millennium Team Cadet European Cup 2025

Czechia, Teplice, 5-6 Apr 2025

-60 kg

Men (71)

POOL C

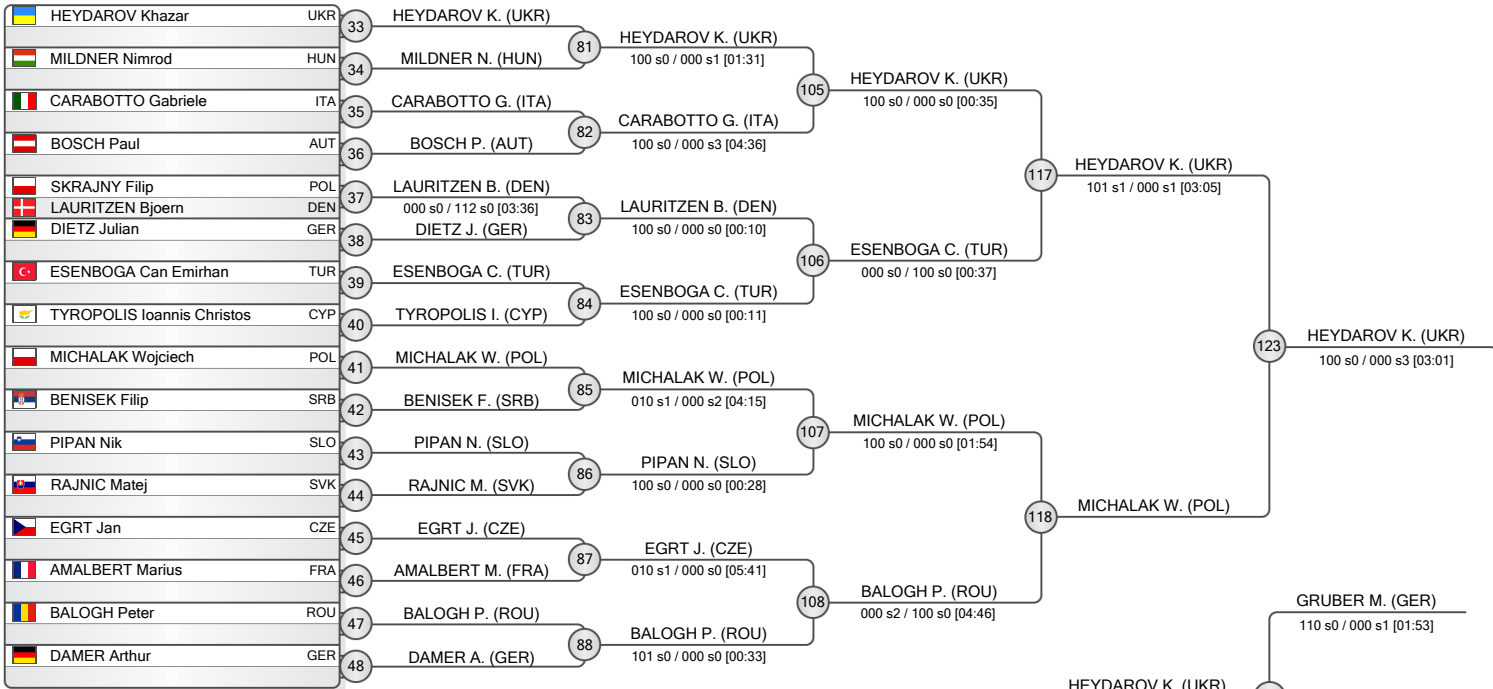

POOL D

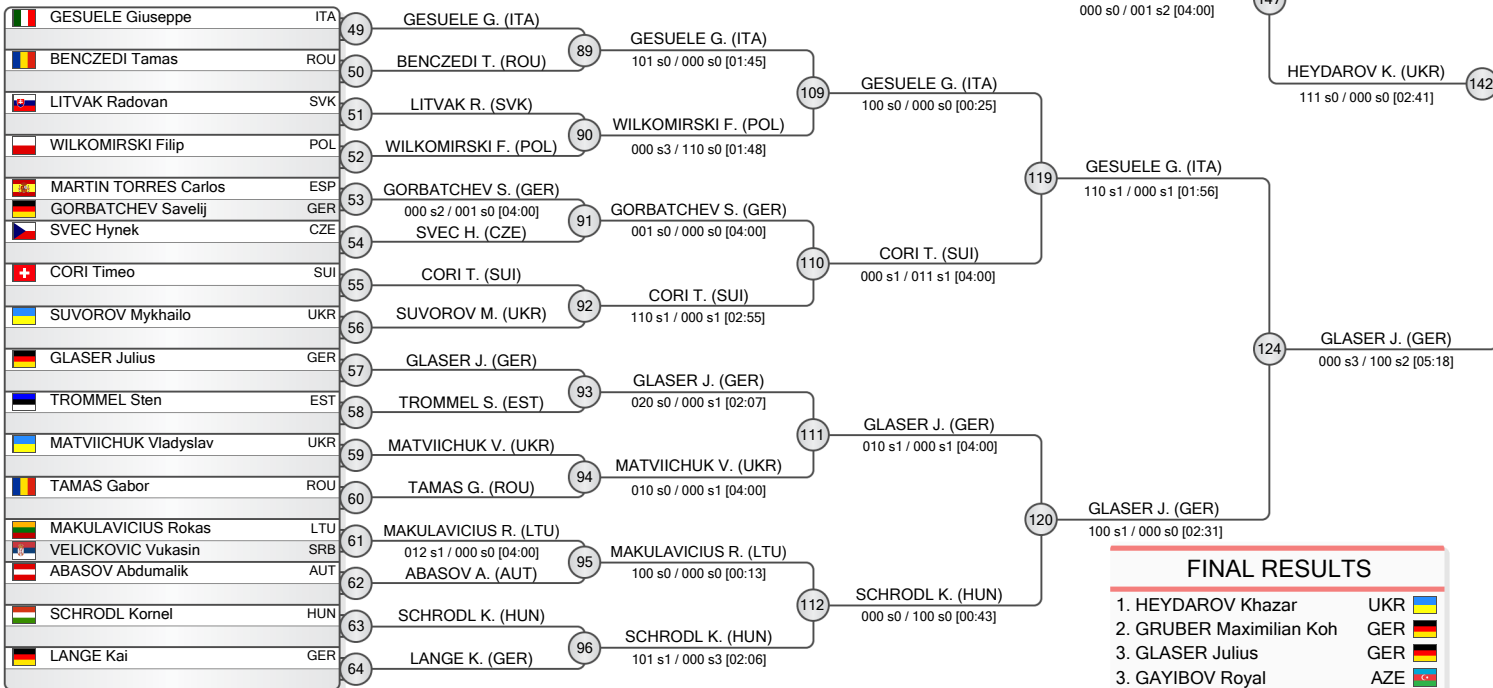

FINAL RESULTS

- HEYDAROV Khazar UKR
- GRUBER Maximilian Koh GER
- GLASER Julius GER
- GAYIBOV Royal AZE
- KUNYIK Botond HUN
- ESENBAGA Can Emirhan TUR
- TCHIBERASHVILI Vaktangi GEO
- SCHRODL Kornel HUN

REPECHAGE

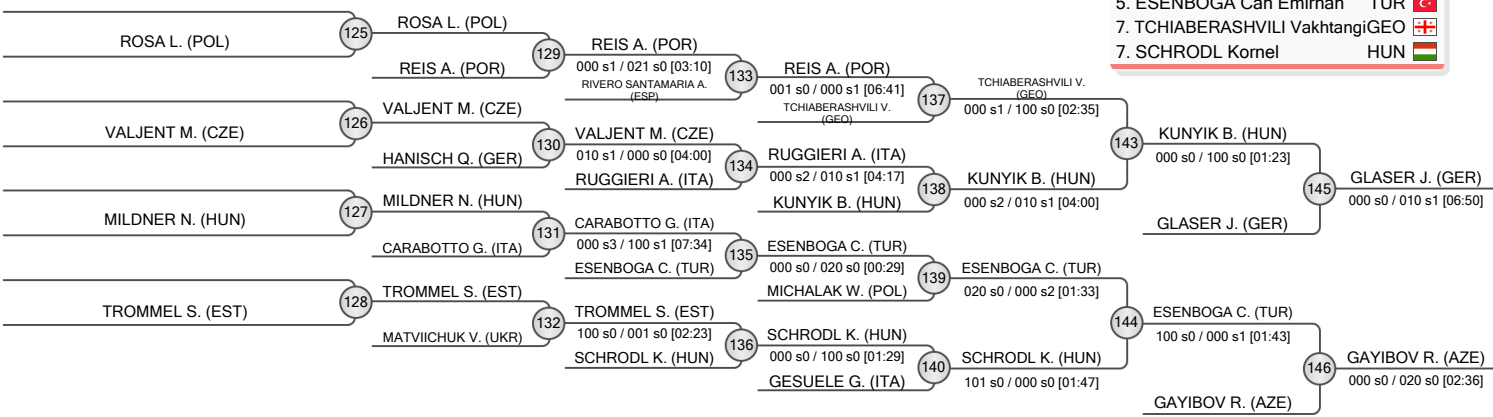



Teplice Millennium Team Cadet European Cup 2025

Czechia, Teplice, 5-6 Apr 2025

-66 kg

Men (95)

POOL A

NAZARENKO Illia	UKR	1	NAZARENKO I. (UKR)
BURTSCHER Philipp	AUT	2	RUPPRICH A. (GER)
RUPPRICH Albert	GER		000 s1 / 101 s0 [03:56]
LE DUC Tri	CZE	3	LE DUC T. (CZE)
GIANNONE Stefano	ITA		010 s1 / 001 s1 [04:00]
TODOROVIC Ivan	CRO	4	TODOROVIC I. (CRO)
			110 s0 / 010 s0 [04:14]
LAFORGE Yann	FRA	5	LAFORGE Y. (FRA)
KAPUSNIAK Kacper	POL		101 s0 / 010 s1 [03:10]
KURGHINYAN Misha	NED	6	KURGHINYAN M. (NED)
			001 s1 / 000 s1 [04:00]
SCHUERER Hannes	GER	7	GAL K. (HUN)
GAL Kristof	HUN		001 s1 / 011 s0 [04:52]
MILOVIC Lan	SLO	8	MILOVIC L. (SLO)
			110 s0 / 000 s1 [02:26]
HOMKA Eriks	LAT	9	HOMKA E. (LAT)
			100 s0 / 001 s0 [03:10]
JANUSIS Zygimantas	LTU	10	TSCHERHEIKO M. (GER)
TSCHERHEIKO Malik	GER		001 s1 / 100 s1 [02:53]
PAIVA Nuno	POR	11	ONAY N. (TUR)
ONAY Numan	TUR		000 s0 / 100 s0 [00:15]
LIBRA Marek	CZE	12	LIBRA M. (CZE)
			100 s0 / 000 s0 [00:12]
WROBEL Tomasz	POL	13	BEZPALENKO D. (AUT)
BEZPALENKO Davyd	AUT		000 s2 / 001 s1 [04:00]
HRYNKO Bohdan	UKR	14	HRYNKO B. (UKR)
			000 s0 / 001 s0 [04:00]
PAVLOVIC Luka	SRB	15	ERCOLI A. (ITA)
ERCOLI Alessandro	ITA		000 s1 / 110 s0 [02:37]
HARUTA Ion	GER	16	HARUTA I. (GER)
			100 s0 / 000 s0 [02:01]

POOL B

NOGES Georg	EST	17	NOGES G. (EST)
ATAMANIUK Rostyslav	GER	18	ATAMANIUK R. (GER)
WATOLA Mateusz	POL		101 s0 / 000 s0 [03:16]
MOUSIKOS Nikolas	CYP	19	PAUSKIC S. (DEN)
PAUSKIC Silas	DEN		000 s0 / 111 s0 [00:53]
MANSUR Marwan	ROU	20	MANSUR M. (ROU)
			000 s0 / 100 s0 [01:29]
ALVES Joao Tiago	POR	21	ALVES J. (POR)
SERAFINI Christian	ITA		001 s1 / 000 s2 [05:08]
HACKSTEINER Michael	AUT	22	HACKSTEINER M. (AUT)
			020 s0 / 000 s0 [02:00]
NAGY Aron	HUN	23	NAGY A. (HUN)
			100 s0 / 000 s0 [01:36]
MEISSNER Barnabas	GER	24	MEISSNER B. (GER)
			100 s0 / 000 s0 [01:36]
HUMBATOV Ali	AZE	25	HUMBATOV A. (AZE)
			101 s0 / 000 s0 [00:40]
NEMASIK Matej	SVK	26	NEMASIK M. (SVK)
KILADZE Lazare	GER		100 s0 / 000 s0 [02:15]
BALAYEV Samir	FIN	27	BALAYEV S. (FIN)
PRICHYSTAL Leon	CZE		010 s2 / 000 s2 [04:10]
CORIC Martino	GER	28	CORIC M. (GER)
			002 s0 / 000 s2 [04:00]
SEMENOBYCH Orest	UKR	29	GONDOR K. (HUN)
GONDOR Kristof	HUN		000 s1 / 001 s0 [04:00]
CECI Emiliano	ITA	30	CECI E. (ITA)
			100 s0 / 000 s2 [03:10]
MIS Karol	POL	31	BUTKO R. (GER)
BUTKO Ruslan	GER		000 s0 / 100 s0 [01:27]
SOVINC Ozbej	SLO	32	SOVINC O. (SLO)
			110 s0 / 000 s0 [00:58]

REPECHAGE

RUPPRICH A. (GER)	125	RUPPRICH A. (GER)	129	RUPPRICH A. (GER)	133	RUPPRICH A. (GER)
LE DUC T. (CZE)		010 s2 / 000 s0 [04:00]		LAFORGE Y. (FRA)		100 s1 / 000 s0 [02:36]
NEMASIK M. (SVK)	126	NEMASIK M. (SVK)	130	BALAYEV S. (FIN)	134	BALAYEV S. (FIN)
BALAYEV S. (FIN)		000 s0 / 101 s0 [03:03]		GONDOR K. (HUN)		100 s2 / 000 s3 [05:24]
MATUZNYI D. (GER)	127	MATUZNYI D. (GER)	131	MATUZNYI D. (GER)	135	GULIYEV O. (AZE)
PAL N. (ROU)		100 s0 / 000 s0 [00:06]		GULIYEV O. (AZE)		000 s0 / 100 s0 [00:57]
TODOROVIC Z. (SRB)	128	TODOROVIC Z. (SRB)	132	TODOROVIC Z. (SRB)	136	TODOROVIC Z. (SRB)
KUTSON K. (EST)		001 s0 / 000 s0 [04:00]		BABUTSIDZE G. (GEO)		100 s1 / 002 s0 [03:29]



FINAL RESULTS		
1. OTEVREL Tomas	CZE	
2. NAZARENKO Illia	UKR	
3. GRUBER Julius	GER	
3. HUMBATOV Ali	AZE	
5. NOGES Georg	EST	
5. OSTAPENKO Bohdan	UKR	
7. HOMKA Eriks	LAT	
7. GULIYEV Ozgan	AZE	





Teplice Millennium Team Cadet European Cup 2025

Czechia, Teplice, 5-6 Apr 2025

-66 kg

Men (95)

POOL C

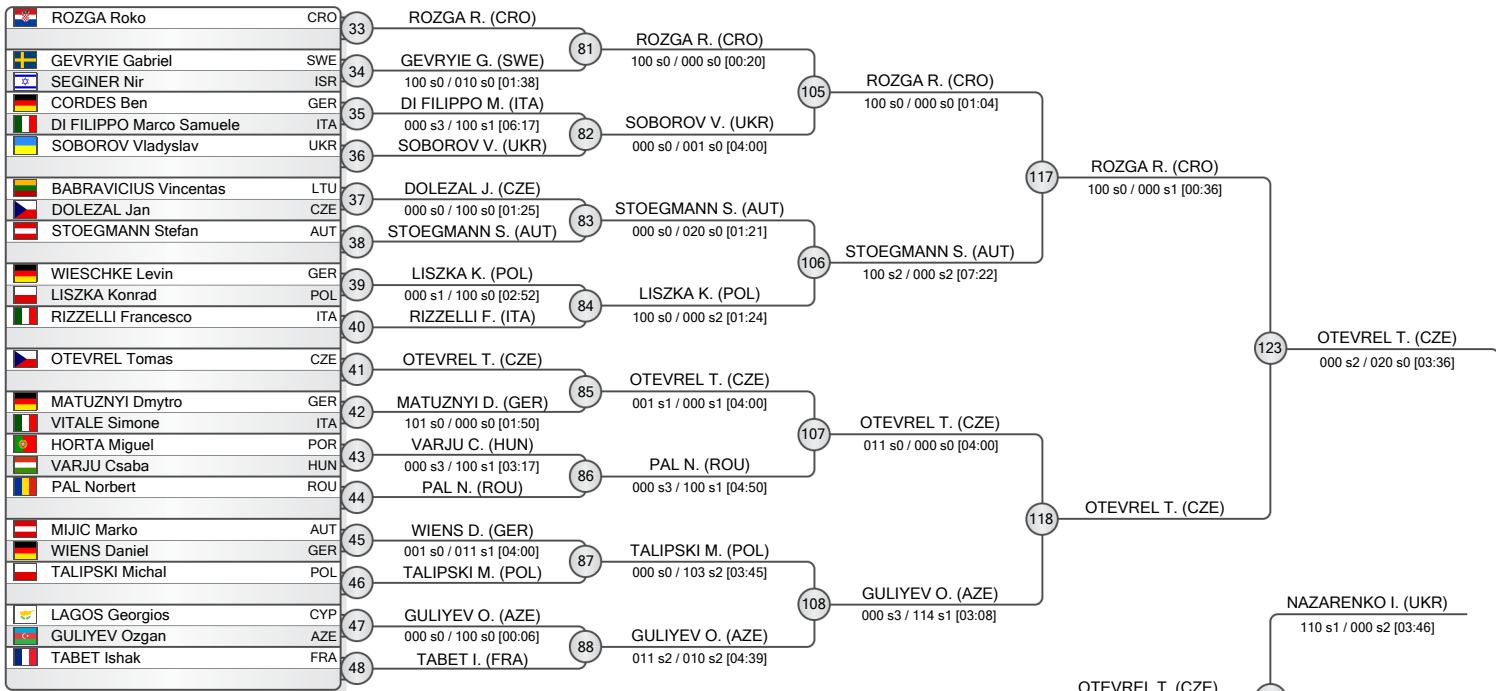

POOL D

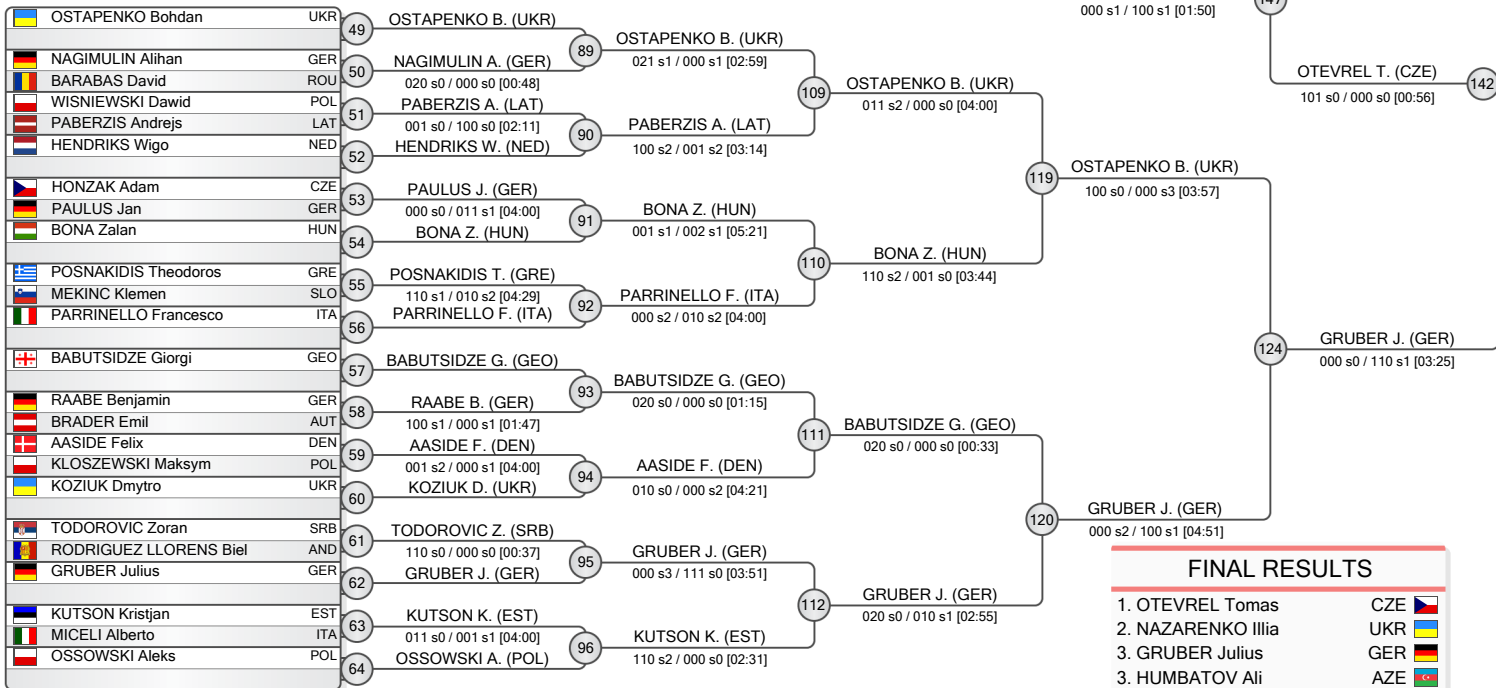

REPECHAGE

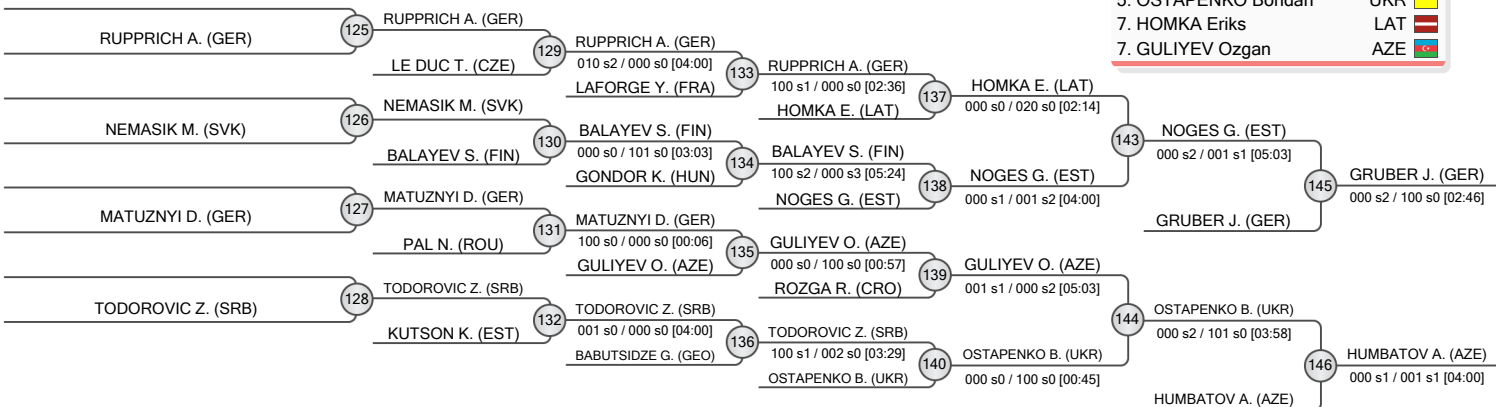



Teplice Millennium Team Cadet European Cup 2025

Czechia, Teplice, 5-6 Apr 2025

-73 kg

Men (80)

POOL A

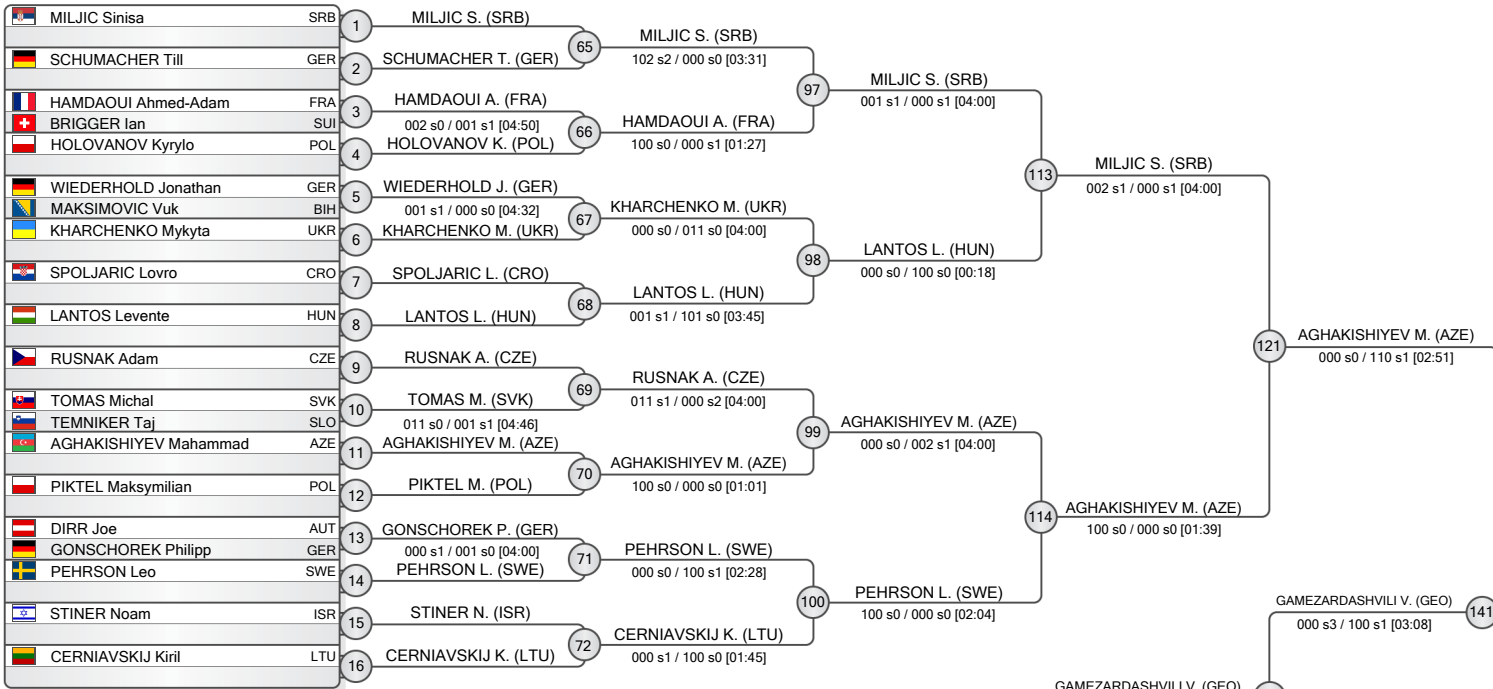

POOL B

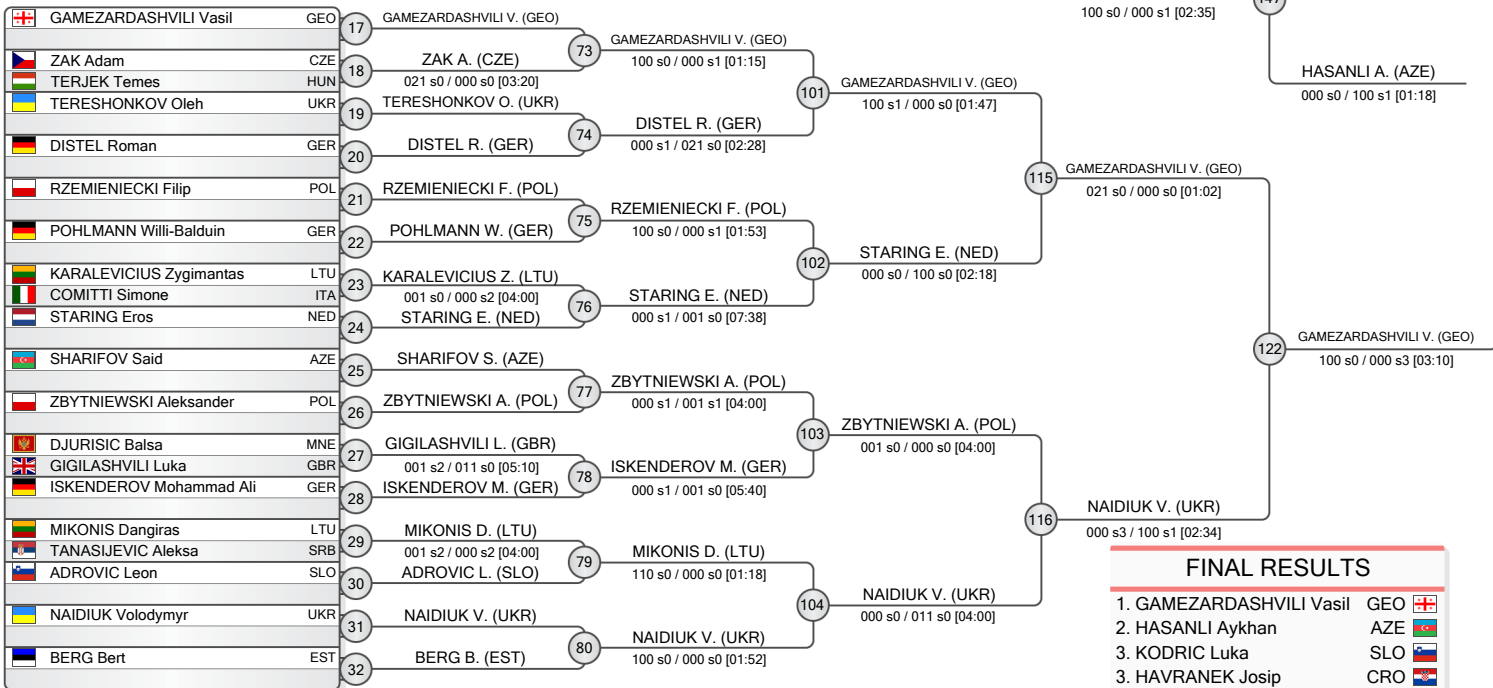

FINAL RESULTS

1. GAMEZARDASHVILI Vasil GEO
2. HASANLI Aykhan AZE
3. KODRIC Luka SLO
4. HAVRANEK Josip CRO
5. MILJIC Sinisa SRB
6. AGHAKISHIYEV Mahammad AZE
7. DISTEL Roman GER
8. KRIVOLAPOV Egor KGZ

REPECHAGE

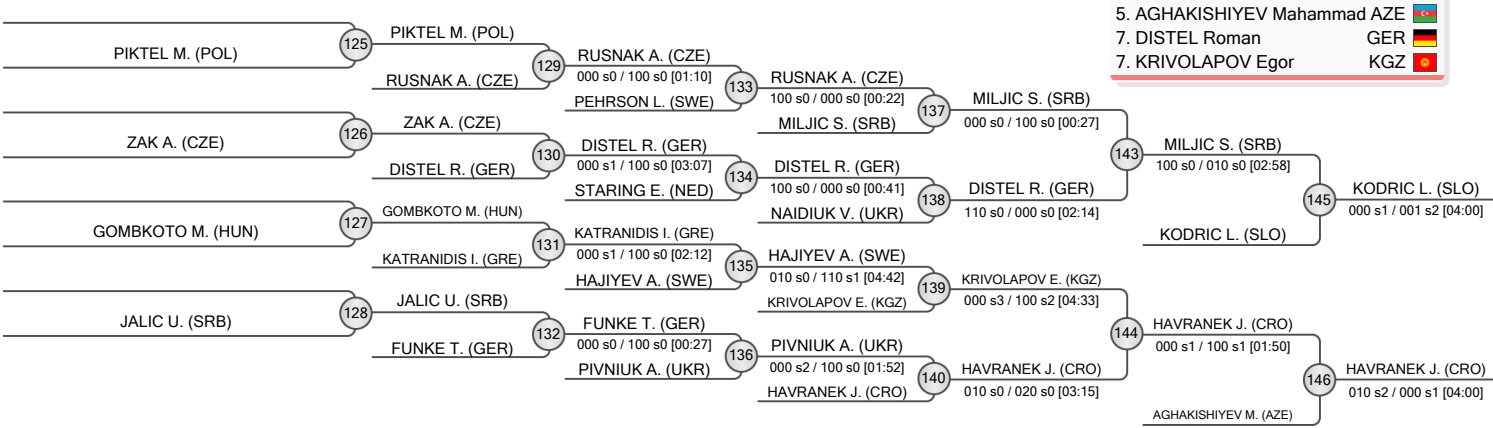



Teplice Millennium Team Cadet European Cup 2025

Czechia, Teplice, 5-6 Apr 2025

-81 kg

Men (59)

POOL A

1	SOLIANYK Mykhailo (UKR)	1	SOLIANYK M. (UKR)
2	VLACH Marek (CZE)	2	VLACH M. (CZE)
3	TCHENDJE KENMEUE Arthur (FRA)	3	FREIRE GONZALEZ N. (ESP)
4	FREIRE GONZALEZ Nicolas (ESP)	4	MAN D. (ROU)
5	ARBULLA Alessandro (ITA)	5	MAN D. (ROU)
6	ADOLPH Jayden (GER)	6	SARBOCH A. (CZE)
7	MAN Darius (ROU)	7	SARBOCH A. (CZE)
8	SARBOCH Adam (CZE)	8	VORONIN M. (POR)
9	SINCHUK Vladyslav (UKR)	9	VORONIN M. (POR)
10	ERLICH Roland (GER)	10	WOERMANSIEDER K. (AUT)
11	VORONIN Maksym (POR)	11	WOERMANSIEDER K. (AUT)
12	WOERMANSIEDER Klaus (AUT)	12	GRAJFONER N. (SLO)
13	CIBUR Michal (SVK)	13	GRAJFONER N. (SLO)
14	ABAKUNOV Petro (POL)	14	
15	GRAJFONER Niko (SLO)	15	

POOL B

9	MUMLADZE Giorgi (GEO)	9	MUMLADZE G. (GEO)
10	BOROJEVIC Veljko (SRB)	10	BOROJEVIC V. (SRB)
11	CHARALAMPOUS Miltiadis (CYP)	11	SEMANJAKU E. (ITA)
12	SEMANJAKU Erik (ITA)	12	ROTAR M. (UKR)
13	AYDIN Arda (TUR)	13	ROTAR M. (UKR)
14	ROJAR Maksym (UKR)	14	MEHDIYEV A. (AZE)
15	BERGLEZ KOS Val (SLO)	15	MEHDIYEV A. (AZE)
16	MEHDIYEV Amin (AZE)	16	VALA L. (CZE)
17	SVALINA Nikola (CRO)	17	VALA L. (CZE)
18	PERECZ Mark (HUN)	18	
19	FENSKI Ole (GER)	19	
20	MARGREITER Simon (AUT)	20	
21	VALA Lukas (CZE)	21	
22	SUPAKHUNOV David (LTU)	22	

POOL C

17	BABAICENKO Tajus (LTU)	17	BABAICENKO T. (LTU)
18	VAN DEN HIL Mathijs (NED)	18	VAN DEN HIL M. (NED)
19	GROSS Tillmann (GER)	19	FICTUM M. (CZE)
20	FILIP Andrei (FRA)	20	FICTUM M. (CZE)
21	FICTUM Martin (CZE)	21	AMARO P. (POR)
22	CUCEREANU Liviu (AUT)	22	BETKOWSKI J. (POL)
23	AMARO Pedro (POR)	23	BETKOWSKI J. (POL)
24	BETKOWSKI Jeremiasz (POL)	24	KERANEN E. (FIN)
25	LOEWEN Musa (GER)	25	KERANEN E. (FIN)
26	MIKLOSVOLGYI Mate (HUN)	26	KOTER T. (SLO)
27	KERANEN Elmo (FIN)	27	ZADNIPRIANETS I. (UKR)
28	IANCU Robert (ROU)	28	ZADNIPRIANETS I. (UKR)
29	KOTER Tjan (SLO)	29	
30	ZUCCHERI Leonardo (ITA)	30	
31	ZADNIPRIANETS Ivan (UKR)	31	

POOL D

25	KULLO Tits (LAT)	25	KULLO T. (LAT)
26	IAKOVOU Michalis (CYP)	26	IAKOVOU M. (CYP)
27	MARACHEV Pylyp (UKR)	27	SCHEIBER F. (AUT)
28	SCHEIBER Felix (AUT)	28	SCHEIBER F. (AUT)
29	MATTSSON Wilmer (SWE)	29	LECHOWICZ M. (POL)
30	LECHOWICZ Marek (POL)	30	BLASE Theodor (GER)
31	BLASE Theodor (GER)	31	RAHMATOV A. (AZE)
32	RAHMATOV Abdullah (AZE)	32	RAHMATOV A. (AZE)
33	KOVSE Marko (SLO)	33	KLIMES V. (CZE)
34	ANESASVILI Vartno (GER)	34	KLIMES V. (CZE)
35	KLIMES Vojtech (CZE)	35	SIGNORINI N. (ITA)
36	MANDIC Veljko (SRB)	36	SIGNORINI N. (ITA)
37	SIGNORINI Nicolo (ITA)	37	SAKHAROV N. (UKR)
38	KARAKLIDIS Gkiorgki (GRE)	38	SAKHAROV N. (UKR)
39	SAKHAROV Nikita (UKR)	39	

REPECHAGE

61	VLACH M. (CZE)	61	VLACH M. (CZE)
62	BOROJEVIC V. (SRB)	62	BOROJEVIC V. (SRB)
63	VAN DEN HIL M. (NED)	63	VAN DEN HIL M. (NED)
64	SIGNORINI N. (ITA)	64	SIGNORINI N. (ITA)
65	MAN D. (ROU)	65	MAN D. (ROU)
66	ROTAR M. (UKR)	66	ROTAR M. (UKR)
67	FICTUM M. (CZE)	67	FICTUM M. (CZE)
68	RAHMATOV A. (AZE)	68	RAHMATOV A. (AZE)
69	SARBOCH A. (CZE)	69	SARBOCH A. (CZE)
70	MEHDIYEV A. (AZE)	70	MEHDIYEV A. (AZE)
71	ZADNIPRIANETS I. (UKR)	71	ZADNIPRIANETS I. (UKR)
72	RAHMATOV A. (AZE)	72	RAHMATOV A. (AZE)
73	MUMLADZE G. (GEO)	73	MUMLADZE G. (GEO)
74	BABAICENKO T. (LTU)	74	BABAICENKO T. (LTU)
75	SARBOCH A. (CZE)	75	SARBOCH A. (CZE)
76	RAHMATOV A. (AZE)	76	RAHMATOV A. (AZE)
77	SAKHAROV N. (UKR)	77	SAKHAROV N. (UKR)
78	SOLIANYK M. (UKR)	78	SOLIANYK M. (UKR)

FINAL RESULTS

- MUMLADZE Giorgi (GEO)
- BABAICENKO Tajus (LTU)
- SAKHAROV Nikita (UKR)
- SOLIANYK Mykhailo (UKR)
- SARBOCH Adam (CZE)
- RAHMATOV Abdullah (AZE)
- MEHDIYEV Amin (AZE)
- ZADNIPRIANETS Ivan (UKR)





Teplice Millennium Team Cadet European Cup 2025

Czechia, Teplice, 5-6 Apr 2025

+ 90 kg

Men (32)

POOL A

	AKHUNDOV Subhan	AZE
	LOFLING Pontus	SWE
	FRANGEZ Gal	SLO
	APSALONS Aleksandrs	LAT
	DEKENNE DIFFO Azriel	FRA
	NAZARCHUK Daniil	UKR
	BRUNNER Jan	CZE
	PALEICIKAS Nikolas	LTU

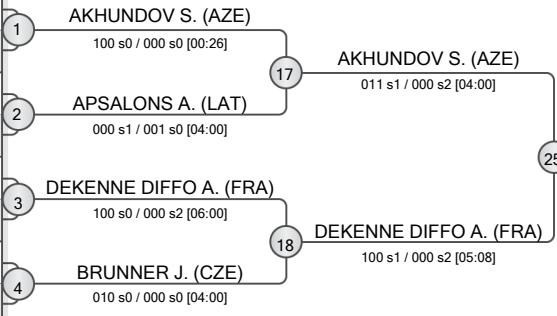

POOL B

	CSERMAK Daniel	HUN
	BISCHOFF Samuel	GER
	ZHADAN Serhii	UKR
	LABATE Federico	ITA
	ABALAKI Ioane	GEO
	NOVOTNY Jaroslav	CZE
	FLORENCIA Giovanni	NED
	TAURA Patrikas	LTU

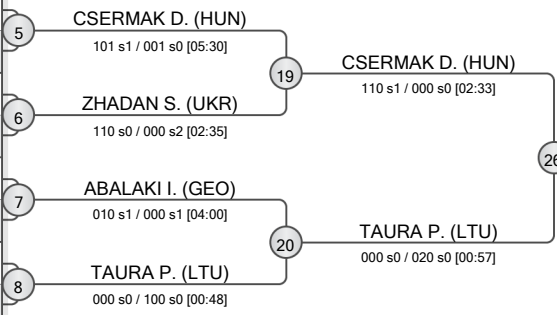

POOL C

	NOVAKOVIC Petar	SRB
	GURSKIJ Gabriel	LTU
	TEGELAAR Jack	SWE
	ANGERER Lukas	AUT
	SKODA Melichar	CZE
	HUBKO Yehor	UKR
	CUIBUS Raul	ROU
	FARZALIYEV Tunar	AZE

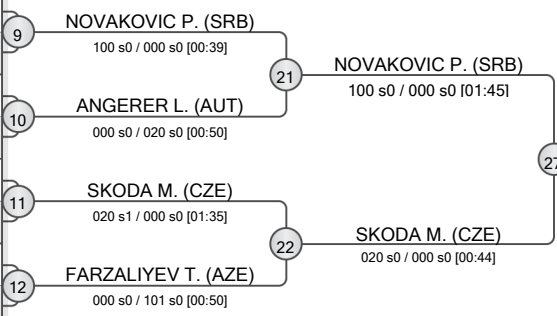

POOL D

	KARCHAIDZE Giorgi	GEO
	BEGIC Ivan	GER
	ELUARD Aaron	FRA
	TRUHLAR Martin	CZE
	SZEKERES Abel	HUN
	JESUS Miguel	POR
	KAMINSKI Dawid	POL
	TIUKH Yurii	UKR

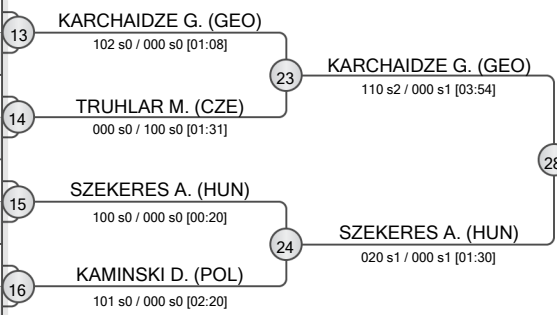

REPECHAGE

LOFLING P. (SWE)	29	APSALONS A. (LAT)	33
APSALONS A. (LAT)		DEKENNE DIFFO A. (FRA)	
BISCHOFF S. (GER)		ZHADAN S. (UKR)	34
ZHADAN S. (UKR)	30	TAURA P. (LTU)	
HUBKO Y. (UKR)		FARZALIYEV T. (AZE)	35
FARZALIYEV T. (AZE)	31	NOVAKOVIC P. (SRB)	
BEGIC I. (GER)		TRUHLAR M. (CZE)	36
TRUHLAR M. (CZE)	32	SZEKERES A. (HUN)	

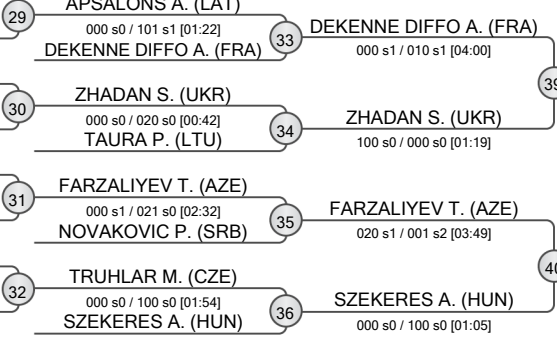

FINAL RESULTS	
1. SKODA Melichar	CZE
2. AKHUNDOV Subhan	AZE
3. DEKENNE DIFFO Azriel	FRA
3. CSERMAK Daniel	HUN
5. KARCHAIDZE Giorgi	GEO
5. SZEKERES Abel	HUN
7. ZHADAN Serhii	UKR
7. FARZALIYEV Tunar	AZE





Teplice Millennium Team Cadet European Cup 2025

Czechia, Teplice, 5-6 Apr 2025

-40 kg

Women (12)

POOL A

	COSKUN Busra Ceylin	TUR
	HRYHORENKO Anna	UKR
	MARIAN Daria	ROU

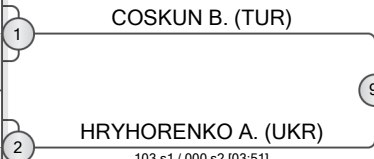

POOL B

	PALAMARENKO Sofia	UKR
	HUSEYNOVA Madina	AZE
	GRACOVA Dominika	CZE

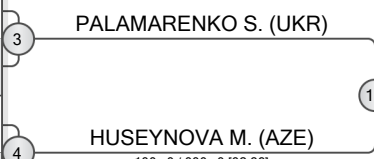

POOL C

	DA COSTA Clelia	FRA
	LAVERGNE Joanne	FRA
	CIUMAS Bianca	ROU

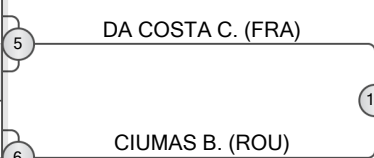

POOL D

	YILMAZTURK Yagmur	TUR
	LIETI Alice	ITA
	TAKACS Nora	HUN

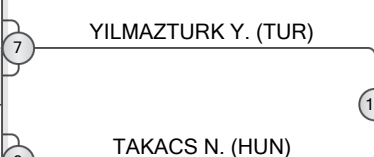

REPECHAGE

HRYHORENKO A. (UKR)	13	HRYHORENKO A. (UKR)
HUSEYNOVA M. (AZE)	14	HUSEYNOVA M. (AZE)
LAVERGNE J. (FRA)	15	DA COSTA C. (FRA)
DA COSTA C. (FRA)	15	DA COSTA C. (FRA)
TAKACS N. (HUN)	16	TAKACS N. (HUN)

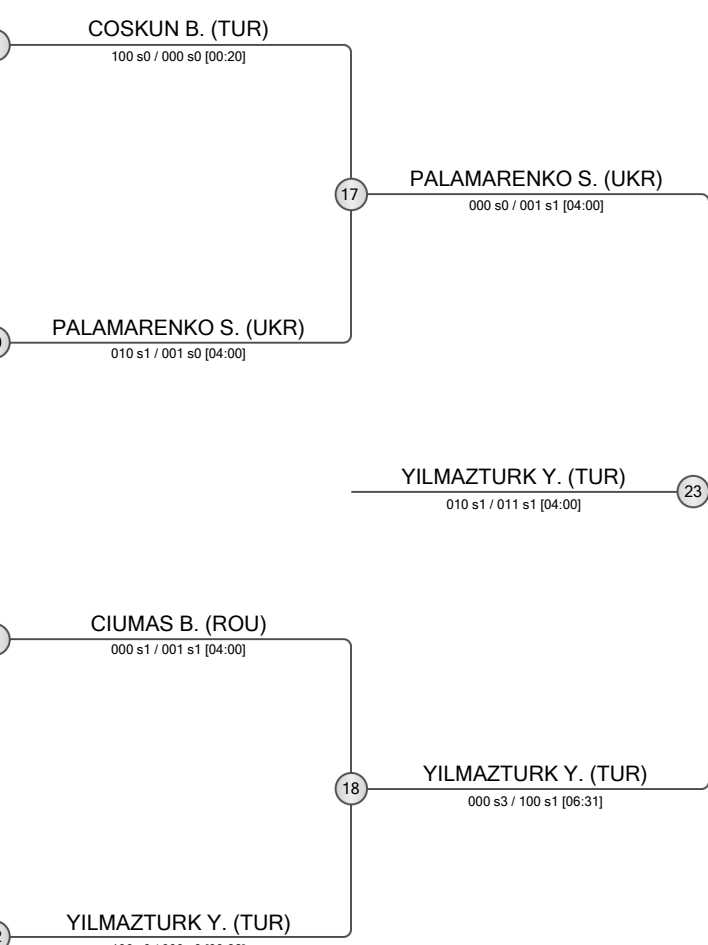
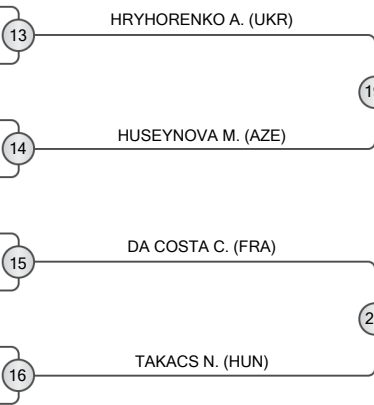

FINAL RESULTS

1.	YILMAZTURK Yagmur	TUR	
2.	PALAMARENKO Sofia	UKR	
3.	HUSEYNOVA Madina	AZE	
3.	COSKUN Busra Ceylin	TUR	
5.	CIUMAS Bianca	ROU	
5.	TAKACS Nora	HUN	
7.	HRYHORENKO Anna	UKR	
7.	DA COSTA Clelia	FRA	





Teplice Millennium Team Cadet European Cup 2025

Czechia, Teplice, 5-6 Apr 2025

-44 kg

Women (26)

POOL A

	SERBAN Denisa	ROU
	DUDAS Regina	HUN
	MARTIN TORRES Jimena	ESP
	BLASZCZYK Julia	POL
	HUSEYNOVA Gulshan	AZE
	STORIONE Ludovica	ITA
	SEGURA Chloe	FRA

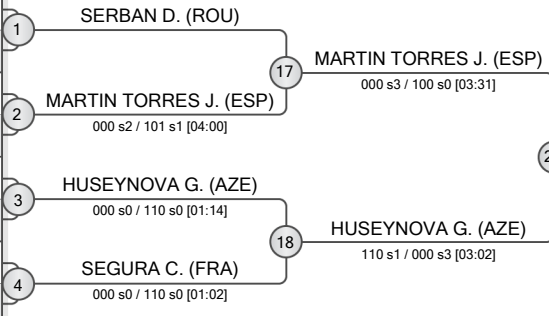

POOL B

	TIGANOV Cristina	ITA
	CUSA Carla	ROU
	GASPAR Matilde	POR
	GORANOVIC Katarina	SRB
	HLUSHCHENKO Tetiana	UKR
	ABDULLAYEVA Fatima	AZE

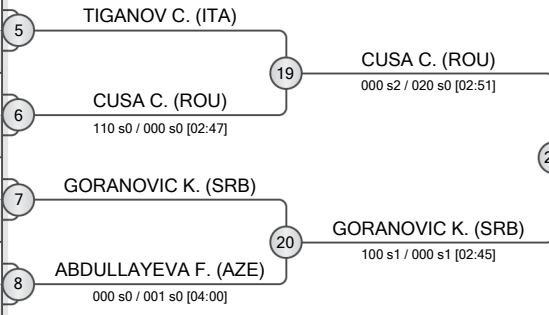

POOL C

	KAYIR Livanur	TUR
	SZCZEPANSKA Julia	POL
	ZVAJKEK Sara	SLO
	SPONSELEE Mare	NED
	TANASE Abigail	ROU
	PECHORINA Yeva	UKR
	FERRO Aurora	ITA

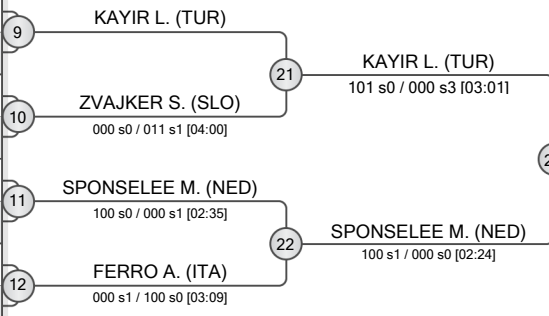

POOL D

	AUREL Mathilde	FRA
	LONGO Sofia	ITA
	BAHAMONDE GARCIA Elena	ESP
	ABDULLAYEVA Khadija	AZE
	SILVA Noa	POR
	RIEZNIC Vladyslava	UKR

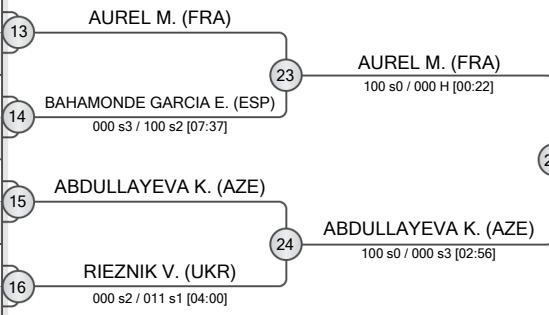

FINAL RESULTS	
1.	AUREL Mathilde
2.	HUSEYNOVA Gulshan
3.	SPONSELEE Mare
3.	KAYIR Livanur
5.	GORANOVIC Katarina
7.	MARTIN TORRES Jimena
7.	ABDULLAYEVA Khadija

REPECHAGE

BLASZCZYK J. (POL)	BLASZCZYK J. (POL)	33
SEGURA C. (FRA)	MARTIN TORRES J. (ESP)	33
GASPAR M. (POR)	TIGANOV C. (ITA)	34
TIGANOV C. (ITA)	GORANOVIC K. (SRB)	34
TANASE A. (ROU)	FERRO A. (ITA)	35
FERRO A. (ITA)	KAYIR L. (TUR)	35
BAHAMONDE GARCIA E. (ESP)	ABDULLAYEVA K. (AZE)	36
ABDULLAYEVA K. (AZE)	ABDULLAYEVA K. (AZE)	36

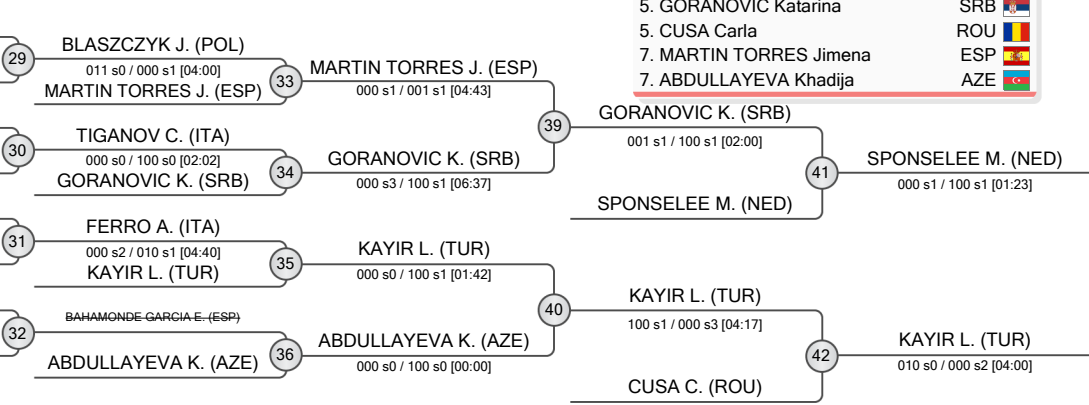



Teplice Millennium Team Cadet European Cup 2025

Czechia, Teplice, 5-6 Apr 2025

-48 kg

Women (41)

POOL A

	KISS Viktoria	HUN	1	KISS V. (HUN)
	TRAMPITSCH Maja	AUT	2	TRAMPITSCH M. (AUT)
	MONTALBANO Aurora	ITA	3	MONTALBANO A. (ITA)
	FALDT Lova	SWE	4	FALDT L. (SWE)
	ALAKBAROVA Leyla	AZE	4	ALAKBAROVA L. (AZE)
	BRONZIN Alice	ITA	5	BRONZIN A. (ITA)
	FERTIG Maya	GER	6	FERTIG M. (GER)
	SIELSKA Zuzanna	POL	7	BOSKUP A. (TUR)
	BOSKUP Aysenur	TUR	7	BOSKUP A. (TUR)
	PRITULEAC Iana	MDA	8	PRITULEAC I. (MDA)

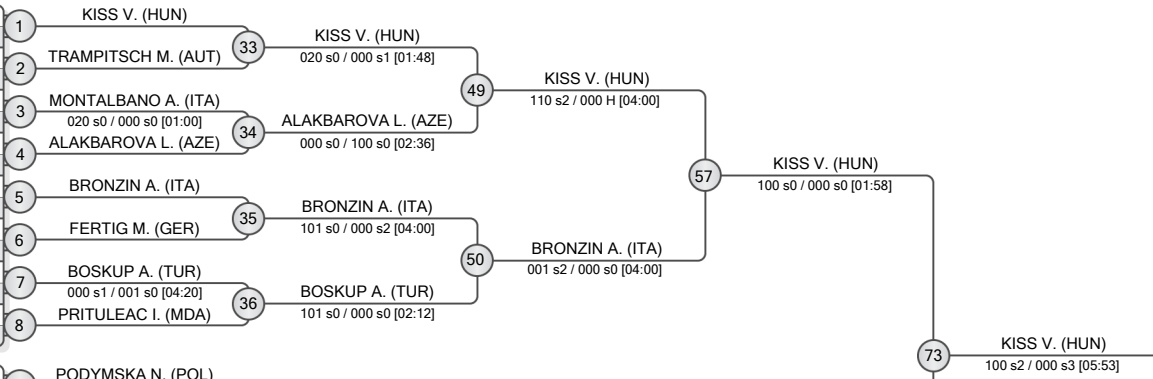

POOL B

	PODYMSKA Nina	POL	9	PODYMSKA N. (POL)
	MATEJKOVA Teresa	SVK	10	IDDIR C. (FRA)
	IDDIR Celine	FRA	10	IDDIR C. (FRA)
	MAYRHOFER Lena	AUT	11	MAYRHOFER L. (AUT)
	LIETI Sofia	ITA	12	MAYRHOFER L. (AUT)
	AHMADOVA Nargiz	AZE	12	AHMADOVA N. (AZE)
	CHRISP Taylor	GBR	13	CHRISP T. (GBR)
	HENDRIKS Tess	NED	14	RASIC M. (SRB)
	RASIC Mara	SRB	14	RASIC M. (SRB)
	MUNTEANU Ana Maria	ROU	15	MUNTEANU A. (ROU)
	SOARES Maria	POR	16	MUNTEANU A. (ROU)

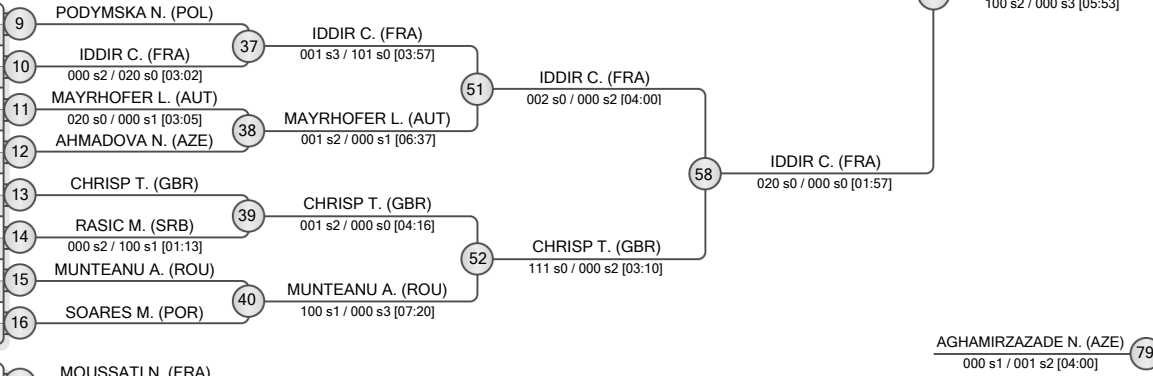

POOL C

	MOUSSATI Nourane	FRA	17	MOUSSATI N. (FRA)
	PAPAI Stella	HUN	18	PIELOCH O. (POL)
	PIELOCH Oliwia	POL	18	PIELOCH O. (POL)
	ARTEAGA Evelin	SWE	19	ARTEAGA E. (SWE)
	PULJIC Lucija	CRO	20	PULJIC L. (CRO)
	EYVAZLI Konul	AZE	21	EYVAZLI K. (AZE)
	NEDVYHA Yaroslava	UKR	22	NEDVYHA Y. (UKR)
	IVALDI Beatrice	ITA	23	MERKVLADZE S. (GEO)
	MERKVLADZE Salome	GEO	23	MERKVLADZE S. (GEO)
	GANGL Anna	AUT	24	GANGL A. (AUT)

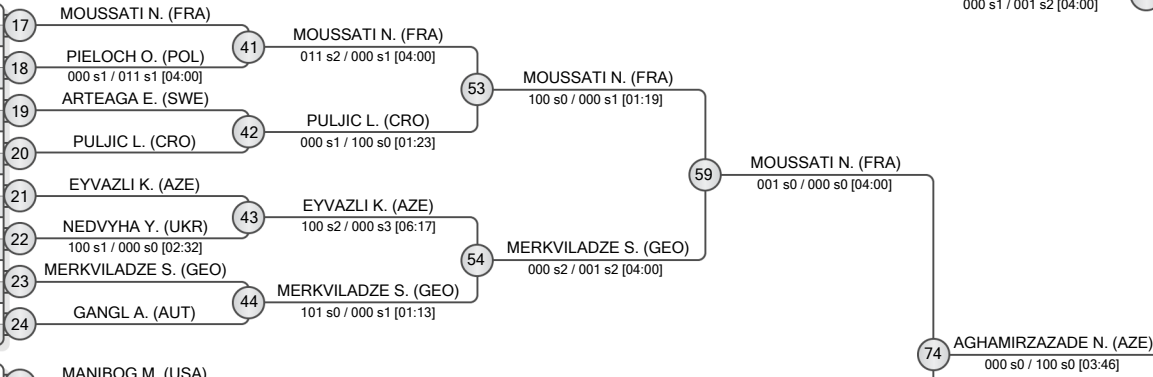

POOL D

	MANIBOG Malia	USA	25	MANIBOG M. (USA)
	SOSA LAVANDEIRA Zeltia	ESP	26	AGHAMIRZAZADE N. (AZE)
	AGHAMIRZAZADE Narmin	AZE	26	AGHAMIRZAZADE N. (AZE)
	ALOISE Ginevra	ITA	27	ALOISE G. (ITA)
	PLICH Emily Chiara	GER	28	PLICH E. (GER)
	PEREIRA Mariana	POR	29	PEREIRA M. (POR)
	OANCEA Irina	ROU	30	MANTYKENTTA S. (FIN)
	MANTYKENTTA Sara	FIN	30	MANTYKENTTA S. (FIN)
	STOLLAROVA Sofia	SVK	31	STOLLAROVA S. (SVK)
	CZERWINSKA-KOWAR Karina	POL	32	CZERWINSKA-KOWAR K. (POL)

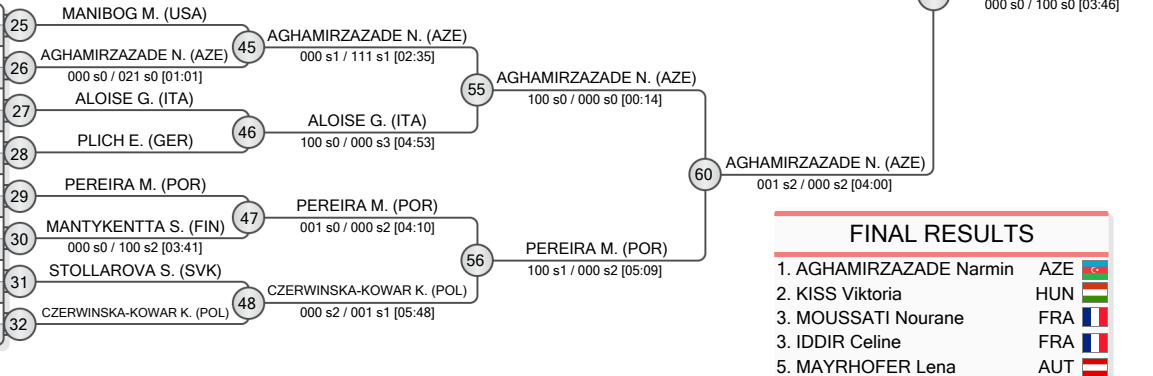

1.	AGHAMIRZAZADE Narmin	AZE	
2.	KISS Viktoria	HUN	
3.	MOUSSATI Nourane	FRA	
5.	MAYRHOFER Lena	AUT	
7.	MERKVLADZE Salome	GEO	
7.	BRONZIN Alice	ITA	
7.	MANIBOG Malia	USA	

REPECHAGE

	TRAMPITSCH M. (AUT)	61	TRAMPITSCH M. (AUT)
	MATEJKOVA T. (SVK)	62	ALAKBAROVA L. (AZE)
	PODYMSKA N. (POL)	62	PODYMSKA N. (POL)
	PIELOCH O. (POL)	63	PIELOCH O. (POL)
	MANIBOG M. (USA)	64	MANIBOG M. (USA)

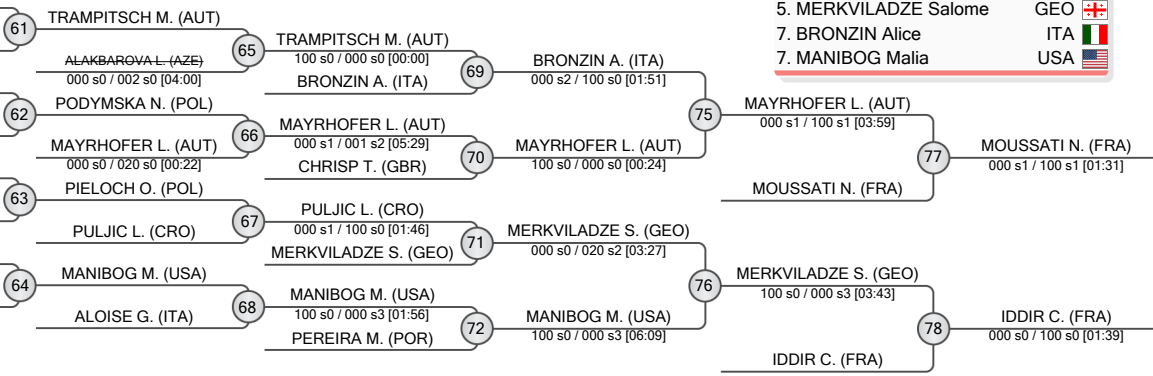



Teplice Millennium Team Cadet European Cup 2025

Czechia, Teplice, 5-6 Apr 2025

-52 kg

Women (44)

POOL A

	VAS Mira	HUN
	HELCELETOVA Lilly Sofie	CZE
	VADOVICOVA Vivien	SVK
	GLAUNER Hannah	GER
	GUION Sofia	ITA
	STOJANOV Lenka	SRB
	MONNEY Lya	SUI
	LEMM Emilia	GER
	LAHRIFI Lalla-Dounia	FRA
	ZIVKOVIC Valentina	CRO
	KYRYLCHUK Kseniia	UKR

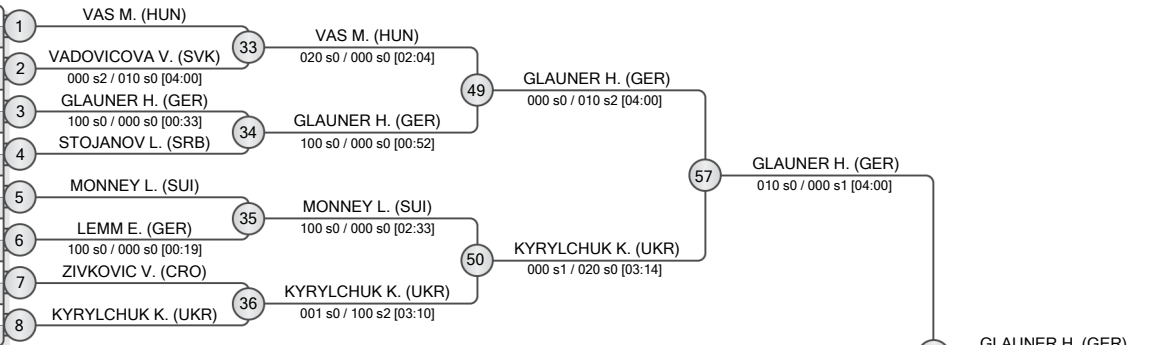

POOL B

	YEMELIANOVA Yelyzaveta	UKR
	JIRASKOVA Darina	CZE
	MAJEWSKA Julia	POL
	TEISANU Teodora	ROU
	SAS-ZALOZIECKI Valerie	AUT
	GOTTFRIED Eleonora	GER
	HAMDAOUI Dina-Syrine	FRA
	XAVIER Maria	POR
	ECKARDT Marissa	GER
	SCHMITZ Lotus	NED
	URBANOVA Natalie	CZE

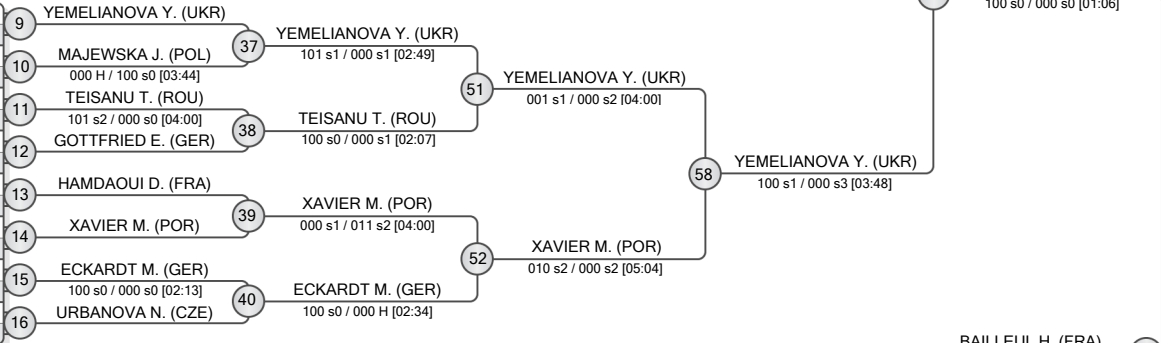

POOL C

	MOS Marika	POL
	GREGOR Stefanie	GER
	GALHARDAS Francisca	POR
	PAJERICH Anna	HUN
	TUCAJ Martina	CRO
	KARNA Olivia	FIN
	ZARUBA Viktorija	LTU
	GUETH Sarah	GER
	BABAYEVA Tovsiyya	AZE
	POSPISILOVA Adela	CZE
	NIUTTA Sofia	ITA

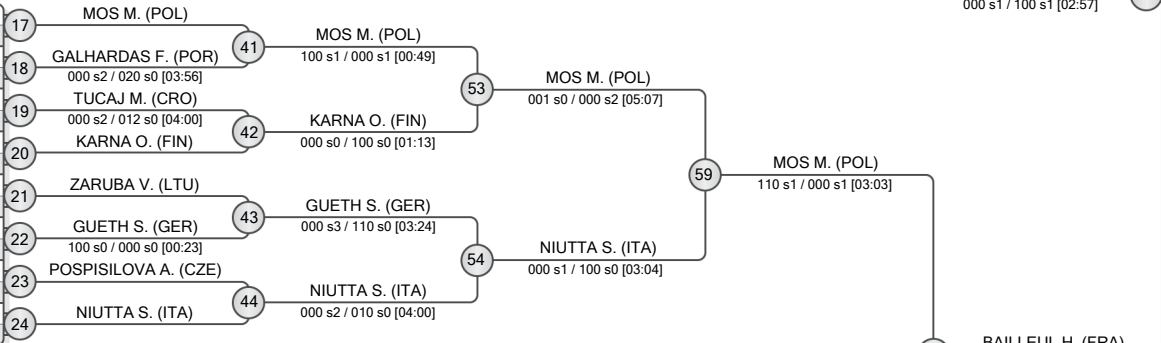

POOL D

	CORDOVA Sofia	SWE
	TUMKO Polina	UKR
	VAN DER KAMP Quinn	NED
	WOERNER Daphne	GER
	HAVLICKOVA Tereza	CZE
	SLOTH HANSEN Alice	DEN
	DI LEONARDO Noemi	ITA
	WAMHOF Matilda	GER
	OZDIL Aysenur	TUR
	BAILLEUL Helea	FRA
	GASPAR Sofia	POR

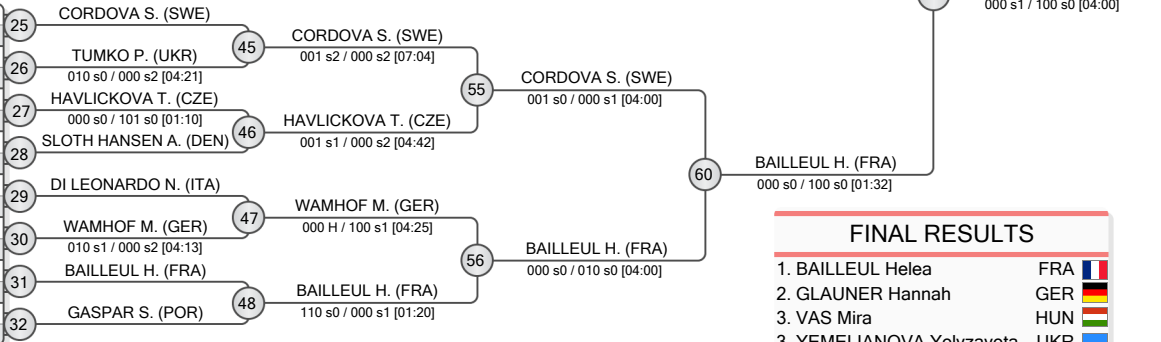

FINAL RESULTS		
1.	BAILLEUL Helea	
2.	GLAUNER Hannah	
3.	VAS Mira	
3.	YEMELIANOVA Yelyzaveta	
5.	MOS Marika	
5.	CORDOVA Sofia	
7.	XAVIER Maria	
7.	NIUTTA Sofia	

REPECHAGE

GUION S. (ITA)	61	STOJANOV L. (SRB)	61	STOJANOV L. (SRB)	65	VAS M. (HUN)	65	VAS M. (HUN)	69	VAS M. (HUN)	75	VAS M. (HUN)	75	VAS M. (HUN)	77	VAS M. (HUN)	77
STOJANOV L. (SRB)	61	VAS M. (HUN)	65	KYRYLCHUK K. (UKR)	66	MAJEWSKA J. (POL)	66	MAJEWSKA J. (POL)	70	XAVIER M. (POR)	70	XAVIER M. (POR)	70	XAVIER M. (POR)	77	VAS M. (HUN)	77
MAJEWSKA J. (POL)	62	TEISANU T. (ROU)	66	XAVIER M. (POR)	67	GALHARDAS F. (POR)	67	KARNA O. (FIN)	67	KARNA O. (FIN)	71	NIUTTA S. (ITA)	71	NIUTTA S. (ITA)	76	CORDOVA S. (SWE)	76
GALHARDAS F. (POR)	63	KARNA O. (FIN)	67	NIUTTA S. (ITA)	68	GASPAR S. (POR)	68	WAMHOF M. (GER)	68	WAMHOF M. (GER)	72	CORDOVA S. (SWE)	72	CORDOVA S. (SWE)	76	CORDOVA S. (SWE)	78
GASPAR S. (POR)	64	WAMHOF M. (GER)	68	CORDOVA S. (SWE)	68	WAMHOF M. (GER)	68	CORDOVA S. (SWE)	72	CORDOVA S. (SWE)	72	CORDOVA S. (SWE)	72	YEMELIANOVA Y. (UKR)	78	YEMELIANOVA Y. (UKR)	78

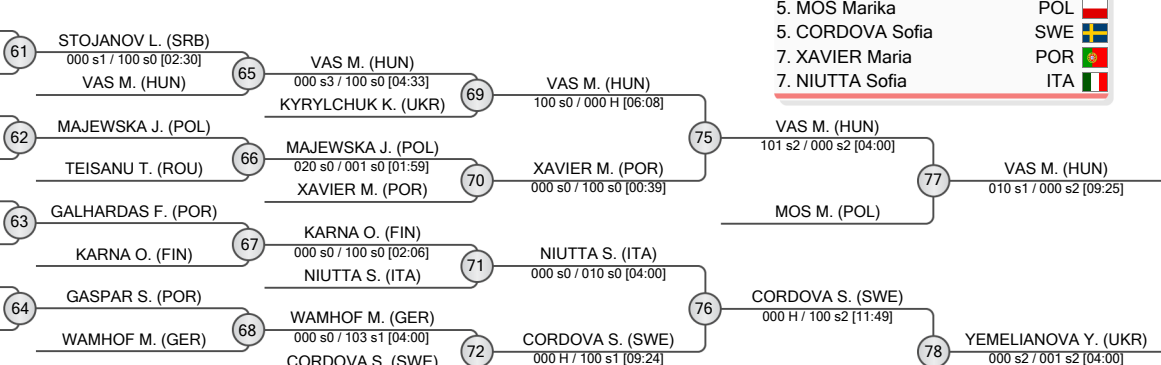



Teplice Millennium Team Cadet European Cup 2025

Czechia, Teplice, 5-6 Apr 2025

-57 kg

Women (81)

POOL A

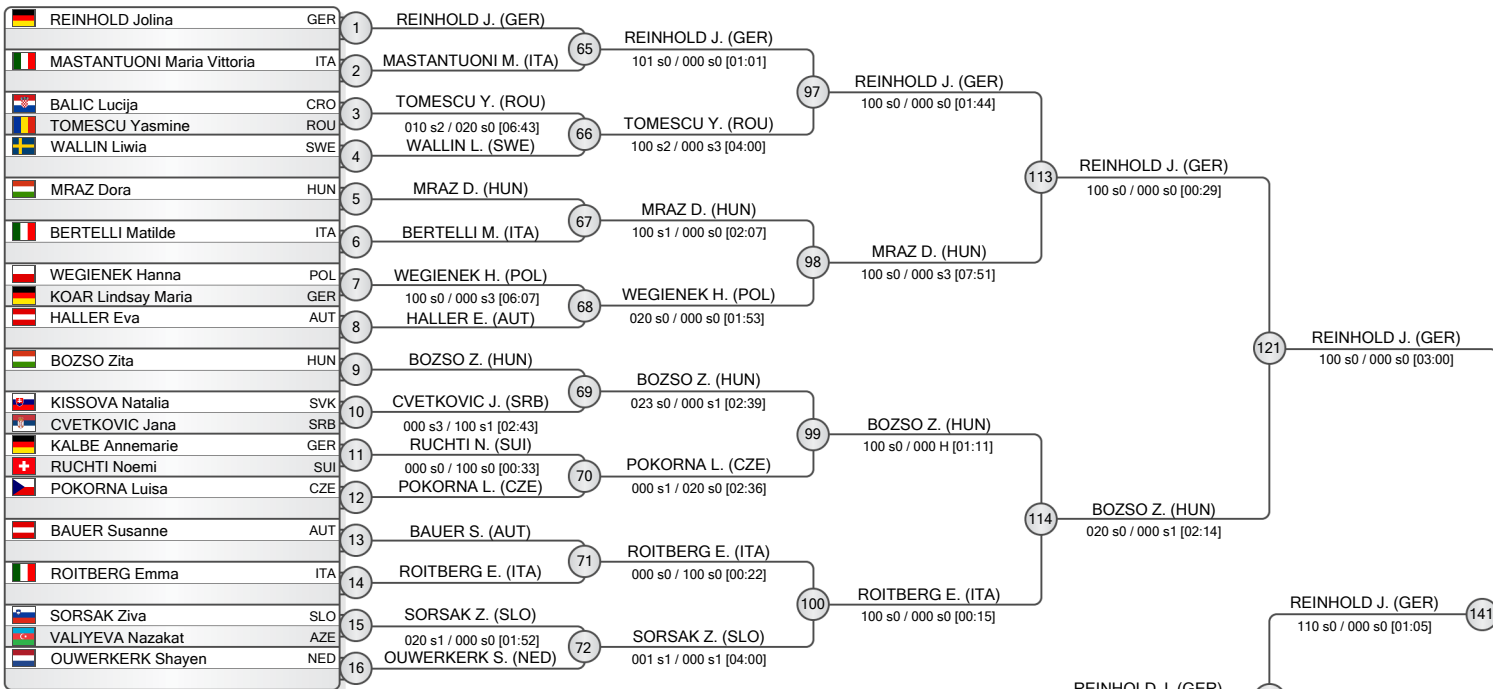

POOL B

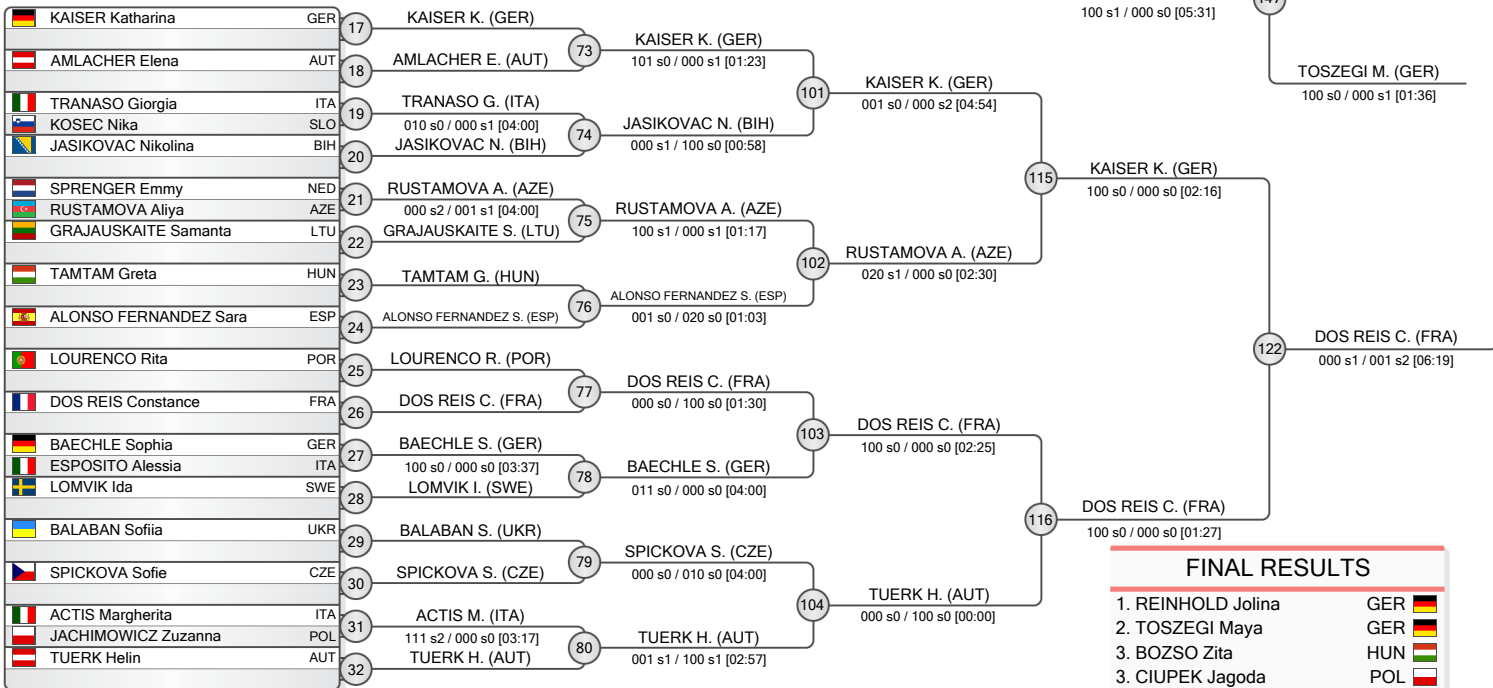

FINAL RESULTS	
1.	REINHOLD Jolina GER
2.	TOSZEGI Maya GER
3.	BOZSO Zita HUN
3.	CIUPEK Jagoda POL
5.	SIEMKO Julia POL
5.	DOS REIS Constance FRA
7.	KAISER Katharina GER
7.	VEINHANDL OBAID Haya SLO

REPECHAGE

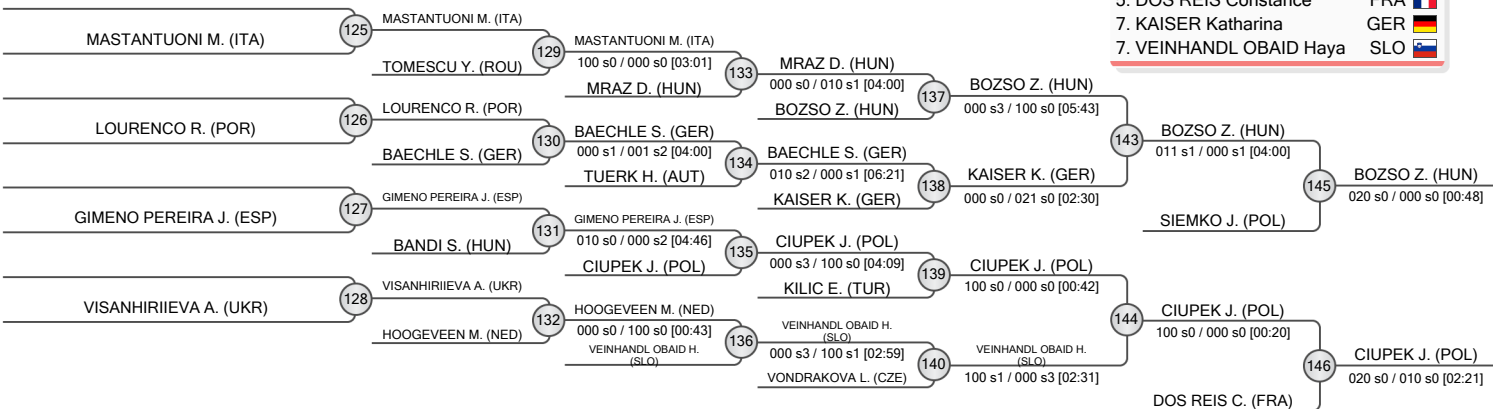



Teplice Millennium Team Cadet European Cup 2025

Czechia, Teplice, 5-6 Apr 2025

-57 kg

Women (81)

POOL C

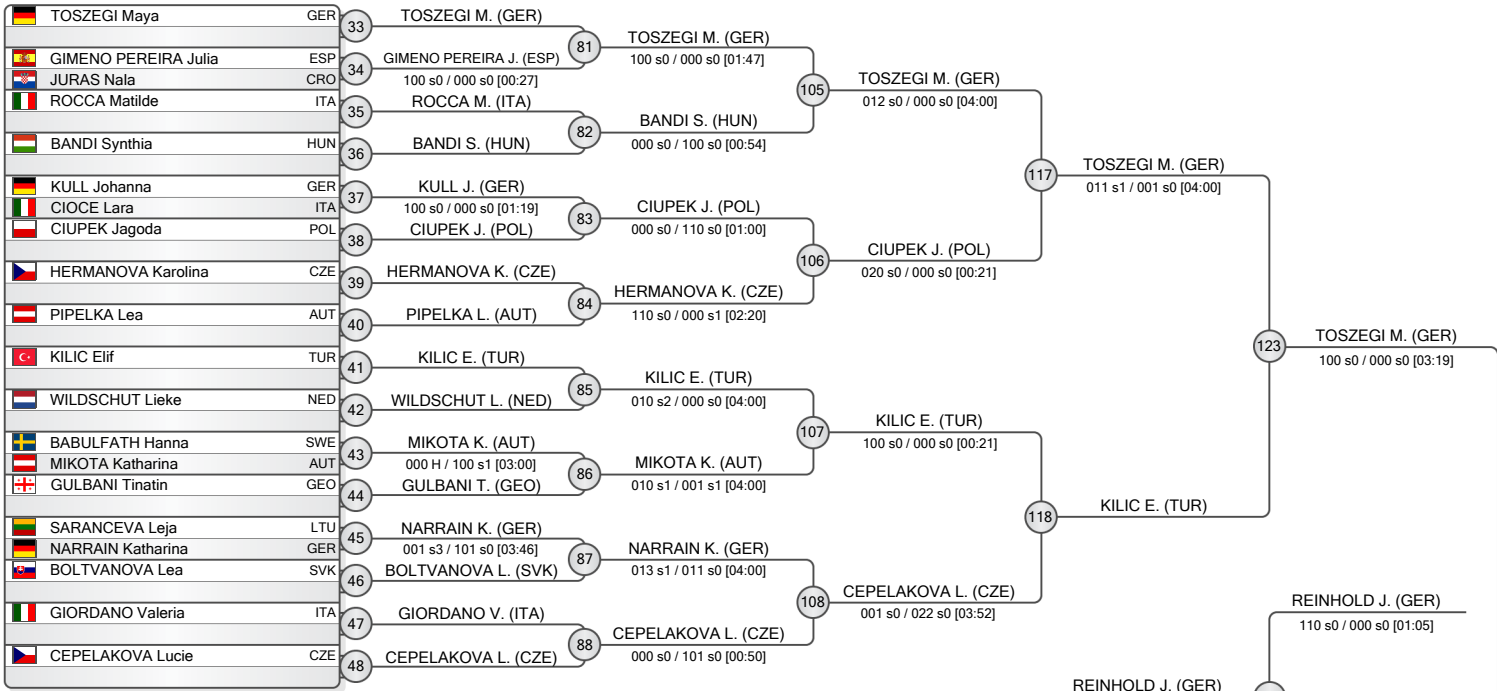

POOL D

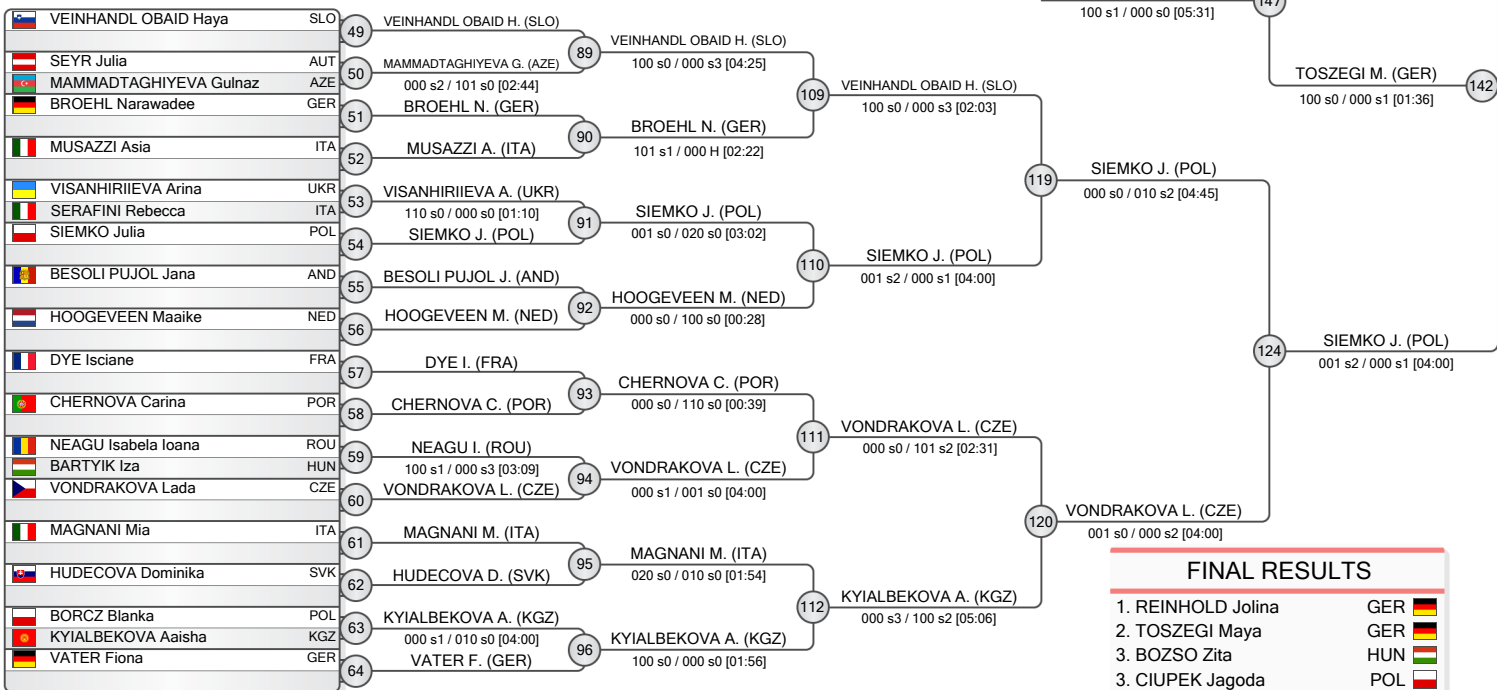

FINAL RESULTS

1. REINHOLD Jolinda GER
2. TOSZEGI Maya GER
3. BOZSO Zita HUN
3. CIUPEK Jagoda POL
5. SIEMKO Julia POL
5. DOS REIS Constance FRA
7. KAISER Katharina GER
7. VEINHANDL OBAID Haya SLO

REPECHAGE

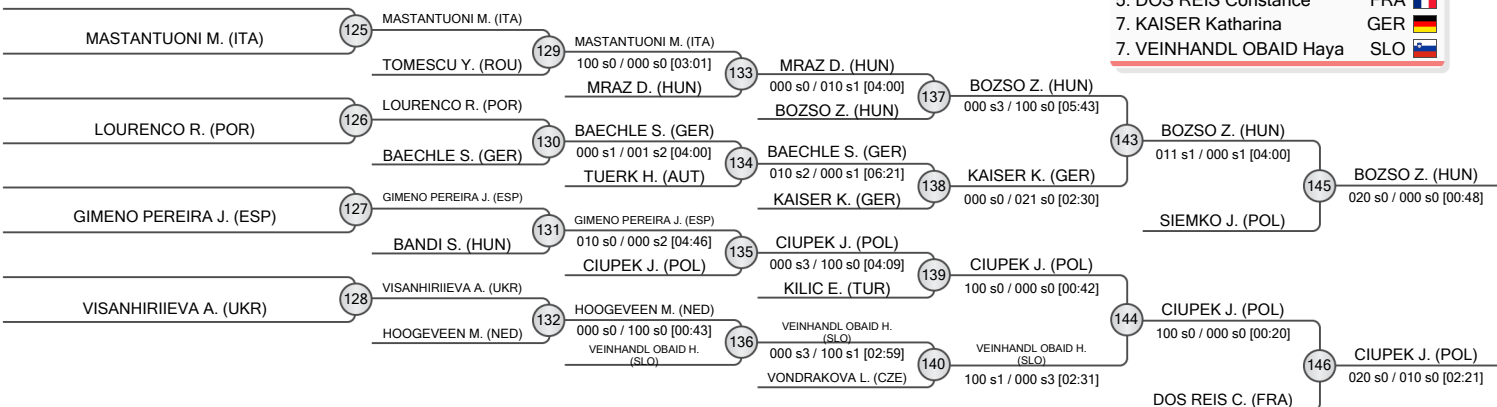



Teplice Millennium Team Cadet European Cup 2025

Czechia, Teplice, 5-6 Apr 2025

-63 kg

Women (64)

POOL A

1	TSURKAN Ilariia (UKR)	100 s0 / 000 s0 [00:34]	33	TSURKAN I. (UKR)	020 s0 / 000 s0 [00:29]
2	ADAMACHI Maya (ROU)	010 s0 / 000 s1 [04:00]			
3	WENDT Lena (GER)	020 s0 / 000 s0 [03:51]	34	WENDT L. (GER)	110 s0 / 000 s1 [01:54]
4	SISKOVA Stela (CZE)	000 s0 / 020 s0 [01:36]			
5	GUENNEUGUES Audren (FRA)	020 s0 / 000 s0 [00:59]	35	KOMODOWSKI I. (DEN)	000 s0 / 020 s0 [01:27]
6	KOMODOWSKI Ingrid (DEN)	000 s1 / 100 s0 [03:04]			
7	AKOPJAN Adele (GER)	000 s0 / 100 s0 [00:30]	36	JANCIKOVA M. (CZE)	000 s3 / 100 s1 [05:34]
8	JANCIKOVA Monika (CZE)	000 s0 / 020 s0 [01:18]			

POOL B

9	SADILKOVA Zuzana (CZE)	110 s1 / 001 s0 [03:27]	37	CAVAGLIA M. (ITA)	000 s0 / 010 s0 [04:00]
10	ALIYEVA Ayan (AZE)	000 s3 / 100 s1 [04:38]			
11	FELDHaus Tabea (GER)	000 s0 / 110 s1 [03:02]	38	SELAN P. (SLO)	000 s0 / 100 s0 [00:49]
12	SELAN Paulina (SLO)	101 s0 / 000 s0 [02:29]			
13	PAVLOVIC Nevena (SRB)	100 s0 / 000 s0 [01:19]	39	PAVLOVIC N. (SRB)	100 s0 / 000 s1 [00:40]
14	KULIKAUSKAITE Meida (LTU)	000 s3 / 100 s0 [04:47]			
15	POKLOPOVA Lucie (CZE)	010 s2 / 000 s2 [05:24]	40	POKLOPOVA L. (CZE)	100 s2 / 000 s3 [08:27]
16	STOCK Luisa (GER)	100 s0 / 000 s0 [01:18]			

POOL C

17	FROSONI Giorgia (ITA)	101 s0 / 000 s0 [00:56]	41	FROSONI G. (ITA)	110 s0 / 000 s3 [03:24]
18	JARCEVA Jekaterina (LTU)	000 s0 / 011 s0 [04:00]			
19	RYBICKA Agata (POL)	010 s1 / 100 s1 [01:37]	42	KLINKEBIEL J. (GER)	000 s0 / 102 s0 [02:37]
20	KLINKEBIEL Julia (GER)	100 s0 / 000 s1 [01:37]			
21	KILICKAYA Rumeysa Hatice (TUR)	020 s1 / 000 s0 [03:47]	43	STORM S. (GER)	000 s1 / 110 s1 [01:49]
22	KORDEL Mira (SWE)	000 s0 / 020 s0 [02:44]			
23	ROEMMER Amelie (GER)	020 s0 / 000 s1 [04:00]	44	ROEMMER A. (GER)	101 s0 / 000 s0 [01:42]
24	GOMBA-LOUIS-JEAN Kaylia (FRA)	000 s0 / 101 s0 [04:00]			

POOL D

25	BUETTNER Alesia (GER)	100 s0 / 000 s2 [02:40]	45	BUETTNER A. (GER)	020 s1 / 000 s0 [03:02]
26	MATOUSKOVA Valentyna (CZE)	102 s1 / 000 s2 [04:00]			
27	CIESZYNSKA Oliwia (POL)	100 s0 / 000 s0 [02:16]	46	POPOVIC K. (CRO)	000 s0 / 102 s0 [01:42]
28	PRED A Anamaria (ROU)	000 s0 / 100 s0 [00:29]			
29	MATUSZEKOVA Petra (SVK)	020 s1 / 000 s0 [02:50]	47	SAMOILIU D. (UKR)	100 s0 / 000 s1 [02:31]
30	BOZKURT Narin (GER)	000 s0 / 110 s0 [00:18]			
31	CIARDI Veronica (ITA)	100 s0 / 010 s0 [01:42]	48	SCERBOVA A. (CZE)	110 s0 / 000 s0 [02:22]
32	JEAN Chloe (FRA)	000 s0 / 100 s0 [02:16]			

REPECHAGE

61	ADAMACHI M. (ROU)	000 s1 / 110 s0 [01:56]	65	WENDT L. (GER)	000 s0 / 110 s0 [03:44]
62	KULIKAUSKAITE M. (LTU)	101 s1 / 000 s0 [02:38]	66	POKLOPOVA L. (CZE)	000 s2 / 020 s0 [04:00]
63	KILICKAYA R. (TUR)	101 s0 / 000 s1 [01:34]	67	KILICKAYA R. (TUR)	101 s0 / 000 s1 [01:34]
64	JEAN C. (FRA)	001 s2 / 000 s2 [04:00]	68	SCERBOVA A. (CZE)	001 s2 / 000 s2 [04:00]

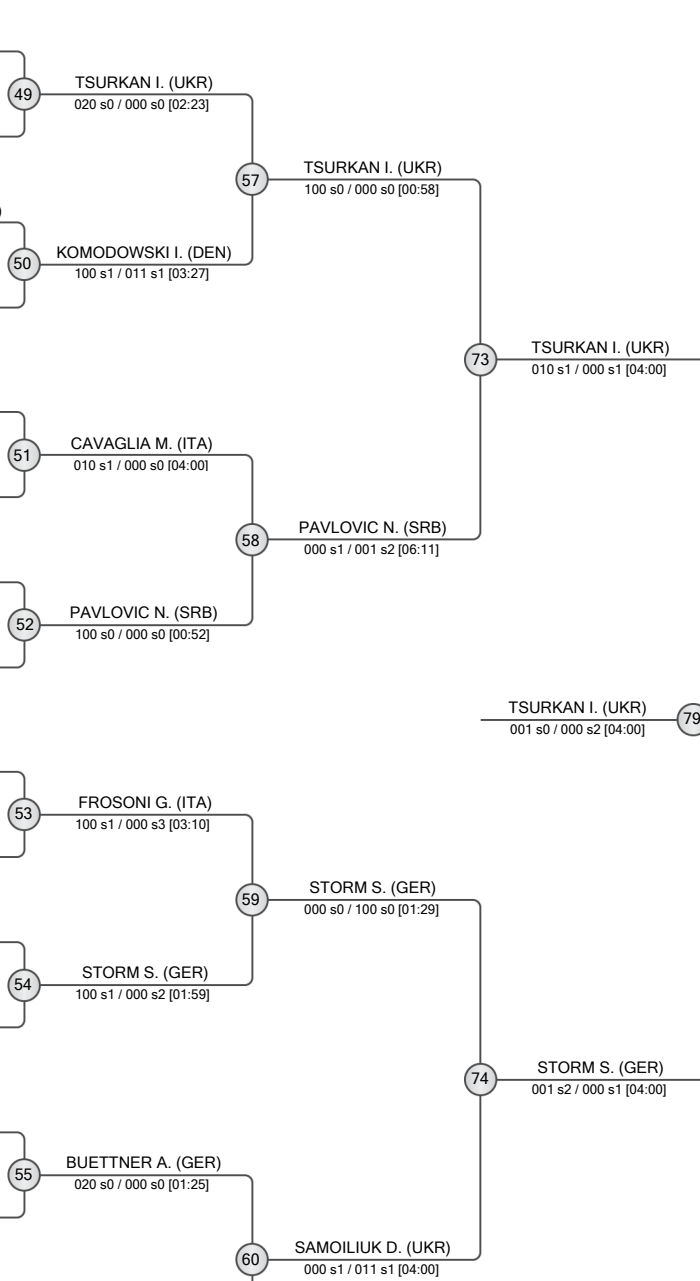

FINAL RESULTS		
1.	TSURKAN Ilariia	UKR
2.	STORM Sophia Grace	GER
3.	SAMOILIU D. (UKR)	UKR
4.	PAVLOVIC Nevena	SRB
5.	CAVAGLIA Marika	ITA
6.	JEAN Chloe	FRA
7.	KILICKAYA Rumeysa Hatice	TUR





Teplice Millennium Team Cadet European Cup 2025

Czechia, Teplice, 5-6 Apr 2025

-70 kg

Women (42)

POOL A

1	WELTER Leni (LUX)	2	WELTER L. (LUX)
2	RAGAUSKAITE Viktorija (LTU)	3	RAGAUSKAITE V. (LTU)
3	CAFARO Ginevra Margherita Pia (ITA)	4	CAFARO G. (ITA)
4	GOTTSCHALK Hedda (GER)	5	CAFARO G. (ITA)
5	SMUSZOVA Jirina (CZE)	6	SMUSZOVA J. (CZE)
6	BOB Isabel (ROU)	7	BOB I. (ROU)
7	KEDING Svenja (GER)	8	KEDING S. (GER)
8	BAUMANN Rosalie (AUT)	9	MAMMADLI M. (AZE)
9	MAMMADLI Masuma (AZE)	10	MAMMADLI M. (AZE)
10	ZUIDWIJK Noel (NED)	11	ZUIDWIJK N. (NED)
11		12	ZUIDWIJK N. (NED)

POOL B

9	BOELCSKEI Hanna (GER)	10	BOELCSKEI H. (GER)
10	SHIVITZ Mia (ITA)	11	SHIVITZ M. (ITA)
11	OMACKOVA Amalie (CZE)	12	OMACKOVA A. (CZE)
12	DZAGANIA Nini (GEO)	13	DZAGANIA N. (GEO)
13	PANOVICS Hanga (HUN)	14	PANOVICS H. (HUN)
14	DOVHUN Yana (UKR)	15	DOVHUN Y. (UKR)
15	GRASSI Giorgia (ITA)	16	GRASSI G. (ITA)
16	LATKOWSKI Antonia (GER)	17	LATKOWSKI A. (GER)
17	PAVIC Natasa (AUT)	18	PAVIC N. (AUT)
18	DOGSA Lara (SLO)	19	DOGSA L. (SLO)
19	BOGDAN Smaranda (ROU)	20	BOGDAN S. (ROU)
20		21	BOGDAN S. (ROU)

POOL C

17	MENANTEAU Jeanne (FRA)	18	MENANTEAU J. (FRA)
18	KARAFFOVA Vanessa (CZE)	19	KARAFFOVA V. (CZE)
19	MICHAIL Maria (CYP)	20	MICHAIL M. (CYP)
20	DALL ASTA Margherita (ITA)	21	DALL ASTA M. (ITA)
21	WAGNER Emelie (GER)	22	WAGNER E. (GER)
22	MRAVCAKOVA Karolina (SVK)	23	MRAVCAKOVA K. (SVK)
23	FEHER Zara (ROU)	24	FEHER Z. (ROU)
24	ZOLEZZI Noemi (ITA)	25	ZOLEZZI N. (ITA)
25	JURCIKOVA Viktorie (CZE)	26	JURCIKOVA V. (CZE)
26	MALCZAK Lara Katharina (GER)	27	MALCZAK L. (GER)
27	RABL Mavie (AUT)	28	RABL M. (AUT)
28		29	RABL M. (AUT)

POOL D

25	KURDGELIA Elene (GEO)	26	KURDGELIA E. (GEO)
26	JAMER Lara (SLO)	27	JAMER L. (SLO)
27	AHMADOVA Rena (AZE)	28	AHMADOVA R. (AZE)
28	FARAUANU Iasmina (ROU)	29	FARAUANU I. (ROU)
29	FILZWIESER Emma (AUT)	30	FILZWIESER E. (AUT)
30	WUEGERER Selina (AUT)	31	WUEGERER S. (AUT)
31	ENS Daaje (GER)	32	ENS D. (GER)
32	ZENUNI Sara (ITA)	33	ZENUNI S. (ITA)
33	KUCEROVA Anna (CZE)	34	KUCEROVA A. (CZE)
34	MOREIRA Joana (POR)	35	MOREIRA J. (POR)
35		36	MOREIRA J. (POR)

REPECHAGE

61	MAMMADLI M. (AZE)	62	MAMMADLI M. (AZE)
62	LATKOWSKI A. (GER)	63	LATKOWSKI A. (GER)
63	MENANTEAU J. (FRA)	64	MENANTEAU J. (FRA)
64	JAMER L. (SLO)	65	JAMER L. (SLO)
65		66	JAMER L. (SLO)
66		67	JAMER L. (SLO)
67		68	JAMER L. (SLO)
68		69	JAMER L. (SLO)
69		70	JAMER L. (SLO)
70		71	JAMER L. (SLO)
71		72	JAMER L. (SLO)
72		73	JAMER L. (SLO)
73		74	JAMER L. (SLO)
74		75	JAMER L. (SLO)
75		76	JAMER L. (SLO)
76		77	JAMER L. (SLO)
77		78	JAMER L. (SLO)
78		79	JAMER L. (SLO)

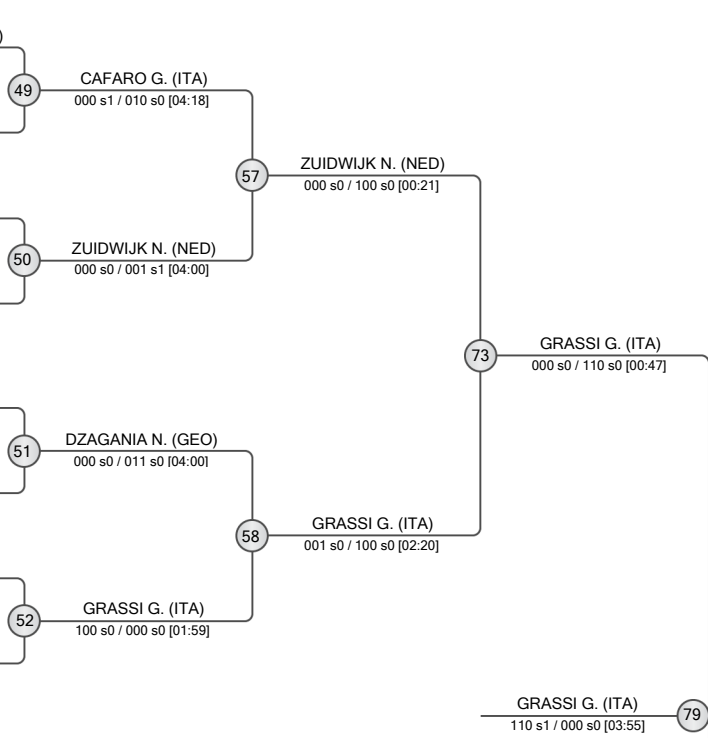

FINAL RESULTS		
1.	GRASSI Giorgia	ITA
2.	KURDGELIA Elene	GEO
3.	DZAGANIA Nini	GEO
4.	WUEGERER Selina	AUT
5.	KARAFFOVA Vanessa	CZE
6.	ZUIDWIJK Noel	NED
7.	CAFARO Ginevra Margherita Pia	ITA
8.	MENANTEAU Jeanne	FRA





Teplice Millennium Team Cadet European Cup 2025

Czechia, Teplice, 5-6 Apr 2025

+ 70 kg

Women (26)

POOL A

ZAREBA Nikola	POL
ALIYEVA Zemfira	AZE
PALERMO Elisa	ITA
DILGER Elina	GER
HVALEC Klara	SLO
COULIBALY TOURE Ballalo	ESP
KHIMCHYK Myroslava	UKR

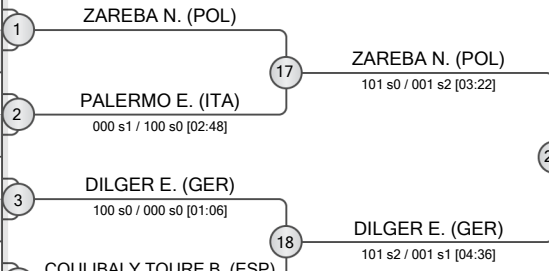

POOL B

HOELLWART Michaela	AUT
BAHMET Kira	UKR
FERREIRA Margarida	POR
SACKO Astan	FRA
VAN DRIEL Nova	NED
PFISTER Arlette	GER

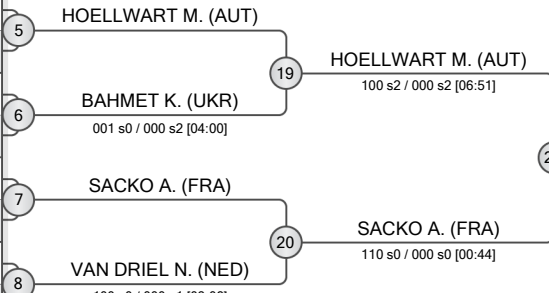

POOL C

SCHIAVON Carlotta	ITA
JURAK Jazmin	HUN
BARTHEL Tina	GER
SERIN Nisanur	TUR
SKRABAN Lana	SLO
SAMOLIUK Anna	UKR
PEREIRA Kelly	POR

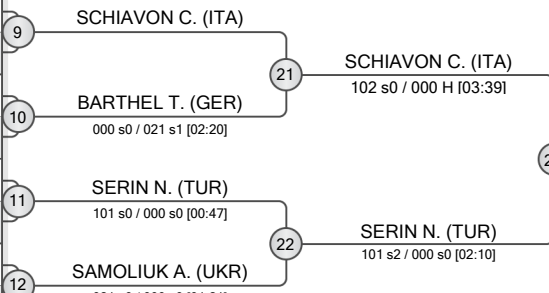

POOL D

AJDUKOVIC Antea	CRO
MAGASSA FOFANA Sogona	ESP
PRUESSE Elina	GER
EININGE Saule	LTU
DJEDIAT Imen	SUI
PODZEMNA Zuzana	CZE

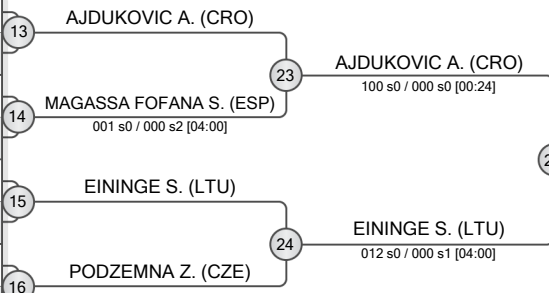

REPECHAGE

HVALEC K. (SLO)	COULIBALY TOURE B. (ESP)	29
COULIBALY TOURE B. (ESP)	ZAREBA N. (POL)	33
VAN DRIEL N. (NED)	HOELLWART M. (AUT)	34
BARTHEL T. (GER)	SERIN N. (TUR)	35
MAGASSA FOFANA S. (ESP)	EININGE S. (LTU)	36

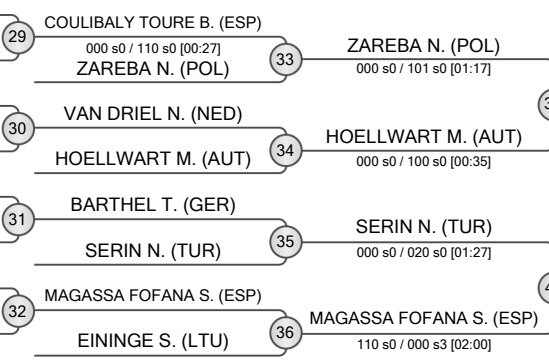

FINAL RESULTS	
1. AJDUKOVIC Antea	CRO
2. DILGER Elina	GER
3. ZAREBA Nikola	POL
3. SACKO Astan	FRA
5. SCHIAVON Carlotta	ITA
5. SERIN Nisanur	TUR
7. HOELLWART Michaela	AUT
7. MAGASSA FOFANA Sogona	ESP

