



Poznan Junior European Cup 2025

Poland, Poznan, 5-6 Apr 2025

-60 kg
Men (31)

POOL A

	TOMANEK Jozef	SVK
	MAMISHOV Nihad	AZE
	BIEDRZYCKI Hubert	POL
	MEHDITACHE Ido	ISR
	SMEJKAL Stepan	CZE
	WALINGA Ruben	NED
	KAMINSKY A. Andriy	UKR

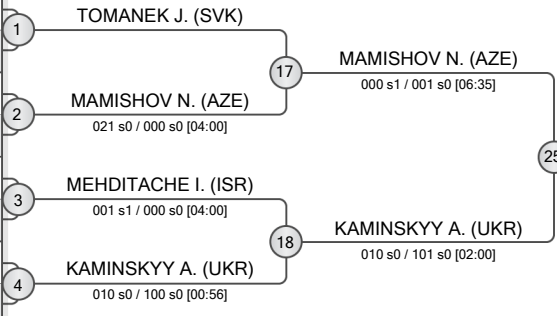

POOL B

	AYRE Charlie	GBR
	KORNATKA Kacper	POL
	TSJKADOE A Luca	NED
	SHCHEKOTIN Filipp	EST
	ASHPIZ Izhak	ISR
	OROZMAMATOV Adis	KGZ
	KOLONDR A Jan	POL
	SCHLEER Joris	GER

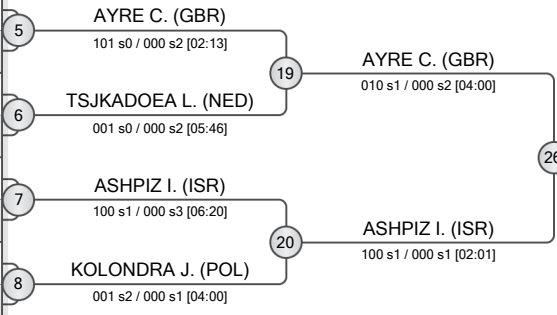

POOL C

	LEE Casey	AUS
	GARAYEV Farid	AZE
	CABECANA Luke	GER
	PIECHOTA Stanislaw	POL
	SHENKMAN Tal	ISR
	GUIKEMA Michel	NED
	SANNA Riccardo	ITA
	MUNIZ ACOSTA Jakub	POL

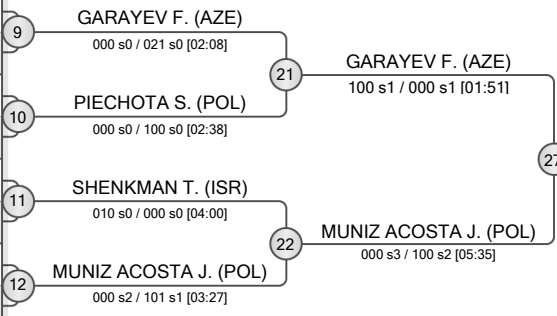

POOL D

	NAVON Maayan	ISR
	SWITALA Pawel	POL
	LOEFFLER Kilian	GER
	BRONSV OORD Jarno	NED
	TAMARY Ben	ISR
	MALIKOV Semen	UKR
	CHARALAMPOUS Stratos	CYP
	PILKA Oleh	POL

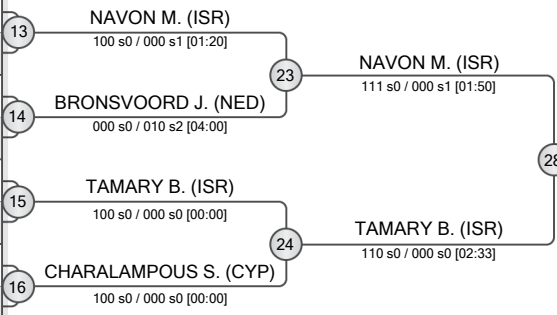

REPECHAGE

WALINGA R. (NED)	29	WALINGA R. (NED)	33	MAMISHOV N. (AZE)
MEHDITACHE I. (ISR)		MAMISHOV N. (AZE)		
OROZMAMATOV A. (KGZ)		KOLONDR A J. (POL)		
KOLONDR A J. (POL)	30	AYRE C. (GBR)	34	AYRE C. (GBR)
LEE C. (AUS)		PIECHOTA S. (POL)		
PIECHOTA S. (POL)	31	MUNIZ ACOSTA J. (POL)	35	MUNIZ ACOSTA J. (POL)
SWITALA P. (POL)		SWITALA P. (POL)		
BRONSV OORD J. (NED)	32	TAMARY B. (ISR)	36	TAMARY B. (ISR)

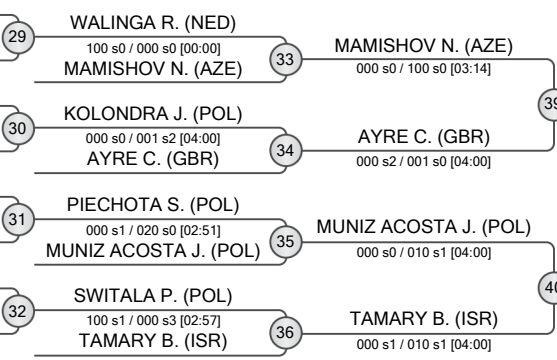

FINAL RESULTS	
1. GARAYEV Farid	AZE
2. ASHPIZ Izhak	ISR
3. MAMISHOV Nihad	AZE
3. MUNIZ ACOSTA Jakub	POL
5. NAVON Maayan	ISR
5. KAMINSKY A. Andriy	UKR
7. AYRE Charlie	GBR
7. TAMARY Ben	ISR





Poznan Junior European Cup 2025

Poland, Poznan, 5-6 Apr 2025

-66 kg

Men (58)

POOL A

1	KLODA Gal (ISR)	1	KLODA G. (ISR)
2	GABRIEL Igor (POL)	33	GABRIEL I. (POL)
3	RICHARDSON Luca (NED)	34	RICHARDSON L. (NED)
4	KELLER Adrian (GER)	35	JAKIMOV E. (EST)
5	JAKIMOV Edward (EST)	36	HERMSEN D. (NED)
6	FERENC Wojciech (POL)		
7	BABICH Vladyslav (UKR)		
8	ZINK Stepan (CZE)		
	RESIAK Marcel (POL)		
	COHEN Shalev (ISR)		
	HERMSEN Dani (NED)		
	DRESE Leonas (GER)		

POOL B

9	KRAVCHENKO Danylo (UKR)	9	KRAVCHENKO D. (UKR)
10	ZEEVI Itamar (ISR)	37	ZEEVI I. (ISR)
11	LAURITZEN Magni (DEN)	38	LAURITZEN M. (DEN)
12	SANDLERMAN Artur (POL)	39	VELSTRA S. (NED)
13	BOYUKKISHIYEV Emin (AZE)	40	MAKALATIYA D. (GER)
14	WEGELE Maxim (GER)		
15	KLOBUCNIK Matej (SVK)		
16	VELSTRA Sij (NED)		
	ZEMLA Patryk (POL)		
	KASPARAVICIUS Nidijus (LTU)		
	SLEDZ Tomasz (POL)		
	TSAPARAS Konstantinos (GRE)		
	MAKALATIYA Demetres (GER)		

POOL C

17	POLIKEVICIUS Simas (LTU)	17	POLIKEVICIUS S. (LTU)
18	SWIDERSKI Oskar (POL)	41	SWIDERSKI O. (POL)
19	SUSEBEEK Bo (NED)	42	IVTCHENKO M. (GER)
20	VELYKYI Artur (POL)	43	SAVCHENKO M. (POL)
21	LAVI Ori (ISR)	44	KUPPER D. (GER)
22	NOERSKOV Oliver (DEN)		
23	MIDDLETON Vas (AUS)		
24	KOPECKY Matej (CZE)		
25	SUR Mihhail (EST)		
26	SAVCHENKO Maksym (POL)		
27	SAPUNOV Andrii (POL)		
28	MARTYNCHUK Oleksandr (UKR)		
29	KUPPER David (GER)		
30	FALLAH DAR Rastin (GBR)		

POOL D

25	MUSAYEV Mahammad (AZE)	25	MUSAYEV M. (AZE)
26	ROSU Yarin (ISR)	45	ODKLADAL J. (SVK)
27	ODKLADAL Juraj (SVK)	46	VREELING T. (NED)
28	DOTSENKO Denys (UKR)	47	FAAS S. (NED)
29	VREELING Tristan (NED)	48	GAFFARLI A. (GER)
30	TYMINSKI Maksymilian (POL)		
31	BALIEV Ramzan (GER)		
32	SHERER Ziv (ISR)		
	FAAS Siebe (NED)		
	GRUBELSKI Jakub (POL)		
	GHISLER Henry (SWE)		
	GAFFARLI Al-Huseyn (GER)		
	DERKACZ Marcel (POL)		
	GALIA Jan (CZE)		

REPECHAGE

61	POBLOCKI S. (SWE)	61	TSUKANOV N. (POL)
62	TSUKANOV N. (POL)	62	ZEEVI I. (ISR)
63	ZEEVI I. (ISR)	63	SWIDERSKI O. (POL)
64	SWIDERSKI O. (POL)	64	ODKLADAL J. (SVK)
65	KLODA G. (ISR)	65	VREELING T. (NED)
66	HERMSEN D. (NED)	66	
67	Lauritzen M. (DEN)	67	
68	Lauritzen M. (DEN)	68	
69	Klobucnik M. (SVK)	69	
70	IVTCHENKO M. (GER)	70	
71	SAVCHENKO M. (POL)	71	
72	ODKLADAL J. (SVK)	72	
73	VREELING T. (NED)	73	
74	SHERER Z. (ISR)	74	
75	SHERER Z. (ISR)	75	
76	SHERER Z. (ISR)	76	
77	SHERER Z. (ISR)	77	
78	SHERER Z. (ISR)	78	

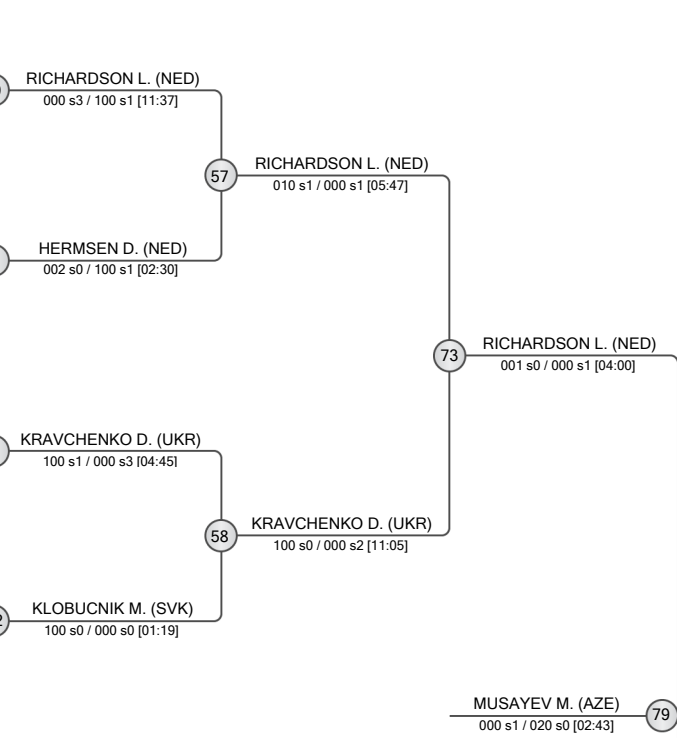

FINAL RESULTS		
1.	MUSAYEV Mahammad	AZE
2.	RICHARDSON Luca	NED
3.	POLIKEVICIUS Simas	LTU
3.	KRAVCHENKO Danylo	UKR
5.	LAURITZEN Magni	DEN
5.	IVTCHENKO Marc	GER
7.	KLODA Gal	ISR
7.	SHERER Ziv	ISR





Poznan Junior European Cup 2025

Poland, Poznan, 5-6 Apr 2025

-73 kg

Men (57)

POOL A

AKOPJAN Arthur	GER	1	AKOPJAN A. (GER)
HABZO Ariel	ISR	2	HABZO A. (ISR)
WIWATOWSKI Bartosz	POL	3	AKOTO R. (GER)
AKOTO Raphael	GER	3	AKOTO R. (GER)
FUCHS Pawel	POL	4	BRISUDA S. (SVK)
BRISUDA Samuel	SVK	4	BRISUDA S. (SVK)
RIDOUT Oliver	GBR	5	VARDANIAN N. (SWE)
KAZIMIERCZAK Adam	POL	5	VARDANIAN N. (SWE)
VARDANIAN Narek	SW	6	DAVIES P. (GBR)
DAVIES Peter	GBR	6	DAVIES P. (GBR)
BARSKE Rufus	GER	7	TAAVITSAINEN J. (FIN)
BOGDANSKI Teodor	POL	7	TAAVITSAINEN J. (FIN)
TAAVITSAINEN Jesper	FIN	8	STEFANSKI A. (POL)
POT Daan	NED	8	STEFANSKI A. (POL)
STEFANSKI Adrian	POL		

POOL B

VAN DER VEEN Quinten	NED	9	VAN DER VEEN Q. (NED)
SOBCHENKO Mykhailo	POL	10	MOLOSHYK D. (UKR)
MOLOSHYK Danylo	UKR	10	MOLOSHYK D. (UKR)
CELADINS Nikita	LAT	11	NOACK M. (GER)
JAREMKO Kamil	POL	11	NOACK M. (GER)
RESUTIK Adam	CZE	12	BULOCINIC T. (ISR)
NOACK Melvin	GER	12	BULOCINIC T. (ISR)
BULOCINIC Tom	ISR	13	MUSZYNSKI J. (POL)
MUSZYNSKI Jakub	POL	14	MUSZYNSKI J. (POL)
BIRLUND Aksel	DEN	15	KUSTRZYCKI K. (POL)
KUSTRZYCKI Kamil	POL	15	KUSTRZYCKI K. (POL)
MACLEOD Jack	GBR	16	JAFAROV M. (AZE)
JAFAROV Mehdi	AZE	16	JAFAROV M. (AZE)
HUEPENBECKER Louis	GER		

POOL C

GOGINASHVILI Irakli	GBR	17	GOGINASHVILI I. (GBR)
KOBYLINSKI Jakub	POL	18	JOVSA D. (LTU)
JOVSA Deividas	LTU	18	JOVSA D. (LTU)
QADDOURAH Karim	POL	19	GUENTHER N. (GER)
DEKAN Roman	SVK	19	GUENTHER N. (GER)
PLUTA Pawel	POL	20	MORITZ O. (ISR)
GUENTHER Nouri	GER	20	MORITZ O. (ISR)
MORITZ Ohad	ISR	21	ZITA O. (CZE)
BETKOWSKI Milosz	POL	22	ZITA O. (CZE)
ZITA Ondrej	CZE	22	ZITA O. (CZE)
GOLEDZINOWSKI Jakub	POL	23	LA FONTAINE B. (NED)
LA FONTAINE Basile	NED	23	LA FONTAINE B. (NED)
MARLOV Alexander	SWE	24	MARLOV A. (SWE)
KITAGAWA Alexander	GER	24	MARLOV A. (SWE)

POOL D

LEVY Benjamin	GBR	25	LEVY B. (GBR)
BLOMHERT Daniel	NED	26	BLOMHERT D. (NED)
MAMINSKI Konrad	POL	26	BLOMHERT D. (NED)
YOKOYAMA Yuichi	GER	27	YOKOYAMA Y. (GER)
BENKOV Oleksandr	POL	27	YOKOYAMA Y. (GER)
SVIDRAK Volodymyr	UKR	28	SVIDRAK V. (UKR)
SHERIMBEKOV Amir	KGZ	28	SVIDRAK V. (UKR)
YUSUBOV Abil	AZE	29	YUSUBOV A. (AZE)
DABROWSKI Norbert	POL	30	DABROWSKI N. (POL)
BURMEISTER Luis	GER	30	DABROWSKI N. (POL)
HEFFERNAN Eden	GBR	31	HEFFERNAN E. (GBR)
KURAUJI Iakovos	CYP	31	HEFFERNAN E. (GBR)
BLYZNIUK Tymur	POL	32	BLYZNIUK T. (POL)
VARMUZKA Matej	CZE	32	BLYZNIUK T. (POL)

REPECHAGE

KAZIMIERCZAK A. (POL)	61	DAVIES P. (GBR)	65	TAAVITSAINEN J. (FIN)	69	AKOTO R. (GER)
DAVIES P. (GBR)		TAAVITSAINEN J. (FIN)		AKOTO R. (GER)		
SOBCHENKO M. (POL)	62	VAN DER VEEN Q. (NED)	66	VAN DER VEEN Q. (NED)	70	BULOCINIC T. (ISR)
VAN DER VEEN Q. (NED)		NOACK M. (GER)		BULOCINIC T. (ISR)		
JOVSA D. (LTU)	63	JOVSA D. (LTU)	67	GUENTHER N. (GER)	71	MARLOV A. (SWE)
GUENTHER N. (GER)		GUENTHER N. (GER)		MARLOV A. (SWE)		
DABROWSKI N. (POL)	64	DABROWSKI N. (POL)	68	DABROWSKI N. (POL)	72	LEVY B. (GBR)
HEFFERNAN E. (GBR)		HEFFERNAN E. (GBR)		LEVY B. (GBR)		

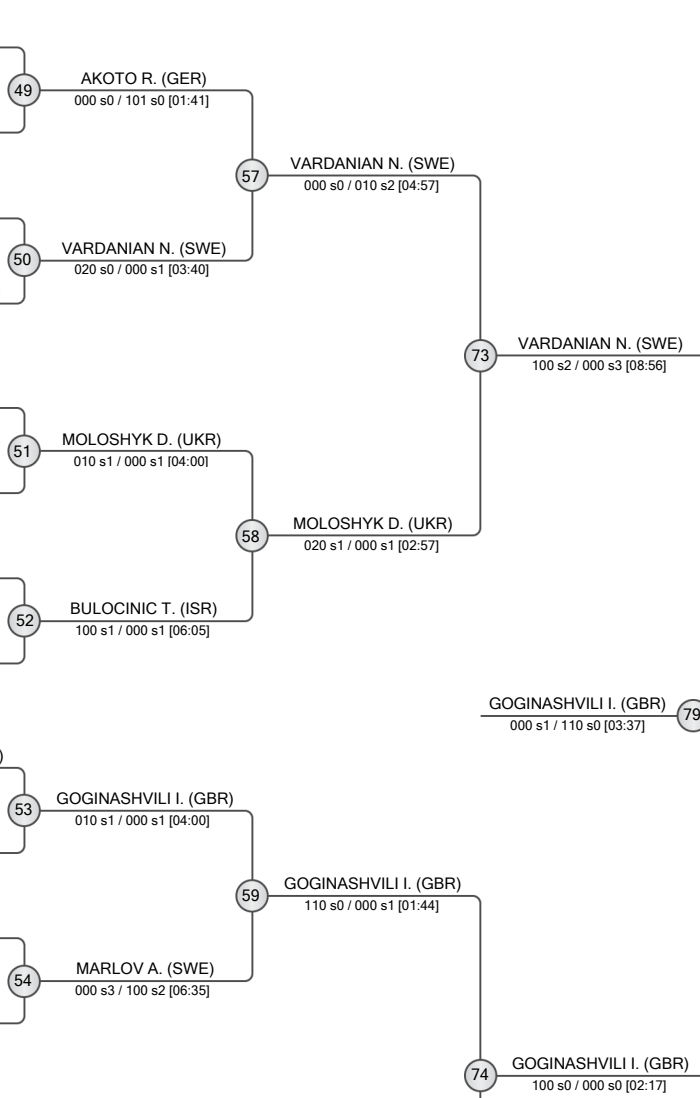

FINAL RESULTS		
1.	GOGINASHVILI Irakli	GBR
2.	VARDANIAN Narek	SWE
3.	YUSUBOV Abil	AZE
5.	AKOTO Raphael	GER
5.	LEVY Benjamin	GBR
7.	BULOCINIC Tom	ISR
7.	MARLOV Alexander	SWE





Poznan Junior European Cup 2025

Poland, Poznan, 5-6 Apr 2025

-81 kg

Men (52)

POOL A

1	SHUKUROV Suleyman (AZE)	SHUKUROV S. (AZE)
2	PLOSTNIEKS Ronalds (LAT)	PLOSTNIEKS R. (LAT)
3	SAHIR Stanislav (UKR)	SAHIR S. (UKR)
4	LALAIKE Yoshiya (GER)	LALAIKE Y. (GER)
5	DIKAJEV Saad (EST)	DIKAJEV S. (EST)
6	PERTELSON Kristofer (FIN)	PERTELSON K. (FIN)
7	MASHKO Dzmityry (POL)	GROSMAN Y. (ISR)
8	BLIN Matej (CZE)	GROSMAN Y. (ISR)
	GROSMAN Yair (ISR)	DAVIES L. (GBR)
	DAVIES Luke (GBR)	DAVIES L. (GBR)

POOL B

9	NIELZIEV Taras (UKR)	NIELZIEV T. (UKR)
10	MATTSSON Ville (SWE)	HEINEMANN E. (GER)
11	HEINEMANN Erik (GER)	MAROUSEK A. (CZE)
12	MAROUSEK Alex (CZE)	LEWANDOWSKI Franciszek (POL)
13	LEWANDOWSKI Franciszek (POL)	AVDEJEVS Aleksandrs (LAT)
14	AVDEJEVS Aleksandrs (LAT)	KAPSOUROS Marios (GRE)
15	KAPSOUROS Marios (GRE)	HULSHOF Quinn (NED)
16	HULSHOF Quinn (NED)	ZAWADKA Jakub (POL)
	ZAWADKA Jakub (POL)	KOCZINSKI Arel (ISR)
	KOCZINSKI Arel (ISR)	PUSHKAROV Denys (SVK)
	PUSHKAROV Denys (SVK)	KHAMMO Viacheslav (UKR)
	KHAMMO Viacheslav (UKR)	BRZUSZCZYNSKI Szymon (POL)
	BRZUSZCZYNSKI Szymon (POL)	

POOL C

17	TSURKAN Igor (UKR)	TSURKAN I. (UKR)
18	DISTEL Konstantin (GER)	DISTEL K. (GER)
19	JACENKO Arturs (LAT)	JACENKO A. (LAT)
20	ADAMEC Tomas Ignac (CZE)	ADAMEC T. (CZE)
21	KRAWCZYK Bartosz (POL)	KRAWCZYK B. (POL)
22	VAN RIEL Stan (NED)	VAN RIEL S. (NED)
23	NEUMANN Eryk (GBR)	NEUMANN E. (GBR)
24	PARKHOMENKO Maksym (UKR)	FRIDMAN ZILBERSTEIN Reem (ISR)
25	FRIDMAN ZILBERSTEIN Reem (ISR)	FRIDMAN ZILBERSTEIN R. (ISR)
26	RACKA Norbertas (LTU)	ANARBEKOV A. (KGZ)
27	ANARBEKOV Arsen (KGZ)	ANARBEKOV A. (KGZ)
28	IBADLI Jasur (AZE)	IBADLI J. (AZE)
29	IBADLI Jasur (AZE)	IBADLI J. (AZE)
30	SWIDWA Robert (POL)	SWIDWA R. (POL)

POOL D

31	TARKOWSKI Fabrycjusz (POL)	TARKOWSKI F. (POL)
32	KRAAK Pepijn (NED)	GORUN V. (UKR)
33	GORUN Volodymyr (UKR)	GORUN V. (UKR)
34	YOSUL Can Ilias (GER)	YOSUL C. (GER)
35	KUCERA Kristian (CZE)	KUCERA K. (CZE)
36	BALAMPANIDIS Iraklis (GRE)	BALAMPANIDIS I. (GRE)
37	BALAMPANIDIS Iraklis (GRE)	BALAMPANIDIS I. (GRE)
38	AGRONOV Yaniv (ISR)	AGRONOV Y. (ISR)
39	AGRONOV Yaniv (ISR)	AGRONOV Y. (ISR)
40	MOYLETT Antony (GBR)	MOYLETT A. (GBR)
41	MOYLETT Antony (GBR)	MOYLETT A. (GBR)
42	LUDZIA Franciszek (POL)	LUDZIA F. (POL)
43	SZULIK Szymon (POL)	SZULIK S. (POL)
44	SZULIK Szymon (POL)	SZULIK S. (POL)
45	BUJUKLIEV Alex (SWE)	BUJUKLIEV A. (SWE)
46	PYSHNIAK Bohdan (UKR)	PYSHNIAK B. (UKR)
47	PYSHNIAK Bohdan (UKR)	PYSHNIAK B. (UKR)
48	MOZGO Dautartas (LTU)	MOZGO D. (LTU)

REPECHAGE

61	PLOSTNIEKS R. (LAT)	PLOSTNIEKS R. (LAT)
62	MAROUSEK A. (CZE)	MAROUSEK A. (CZE)
63	PARKHOMENKO M. (UKR)	NEUMANN E. (GBR)
64	NEUMANN E. (GBR)	GORUN V. (UKR)
65	SAHIR S. (UKR)	SAHIR S. (UKR)
66	MAROUSEK A. (CZE)	NIELZIEV T. (UKR)
67	IBADLI J. (AZE)	IBADLI J. (AZE)
68	BALAMPANIDIS I. (GRE)	BALAMPANIDIS I. (GRE)
69	PLOSTNIEKS R. (LAT)	PLOSTNIEKS R. (LAT)
70	KOCZINSKI A. (ISR)	KOCZINSKI A. (ISR)
71	DISTEL K. (GER)	DISTEL K. (GER)
72	BALAMPANIDIS I. (GRE)	BALAMPANIDIS I. (GRE)
73	SHUKUROV S. (AZE)	SHUKUROV S. (AZE)
74	TARKOWSKI F. (POL)	TARKOWSKI F. (POL)
75	KOCZINSKI A. (ISR)	KOCZINSKI A. (ISR)
76	IBADLI J. (AZE)	IBADLI J. (AZE)
77	FRIDMAN ZILBERSTEIN R. (ISR)	FRIDMAN ZILBERSTEIN R. (ISR)
78	AVDEJEVS A. (LAT)	AVDEJEVS A. (LAT)
79	TARKOWSKI F. (POL)	TARKOWSKI F. (POL)

FINAL RESULTS

- TARKOWSKI Fabrycjusz (POL)
- SHUKUROV Suleyman (AZE)
- FRIDMAN ZILBERSTEIN Reem (ISR)
- AVDEJEVS Aleksandrs (LAT)
- KOCZINSKI Arel (ISR)
- IBADLI Jasur (AZE)
- PLOSTNIEKS Ronalds (LAT)
- BALAMPANIDIS Iraklis (GRE)





Poznan Junior European Cup 2025

Poland, Poznan, 5-6 Apr 2025

-90 kg

Men (36)

POOL A

1	SHAMIL Tuncay (AZE)	1	SHAMIL T. (AZE)
2	RONIS Alexander (ISR)	33	SHAMIL T. (AZE)
3	OLEKSY Mateusz (POL)	34	SHAMIL T. (AZE)
4	KHOROSHAILOV Mykhailo (UKR)	34	SHAMIL T. (AZE)
5	SPYRYDONOV Daniil (GER)	35	SHAMIL T. (AZE)
6	SIERAKOWSKI Mateusz (POL)	35	SHAMIL T. (AZE)
7	FOUKAL Ondrej (CZE)	36	SHAMIL T. (AZE)
8	PARSHYN Viacheslav (UKR)	36	SHAMIL T. (AZE)
	KURACH Dominik (POL)		

POOL B

9	LAUFMANIS Ernests (LAT)	37	LAUFMANIS E. (LAT)
10	TOMASZKIEWICZ Justus (POL)	37	LAUFMANIS E. (LAT)
11	LASZCZOK Nikodem (POL)	38	NEDERBRAGT B. (NED)
12	NEDERBRAGT Bram (NED)	38	NEDERBRAGT B. (NED)
13	HICKEY Cameron (GBR)	39	HICKEY C. (GBR)
14	RUDI Lennox (GER)	39	HICKEY C. (GBR)
15	SOKYRKO Serhii (UKR)	40	SOKYRKO S. (UKR)
16	JAKS Adam (CZE)	40	SOKYRKO S. (UKR)
	BOGDANSKI Wojciech (POL)		

POOL C

17	PACARIZ Armin (GER)	41	PACARIZ A. (GER)
18	SOKOLOWSKI Konrad (POL)	41	PACARIZ A. (GER)
19	MANFELDS Tomass (LAT)	42	GAZIMAMMADOV A. (AZE)
20	KRAUSS Jan (POL)	42	GAZIMAMMADOV A. (AZE)
21	GAZIMAMMADOV Ali (AZE)	43	BAALMANS N. (NED)
22	BAALMANS Nils (NED)	43	BAALMANS N. (NED)
23	HARMASH Ivan (UKR)	44	BRESLER Y. (ISR)
24	HARMASH I. (UKR)	44	BRESLER Y. (ISR)
	KOZLOWSKI Maciej (POL)		
	BRESLER Yonatan (ISR)		

POOL D

25	MARCZAK Derek (POL)	45	MARCZAK D. (POL)
26	KIRK Joseph (GBR)	45	MARCZAK D. (POL)
27	WILLSCH Justin (GER)	46	POTUCEK T. (CZE)
28	POTUCEK Tomas (CZE)	46	POTUCEK T. (CZE)
29	GRZESKOWIAK Adam (POL)	47	BRAZANI G. (ISR)
30	GRZESKOWIAK A. (POL)	47	BRAZANI G. (ISR)
31	BRAZANI Gal (ISR)	48	TOKHTAMYSH O. (UKR)
32	YAKHNIN Georgy (GER)	48	TOKHTAMYSH O. (UKR)
	TOKHTAMYSH Aleksandr (UKR)		
	PASZEK Damian (POL)		

REPECHAGE

61	RONIS A. (ISR)	65	RONIS A. (ISR)
62	JAKS A. (CZE)	66	HICKEY C. (GBR)
63	BOGDANSKI W. (POL)	67	BAALMANS N. (NED)
64	KIRK J. (GBR)	68	POTUCEK T. (CZE)

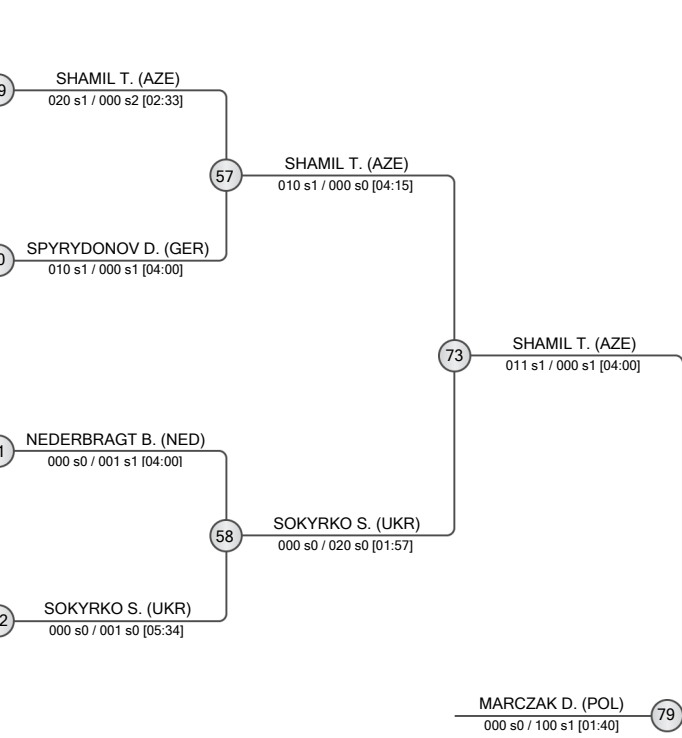

FINAL RESULTS	
1.	MARCZAK Derek (POL)
2.	SHAMIL Tuncay (AZE)
3.	NEDERBRAGT Bram (NED)
3.	SOKYRKO Serhii (UKR)
5.	BRESLER Yonatan (ISR)
5.	BRAZANI Gal (ISR)
7.	SPYRYDONOV Daniil (GER)
7.	PACARIZ Armin (GER)





Poznan Junior European Cup 2025

Poland, Poznan, 5-6 Apr 2025

+100 kg

Men (15)

POOL A

	SUHA Mortaza	GER
	DOBRIAN Marcel	POL
	FESENKO Oleh	UKR

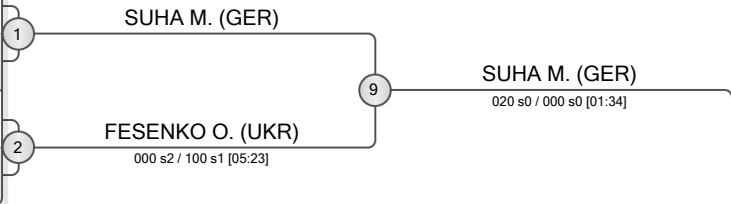

POOL B

	YAROSHENKO Fedir	UKR
	WILHELM Christian	GER
	MASAK Marek-Adrian	EST
	ALIYEV Eldar	AZE

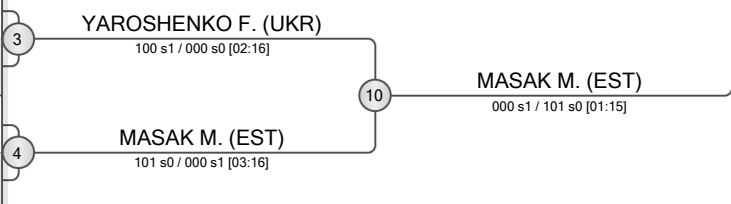

POOL C

	OMELCHENKO Yaroslav	UKR
	DAMM Felix	GER
	SEDLAK Martin	CZE
	KHACHATRYAN Anton	POL

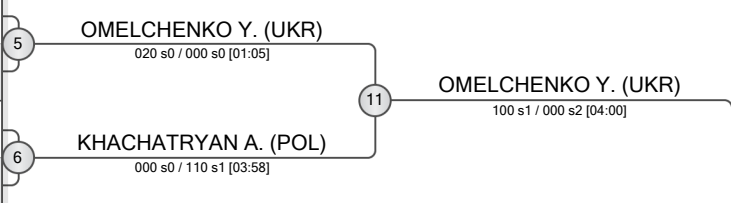

POOL D

	AHMADOV Ramazan	AZE
	BALLERING Martinus	NED
	CHAMERSKI Daniel	POL
	KULCHYTSKYI Denys	UKR

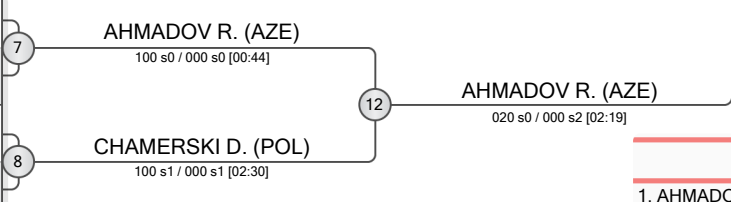

REPECHAGE

13 FESENKO O. (UKR)
14 ALIYEV E. (AZE)
15 KHACHATRYAN A. (POL)
16 BALLERING M. (NED)

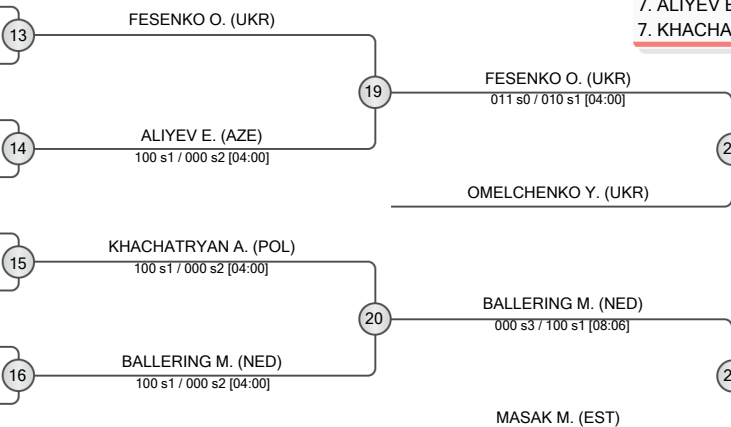

FINAL RESULTS		
1.	AHMADOV Ramazan	AZE
2.	SUHA Mortaza	GER
3.	OMELCHENKO Yaroslav	UKR
3.	MASAK Marek-Adrian	EST
5.	FESENKO Oleh	UKR
5.	BALLERING Martinus	NED
7.	ALIYEV Eldar	AZE
7.	KHACHATRYAN Anton	POL





Poznan Junior European Cup 2025

Poland, Poznan, 5-6 Apr 2025

-48 kg

Women (15)

POOL A

	HABIB Helen	GER
	GHAFFAR Asal	GER
	POTOK Nina	POL

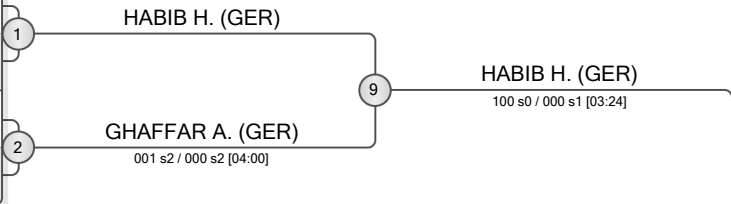

POOL B

	HOEKSTRA Robin	NED
	CZERWINSKA-KOWAR Roksana	POL
	TWAROWSKA Barbara	POL
	WARNERS Megan	NED

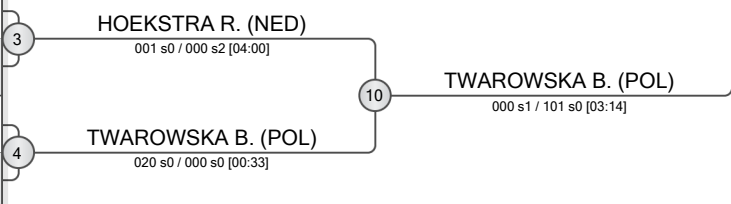

POOL C

	TOMANKOVA Patricia	SVK
	ZGLICZYNSKA Alicja	POL
	STOFBERG Lara	NED
	KABELKOVA Karolina	CZE

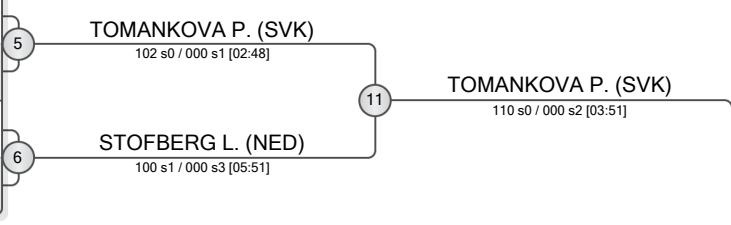

POOL D

	RIKMANSPOEL Maud	NED
	MUTAEVA Sofija	POL
	KOZUCH Oliwia	POL
	BULGA Nicola	GBR

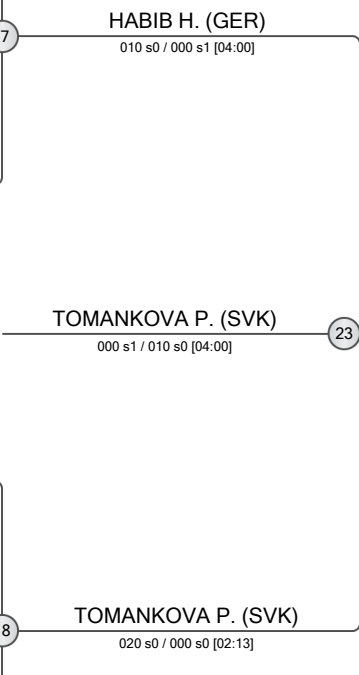
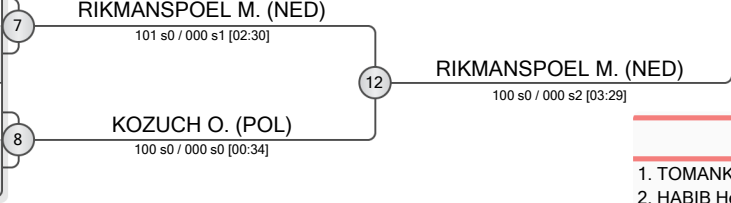

FINAL RESULTS		
1.	TOMANKOVA Patricia	SVK
2.	HABIB Helen	GER
3.	RIKMANSPOEL Maud	NED
3.	TWAROWSKA Barbara	POL
5.	HOEKSTRA Robin	NED
5.	STOFBERG Lara	NED
7.	GHAFFAR Asal	GER
7.	KOZUCH Oliwia	POL

REPECHAGE

GHAFFAR A. (GER)	13	GHAFFAR A. (GER)
WARNERS M. (NED)		
HOEKSTRA R. (NED)	14	HOEKSTRA R. (NED) [03:08]
ZGLICZYNSKA A. (POL)		
STOFBERG L. (NED)	15	STOFBERG L. (NED) [03:08]
MUTAEVA S. (POL)		
KOZUCH O. (POL)	16	KOZUCH O. (POL) [03:08]

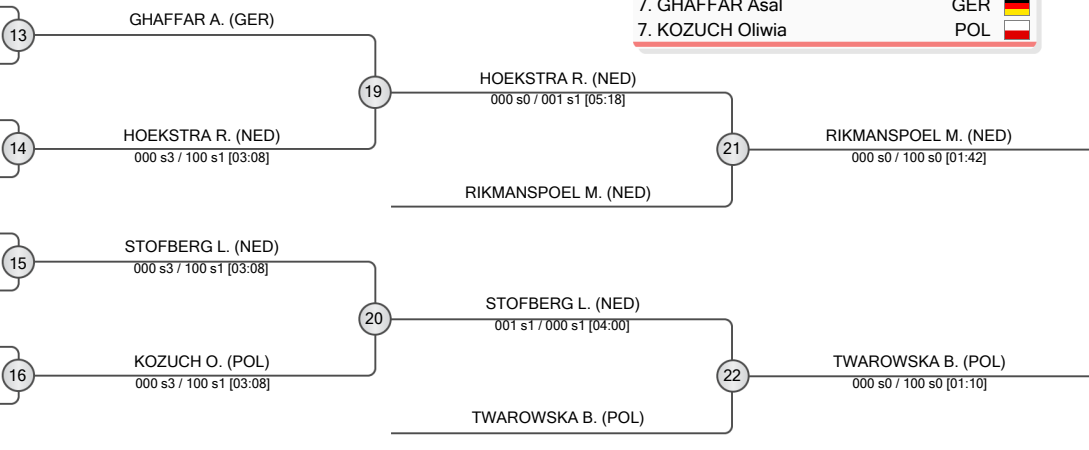



Poznan Junior European Cup 2025

Poland, Poznan, 5-6 Apr 2025

-52 kg

Women (23)

POOL A

	MECKLENBURG Tabea Nika	GER
	PERRA Arianna Carlotta	ITA
	KYRYLIUK Tetiana	POL
	KISSENISKY Maddy	GBR
	JESIONEK Maria	POL
	HARDENBERG Janine	GER

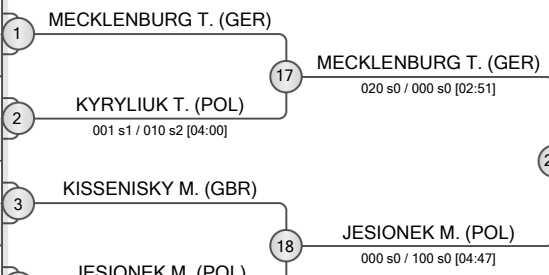

POOL B

	HODSON Lola	GBR
	NETTESHEIM Charlotte	GER
	JAKOBCZYK Maria	POL
	VAN LEEUWEN Emma	NED
	BUSAUSKAITE Migle	LTU
	ROZENBAUM Magdalena	POL

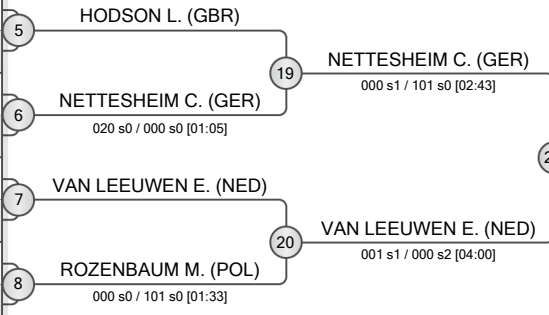

POOL C

	WANDEL Vera	NED
	GOGUA Maria Eleni	GRE
	GALEK Martyna	POL
	SLAZOK Wiktoria	POL
	ERTEN Klara	GER
	CHRISTODOULIDOU Adamantia	CYP

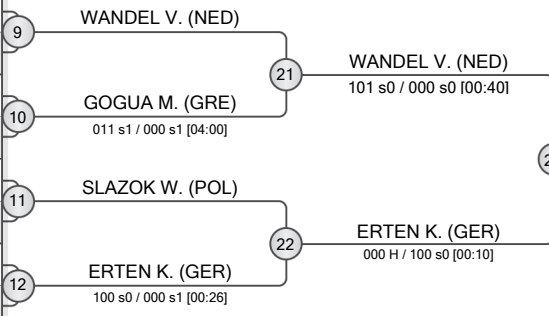

POOL D

	GUETH Nina	GER
	NOWOSAD Roza	POL
	LUIS Shanice	NED
	GRZESZCZYK Otylia	POL
	KORCAKOVA Marketa	CZE

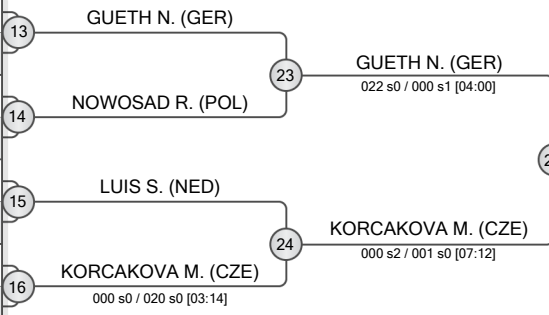

FINAL RESULTS	
1.	MECKLENBURG Tabea Nika GER
2.	ERTEN Klara GER
3.	HODSON Lola GBR
3.	WANDEL Vera NED
5.	GUETH Nina GER
7.	JESIONEK Maria POL
7.	KORCAKOVA Marketa CZE

REPECHAGE

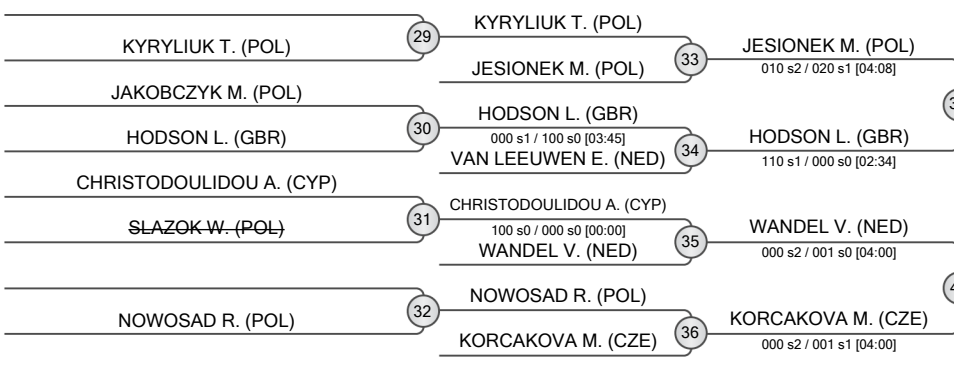



Poznan Junior European Cup 2025

Poland, Poznan, 5-6 Apr 2025

-57 kg
Women (25)

POOL A

	CHMIELEWSKA Kinga	POL
	BANNISTER Callie	AUS
	RICHTER Miu	GER
	KOLAKOWSKA Zuzanna	POL
	NOUFAL Noor	NED
	CZUPKOWSKA Liwia	POL
	KRAUSE Kathrin	GER

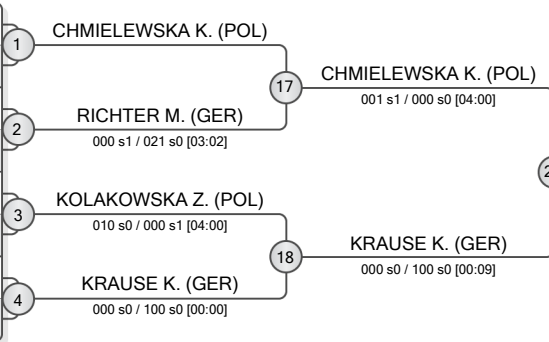

POOL B

	BULANDA Julia	POL
	COLBERS Marlouk	NED
	HALCINOVA Eliska	SVK
	JENMAN Charlotte	GBR
	KOSTER Skadi	GER
	JANUSZ Urszula	POL

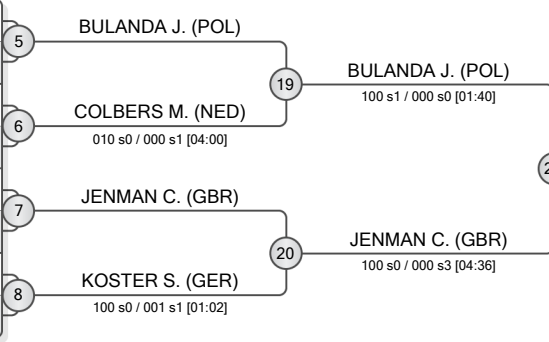

POOL C

	BIRRI Madeleine	GBR
	WICKERT Leonie	GER
	ZOZULINSKA Kalina	POL
	HENSEN Faye	NED
	CAPEZZUTO Martina	ITA
	WALEGA Magdalena	POL

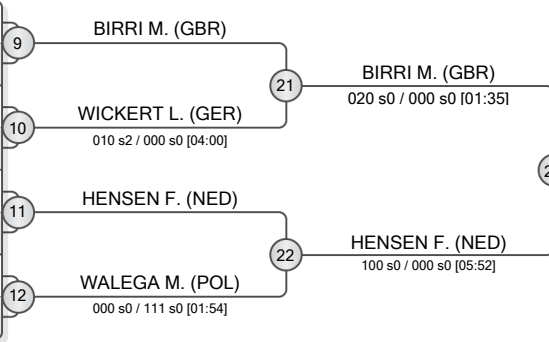

POOL D

	LINK Chloe	GBR
	PATANE Maya	GER
	ZELEK Zuzanna	POL
	RIEGERT Helene	GER
	RUSTIGE Elise	NED
	SZOPA Martyna	POL

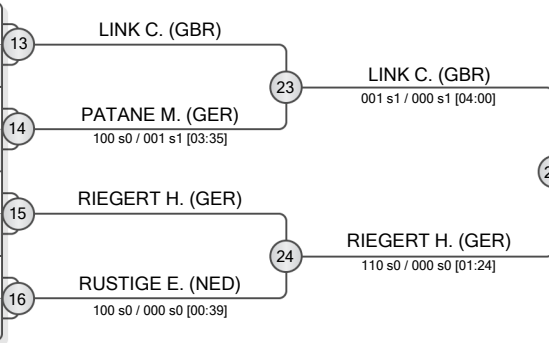

REPECHAGE

29 RICHTER M. (GER)	30 KOSTER S. (GER)	31 WALEGA M. (POL)	32 RUSTIGE E. (NED)
33 KRAUSE K. (GER)	34 BULANDA J. (POL)	35 BIRRI M. (GBR)	36 LINK C. (GBR)

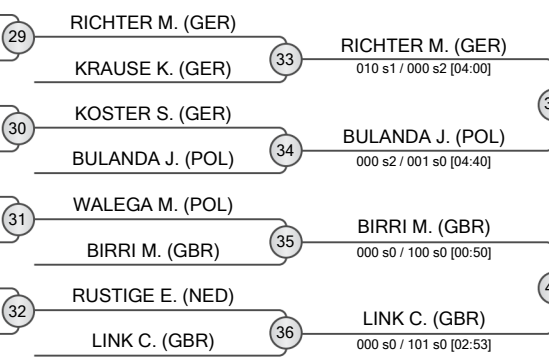

FINAL RESULTS	
1. RIEGERT Helene	GER
2. CHMIELEWSKA Kinga	POL
3. BULANDA Julia	POL
3. LINK Chloe	GBR
5. HENSEN Faye	NED
7. JENMAN Charlotte	GBR
7. RICHTER Miu	GER
7. BIRRI Madeleine	GBR





Poznan Junior European Cup 2025

Poland, Poznan, 5-6 Apr 2025

-63 kg
Women (27)

POOL A

	TOMANKOVA Lenka	SVK
	ZABLOCKA Krystyna	POL
	MUELLER Katharina	GER
	SIRINIDOU Galini	GRE
	PTASINSKA Amelia	POL
	CECHOVA Veronika	CZE
	SCHWARZENBERG Julia	GER

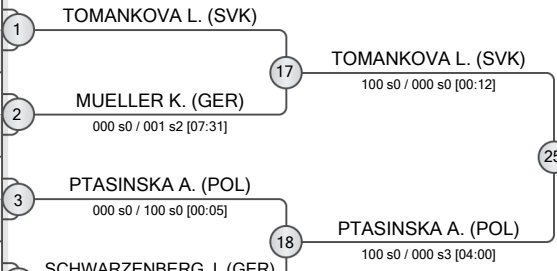

POOL B

	HANGYI Eva	NED
	ECKMANN Greta	GER
	GAZECKA Pola	POL
	DELAHUNTY Olivia	GBR
	TATAJ Julia	POL
	NOERSKOV Mai	DEN

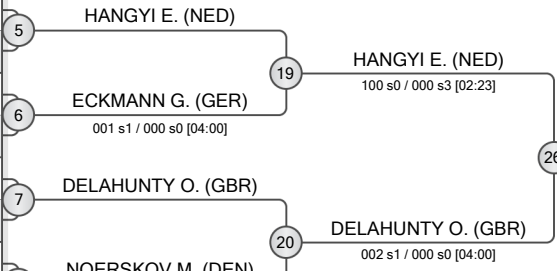

POOL C

	HOGARTH Estela	AUS
	SEMOUD Luna	GER
	WOZNICZKO Nadia	POL
	KUCHAR Varvara	LTU
	KUZMINSKA Oliwia	POL
	OFFENBERG Leah	NED
	AUMANN Felizitas	GER

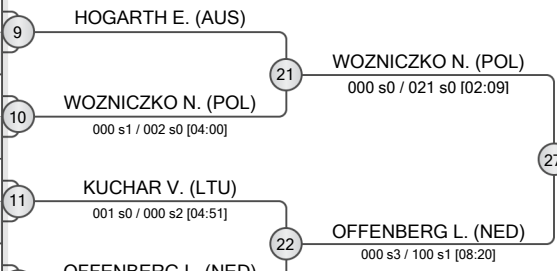

POOL D

	GARLAND Marley	GER
	WOZNIAK Urszula	POL
	VASILIOU Sofia	CYP
	BAGNIEWSKA Amelia	POL
	STEINEBRUNNER Salome	GER
	SIENICKA Antonina	POL
	DRDAKOVA Martina	SVK

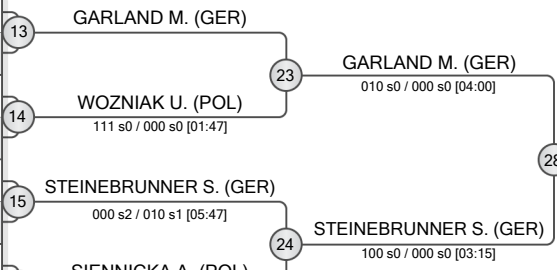

FINAL RESULTS	
1.	WOZNICZKO Nadia (POL)
2.	TOMANKOVA Lenka (SVK)
3.	PTASINSKA Amelia (POL)
3.	STEINEBRUNNER Salome (GER)
5.	GARLAND Marley (GER)
7.	DELAHUNTY Olivia (GBR)
7.	SEMOUD Luna (GER)

REPECHAGE

MUELLER K. (GER)	29	MUELLER K. (GER)	33	PTASINSKA A. (POL)
ECKMANN G. (GER)	30	DELAHUNTY O. (GBR)	34	DELAHUNTY O. (GBR)
SEMOUD L. (GER)	31	SEMOUD L. (GER)	35	SEMOUD L. (GER)
HOGARTH E. (AUS)	31	OFFENBERG L. (NED)	35	SEMOUD L. (GER)
WOZNIAK U. (POL)	32	WOZNIAK U. (POL)	36	STEINEBRUNNER S. (GER)
WOZNIAK U. (POL)	32	STEINEBRUNNER S. (GER)	36	STEINEBRUNNER S. (GER)

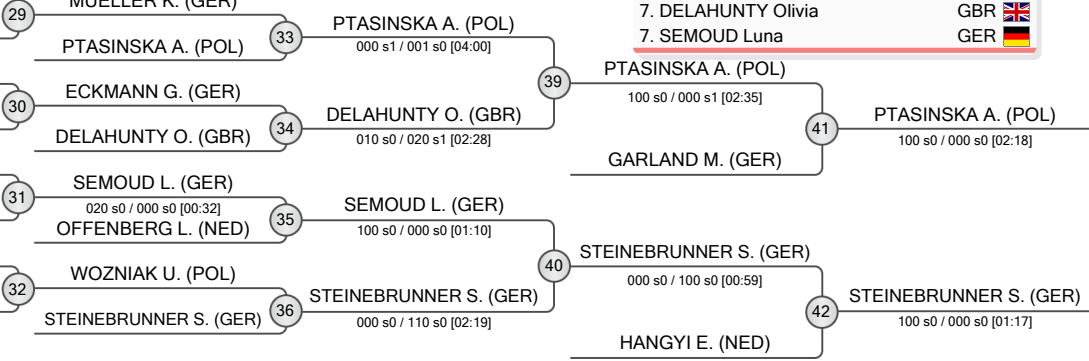



Poznan Junior European Cup 2025

Poland, Poznan, 5-6 Apr 2025

-70 kg

Women (33)

POOL A

1	PAPAGIANNAKI Alexandra (GRE)	PAPAGIANNAKI A. (GRE)
2	SCHIPPER Yael (NED)	SCHIPPER Y. (NED) 33
3	MUELLER Hannah (GER)	MUELLER H. (GER)
4	PIECHNA Olga (POL)	PIECHNA O. (POL) 34
5	POGOSYAN Gayane (EST)	POGOSYAN G. (EST)
6	WITKOWSKA Wiktoria (POL)	WITKOWSKA W. (POL) 35
7	SKORUPINSKA Martyna (POL)	SKORUPINSKA M. (POL)
8	BAUR Coco-Mia (GER)	BAUR C. (GER) 36

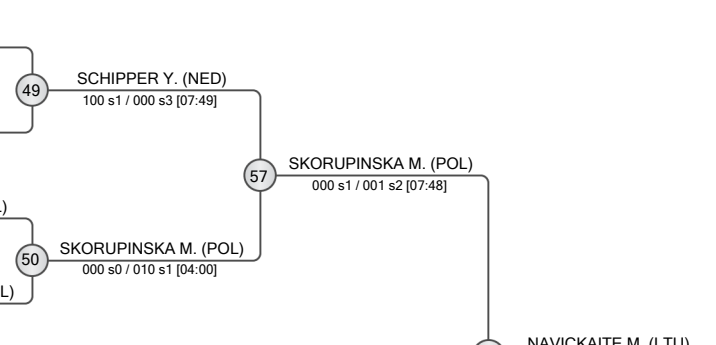

POOL B

9	GLUBIAK Magda (POL)	GLUBIAK M. (POL)
10	THIELE Alica (GER)	THIELE A. (GER) 37
11	BENKOVA Diana (POL)	BENKOVA D. (POL)
12	DE KOCK Luna (NED)	DE KOCK L. (NED) 38
13	NAVICKAITE Marta (LTU)	NAVICKAITE M. (LTU)
14	NEMCOVA Barbora (CZE)	NEMCOVA B. (CZE) 39
15	PIETRZAK Gabriela (POL)	MICIC U. (BIH) 40
16	MICIC Una (BIH)	NEUMANN M. (GER) 40
16	NEUMANN Malin (GER)	NEUMANN M. (GER) 40

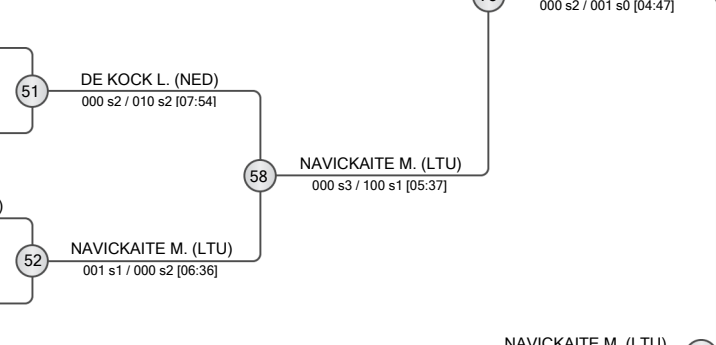

POOL C

17	MARCZAK Julia (POL)	MARCZAK J. (POL)
18	JONGSTRA Anmar (NED)	JONGSTRA A. (NED) 41
19	WINTER Leya (GER)	WINTER L. (GER)
20	SCHENK Magdalena (POL)	SCHENK M. (POL) 42
21	XANTHOPOULOU Sofia (GRE)	XANTHOPOULOU S. (GRE)
22	KNAFELC Noeli (SLO)	KNAFELC N. (SLO) 43
23	ZYS Rokšana (POL)	ZYS R. (POL)
24	KONRAD Sveyarike (GER)	KONRAD S. (GER) 44

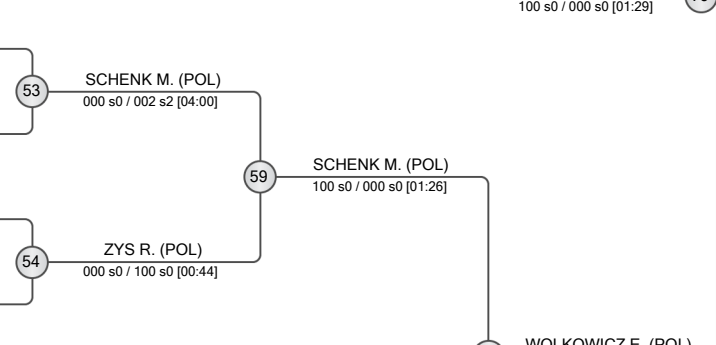

POOL D

25	VERDONK Aloha (NED)	VERDONK A. (NED)
26	PRESTIN Jara (GER)	PRESTIN J. (GER) 45
27	KORDEL Vilja (SWE)	KORDEL V. (SWE)
28	WOLKOWICZ Emilia (POL)	WOLKOWICZ E. (POL) 46
29	LISTL Emma (GER)	LISTL E. (GER)
30	OLSZEWSKA Kinga (POL)	OLSZEWSKA K. (POL) 47
31	SIMUNKOVA Adela (CZE)	SIMUNKOVA A. (CZE)
32	JONGSTRA Luca (NED)	JONGSTRA L. (NED) 48

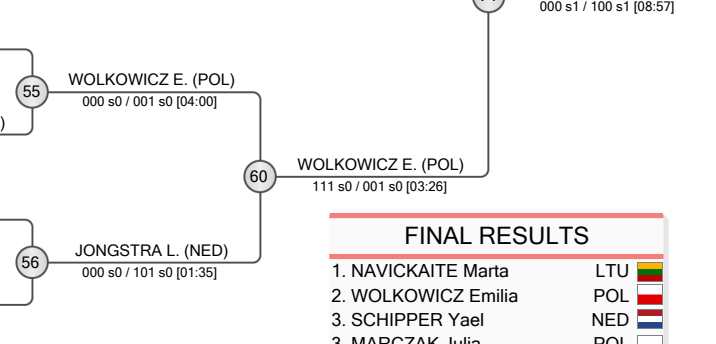

FINAL RESULTS		
1.	NAVICKAITE Marta	LTU
2.	WOLKOWICZ Emilia	POL
3.	SCHIPPER Yael	NED
3.	MARCZAK Julia	POL
5.	SCHENK Magdalena	POL
7.	SKORUPINSKA Martyna	POL
7.	NEMCOVA Barbora	CZE
7.	VERDONK Aloha	NED

REPECHAGE

61	BAUR C. (GER)	BAUR C. (GER)
62	NEMCOVA B. (CZE)	NEMCOVA B. (CZE) 66
63	WINTER L. (GER)	WINTER L. (GER)
64	KORDEL V. (SWE)	KORDEL V. (SWE)
65	WITKOWSKA W. (POL)	WITKOWSKA W. (POL) 65
66	NEUMANN M. (GER)	NEUMANN M. (GER) 66
67	MARCZAK J. (POL)	MARCZAK J. (POL) 67
68	VERDONK A. (NED)	VERDONK A. (NED) 68
69	SCHIPPER Y. (NED)	SCHIPPER Y. (NED) 69
70	DE KOCK L. (NED)	DE KOCK L. (NED) 70
71	ZYS R. (POL)	ZYS R. (POL) 71
72	JONGSTRA L. (NED)	JONGSTRA L. (NED) 72

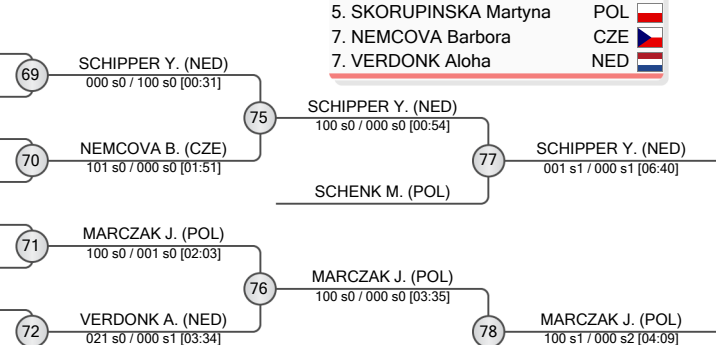



Poznan Junior European Cup 2025

Poland, Poznan, 5-6 Apr 2025

-78 kg

Women (11)

POOL A

	HANSTED E Maria	NED
	WIDLAK Nicole	POL
	MANUKYAN Mia	GER

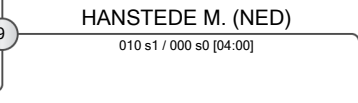
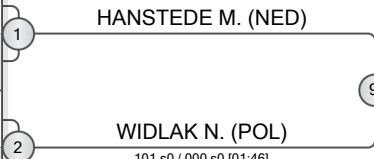

POOL B

	WOOD Nicole	GBR
	HOJDAROVA Stepanka	CZE

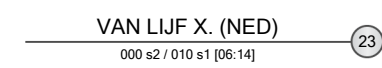
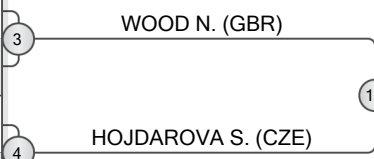

POOL C

	PAJIC Sofija	BIH
	HARTMEIJER Lindy	NED
	PIKOSZ Nicole	POL

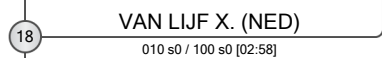
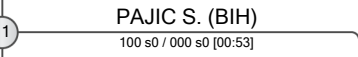
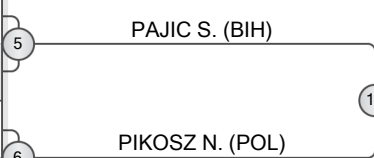

POOL D

	HASSAN Anya	GBR
	SCHREIBER Zyna	GER
	VAN LIJF Xanne	NED

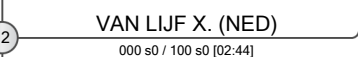
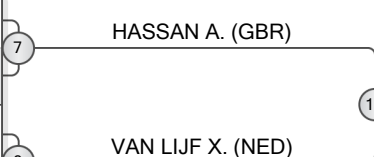

FINAL RESULTS		
1.	VAN LIJF Xanne	NED
2.	HANSTED E Maria	NED
3.	PAJIC Sofija	BIH
3.	HOJDAROVA Stepanka	CZE
5.	WOOD Nicole	GBR
5.	SCHREIBER Zyna	GER
7.	WIDLAK Nicole	POL
7.	PIKOSZ Nicole	POL

REPECHAGE

13	WIDLAK N. (POL)
14	WOOD N. (GBR)
15	PIKOSZ N. (POL)
16	SCHREIBER Z. (GER)
16	HASSAN A. (GBR)

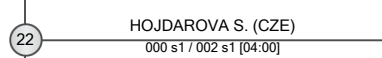
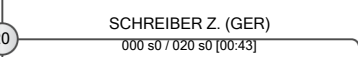
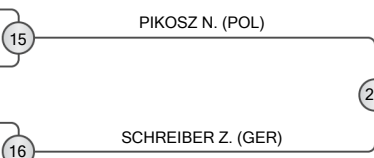
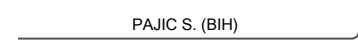
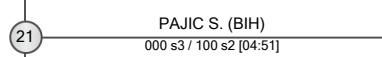
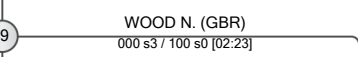
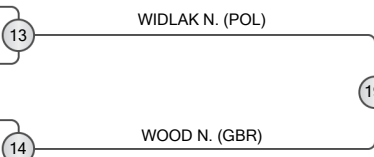



Poznan Junior European Cup 2025

Poland, Poznan, 5-6 Apr 2025

+ 78 kg

Women (6)

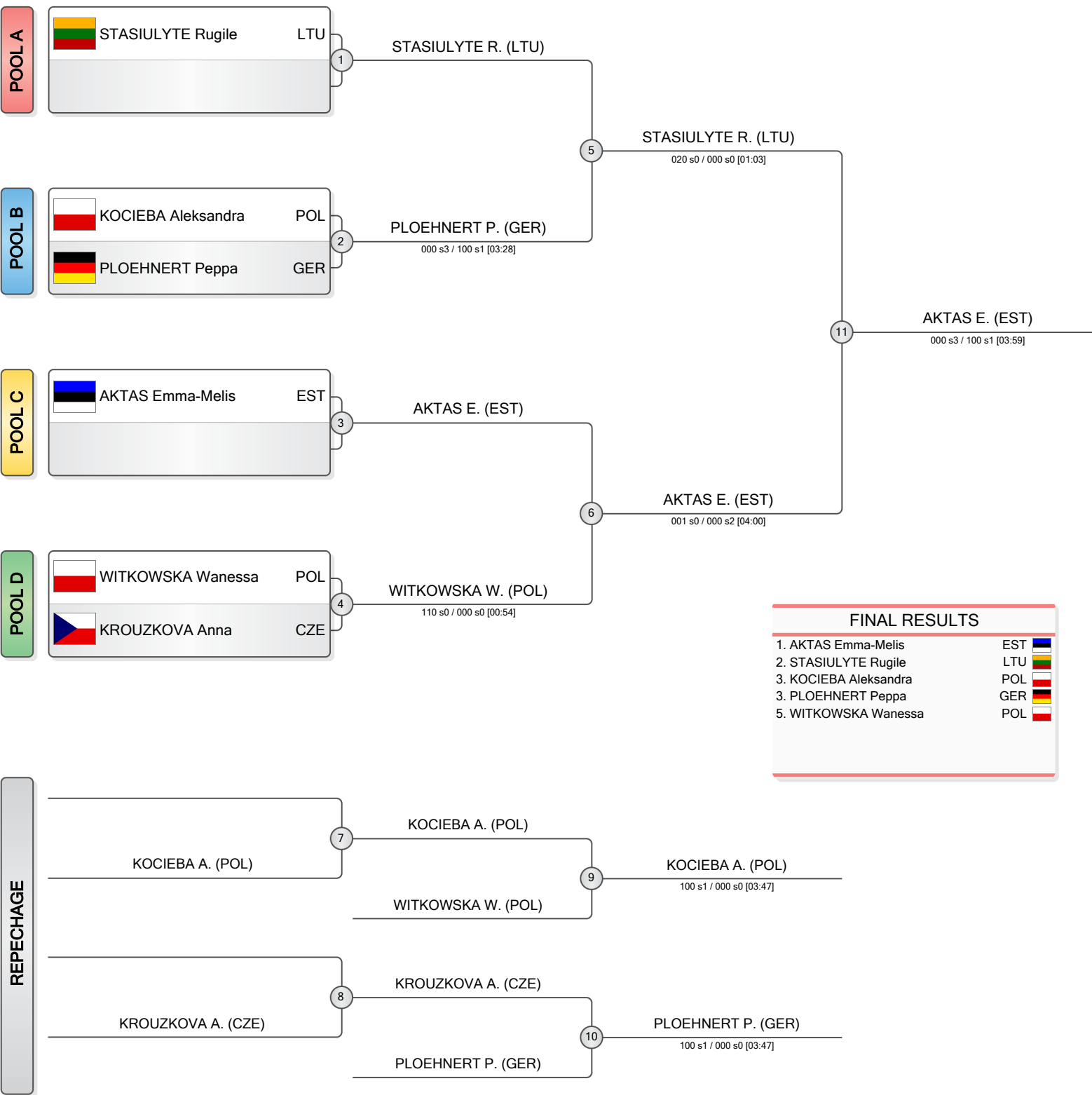

FINAL RESULTS	
1. AKTAS Emma-Melis	EST
2. STASIULYTE Rugile	LTU
3. KOCIEBA Aleksandra	POL
3. PLOEHNERT Peppa	GER
5. WITKOWSKA Wanessa	POL

