



Event Report

Poznan Junior European Cup 2025, 5-6 Apr 2025

Event Report

412 competitors from 23 nations

272 Men

140 Women

66,02%

33,98%

-60 kg	-66 kg	-73 kg	-81 kg	-90 kg	-100 kg	+100 kg	Men
31	58	57	52	36	23	15	272

-48 kg	-52 kg	-57 kg	-63 kg	-70 kg	-78 kg	+78 kg	Women
15	23	25	27	33	11	6	140

Continent	AJU	JUA	EJU	OJU	PJC	OTH	Total
Nations		1	21	1			23
Competitors		3	405	4			412

Schedule		
Date	5 Apr	6 Apr
Start	09:00	09:00
End	17:45	15:50
Finals start	18:15	16:19
Finals end	20:30	20:00



Poznan Junior European Cup 2025

Poland, Poznan, 5-6 Apr 2025

Men
Final results

-60 kg		
1	GARAYEV Farid	AZE
2	ASHPIZ Izhak	ISR
3	MAMISHOV Nihad	AZE
3	MUNIZ ACOSTA Jakub	POL
5	NAVON Maayan	ISR
5	KAMINSKY Andriy	UKR
7	AYRE Charlie	GBR
7	TAMARY Ben	ISR

-66 kg		
1	MUSAYEV Mahammad	AZE
2	RICHARDSON Luca	NED
3	POLIKEVICIUS Simas	LTU
3	KRAVCHENKO Danylo	UKR
5	LAURITZEN Magni	DEN
5	IVTCHENKO Marc	GER
7	KLODA Gal	ISR
7	SHERER Ziv	ISR

-73 kg		
1	GOGINASHVILI Irakli	GBR
2	VARDANIAN Narek	SWE
3	YUSUBOV Abil	AZE
3	MOLOSHYK Danylo	UKR
5	AKOTO Raphael	GER
5	LEVY Benjamin	GBR
7	BULOCINIC Tom	ISR
7	MARLOV Alexander	SWE

-81 kg		
1	TARKOWSKI Fabrycjusz	POL
2	SHUKUROV Suleyman	AZE
3	FRIDMAN ZILBERSTEIN Reem	ISR
3	AVDEJEVS Aleksandrs	LAT
5	KOCZINSKI Arel	ISR
5	IBADLI Jasur	AZE
7	PLOSTNIEKS Ronalds	LAT
7	BALAMPANIDIS Iraklis	GRE

-90 kg		
1	MARCZAK Derek	POL
2	SHAMIL Tuncay	AZE
3	NEDERBRAGT Bram	NED
3	SOKYRKO Serhii	UKR
5	BRESLER Yonatan	ISR
5	BRAZANI Gal	ISR
7	SPRYDONOV Daniil	GER
7	PACARIZ Armin	GER

-100 kg		
1	YUDANOV Nikita	UKR
2	BUTIJER Borna	CRO
3	WACKO Mateusz	POL
3	MARCIN Walenciak	POL
5	WALENCIAK Michal	POL
5	TESMAR Mateusz	POL
7	DUIKER Redmer	NED
7	LEBID Dmytro	UKR

+100 kg		
1	AHMADOV Ramazan	AZE
2	SUHA Mortaza	GER
3	OMELCHENKO Yaroslav	UKR
3	MASAK Marek-Adrian	EST
5	FESENKO Oleh	UKR
5	BALLERING Martinus	NED
7	ALIYEV Eldar	AZE
7	KHACHATRYAN Anton	POL



Poznan Junior European Cup 2025

Poland, Poznan, 5-6 Apr 2025

Women Final results

-48 kg		
1	TOMANKOVA Patricia	SVK
2	HABIB Helen	GER
3	RIKMANSPOEL Maud	NED
3	TWAROWSKA Barbara	POL
5	HOEKSTRA Robin	NED
5	STOFBERG Lara	NED
7	GHAFFAR Asal	GER
7	KOZUCH Oliwia	POL

-52 kg		
1	MECKLENBURG Tabea Nika	GER
2	ERTEN Klara	GER
3	HODSON Lola	GBR
3	WANDEL Vera	NED
5	GUETH Nina	GER
5	NETTESHEIM Charlotte	GER
7	JESIONEK Maria	POL
7	KORCAKOVA Marketa	CZE

-57 kg		
1	RIEGERT Helene	GER
2	CHMIELEWSKA Kinga	POL
3	BULANDA Julia	POL
3	LINK Chloe	GBR
5	HENSEN Faye	NED
5	JENMAN Charlotte	GBR
7	RICHTER Miu	GER
7	BIRRI Madeleine	GBR

-63 kg		
1	WOZNICZKO Nadia	POL
2	TOMANKOVA Lenka	SVK
3	PTASINSKA Amelia	POL
3	STEINEBRUNNER Salome	GER
5	GARLAND Marley	GER
5	HANGYI Eva	NED
7	DELAHUNTY Olivia	GBR
7	SEMOUD Luna	GER

-70 kg		
1	NAVICKAITE Marta	LTU
2	WOLKOWICZ Emilia	POL
3	SCHIPPER Yael	NED
3	MARCZAK Julia	POL
5	SCHENK Magdalena	POL
5	SKORUPINSKA Martyna	POL
7	NEMCOVA Barbora	CZE
7	VERDONK Aloha	NED

-78 kg		
1	VAN LIJF Xanne	NED
2	HANSTEDDE Maria	NED
3	PAJIC Sofija	BIH
3	HOJDAROVA Stepanka	CZE
5	WOOD Nicole	GBR
5	SCHREIBER Zyna	GER
7	WIDLAK Nicole	POL
7	PIKOSZ Nicole	POL

+78 kg		
1	AKTAS Emma-Melis	EST
2	STASIULYTE Rugile	LTU
3	KOCIEBA Aleksandra	POL
3	PLOHNERT Peppa	GER
5	WITKOWSKA Wanessa	POL



Medals

Poznan Junior European Cup 2025, 5-6 Apr 2025

Medals

Nations: 15

#	Nation	1. Place	2. Place	3. Place	5. Place	7. Place
1.	POL Poland	3	2	8	5	5
2.	AZE Azerbaijan	3	2	2	1	1
3.	GER Germany	2	3	2	6	5
4.	NED Netherlands	1	2	4	5	2
5.	LTU Lithuania	1	1	1		
6.	SVK Slovakia	1	1			
7.	UKR Ukraine	1		4	2	1
8.	GBR Great Britain	1		2	3	3
9.	EST Estonia	1		1		
10.	ISR Israel		1	1	4	4
11.	SWE Sweden		1			1
12.	CRO Croatia		1			
13.	CZE Czechia			1		2
14.	LAT Latvia			1		1
15.	BIH Bosnia and Herzegovina			1		
16.	DEN Denmark				1	
17.	GRE Greece					1

Official person:



Statistics

Poznan Junior European Cup 2025, 5-6 Apr 2025

Statistics

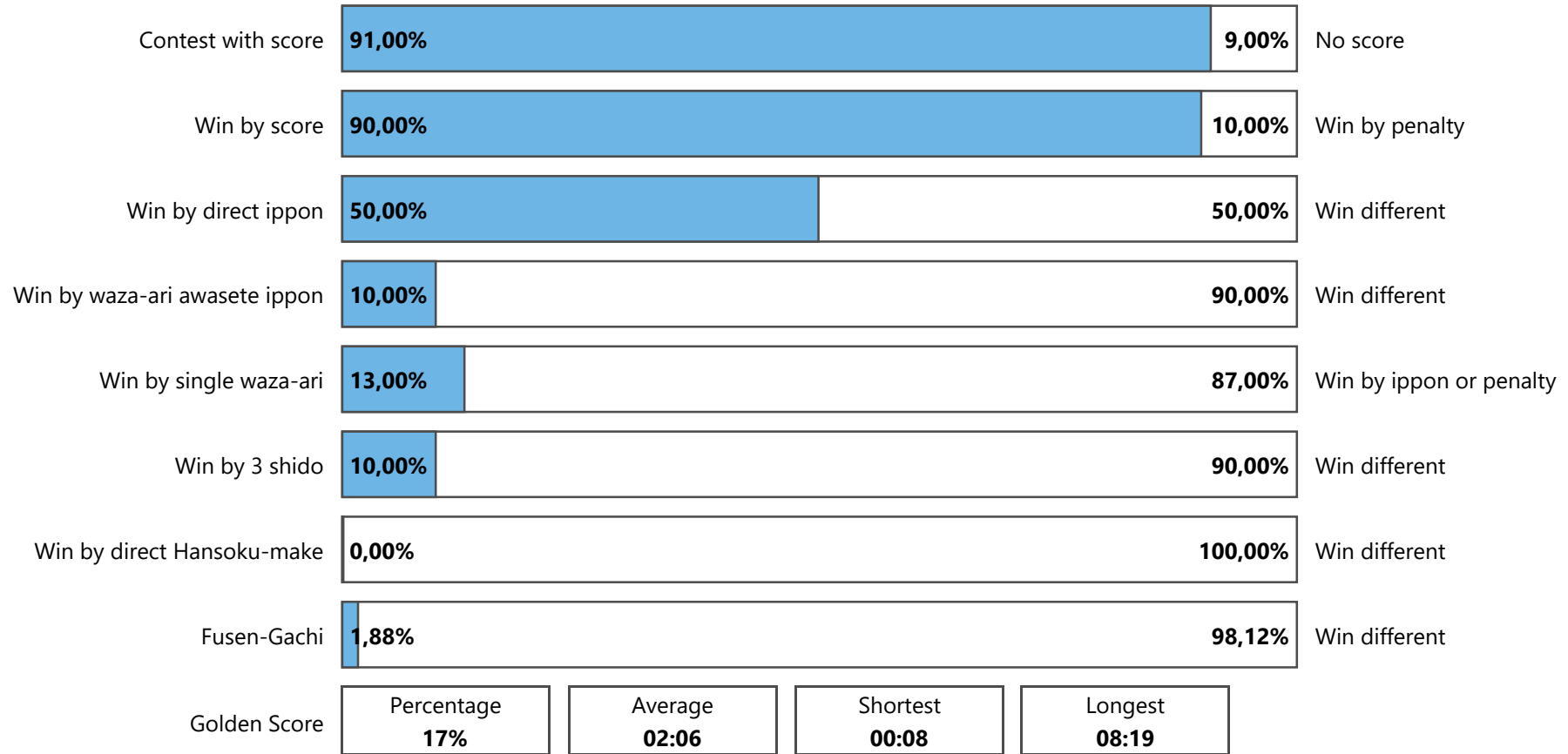



Statistics

Poznan Junior European Cup 2025, 5-6 Apr 2025

Statistics

	-60	-66	-73	-81	-90	-100	+100	M	-48	-52	-57	-63	-70	-78	+78	W	Total
Competitors	31	58	57	52	36	23	15	272	15	23	25	27	33	11	6	140	412
Contests	42	70	70	64	48	31	21	346	21	32	32	35	44	15	7	186	532
Wins by Score	37	61	64	56	46	28	19	311	19	29	29	31	42	13	4	167	478
Wins by Score %	88	87	91	88	96	90	90	89,88	90	91	91	89	95	87	57	89,78	90
Wins by Penalty	5	9	6	8	2	3	2	35	2	3	3	4	2	2	3	19	54
Wins by Penalty %	12	13	9	12	4	10	10	10,12	10	9	9	11	5	13	43	10,22	10
Wins by direct Ippon %	50	49	39	61	56	58	67	52,02	52	41	47	46	57	40	29	47,31	50
Wins by Waza-ari Awasete Ippon %	10	10	11	8	12	10	14	10,40	10	19	6	9	5	7	14	9,14	10
Wins by Waza-ari %	12	14	20	11	10	3	0	12,14	10	19	22	11	11	27	0	15,05	13
Wins by Yuko %	17	14	21	8	17	19	10	15,32	19	12	16	23	23	13	14	18,28	16
Wins by 3 Shido for opponent %	12	13	9	12	4	10	10	10,12	10	6	9	11	5	13	43	9,68	10
Wins by direct Hansoku-make %	0	0	0	0	0	0	0	0	0	3	0	0	0	0	0	0	0
Double HSK %	0	0	0	0	0	0	0	0	0	0	0	0	0	0	0	0	0
All positive Scores (Yuko + Waza-ari + direct Ippon)	53	100	93	96	67	47	31	487	27	48	40	44	61	19	6	245	732
Average Scores per contests	12	13	9	12	4	10	10	1,41	10	9	9	11	5	13	43	1,32	10
Contests with score %	88	87	93	91	96	90	90	90,75	90	91	91	91	95	87	57	90,32	91
All penalties (Shido + HSK)	60	100	104	95	55	54	29	497	27	37	35	33	42	18	16	208	705
Average penalty per contest	1,43	1,43	1,49	1,48	1,15	1,74	1,38	1,44	1,29	1,16	1,09	0,94	0,95	1,2	2,29	1,12	1,33
Contests with only penalty %	12	13	7	9	4	10	10	9,25	10	9	9	9	5	13	43	9,68	9
Number of Osae-komi (Absolute)	11	9	9	10	7	6	8	60	7	11	6	11	14	9	2	60	120
Osae-komi no score %	36,36	22,22	22,22	40,0	42,86	33,33	12,50	30,0	28,57	18,18	66,67	36,36	21,43	55,56	0	33,33	31,67
Osae-komi Yuko %	27,27	33,33	11,11	30,0	28,57	0	0	3,47	0	9,09	16,67	18,18	14,29	0	0	3,23	15,00
Osae-komi Waza-ari %	18,18	22,22	55,56	30,0	28,57	33,33	50,0	5,78	14,29	45,45	16,67	18,18	14,29	11,11	100	7,53	28,33
Osae-komi Ippon %	18,18	22,22	11,11	0	0	33,33	37,50	2,89	57,14	27,27	0	27,27	50,0	33,33	0	10,75	25,00
Direct Hansoku-make	0	0	0	0	0	0	0	0	0	1	0	0	0	0	0	1	1
Fusen-gachi	5	0	0	1	2	0	0	8	0	1	1	0	0	0	0	2	10
Doctor call	1	0	9	1	4	0	0	15	1	3	1	2	0	0	0	7	22
Golden Score %	19	19	26	11	19	13	10	17,63	10	19	16	14	25	13	14	17,20	17
Golden Score Duration AVG	146,12	147,38	103,72	100,43	101,56	149,75	164,5	122,90	94,5	74,33	180,2	162,4	154,36	92,5	70	134,41	126,86
Golden Score Duration MAX	499	457	296	217	258	277	246	499	111	192	379	260	297	134	70	379	499



Nations Overview

Poznan Junior European Cup 2025, 5-6 Apr 2025

Nations

Overview

			-60	-66	-73	-81	-90	-100	+10	M	-48	-52	-57	-63	-70	-78	+78	W	Total	Ref	D	
1.		AUS	Australia	1	1					2			1	1				2	4	0	1	
2.		AZE	Azerbaijan	2	2	2	2	2	1	2	13							0	13	0	4	
3.		BIH	Bosnia and Herzegovina							0					1	1		2	2	0	1	
4.		CRO	Croatia					1		1								0	1	0	1	
5.		CYP	Cyprus	1		1				2		1		1				2	4	0	1	
6.		CZE	Czechia	1	3	3	4	3	2	1	17	1	1		1	2	1	1	7	24	0	4
7.		DEN	Denmark		2	1				3				1				1	4	0	1	
8.		EST	Estonia	1	2		1		1	5					1		1	2	7	0	3	
9.		FIN	Finland			1	1			2								0	2	0	1	
10.		GBR	Great Britain	1	1	6	3	2		13	1	2	3	1		2		9	22	2	12	
11.		GER	Germany	3	8	9	4	5	3	3	35	2	5	6	7	8	2	1	31	66	3	13
12.		GRE	Greece		1		2		1	4		1		1	2			4	8	0	2	
13.		ISR	Israel	5	6	3	4	3	2	23								0	23	1	2	
14.		ITA	Italy	1						1		1	1					2	3	0	2	
15.		KGZ	Kyrgyzstan	1		1	1			3								0	3	0	1	
16.		LAT	Latvia			1	3	2	1	7								0	7	0	2	
17.		LTU	Lithuania		3	1	3			7		1		1	1		1	4	11	0	2	
18.		NED	Netherlands	4	6	4	4	2	2	1	23	4	3	4	2	5	3	21	44	1	10	
19.		POL	Poland	7	15	18	10	12	6	3	71	6	8	9	9	11	2	2	47	118	6	54
20.		SLO	Slovenia							0					1			1	1	0	1	
21.		SVK	Slovakia	1	2	2	1		1	7	1		1	2				4	11	0	3	
22.		SWE	Sweden		2	2	2			6					1			1	7	1	4	
23.		UKR	Ukraine	2	4	2	7	5	3	4	27							0	27	0	5	
				31	58	57	52	36	23	15	272	15	23	25	27	33	11	6	140	412	14	130

Total: 412 competitors from 23 countries and 3 continents



Poznan Junior European Cup 2025

Poland, Poznan, 5-6 Apr 2025

-60 kg

Men (31)

POOL A

	TOMANEK Jozef	SVK
	MAMISHOV Nihad	AZE
	BIEDRZYCKI Hubert	POL
	MEHDITACHE Ido	ISR
	SMEJKAL Stepan	CZE
	WALINGA Ruben	NED
	KAMINSKY A. Andriy	UKR

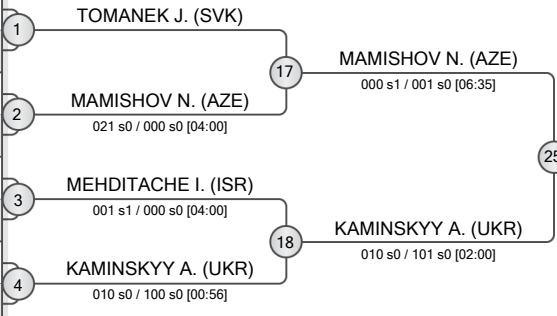

POOL B

	AYRE Charlie	GBR
	KORNATKA Kacper	POL
	TSJKADOEA Luca	NED
	SHCHEKOTIN Filipp	EST
	ASHPIZ Izhak	ISR
	OROZMAMATOV Adis	KGZ
	KOLONDR A. Jan	POL
	SCHLEER Joris	GER

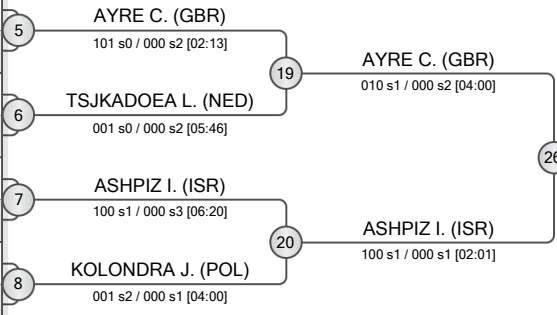

POOL C

	LEE Casey	AUS
	GARAYEV Farid	AZE
	CABECANA Luke	GER
	PIECHOTA Stanislaw	POL
	SHENKMAN Tal	ISR
	GUIKEMA Michel	NED
	SANNA Riccardo	ITA
	MUNIZ ACOSTA Jakub	POL

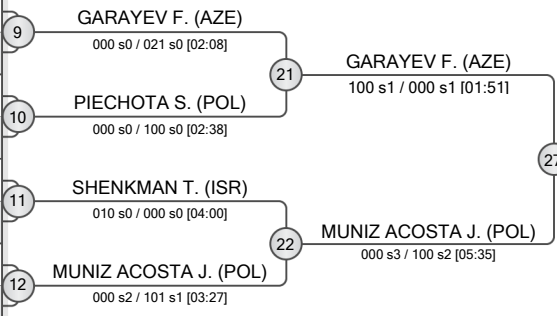

POOL D

	NAVON Maayan	ISR
	SWITALA Pawel	POL
	LOEFFLER Kilian	GER
	BRONSV OORD Jarno	NED
	TAMARY Ben	ISR
	MALIKOV Semen	UKR
	CHARALAMPOUS Stratos	CYP
	PILKA Oleh	POL

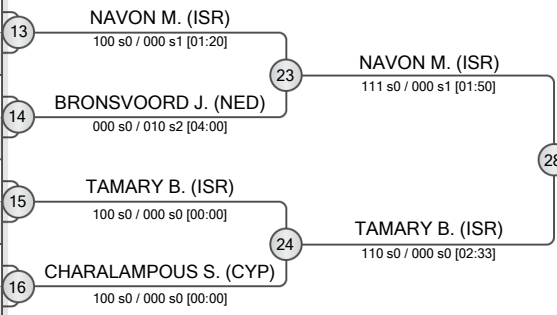

REPECHAGE

29	WALINGA R. (NED)	WALINGA R. (NED)	33	MAMISHOV N. (AZE)
30	MEHDITACHE I. (ISR)	MAMISHOV N. (AZE)	34	AYRE C. (GBR)
31	OROZMAMATOV A. (KGZ)	AYRE C. (GBR)	35	MUNIZ ACOSTA J. (POL)
32	KOLONDR A. J. (POL)	MUNIZ ACOSTA J. (POL)	36	TAMARY B. (ISR)
	LEE C. (AUS)			
	PIECHOTA S. (POL)			
	SWITALA P. (POL)			
	BRONSV OORD J. (NED)			

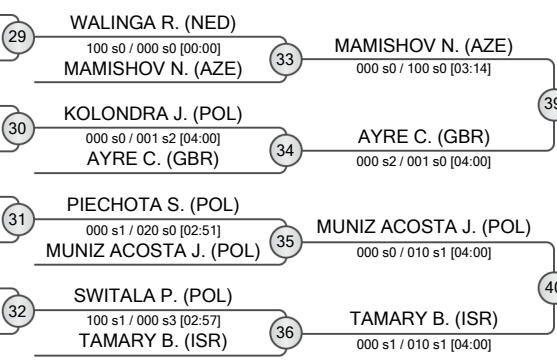

FINAL RESULTS	
1.	GARAYEV Farid (AZE)
2.	ASHPIZ Izhak (ISR)
3.	MAMISHOV Nihad (AZE)
3.	MUNIZ ACOSTA Jakub (POL)
5.	NAVON Maayan (ISR)
5.	KAMINSKY A. Andriy (UKR)
7.	AYRE Charlie (GBR)
7.	TAMARY Ben (ISR)





Poznan Junior European Cup 2025

Poland, Poznan, 5-6 Apr 2025

-66 kg

Men (58)

POOL A

1	KLODA Gal	ISR
2	GABRIEL Igor	POL
3	POBLOCKI Samir	SWE
4	RICHARDSON Luca	NED
5	KELLER Adrian	GER
6	TSUKANOV Nazar	POL
7	JAKIMOV Edward	EST
8	FERENC Wojciech	POL
9	BABICH Vladyslav	UKR
10	ZINK Stepan	CZE
11	RESIAK Marcel	POL
12	COHEN Shalev	ISR
13	HERMSEN Dani	NED
14	DRESE Leonas	GER

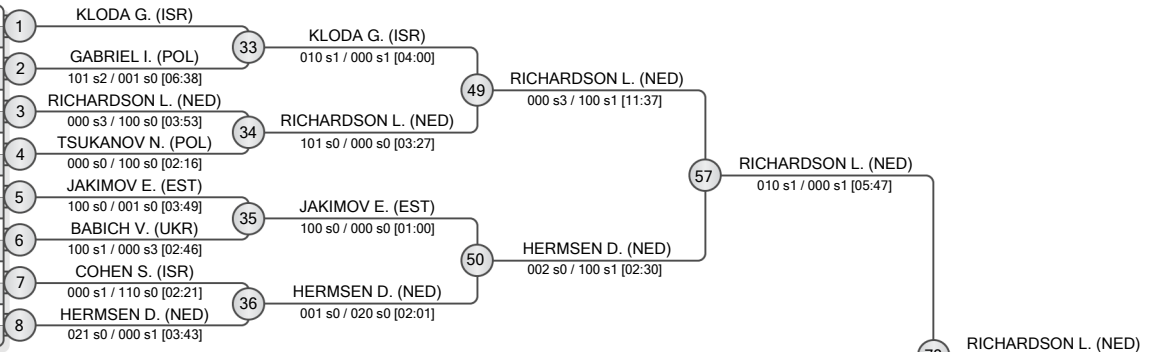

POOL B

9	KRAVCHENKO Danylo	UKR
10	ZEEVI Itamar	ISR
11	KOZLIK Franciszek	POL
12	LAURITZEN Magni	DEN
13	SANDLERMAN Artur	POL
14	BOYUKKISHIYEV Emin	AZE
15	WEGELE Maxim	GER
16	KLOBUCNIK Matej	SVK
17	VELSTRA Si	NED
18	ZEMLA Patryk	POL
19	KASPARAVICIUS Nidijus	LTU
20	SLEDZ Tomasz	POL
21	TSAPARAS Konstantinos	GRE
22	MAKALATIYA Demetres	GER

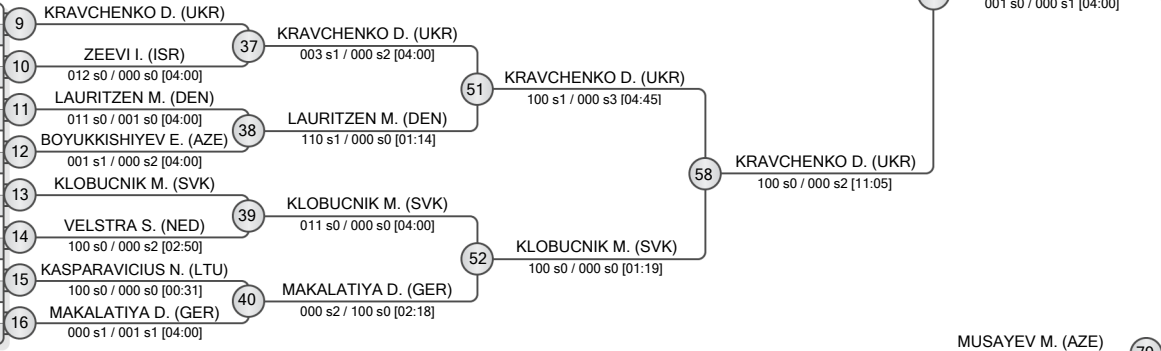

POOL C

17	POLIKEVICIUS Simas	LTU
18	SWIDERSKI Oskar	POL
19	SUSEBEEK Bo	NED
20	VELYKYI Artur	POL
21	LAVI Ori	ISR
22	IVTCHENKO Marc	GER
23	NOERSKOV Oliver	DEN
24	MIDDLETON Vas	AUS
25	KOPECKY Matej	CZE
26	SUR Mihhail	EST
27	SAVCHENKO Maksym	POL
28	SAPUNOV Andrii	POL
29	MARTYNCHUK Oleksandr	UKR
30	KUPPER David	GER
31	FALLAH DAR Rastin	GBR

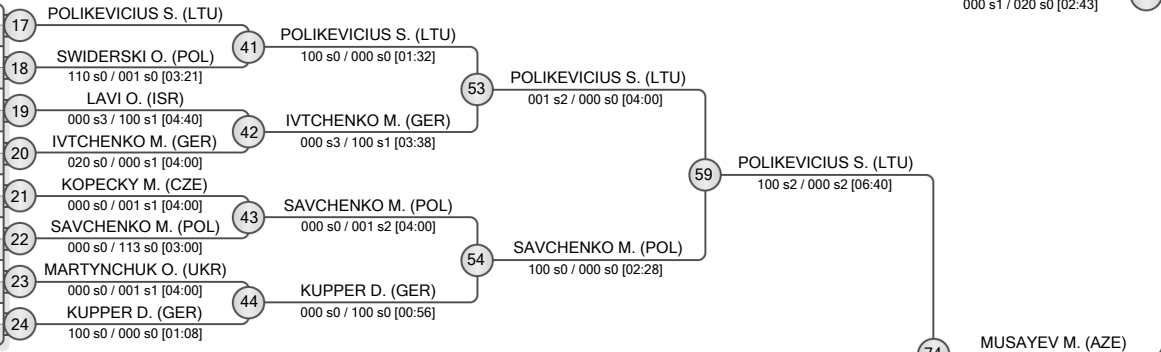

POOL D

25	MUSAYEV Mahammad	AZE
26	ROSU Yarin	ISR
27	ODKLADAL Juraj	SVK
28	DOTSENKO Denys	UKR
29	VREELING Tristan	NED
30	TYMINSKI Maksymilian	POL
31	BALIEV Ramzan	GER
32	SHERER Ziv	ISR
33	FAAS Siebe	NED
34	GRUBELSKI Jakub	POL
35	GHISLER Henry	SWE
36	GAFFARLI Al-Huseyn	GER
37	DERKACZ Marcel	POL
38	GALIA Jan	CZE

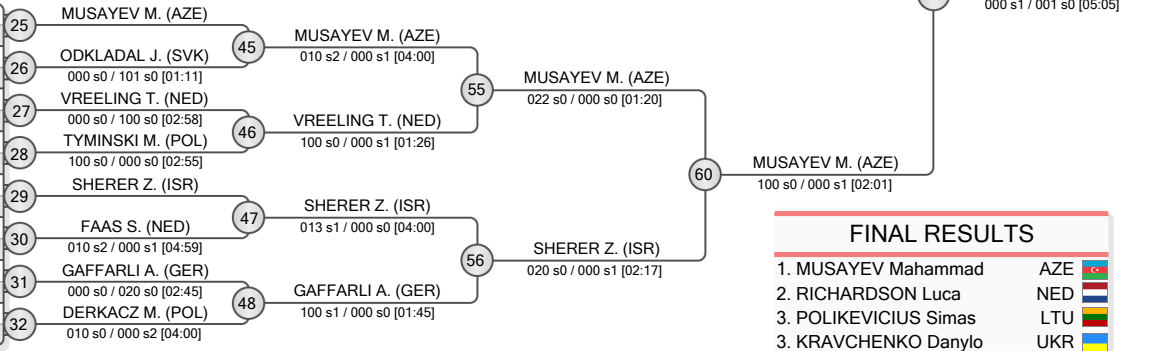

FINAL RESULTS		
1.	MUSAYEV Mahammad	AZE
2.	RICHARDSON Luca	NED
3.	POLIKEVICIUS Simas	LTU
4.	KRAVCHENKO Danylo	UKR
5.	LAURITZEN Magni	DEN
6.	IVTCHENKO Marc	GER
7.	KLODA Gal	ISR
8.	SHERER Ziv	ISR

REPECHAGE

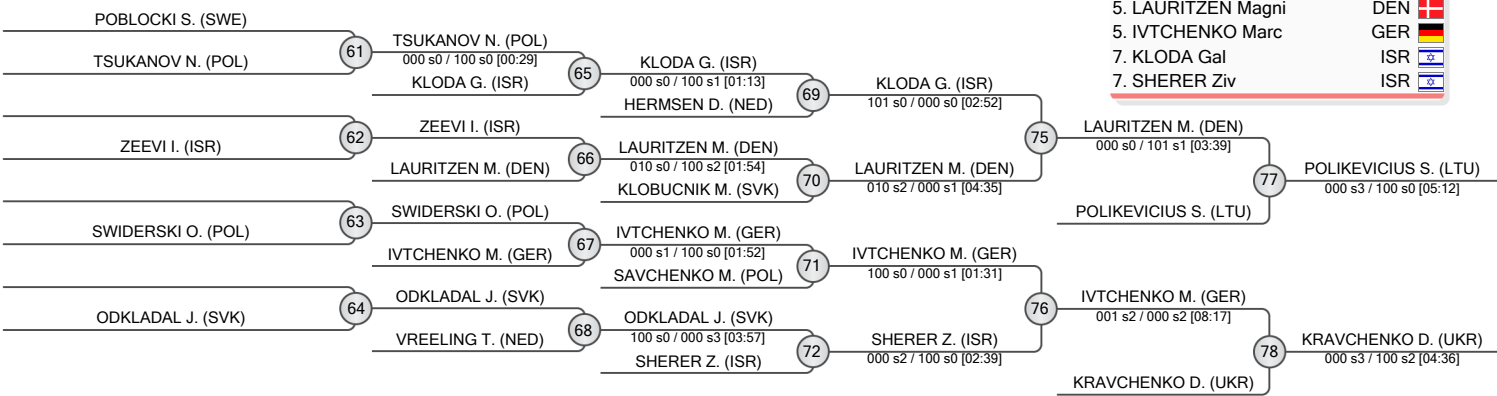



Poznan Junior European Cup 2025

Poland, Poznan, 5-6 Apr 2025

-73 kg

Men (57)

POOL A

AKOPJAN Arthur	GER	1	AKOPJAN A. (GER)
HABZO Ariel	ISR	2	HABZO A. (ISR)
WIWATOWSKI Bartosz	POL	3	AKOTO R. (GER)
AKOTO Raphael	GER	3	AKOTO R. (GER)
FUCHS Pawel	POL	4	BRISUDA S. (SVK)
BRISUDA Samuel	SVK	4	BRISUDA S. (SVK)
RIDOUT Oliver	GBR	5	VARDANIAN N. (SWE)
KAZIMIERCZAK Adam	POL	5	VARDANIAN N. (SWE)
VARDANIAN Narek	SW	6	DAVIES P. (GBR)
DAVIES Peter	GBR	6	DAVIES P. (GBR)
BARSKE Rufus	GER	7	TAAVITSAINEN J. (FIN)
BOGDANSKI Teodor	POL	7	TAAVITSAINEN J. (FIN)
TAAVITSAINEN Jesper	FIN	8	STEFANSKI A. (POL)
POT Daan	NED	8	STEFANSKI A. (POL)
STEFANSKI Adrian	POL		

POOL B

VAN DER VEEN Quinten	NED	9	VAN DER VEEN Q. (NED)
SOBCHENKO Mykhailo	POL	10	MOLOSHYK D. (UKR)
MOLOSHYK Danylo	UKR	10	MOLOSHYK D. (UKR)
CELADINS Nikita	LAT	11	NOACK M. (GER)
JAREMKO Kamil	POL	11	NOACK M. (GER)
RESUTIK Adam	CZE	12	BULOCINIC T. (ISR)
NOACK Melvin	GER	12	BULOCINIC T. (ISR)
BULOCINIC Tom	ISR	13	MUSZYNSKI J. (POL)
MUSZYNSKI Jakub	POL	14	MUSZYNSKI J. (POL)
BIRLUND Aksel	DEN	15	KUSTRZYCKI K. (POL)
KUSTRZYCKI Kamil	POL	15	KUSTRZYCKI K. (POL)
MACLEOD Jack	GBR	16	JAFAROV M. (AZE)
JAFAROV Mehdi	AZE	16	JAFAROV M. (AZE)
HUEPENBECKER Louis	GER		

POOL C

GOGINASHVILI Irakli	GBR	17	GOGINASHVILI I. (GBR)
KOBYLINSKI Jakub	POL	18	JOVSA D. (LTU)
JOVSA Deividas	LTU	18	JOVSA D. (LTU)
QADDOURAH Karim	POL	19	GUENTHER N. (GER)
DEKAN Roman	SVK	19	GUENTHER N. (GER)
PLUTA Pawel	POL	20	MORITZ O. (ISR)
GUENTHER Nouri	GER	20	MORITZ O. (ISR)
MORITZ Ohad	ISR	21	ZITA O. (CZE)
BETKOWSKI Milosz	POL	22	ZITA O. (CZE)
ZITA Ondrej	CZE	22	ZITA O. (CZE)
GOLEDZINOWSKI Jakub	POL	23	LA FONTAINE B. (NED)
LA FONTAINE Basile	NED	23	LA FONTAINE B. (NED)
MARLOV Alexander	SWE	24	MARLOV A. (SWE)
KITAGAWA Alexander	GER	24	MARLOV A. (SWE)

POOL D

LEVY Benjamin	GBR	25	LEVY B. (GBR)
BLOMHERT Daniel	NED	26	BLOMHERT D. (NED)
MAMINSKI Konrad	POL	26	BLOMHERT D. (NED)
YOKOYAMA Yuichi	GER	27	YOKOYAMA Y. (GER)
BENKOV Oleksandr	POL	27	YOKOYAMA Y. (GER)
SVIDRAK Volodymyr	UKR	28	SVIDRAK V. (UKR)
SHERIMBEKOV Amir	KGZ	28	SVIDRAK V. (UKR)
YUSUBOV Abil	AZE	29	YUSUBOV A. (AZE)
DABROWSKI Norbert	POL	30	DABROWSKI N. (POL)
BURMEISTER Luis	GER	30	DABROWSKI N. (POL)
HEFFERNAN Eden	GBR	31	HEFFERNAN E. (GBR)
KURAUJI Iakovos	CYP	31	HEFFERNAN E. (GBR)
BLYZNIUK Tymur	POL	32	BLYZNIUK T. (POL)
VARMUZKA Matej	CZE	32	BLYZNIUK T. (POL)

REPECHAGE

KAZIMIERCZAK A. (POL)	61	DAVIES P. (GBR)	65	TAAVITSAINEN J. (FIN)	69	AKOTO R. (GER)
DAVIES P. (GBR)		TAAVITSAINEN J. (FIN)		AKOTO R. (GER)		
SOBCHENKO M. (POL)	62	VAN DER VEEN Q. (NED)	66	VAN DER VEEN Q. (NED)	70	BULOCINIC T. (ISR)
VAN DER VEEN Q. (NED)		NOACK M. (GER)		BULOCINIC T. (ISR)		
JOVSA D. (LTU)	63	JOVSA D. (LTU)	67	GUENTHER N. (GER)	71	MARLOV A. (SWE)
DABROWSKI N. (POL)	64	GUENTHER N. (GER)		MARLOV A. (SWE)		
		DABROWSKI N. (POL)	68	DABROWSKI N. (POL)	72	LEVY B. (GBR)
		HEFFERNAN E. (GBR)		LEVY B. (GBR)		

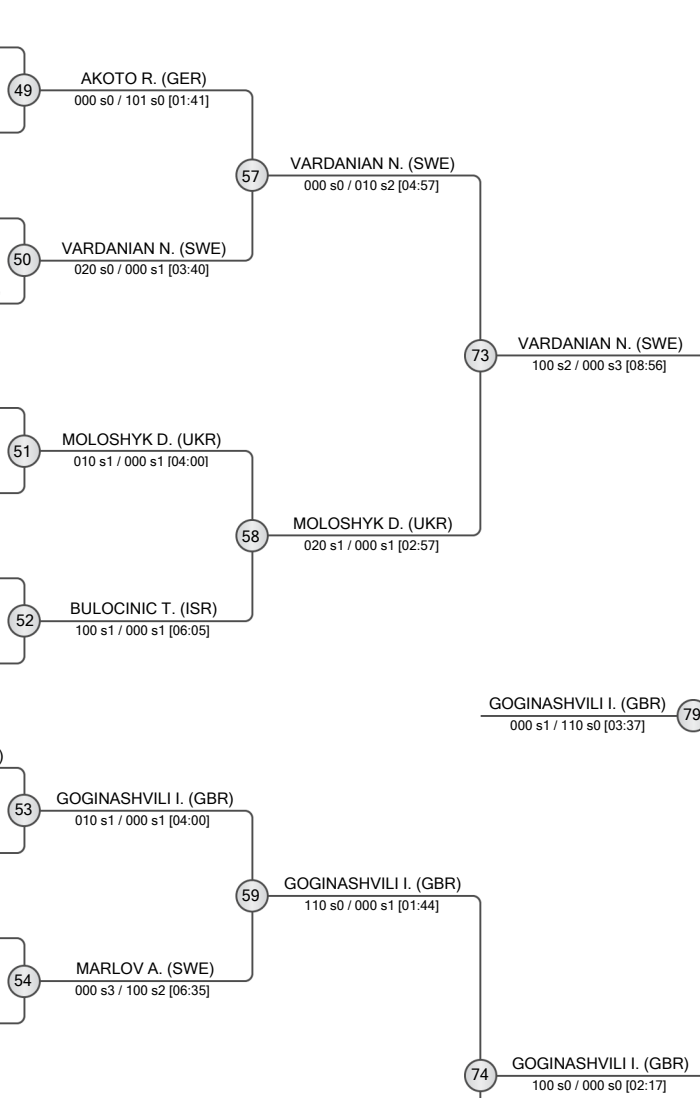

FINAL RESULTS		
1.	GOGINASHVILI Irakli	GBR
2.	VARDANIAN Narek	SWE
3.	YUSUBOV Abil	AZE
5.	AKOTO Raphael	GER
5.	LEVY Benjamin	GBR
7.	BULOCINIC Tom	ISR
7.	MARLOV Alexander	SWE





Poznan Junior European Cup 2025

Poland, Poznan, 5-6 Apr 2025

-81 kg

Men (52)

POOL A

1	SHUKUROV Suleyman (AZE)	1	SHUKUROV S. (AZE)
2	PLOSTNIEKS Ronalds (LAT)	2	PLOSTNIEKS R. (LAT)
3	SAHIR Stanislav (UKR)	3	SAHIR S. (UKR)
4	GLJS Fidder (NED)	4	LALEIKE Yoshiya (GER)
5	LUDZIA Jan Kanty (POL)	5	LALEIKE Y. (GER)
6	DIKAJEV Saad (EST)	6	DIKAJEV S. (EST)
7	PERTELSON Kristofer (FIN)	7	PERTELSON K. (FIN)
8	MASHKO Dzmityry (POL)	8	GROSMAN Y. (ISR)
9	BLIN Matej (CZE)	9	GROSMAN Y. (ISR)
10	GROSMAN Yair (ISR)	10	DAVIES L. (GBR)
11	DAVIES Luke (GBR)	11	DAVIES L. (GBR)

POOL B

9	NIELZIEV Taras (UKR)	9	NIELZIEV T. (UKR)
10	MATTSSON Ville (SWE)	10	HEINEMANN E. (GER)
11	HEINEMANN Erik (GER)	11	MAROUSEK A. (CZE)
12	MAROUSEK Alex (CZE)	12	LEWANDOWSKI Franciszek (POL)
13	LEWANDOWSKI Franciszek (POL)	13	AVDEJEVS Aleksandrs (LAT)
14	AVDEJEVS Aleksandrs (LAT)	14	KAPSOUROUS M. (GRE)
15	KAPSOUROUS Marios (GRE)	15	HULSHOF Q. (NED)
16	HULSHOF Quinn (NED)	16	ZAWADKA Jakub (POL)
17	ZAWADKA Jakub (POL)	17	KOCZINSKI Arel (ISR)
18	KOCZINSKI Arel (ISR)	18	PUSHKAROV Denys (SVK)
19	PUSHKAROV Denys (SVK)	19	KHAMMO Viacheslav (UKR)
20	KHAMMO Viacheslav (UKR)	20	BRZUSZCZYNSKI Szymon (POL)
21	BRZUSZCZYNSKI Szymon (POL)	21	BRZUSZCZYNSKI Szymon (POL)

POOL C

17	TSURKAN Igor (UKR)	17	TSURKAN I. (UKR)
18	DISTEL Konstantin (GER)	18	DISTEL K. (GER)
19	JACENKO Arturs (LAT)	19	ADAMEC Tomas Ignac (CZE)
20	ADAMEC Tomas Ignac (CZE)	20	KRAWCZYK Bartosz (POL)
21	KRAWCZYK Bartosz (POL)	21	VAN RIEL Stan (NED)
22	VAN RIEL Stan (NED)	22	NEUMANN Eryk (GBR)
23	NEUMANN Eryk (GBR)	23	PARKHOMENKO Maksym (UKR)
24	PARKHOMENKO Maksym (UKR)	24	FRIDMAN ZILBERSTEIN Reem (ISR)
25	FRIDMAN ZILBERSTEIN Reem (ISR)	25	RACKA Norbertas (LTU)
26	RACKA Norbertas (LTU)	26	ANARBEKOV Arsen (KGZ)
27	ANARBEKOV Arsen (KGZ)	27	IBADLI Jasur (AZE)
28	IBADLI Jasur (AZE)	28	IBADLI Jasur (AZE)
29	IBADLI Jasur (AZE)	29	SWIDWA Robert (POL)
30	SWIDWA Robert (POL)	30	SWIDWA Robert (POL)

POOL D

25	TARKOWSKI Fabrycjusz (POL)	25	TARKOWSKI F. (POL)
26	KRAAK Pepijn (NED)	26	GORUN V. (UKR)
27	GORUN Volodymyr (UKR)	27	YOSUL C. (GER)
28	YOSUL Can Ilias (GER)	28	KUCERA Kristian (CZE)
29	KUCERA Kristian (CZE)	29	BALAMPANIDIS Iraklis (GRE)
30	BALAMPANIDIS Iraklis (GRE)	30	BALAMPANIDIS I. (GRE)
31	AGRONOV Yaniv (ISR)	31	AGRONOV Y. (ISR)
32	MOYLETT Antony (GBR)	32	MOYLETT A. (GBR)
33	LUDZIA Franciszek (POL)	33	SZULIK Szymon (POL)
34	SZULIK Szymon (POL)	34	BUJUKLIEV Alex (SWE)
35	BUJUKLIEV Alex (SWE)	35	PYSHNIAK Bohdan (UKR)
36	PYSHNIAK Bohdan (UKR)	36	MOZGO Dautartas (LTU)
37	MOZGO Dautartas (LTU)	37	MOZGO Dautartas (LTU)

REPECHAGE

61	PLOSTNIEKS R. (LAT)	61	PLOSTNIEKS R. (LAT)
62	MAROUSEK A. (CZE)	62	MAROUSEK A. (CZE)
63	PARKHOMENKO M. (UKR)	63	NEUMANN E. (GBR)
64	NEUMANN E. (GBR)	64	GORUN V. (UKR)
65	SAHIR S. (UKR)	65	SAHIR S. (UKR)
66	MAROUSEK A. (CZE)	66	NIELZIEV T. (UKR)
67	NEUMANN E. (GBR)	67	IBADLI J. (AZE)
68	GORUN V. (UKR)	68	BALAMPANIDIS I. (GRE)
69	PLOSTNIEKS R. (LAT)	69	PLOSTNIEKS R. (LAT)
70	KOCZINSKI A. (ISR)	70	KOCZINSKI A. (ISR)
71	IBADLI J. (AZE)	71	DISTEL K. (GER)
72	BALAMPANIDIS I. (GRE)	72	BALAMPANIDIS I. (GRE)
73	SHUKUROV S. (AZE)	73	SHUKUROV S. (AZE)
74	TARKOWSKI F. (POL)	74	TARKOWSKI F. (POL)
75	KOCZINSKI A. (ISR)	75	KOCZINSKI A. (ISR)
76	IBADLI J. (AZE)	76	IBADLI J. (AZE)
77	FRIDMAN ZILBERSTEIN R. (ISR)	77	FRIDMAN ZILBERSTEIN R. (ISR)
78	AVDEJEVS A. (LAT)	78	AVDEJEVS A. (LAT)
79	TARKOWSKI F. (POL)	79	TARKOWSKI F. (POL)

FINAL RESULTS		
1.	TARKOWSKI Fabrycjusz	POL
2.	SHUKUROV Suleyman	AZE
3.	FRIDMAN ZILBERSTEIN Reem	ISR
4.	AVDEJEVS Aleksandrs	LAT
5.	KOCZINSKI Arel	ISR
6.	IBADLI Jasur	AZE
7.	PLOSTNIEKS Ronalds	LAT
8.	BALAMPANIDIS Iraklis	GRE





Poznan Junior European Cup 2025

Poland, Poznan, 5-6 Apr 2025

-90 kg
Men (36)

POOL A

SHAMIL Tuncay	AZE	1	SHAMIL T. (AZE)
RONIS Alexander	ISR	2	RONIS A. (ISR)
OLEKSY Mateusz	POL	3	OLEKSY M. (POL)
KHOROSHAILOV Mykhailo	UKR	4	KHOROSHAILOV M. (UKR)
SPYRYDONOV Daniil	GER	5	SPYRYDONOV D. (GER)
SIERAKOWSKI Mateusz	POL	6	SIERAKOWSKI M. (POL)
FOUKAL Ondrej	CZE	7	PARSHYN V. (UKR)
PARSHYN Viacheslav	UKR	8	PARSHYN V. (UKR)
KURACH Dominik	POL		KURACH D. (POL)

POOL B

LAUFMANIS Ernests	LAT	9	LAUFMANIS E. (LAT)
TOMASZKIEWICZ Justus	POL	10	TOMASZKIEWICZ J. (POL)
LASZCZOK Nikodem	POL	11	LASZCZOK N. (POL)
NEDERBRAGT Bram	NED	12	NEDERBRAGT B. (NED)
HICKEY Cameron	GBR	13	HICKEY C. (GBR)
RUDI Lennox	GER	14	RUDI L. (GER)
SOKYRKO Serhii	UKR	15	SOKYRKO S. (UKR)
JAKS Adam	CZE	16	JAKS A. (CZE)
BOGDANSKI Wojciech	POL		BOGDANSKI W. (POL)

POOL C

PACARIZ Armin	GER	17	PACARIZ A. (GER)
SOKOLOWSKI Konrad	POL	18	SOKOLOWSKI K. (POL)
MANFELDS Tomass	LAT	19	MANFELDS T. (LAT)
KRAUSS Jan	POL	20	KRAUSS J. (POL)
GAZIMAMMADOV Ali	AZE	21	GAZIMAMMADOV A. (AZE)
BAALMANS Nils	NED	22	BAALMANS N. (NED)
HARMASH Ivan	UKR	23	HARMASH I. (UKR)
KOZLOWSKI Maciej	POL	24	KOZLOWSKI M. (POL)
BRESLER Yonatan	ISR		BRESLER Y. (ISR)

POOL D

MARCZAK Derek	POL	25	MARCZAK D. (POL)
KIRK Joseph	GBR	26	KIRK J. (GBR)
WILLSCH Justin	GER	27	WILLSCH J. (GER)
POTUCEK Tomas	CZE	28	POTUCEK T. (CZE)
GRZESKOWIAK Adam	POL	29	GRZESKOWIAK A. (POL)
BRAZANI Gal	ISR	30	BRAZANI G. (ISR)
YAKHNIN Georgy	GER	31	YAKHNIN G. (GER)
TOKHTAMYSH Oleksandr	UKR	32	TOKHTAMYSH O. (UKR)
PASZEK Damian	POL		PASZEK D. (POL)

REPECHAGE

RONIS A. (ISR)	61	RONIS A. (ISR)	65	RONIS A. (ISR)	69	SPYRYDONOV D. (GER)
JAKS A. (CZE)		KHOROSHAILOV M. (UKR)		SPYRYDONOV D. (GER)		
BOGDANSKI W. (POL)	62	BOGDANSKI W. (POL)	66	HICKEY C. (GBR)	70	NEDERBRAGT B. (NED)
		HICKEY C. (GBR)		NEDERBRAGT B. (NED)		
KOZLOWSKI M. (POL)	63	KOZLOWSKI M. (POL)	67	BAALMANS N. (NED)	71	PACARIZ A. (GER)
		BAALMANS N. (NED)		PACARIZ A. (GER)		
KIRK J. (GBR)	64	KIRK J. (GBR)	68	KIRK J. (GBR)	72	BRAZANI G. (ISR)
		POTUCEK T. (CZE)		BRAZANI G. (ISR)		

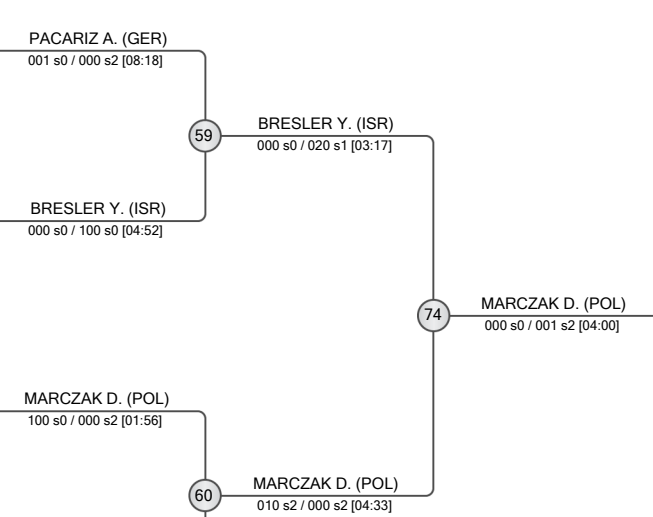
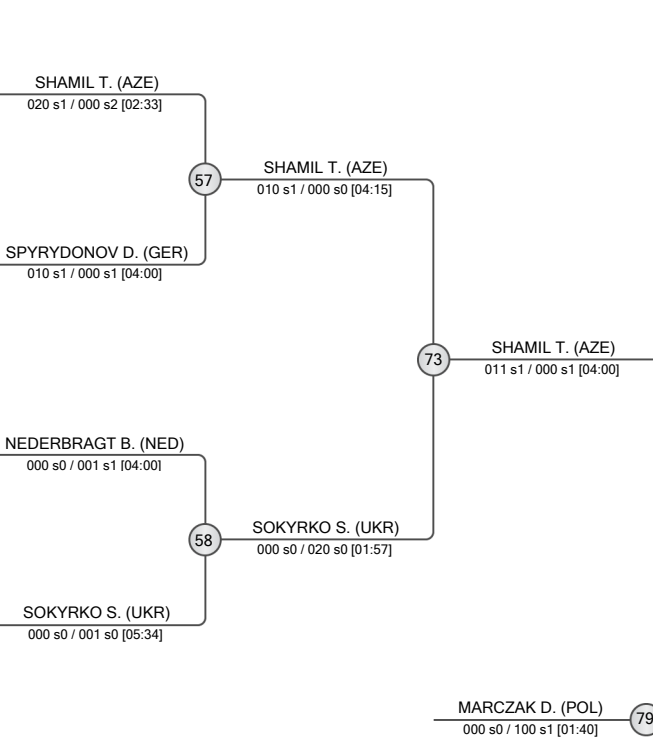

FINAL RESULTS	
1. MARCZAK Derek	POL
2. SHAMIL Tuncay	AZE
3. NEDERBRAGT Bram	NED
3. SOKYRKO Serhii	UKR
5. BRESLER Yonatan	ISR
5. BRAZANI Gal	ISR
7. SPYRYDONOV Daniil	GER
7. PACARIZ Armin	GER





Poznan Junior European Cup 2025

Poland, Poznan, 5-6 Apr 2025

-100 kg
Men (23)

POOL A

	KUBIAK Damian	POL
	HROMYKO Nikita	UKR
	BUTIJER Borna	CRO
	UZAN Amit Amos	ISR
	DUIKER Redmer	NED

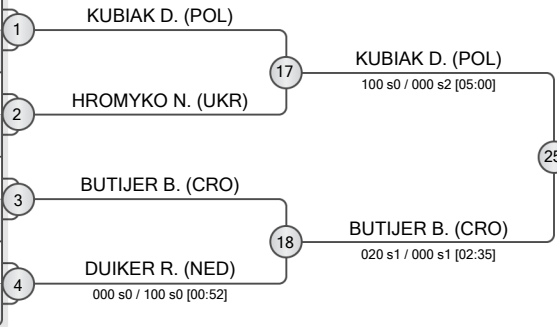

POOL B

	SCHEFFEL Oliver	SVK
	SZYMAINSKI Paul	GER
	WACKO Mateusz	POL
	SPERLIDIS Alexios	GRE
	CECH Vaclav	CZE
	MARCIN Walenciak	POL

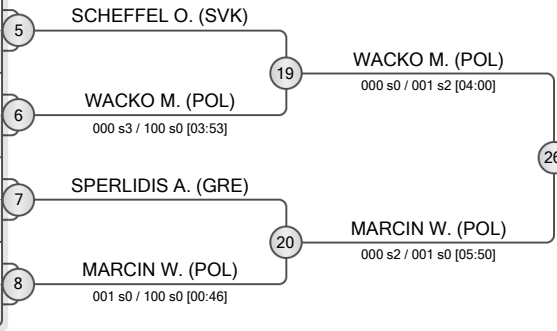

POOL C

	WALENCIAK Michal	POL
	SCHINDLER Lasse Tjark	GER
	KAGAN BARNEA Lotam	ISR
	FRANSENS Leonhard	NED
	MAHAMEED Vincent	POL
	LEBID Dmytro	UKR

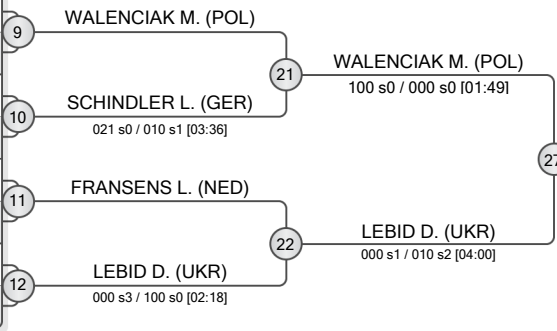

POOL D

	YUDANOV Nikita	UKR
	TESMAR Mateusz	POL
	SCHWEIGER Bill	GER
	BIZANS Maksims	LAT
	NAMAZLI Davud	AZE
	JERABEK Martin	CZE

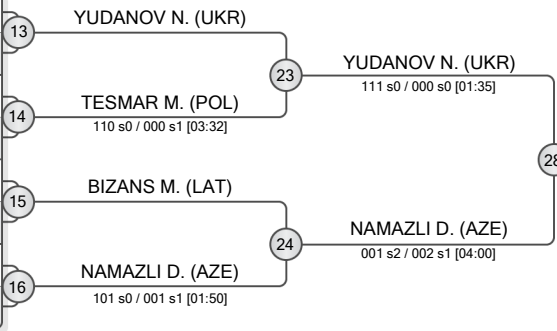

REPECHAGE

DUIKER R. (NED)	329	DUIKER R. (NED)	333
CECH V. (CZE)		KUBIAK D. (POL)	
SPERLIDIS A. (GRE)	330	SPERLIDIS A. (GRE)	334
		WACKO M. (POL)	
SCHINDLER L. (GER)	331	SCHINDLER L. (GER)	335
		LEBID D. (UKR)	
TESMAR M. (POL)	332	TESMAR M. (POL)	336
		NAMAZLI D. (AZE)	

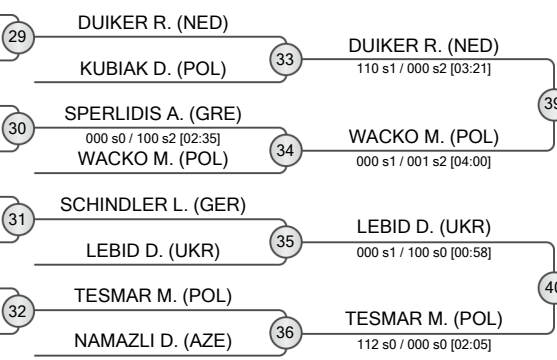

FINAL RESULTS	
1.	YUDANOV Nikita
2.	BUTIJER Borna
3.	WACKO Mateusz
3.	MARCIN Walenciak
5.	WALENCIAK Michal
5.	TESMAR Mateusz
7.	DUIKER Redmer
7.	LEBID Dmytro





Poznan Junior European Cup 2025

Poland, Poznan, 5-6 Apr 2025

+100 kg

Men (15)

POOL A

	SUHA Mortaza	GER
	DOBRIAN Marcel	POL
	FESENKO Oleh	UKR

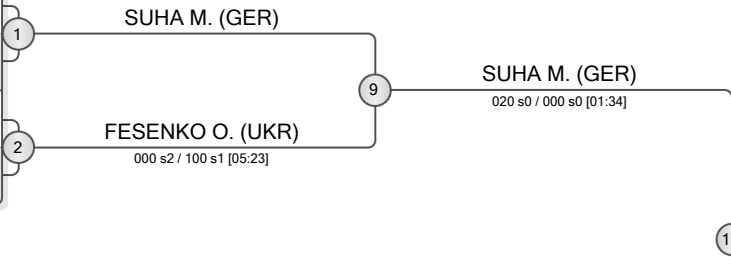

POOL B

	YAROSHENKO Fedir	UKR
	WILHELM Christian	GER
	MASAK Marek-Adrian	EST
	ALIYEV Eldar	AZE

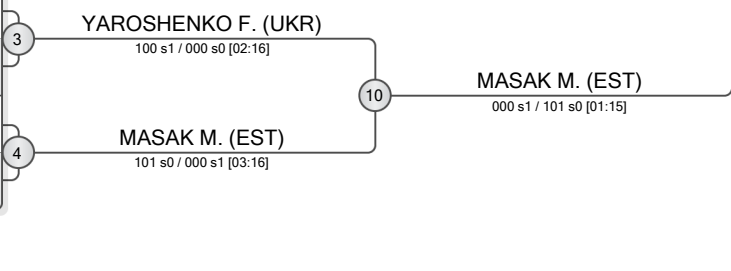

POOL C

	OMELCHENKO Yaroslav	UKR
	DAMM Felix	GER
	SEDLAK Martin	CZE
	KHACHATRYAN Anton	POL

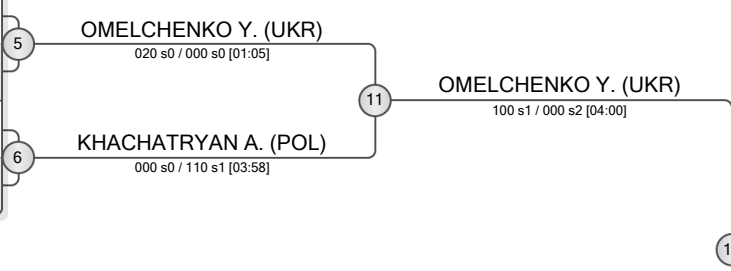

POOL D

	AHMADOV Ramazan	AZE
	BALLERING Martinus	NED
	CHAMERSKI Daniel	POL
	KULCHYTSKYI Denys	UKR

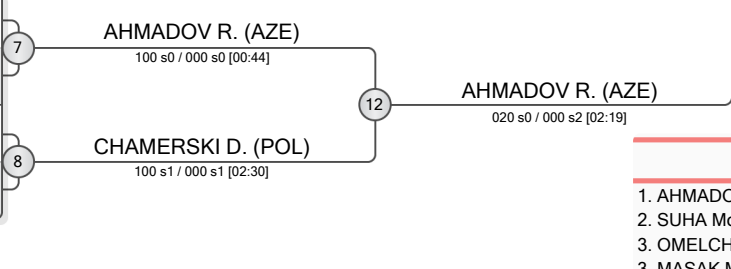

FINAL RESULTS		
1.	AHMADOV Ramazan	AZE
2.	SUHA Mortaza	GER
3.	OMELCHENKO Yaroslav	UKR
3.	MASAK Marek-Adrian	EST
5.	FESENKO Oleh	UKR
5.	BALLERING Martinus	NED
7.	ALIYEV Eldar	AZE
7.	KHACHATRYAN Anton	POL

REPECHAGE

13	FESENKO O. (UKR)
14	ALIYEV E. (AZE)
15	YAROSHENKO F. (UKR)
16	DAMM F. (GER)
17	KHACHATRYAN A. (POL)
18	BALLERING M. (NED)
19	CHAMERSKI D. (POL)

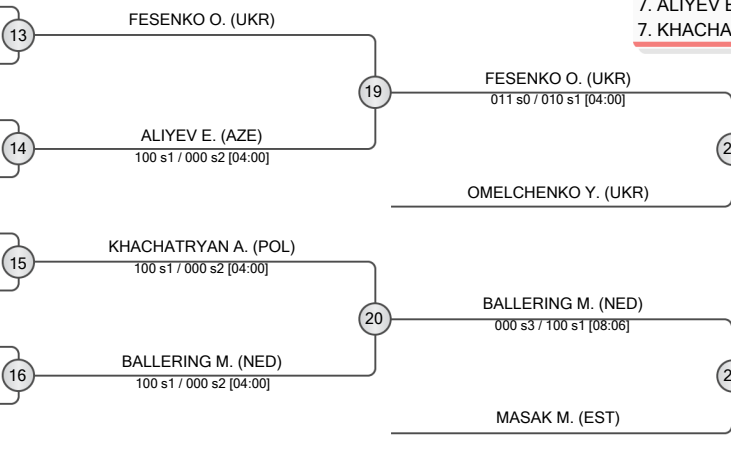



Poznan Junior European Cup 2025

Poland, Poznan, 5-6 Apr 2025

-48 kg

Women (15)

POOL A

	HABIB Helen	GER
	GHAFFAR Asal	GER
	POTOK Nina	POL

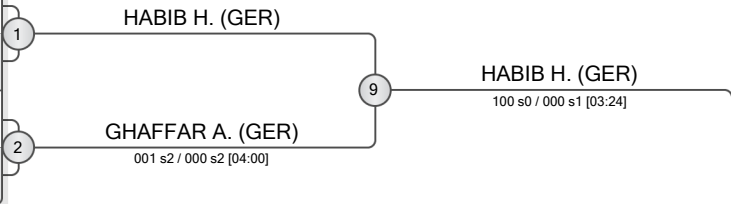

POOL B

	HOEKSTRA Robin	NED
	CZERWINSKA-KOWAR Roksana	POL
	TWAROWSKA Barbara	POL
	WARNERS Megan	NED

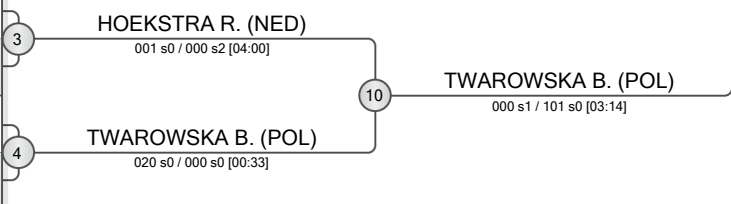

POOL C

	TOMANKOVA Patricia	SVK
	ZGLICZYNSKA Alicja	POL
	STOFBERG Lara	NED
	KABELKOVA Karolina	CZE

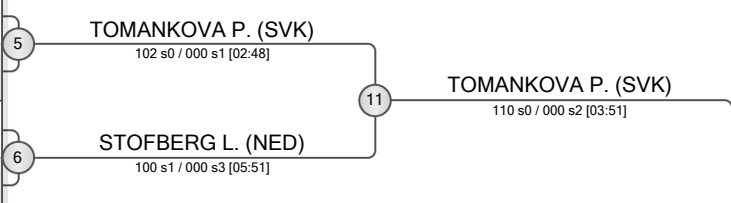

POOL D

	RIKMANSPOEL Maud	NED
	MUTAEVA Sofija	POL
	KOZUCH Oliwia	POL
	BULGA Nicola	GBR

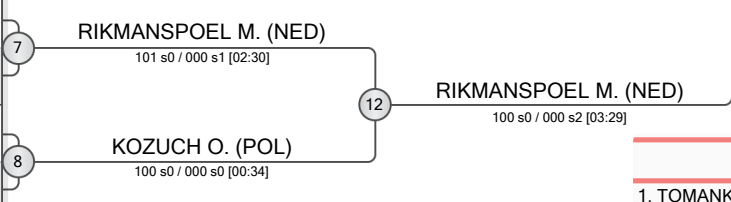

REPECHAGE

GHAFFAR A. (GER)	13
WARNERS M. (NED)	14
HOEKSTRA R. (NED)	14
ZGLICZYNSKA A. (POL)	15
STOFBERG L. (NED)	15
MUTAEVA S. (POL)	16
KOZUCH O. (POL)	16

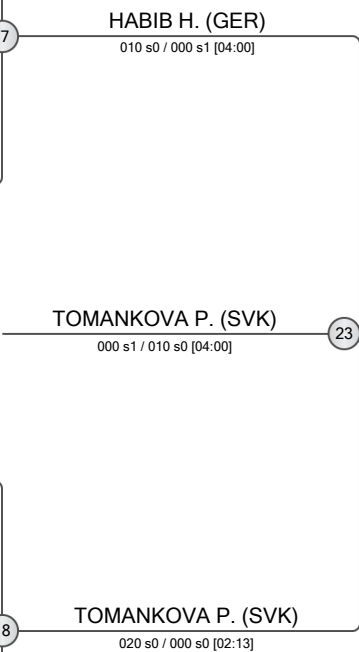
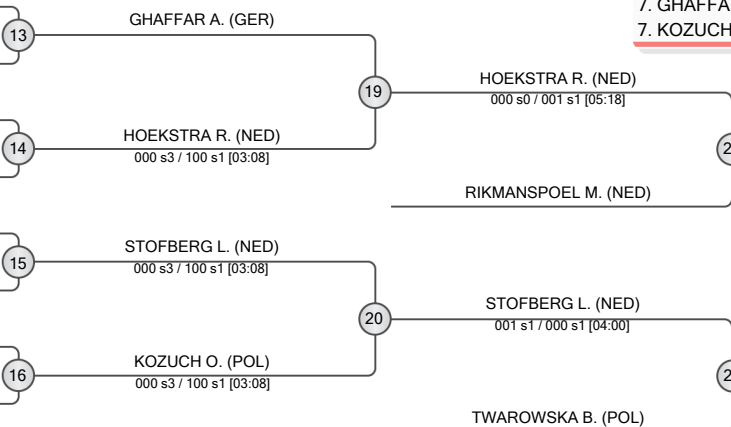

FINAL RESULTS		
1.	TOMANKOVA Patricia	SVK
2.	HABIB Helen	GER
3.	RIKMANSPOEL Maud	NED
3.	TWAROWSKA Barbara	POL
5.	HOEKSTRA Robin	NED
5.	STOFBERG Lara	NED
7.	GHAFFAR Asal	GER
7.	KOZUCH Oliwia	POL





Poznan Junior European Cup 2025

Poland, Poznan, 5-6 Apr 2025

-52 kg
Women (23)

POOL A

	MECKLENBURG Tabea Nika	GER
	PERRA Arianna Carlotta	ITA
	KYRYLIUK Tetiana	POL
	KISSENISKY Maddy	GBR
	JESIONEK Maria	POL
	HARDENBERG Janine	GER

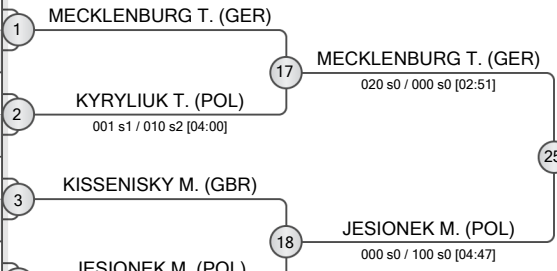

POOL B

	HODSON Lola	GBR
	NETTESHEIM Charlotte	GER
	JAKOBCZYK Maria	POL
	VAN LEEUWEN Emma	NED
	BUSAUSKAITE Migle	LTU
	ROZENBAUM Magdalena	POL

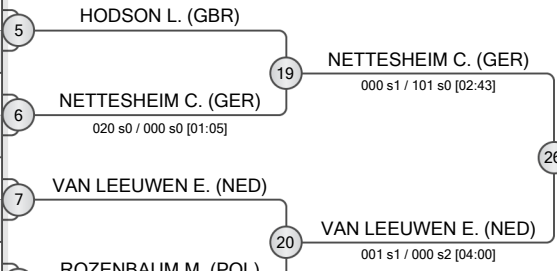

POOL C

	WANDEL Vera	NED
	GOGUA Maria Eleni	GRE
	GALEK Martyna	POL
	SLAZOK Wiktoria	POL
	ERTEN Klara	GER
	CHRISTODOULIDOU Adamantia	CYP

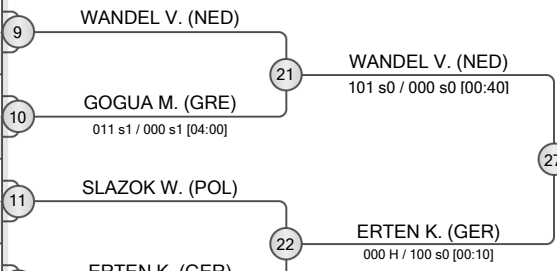

POOL D

	GUETH Nina	GER
	NOWOSAD Roza	POL
	LUIS Shanice	NED
	GRZESZCZYK Otylia	POL
	KORCAKOVA Marketa	CZE

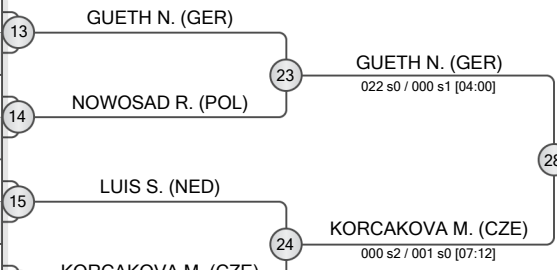

FINAL RESULTS	
1.	MECKLENBURG Tabea Nika GER
2.	ERTEN Klara GER
3.	HODSON Lola GBR
3.	WANDEL Vera NED
5.	GUETH Nina GER
7.	JESIONEK Maria POL
7.	KORCAKOVA Marketa CZE

REPECHAGE

KYRYLIUK T. (POL) 29	KYRYLIUK T. (POL)	33	JESIONEK M. (POL)
JAKOBCZYK M. (POL) 30	HODSON L. (GBR)	34	HODSON L. (GBR)
HODSON L. (GBR)	VAN LEEUWEN E. (NED)	35	WANDEL V. (NED)
CHRISTODOULIDOU A. (CYP) 31	CHRISTODOULIDOU A. (CYP)	36	KORCAKOVA M. (CZE)
SLAZOK W. (POL)	WANDEL V. (NED)		
NOWOSAD R. (POL) 32	NOWOSAD R. (POL)		
NOWOSAD R. (POL)	KORCAKOVA M. (CZE)		

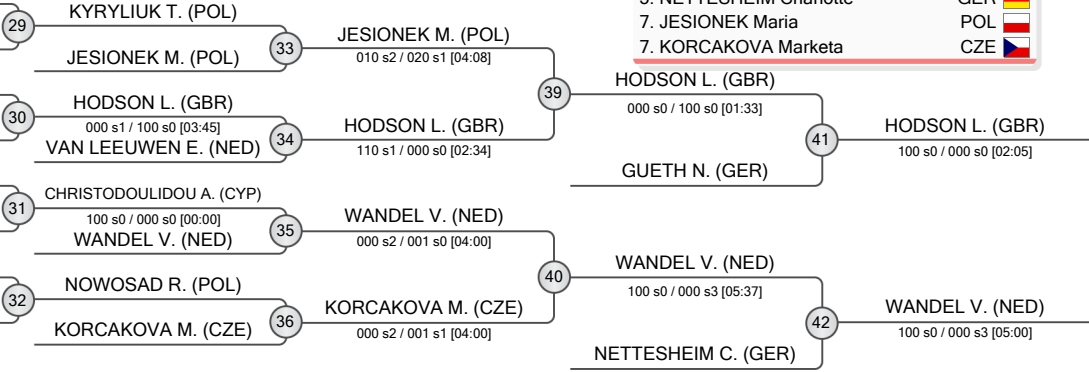



Poznan Junior European Cup 2025

Poland, Poznan, 5-6 Apr 2025

-57 kg
Women (25)

POOL A

	CHMIELEWSKA Kinga	POL
	BANNISTER Callie	AUS
	RICHTER Miu	GER
	KOLAKOWSKA Zuzanna	POL
	NOUFAL Noor	NED
	CZUPKOWSKA Liwia	POL
	KRAUSE Kathrin	GER

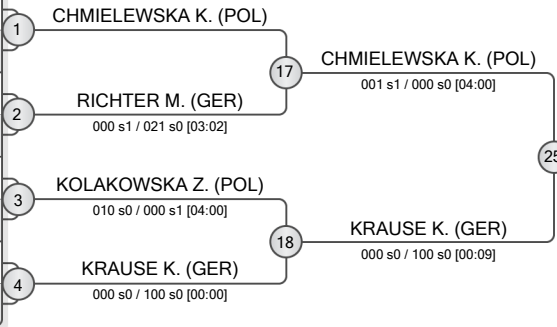

POOL B

	BULANDA Julia	POL
	COLBERS Marlouk	NED
	HALCINOVA Eliska	SVK
	JENMAN Charlotte	GBR
	KOSTER Skadi	GER
	JANUSZ Urszula	POL

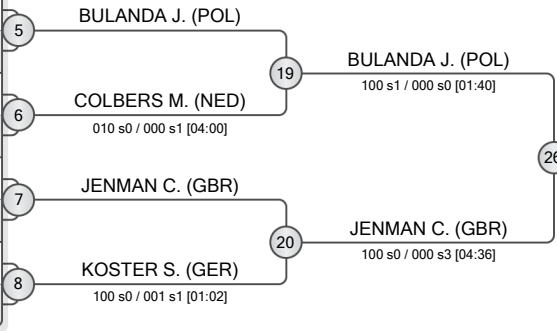

POOL C

	BIRRI Madeleine	GBR
	WICKERT Leonie	GER
	ZOZULINSKA Kalina	POL
	HENSEN Faye	NED
	CAPEZZUTO Martina	ITA
	WALEGA Magdalena	POL

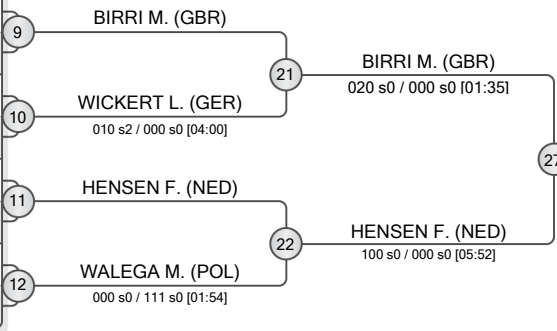

POOL D

	LINK Chloe	GBR
	PATANE Maya	GER
	ZELEK Zuzanna	POL
	RIEGERT Helene	GER
	RUSTIGE Elise	NED
	SZOPA Martyna	POL

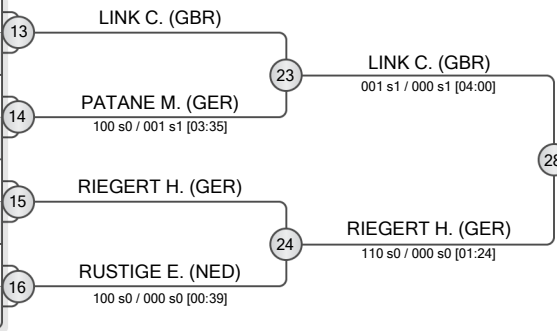

REPECHAGE

RICHTER M. (GER)	29	RICHTER M. (GER)	33
KOSTER S. (GER)	30	BULANDA J. (POL)	34
WALEGA M. (POL)	31	BIRRI M. (GBR)	35
RUSTIGE E. (NED)	32	LINK C. (GBR)	36

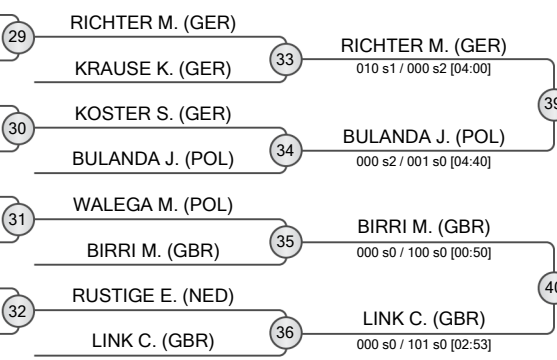

FINAL RESULTS	
1.	RIEGERT Helene GER
2.	CHMIELEWSKA Kinga POL
3.	BULANDA Julia POL
3.	LINK Chloe GBR
5.	HENSEN Faye NED
7.	JENMAN Charlotte GBR
7.	RICHTER Miu GER
7.	BIRRI Madeleine GBR





Poznan Junior European Cup 2025

Poland, Poznan, 5-6 Apr 2025

-63 kg
Women (27)

POOL A

	TOMANKOVA Lenka	SVK
	ZABLOCKA Krystyna	POL
	MUELLER Katharina	GER
	SIRINIDOU Galini	GRE
	PTASINSKA Amelia	POL
	CECHOVA Veronika	CZE
	SCHWARZENBERG Julia	GER

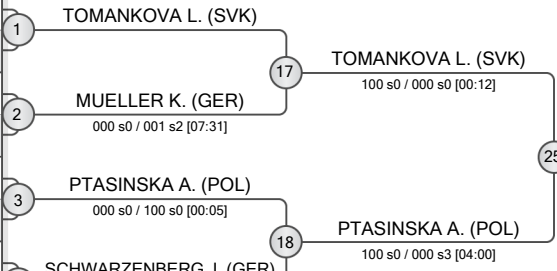

POOL B

	HANGYI Eva	NED
	ECKMANN Greta	GER
	GAZECKA Pola	POL
	DELAHUNTY Olivia	GBR
	TATAJ Julia	POL
	NOERSKOV Mai	DEN

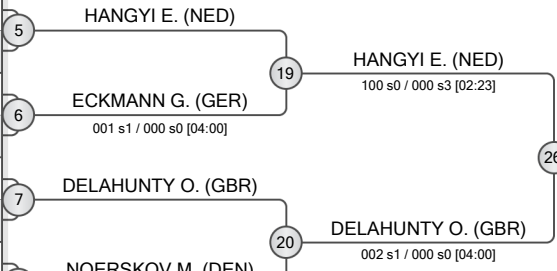

POOL C

	HOGARTH Estela	AUS
	SEMOUD Luna	GER
	WOZNICZKO Nadia	POL
	KUCHAR Varvara	LTU
	KUZMINSKA Oliwia	POL
	OFFENBERG Leah	NED
	AUMANN Felizitas	GER

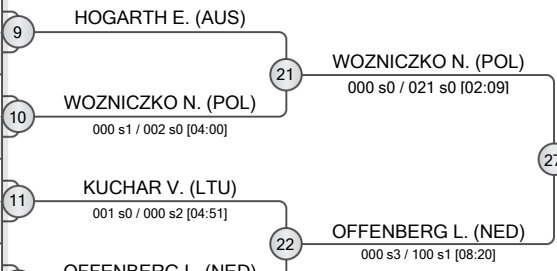

POOL D

	GARLAND Marley	GER
	WOZNIAK Urszula	POL
	VASILIOU Sofia	CYP
	BAGNIEWSKA Amelia	POL
	STEINEBRUNNER Salome	GER
	SIENICKA Antonina	POL
	DRDAKOVA Martina	SVK

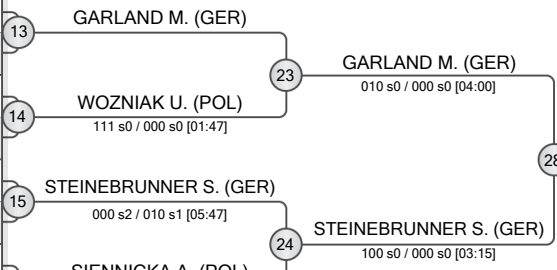

FINAL RESULTS	
1.	WOZNICZKO Nadia (POL)
2.	TOMANKOVA Lenka (SVK)
3.	PTASINSKA Amelia (POL)
3.	STEINEBRUNNER Salome (GER)
5.	GARLAND Marley (GER)
7.	DELAHUNTY Olivia (GBR)
7.	SEMOUD Luna (GER)

REPECHAGE

MUELLER K. (GER)	29	MUELLER K. (GER)	33	PTASINSKA A. (POL)
ECKMANN G. (GER)	30	DELAHUNTY O. (GBR)	34	DELAHUNTY O. (GBR)
SEMOUD L. (GER)	31	SEMOUD L. (GER)	35	SEMOUD L. (GER)
HOGARTH E. (AUS)	31	OFFENBERG L. (NED)	35	SEMOUD L. (GER)
WOZNIAK U. (POL)	32	WOZNIAK U. (POL)	36	STEINEBRUNNER S. (GER)
WOZNIAK U. (POL)	32	STEINEBRUNNER S. (GER)	36	STEINEBRUNNER S. (GER)

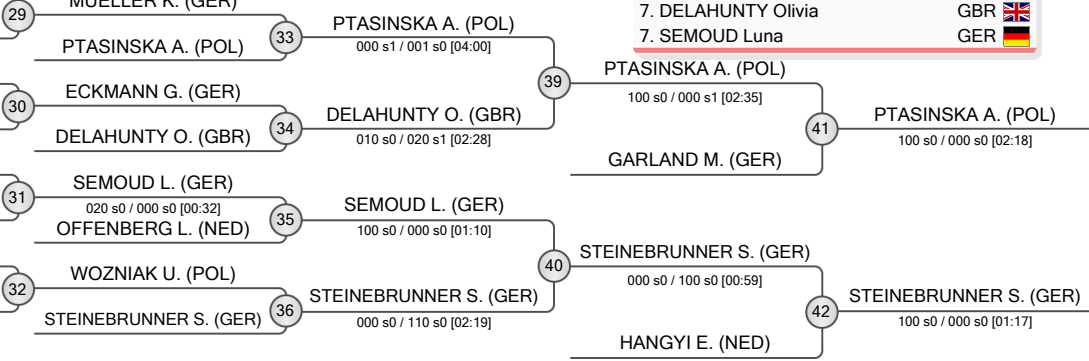



Poznan Junior European Cup 2025

Poland, Poznan, 5-6 Apr 2025

-70 kg

Women (33)

POOL A

1	PAPAGIANNAKI Alexandra (GRE)	PAPAGIANNAKI A. (GRE)
2	SCHIPPER Yael (NED)	SCHIPPER Y. (NED) 33
3	MUELLER Hannah (GER)	MUELLER H. (GER)
4	PIECHNA Olga (POL)	PIECHNA O. (POL) 34
5	POGOSYAN Gayane (EST)	POGOSYAN G. (EST)
6	WITKOWSKA Wiktoria (POL)	WITKOWSKA W. (POL) 35
7	SKORUPINSKA Martyna (POL)	SKORUPINSKA M. (POL)
8	BAUR Coco-Mia (GER)	BAUR C. (GER) 36

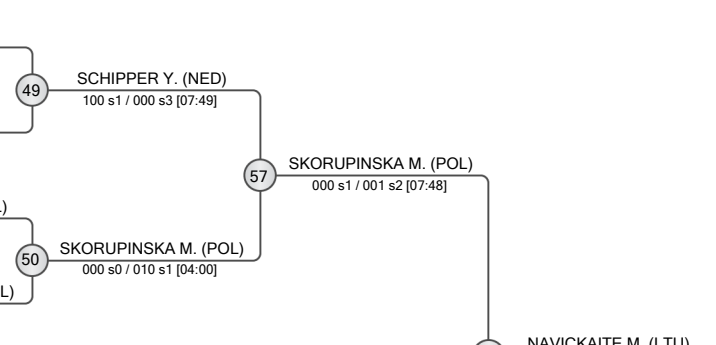

POOL B

9	GLUBIAK Magda (POL)	GLUBIAK M. (POL)
10	THIELE Alica (GER)	THIELE A. (GER) 37
11	BENKOVA Diana (POL)	BENKOVA D. (POL)
12	DE KOCK Luna (NED)	DE KOCK L. (NED) 38
13	NAVICKAITE Marta (LTU)	NAVICKAITE M. (LTU)
14	NEMCOVA Barbora (CZE)	NEMCOVA B. (CZE) 39
15	PIETRZAK Gabriela (POL)	MICIC U. (BIH) 40
16	MICIC Una (BIH)	NEUMANN M. (GER) 40
16	NEUMANN Malin (GER)	NEUMANN M. (GER) 40

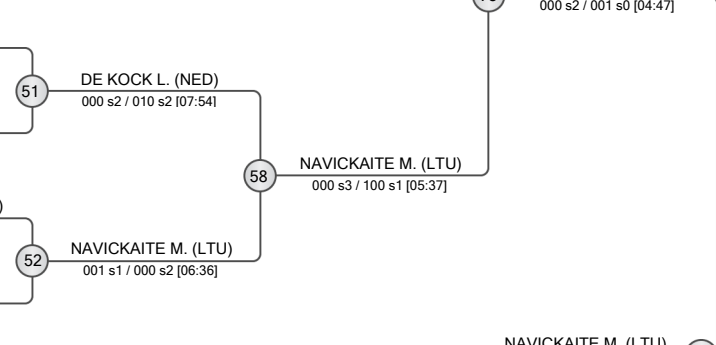

POOL C

17	MARCZAK Julia (POL)	MARCZAK J. (POL)
18	JONGSTRA Anmar (NED)	JONGSTRA A. (NED) 41
19	WINTER Leya (GER)	WINTER L. (GER)
20	SCHENK Magdalena (POL)	SCHENK M. (POL) 42
21	XANTHOPOULOU Sofia (GRE)	XANTHOPOULOU S. (GRE)
22	KNAFELC Noeli (SLO)	KNAFELC N. (SLO) 43
23	ZYS Roksana (POL)	ZYS R. (POL)
24	KONRAD Sveyarike (GER)	KONRAD S. (GER) 44

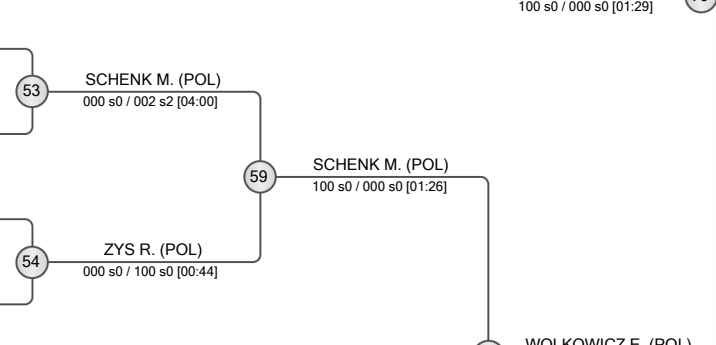

POOL D

25	VERDONK Aloha (NED)	VERDONK A. (NED)
26	PRESTIN Jara (GER)	PRESTIN J. (GER) 45
27	KORDEL Vilja (SWE)	KORDEL V. (SWE)
28	WOLKOWICZ Emilia (POL)	WOLKOWICZ E. (POL) 46
29	LISTL Emma (GER)	LISTL E. (GER)
30	OLSZEWSKA Kinga (POL)	OLSZEWSKA K. (POL) 47
31	SIMUNKOVA Adela (CZE)	SIMUNKOVA A. (CZE)
32	JONGSTRA Luca (NED)	JONGSTRA L. (NED) 48

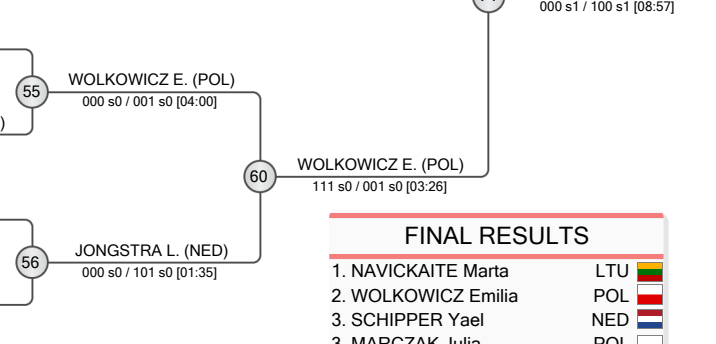

FINAL RESULTS

1.	NAVICKAITE Marta	LTU
2.	WOLKOWICZ Emilia	POL
3.	SCHIPPER Yael	NED
3.	MARCZAK Julia	POL
5.	SCHENK Magdalena	POL
5.	SKORUPINSKA Martyna	POL
7.	NEMCOVA Barbora	CZE
7.	VERDONK Aloha	NED

REPECHAGE

61	BAUR C. (GER)	BAUR C. (GER)
62	NEMCOVA B. (CZE)	NEMCOVA B. (CZE) 66
63	WINTER L. (GER)	WINTER L. (GER)
64	KORDEL V. (SWE)	KORDEL V. (SWE)
65	WITKOWSKA W. (POL)	WITKOWSKA W. (POL) 65
66	NEUMANN M. (GER)	NEUMANN M. (GER) 66
67	MARCZAK J. (POL)	MARCZAK J. (POL) 67
68	VERDONK A. (NED)	VERDONK A. (NED) 68
69	SCHIPPER Y. (NED)	SCHIPPER Y. (NED) 69
70	DE KOCK L. (NED)	DE KOCK L. (NED) 70
71	ZYS R. (POL)	ZYS R. (POL) 71
72	JONGSTRA L. (NED)	JONGSTRA L. (NED) 72

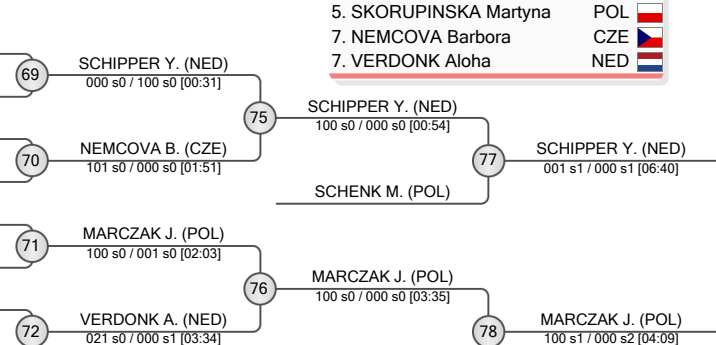



Poznan Junior European Cup 2025

Poland, Poznan, 5-6 Apr 2025

-78 kg

Women (11)

POOL A

	HANSTED E Maria	NED
	WIDLAK Nicole	POL
	MANUKYAN Mia	GER

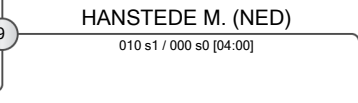
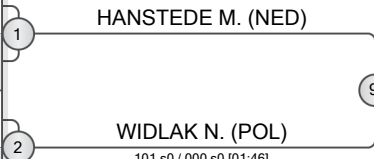

POOL B

	WOOD Nicole	GBR
	HOJDAROVA Stepanka	CZE

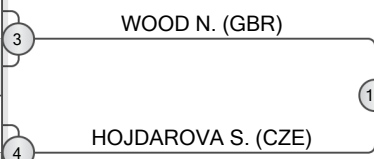

POOL C

	PAJIC Sofija	BIH
	HARTMEIJER Lindy	NED
	PIKOSZ Nicole	POL

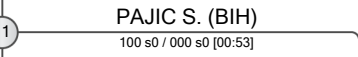
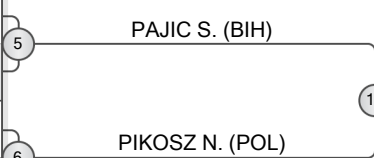

POOL D

	HASSAN Anya	GBR
	SCHREIBER Zyna	GER
	VAN LIJF Xanne	NED

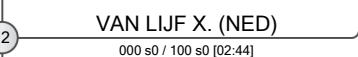
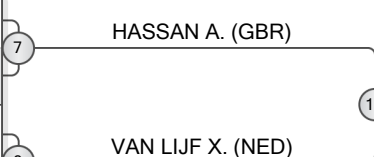

REPECHAGE

13	WIDLAK N. (POL)
14	WOOD N. (GBR)
15	PIKOSZ N. (POL)
16	SCHREIBER Z. (GER)
16	HASSAN A. (GBR)

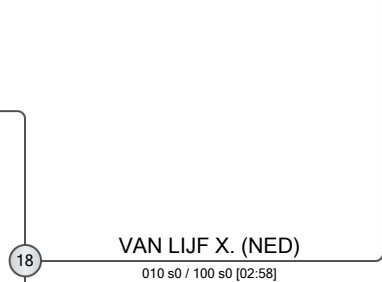
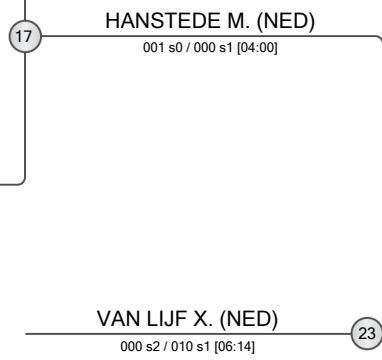
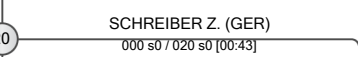
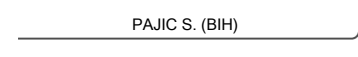
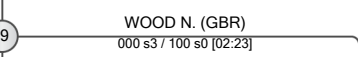
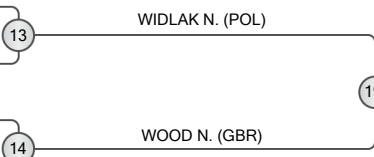

FINAL RESULTS		
1.	VAN LIJF Xanne	NED
2.	HANSTED E Maria	NED
3.	PAJIC Sofija	BIH
3.	HOJDAROVA Stepanka	CZE
5.	WOOD Nicole	GBR
5.	SCHREIBER Zyna	GER
7.	WIDLAK Nicole	POL
7.	PIKOSZ Nicole	POL





Poznan Junior European Cup 2025

Poland, Poznan, 5-6 Apr 2025

+ 78 kg

Women (6)

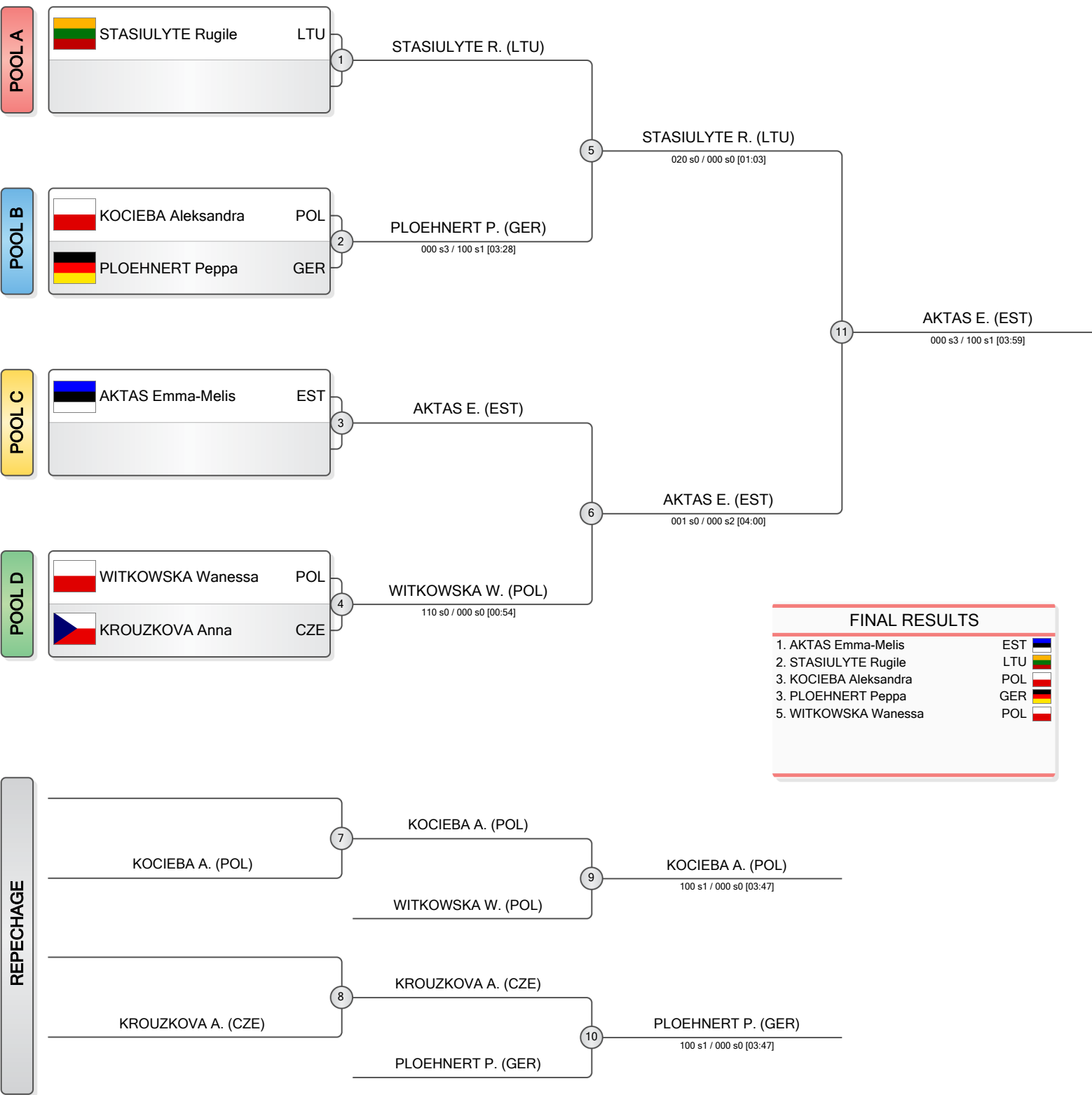

FINAL RESULTS	
1. AKTAS Emma-Melis	EST
2. STASIULYTE Rugile	LTU
3. KOCIEBA Aleksandra	POL
3. PLOEHNERT Peppa	GER
5. WITKOWSKA Wanessa	POL

