



Porec Millennium Team Cadet European Cup 2025

Croatia, Porec, 15-16 Mar 2025

-50 kg

Men (40)

POOL A

	SZABO Milan	HUN	1	SZABO M. (HUN)
	SHREBERK Guy	ISR	2	SHREBERK G. (ISR)
	LEGER VILLA Lucien	FRA	3	ADUASHVILI L. (GEO)
	ADUASHVILI Lasha	GEO	3	ADUASHVILI L. (GEO)
	BIOSCA GARCIA Renat	ESP	4	BIOSCA GARCIA R. (ESP)
	SHEMESH Shachar	ISR	5	SHEMESH S. (ISR)
	CARP Maxim	MDA	6	CARP M. (MDA)
	ARIANO Mattia	ITA	7	ARIANO M. (ITA)
	LOZO Marin	CRO	7	ARIANO M. (ITA)
	AVRAMOVIC Boban	SRB	8	AVRAMOVIC B. (SRB)

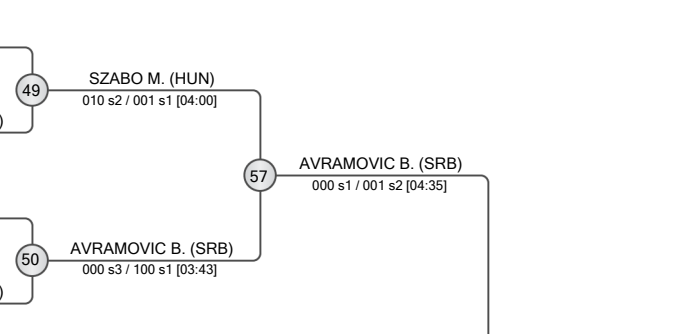

POOL B

	CHIARELLA Luca	ITA	9	CHIARELLA L. (ITA)
	ANDJELOVIC Ilija	SRB	10	ANDJELOVIC I. (SRB)
	COLAK Ismail	AUT	11	MOR BARAK O. (ISR)
	MOR BARAK Omer	ISR	11	MOR BARAK O. (ISR)
	STETS Kiril	UKR	12	STETS K. (UKR)
	DOBROWOLSKI Bartlomiej	POL	13	DOBROWOLSKI B. (POL)
	SOLDO Marin	CRO	14	LEMOs RODRIGUEZ O. (ESP)
	LEMOs RODRIGUEZ Omar	ESP	14	LEMOs RODRIGUEZ O. (ESP)
	CHANSSEAUME Lucas	FRA	15	CHANSSEAUME L. (FRA)
	PALCO Daniel	SVK	16	PALCO D. (SVK)

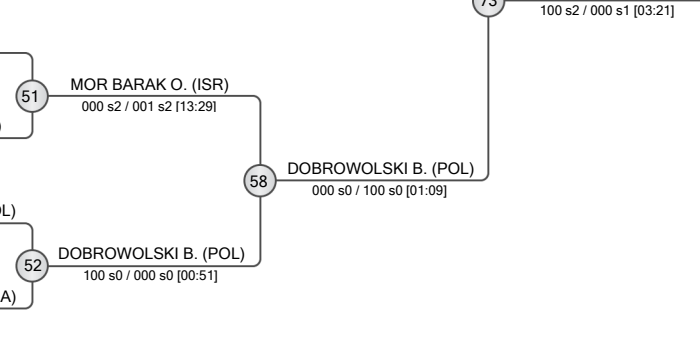

POOL C

	PENEZ Enzo	FRA	17	PENEZ E. (FRA)
	TANZI Eros	ITA	18	TANZI E. (ITA)
	BERMAN Shayan	ISR	19	BERMAN S. (ISR)
	LASICA Andrej	CRO	19	BERMAN S. (ISR)
	VLAD Sorin	ROU	20	VLAD S. (ROU)
	DUFRAIGNE Mathis	FRA	21	DUFRAIGNE M. (FRA)
	SERAFINI Samuel	ITA	22	SERAFINI S. (ITA)
	MARCHIORI Ugo	LUX	23	BOGDANOVIC L. (SRB)
	BOGDANOVIC Lazar	SRB	23	BOGDANOVIC L. (SRB)
	PRADO MORENO Izan	ESP	24	PRADO MORENO I. (ESP)

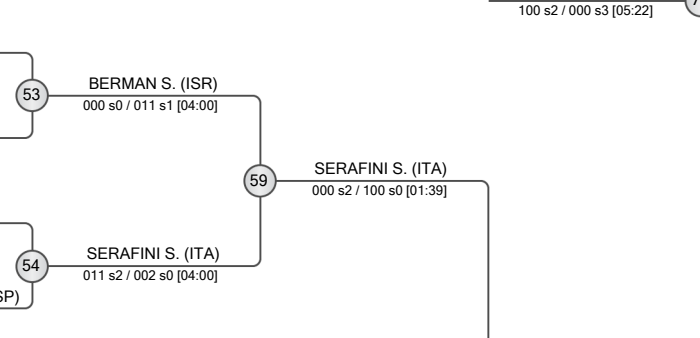

POOL D

	GILBERT Coen	GBR	25	GILBERT C. (GBR)
	CHRISTOFF Ruben	SUI	26	CHRISTOFF R. (SUI)
	RIELLO Nino	FRA	27	RIELLO N. (FRA)
	FEDOR Bence	HUN	27	RIELLO N. (FRA)
	GESUELE Emanuele	ITA	28	GESUELE E. (ITA)
	CHIARRONI CUTILLAS Alejandro	ESP	29	CHIARRONI CUTILLAS A. (ESP)
	TRUBKOVYCH Nikita	UKR	30	TRUBKOVYCH N. (UKR)
	GART Lidor	ISR	31	GART L. (ISR)
	ZELLER Gabriel	LIE	31	GART L. (ISR)
	TOLIC Roko	CRO	32	TOLIC R. (CRO)

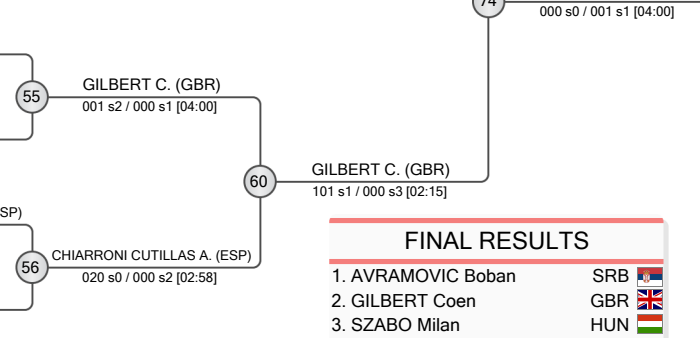

FINAL RESULTS

- AVRAMOVIC Boban
- GILBERT Coen
- SZABO Milan
- CHIARRONI CUTILLAS Alejandro
- SERAFINI Samuel
- DOBROWOLSKI Bartlomiej
- CHANSSEAUME Lucas
- PRADO MORENO Izan

REPECHAGE

ARIANO M. (ITA)	61	ARIANO M. (ITA)	65	SHEMESH S. (ISR)	69	SZABO M. (HUN)
LEMOs RODRIGUEZ O. (ESP)	62	LEMOs RODRIGUEZ O. (ESP)	66	CHANSSEAUME L. (FRA)	70	CHANSSEAUME L. (FRA)
DUFRAIGNE M. (FRA)	63	DUFRAIGNE M. (FRA)	67	PRADO MORENO I. (ESP)	71	PRADO MORENO I. (ESP)
CHRISTOFF R. (SUI)	64	CHRISTOFF R. (SUI)	68	CHRISTOFF R. (SUI)	72	CHIARRONI CUTILLAS A. (ESP)

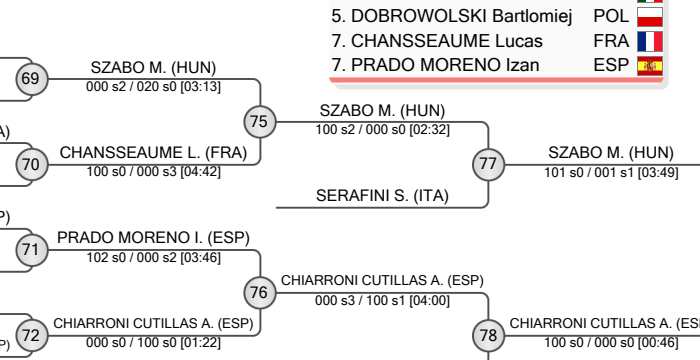



Porec Millennium Team Cadet European Cup 2025

Croatia, Porec, 15-16 Mar 2025

-55 kg

Men (64)

POOL A

1	JAKUBAUSKAS Adris (LTU)	110 s1 / 000 s0 [01:20]	33	JAKUBAUSKAS A. (LTU)	111 s2 / 000 s0 [01:44]	
2	ZVORC Jona (CRO)	100 s0 / 000 s1 [02:17]		49	JAKUBAUSKAS A. (LTU)	101 s0 / 000 s1 [03:25]
3	ROLNIK Gali (ISR)	000 s1 / 021 s0 [01:50]	34	MALIC N. (MDA)	100 s0 / 000 s0 [01:01]	
4	VAKIL Christoph (AUT)	100 s2 / 000 s3 [06:12]		57	JAKUBAUSKAS A. (LTU)	101 s0 / 000 s2 [03:43]
5	BEN LULU Jonathan (ISR)	102 s0 / 000 s1 [04:00]	35	SORICI A. (ROU)	001 s2 / 000 s2 [04:00]	
6	MALIC Nelu (MDA)	000 s0 / 100 s0 [01:31]		50	SORICI A. (ROU)	100 s0 / 000 s3 [03:09]
7	GAVRILOVIC Mateja (SRB)	000 s1 / 001 s1 [04:23]	36	BULINGER D. (GER)	100 s2 / 000 H [04:00]	
8	BERARDI Yuri (ITA)	000 s0 / 101 s0 [00:47]				

POOL B

9	CORI Silvano (SUI)	110 s0 / 000 s0 [00:20]	37	CORI S. (SUI)	021 s0 / 010 s0 [03:03]	
10	DAMM Oliver (HUN)	110 s0 / 000 s3 [02:49]		51	CORI S. (SUI)	100 s0 / 000 s0 [01:17]
11	DERNONCOURT Matthias (FRA)	002 s1 / 000 s1 [04:00]	38	SANDRINI A. (ITA)	000 s2 / 001 s0 [04:00]	
12	WINKLER Inbar (ISR)	101 s0 / 000 s0 [01:18]		52	GUALANDI M. (ITA)	100 s0 / 000 s0 [01:13]
13	TATARYN Nikita (UKR)	111 s0 / 000 s0 [03:03]	39	GUALANDI M. (ITA)	020 s0 / 000 s0 [01:00]	
14	DANGUBIC Luka (SRB)	000 s0 / 110 s0 [01:48]		40	POLO LAGUNA M. (ESP)	100 s2 / 000 s1 [05:11]
15	SANDRINI Angelo Karol (ITA)	001 s0 / 010 s1 [04:00]				
16	CUKROV Adam (CRO)	001 s0 / 010 s1 [04:00]				

POOL C

17	BUTUCI Kristian (CRO)	100 s0 / 000 s0 [00:42]	41	BUTUCI K. (CRO)	021 s0 / 000 s1 [02:41]	
18	KEYSER Thibault (FRA)	110 s0 / 000 H [00:22]		53	HONTIUK R. (UKR)	000 s1 / 001 s2 [04:00]
19	PIPAN Tim (SLO)	000 s0 / 101 s0 [00:24]	42	HONTIUK R. (UKR)	101 s0 / 000 s3 [03:31]	
20	TOREN Noam (ISR)	010 s0 / 022 s0 [03:41]		54	DUBROVSKY T. (ISR)	000 s0 / 101 s0 [00:48]
21	MINUTILLO Alessio (ITA)	000 s1 / 001 s2 [04:00]	43	SCHUMANN J. (GER)	012 s0 / 100 s1 [03:52]	
22	HONTIUK Roman (UKR)	001 s0 / 110 s0 [03:32]		55	DUBROVSKY T. (ISR)	110 s1 / 001 s0 [02:08]
23	DANGUBIC Vuk (SRB)	000 s0 / 101 s0 [01:49]	44	DUBROVSKY T. (ISR)	110 s1 / 001 s0 [02:08]	
24	LEITERT Csongor (HUN)	101 s0 / 000 s0 [01:03]				

POOL D

25	MALDONADO Esteban (ARG)	100 s2 / 000 s3 [03:33]	45	MALDONADO E. (ARG)	001 s1 / 000 s2 [04:25]	
26	GOLDMAN Gilad (ISR)	000 s1 / 021 s0 [03:13]		55	MALDONADO E. (ARG)	110 s0 / 010 s3 [08:35]
27	MOROSAN Andrei (MDA)	000 s0 / 102 s0 [03:12]	46	BOULEMTAFES S. (FRA)	020 s1 / 000 s0 [01:18]	
28	PARLATI Marco (ITA)	000 s0 / 111 s0 [00:55]		56	ZINCHUK M. (UKR)	020 s0 / 000 s0 [00:17]
29	MARKOVIC Petar (SRB)	000 s0 / 111 s0 [00:55]	47	ZINCHUK M. (UKR)	102 s0 / 000 s1 [02:11]	
30	BOULEMTAFES Shain (FRA)	024 s0 / 001 s2 [03:32]		57	BLACKSHAW R. (GBR)	000 s0 / 100 s0 [00:39]
31	MISKOVIC HASANBEGOVIC Noa (CRO)	110 s0 / 000 H [02:54]	48	BLACKSHAW R. (GBR)	000 s0 / 100 s0 [00:39]	
32	RON Guy (ISR)	000 s0 / 101 s0 [01:50]				

REPECHAGE

61	ZVORC J. (CRO)	001 s0 / 000 s0 [04:00]	65	MALIC N. (MDA)	000 s0 / 100 s0 [00:15]	
62	ROLNIK G. (ISR)	010 s2 / 003 s1 [04:00]		69	SORICI A. (ROU)	000 s3 / 100 s0 [04:49]
63	DAMM O. (HUN)	000 s1 / 100 s0 [03:54]	66	SANDRINI A. (ITA)	000 s0 / 101 s0 [00:49]	
64	DERNONCOURT M. (FRA)	001 s1 / 000 s1 [04:00]		70	GUALANDI M. (ITA)	000 s2 / 010 s0 [04:00]
65	RUCINSKI-ZAJAC A. (POL)	000 s0 / 110 s0 [01:40]	67	SCHUMANN J. (GER)	000 s0 / 100 s0 [02:12]	
66	GHIDONI T. (ITA)	000 s0 / 100 s0 [02:12]		71	HONTIUK R. (UKR)	001 s2 / 010 s1 [04:00]
67	GOLDMAN G. (ISR)	000 s1 / 100 s0 [02:47]	68	BOULEMTAFES S. (FRA)	000 s1 / 101 s0 [02:47]	
68	PARLATI M. (ITA)	000 s0 / 100 s0 [00:10]		72	ZINCHUK M. (UKR)	000 s0 / 100 s0 [00:10]

FINAL RESULTS

- DUBROVSKY Tom (ISR)
- CORI Silvano (SUI)
- GUALANDI Matteo (ITA)
- ZINCHUK Maksym (UKR)
- MALDONADO Esteban (ARG)
- JAKUBAUSKAS Adris (LTU)
- SORICI Alin Marian (ROU)
- HONTIUK Roman (UKR)





Porec Millennium Team Cadet European Cup 2025

Croatia, Porec, 15-16 Mar 2025

-60 kg

Men (93)

POOL A

	MUNIZ ACOSTA Jakub	POL	1	MUNIZ ACOSTA J. (POL)
	WEINBERGER Omri	ISR	2	GULASHVILI S. (GEO)
	GULASHVILI Shaiva	GEO		000 s2 / 100 s1 [04:15]
	DI GIANNI Federico	ITA	3	DI GIANNI F. (ITA)
	SCHRODL Kornel	HUN	4	SCHRODL K. (HUN)
	MARTZIANO Eyal	ISR	5	UHREKHELIDZE D. (UKR)
	UHREKHELIDZE Davyd	UKR		000 s1 / 102 s0 [03:45]
	MILLIGAN Jack	GBR	6	MILLIGAN J. (GBR)
	WINTER Felix	GER	7	WINTER F. (GER)
	PELEGRIN Tom	FRA		100 s0 / 001 s0 [02:20]
	MAGURA Danilo	SRB	8	MAGURA D. (SRB)
	KUNYIK Botond	HUN	9	KUNYIK B. (HUN)
	SCHWANINGER Levin	SUI	10	RIVERO SANTAMARIA A. (ESP)
	RIVERO SANTAMARIA Aitor	ESP		000 s1 / 011 s0 [04:00]
	OHRENSTEIN Yehonatan	ISR	11	OHRENSTEIN Y. (ISR)
	SABLJO Ivano	CRO		021 s0 / 000 s0 [01:31]
	COOK Lochlan	AUS	12	COOK L. (AUS)
	KEZUNOVIC Luka	BIH	13	RICHTER L. (SLO)
	RICHTER Liam	SLO		000 s0 / 100 s0 [00:00]
	TAKHAEV Mukhamed	GER	14	TAKHAEV M. (GER)
	BARNATAN Ori	ISR	15	BARNATAN O. (ISR)
	BOSCH Paul	AUT		020 s0 / 000 s1 [04:00]
	KAPANADZE Giorgi	GEO	16	KAPANADZE G. (GEO)

POOL B

	FEDORA Ferenc	HUN	17	FEDORA F. (HUN)
	JOVANOVIC Luka	SRB	18	SEMENOVYCH R. (UKR)
	SEMENOVYCH Rostyslav	UKR		001 s0 / 020 s0 [02:50]
	MONTES OLIVA Lucas	ESP	19	COHEN E. (ISR)
	COHEN Elon	ISR		000 s2 / 010 s0 [04:23]
	GEGIA Giorgi	GEO	20	GEGIA G. (GEO)
	HANISCH Quentin	GER	21	CORI T. (SUI)
	CORI Timeo	SUI		000 s1 / 020 s0 [01:22]
	AMALBERT Marius	FRA	22	AMALBERT M. (FRA)
	MILLER Yonathan	ISR	23	MILLER Y. (ISR)
	ABASOV Abdumalik	AUT		110 s2 / 000 s0 [03:01]
	BRISUDA Filip	SVK	24	BRISUDA F. (SVK)
	CRUCES Lautaro	ARG	25	CRUCES L. (ARG)
	MULYK Denys	UKR	26	MULYK D. (UKR)
	PIPAN Nik	SLO		100 s0 / 000 s0 [02:04]
	GRUBER Maximilian Koh	GER	27	GRUBER M. (GER)
	CELJAK Erik	CRO		110 s0 / 000 s0 [00:18]
	SIMON Tege	ROU	28	SIMON T. (ROU)
	TEMIRBAEV Amir	CAN	29	TEMIRBAEV A. (CAN)
	PANCZEL Csanad	HUN		100 s1 / 000 s1 [03:18]
	CELOTTO Domenico	ITA	30	CELOTTO D. (ITA)
	VAN TIJN Itay	ISR	31	TCHINTCHARAULI S. (GEO)
	TCHINTCHARAULI Sandro	GEO		002 s1 / 010 s1 [04:00]
	MILOSEVIC Aleksa	SRB	32	MILOSEVIC A. (SRB)

REPECHAGE

BARNATAN O. (ISR)	125	BARNATAN O. (ISR)	129	TAKHAEV M. (GER)	133	KUNYIK B. (HUN)
SEMENOVYCH R. (UKR)	126	SEMENOVYCH R. (UKR)	130	GEGIA G. (GEO)	134	GEGIA G. (GEO)
GREENBERG O. (ISR)	127	GREENBERG O. (ISR)	131	TANG S. (GBR)	135	RADANOV N. (SRB)
GLASER J. (GER)	128	GLASER J. (GER)	132	TAMAS G. (ROU)	136	GLASER J. (GER)

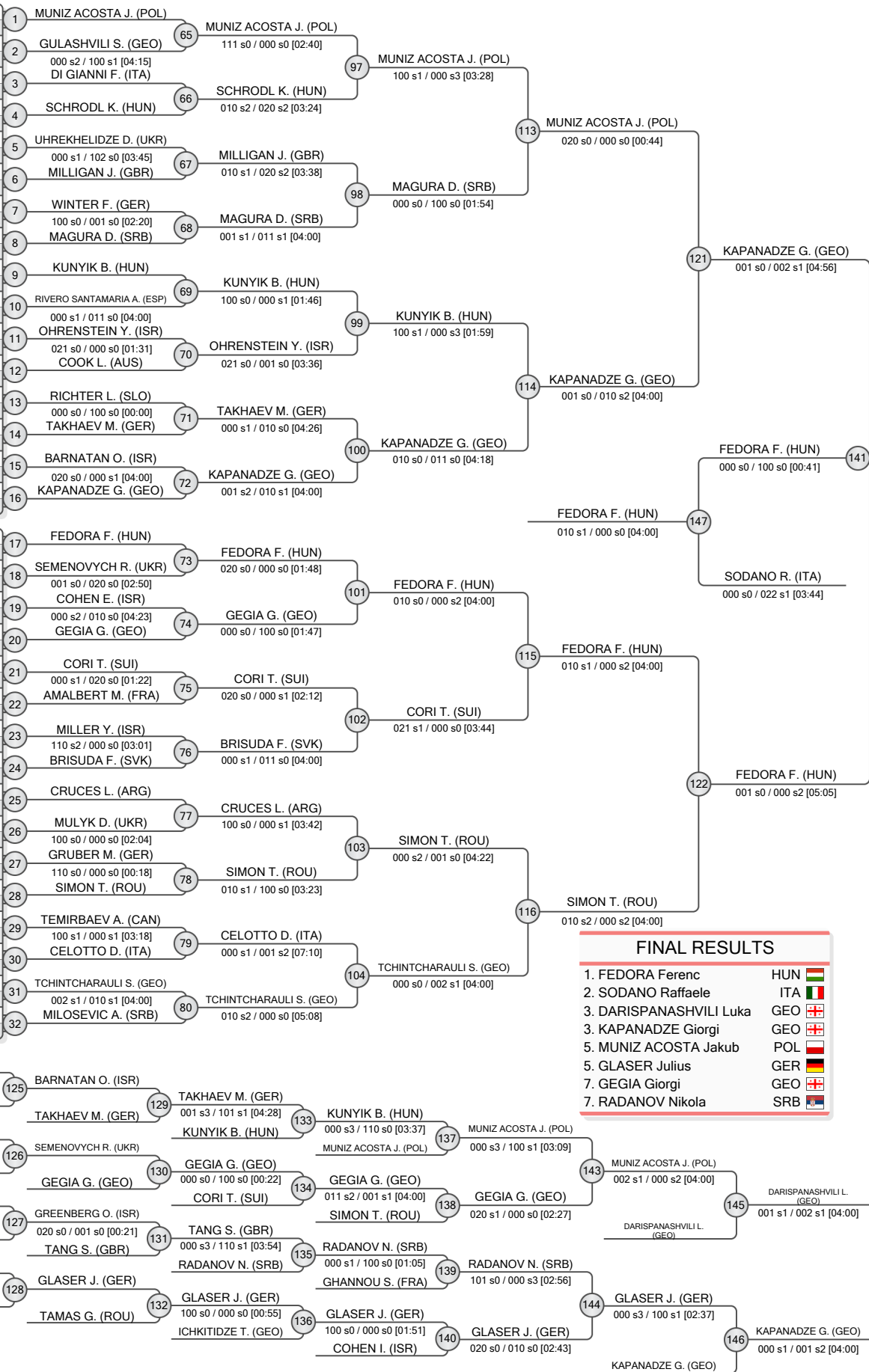

FINAL RESULTS		
1.	FEDORA Ferenc	HUN
2.	SODANO Raffaele	ITA
3.	DARISPANASHVILI Luka	GEO
3.	KAPANADZE Giorgi	GEO
5.	MUNIZ ACOSTA Jakub	POL
5.	GLASER Julius	GER
7.	GEGIA Giorgi	GEO
7.	RADANOV Nikola	SRB





Porec Millennium Team Cadet European Cup 2025

Croatia, Porec, 15-16 Mar 2025

-60 kg

Men (93)

POOL C

AUS	33	POGREB M. (AUS)	81	BUSURASHVILI G. (GEO)	000 s1 / 100 s0 [01:58]	
SUI	34	G.JORGIEV Ivan Matej		BUSURASHVILI G. (GEO)	001 s0 / 100 s0 [02:36]	
GEO		BUSURASHVILI Goga		105	BUSURASHVILI G. (GEO)	010 s1 / 000 s1 [04:00]
GER	35	ATAMANIUK Rostyslav		82	YAACOBI L. (ISR)	000 s0 / 100 s0 [02:11]
POL		MICHALAK Wojciech		82	YAACOBI L. (ISR)	001 s1 / 002 s2 [04:00]
ISR	36	YAACOBI Liav				
UKR	37	BASOV Renat		83	GHANNOU S. (FRA)	010 s2 / 100 s2 [03:37]
ITA		CARABOTTO Gabriele				
FRA	38	CARABOTTO Sofiane		106	GHANNOU S. (FRA)	100 s0 / 000 s1 [02:08]
SRB	39	MACKIC Luka		84	MACKIC L. (SRB)	010 s1 / 000 s0 [04:00]
ISR	40	GROSS Ido				
SRB	41	RADANOV Nikola		85	RADANOV N. (SRB)	100 s1 / 000 s3 [07:35]
GER	42	FRICK Lennox				
ISR		FRIDMAN Maor		107	RADANOV N. (SRB)	100 s1 / 000 s0 [02:01]
ESP	43	MARTIN TORRES Carlos		86	MARTIN TORRES C. (ESP)	100 s0 / 000 s0 [02:48]
SLO		UNUK Matevz				
HUN	44	SZEGNER Daniel				
GBR	45	TANG Samuel		87	TANG S. (GBR)	100 s0 / 000 s0 [00:13]
MNE		MERULIC Alan				
CRO	46	LUCIC Luka		108	DARISPANASHVILI L. (GEO)	000 s1 / 021 s1 [03:46]
ISR	47	GREENBERG Omer		88	MIJIC M. (AUT)	100 s0 / 000 s0 [01:03]
GEO		DARISPANASHVILI Luka				
AUT	48	MIJIC Matija				

POOL D

ITA	49	SODANO Raffaele		89	SODANO R. (ITA)	011 s1 / 010 s0 [04:00]
ISR		GOGRITCHIANI Nikolozi				
GER	50	GLASER Julius		90	TAMAS G. (ROU)	101 s0 / 000 s0 [02:18]
HUN		MILDNER Nimrod				
ROU	51	TAMAS Gabor				
CRO	52	BARAC Marko				
AUT	53	MILJKOVIC Lazar		91	MILJKOVIC L. (AUT)	100 s0 / 000 s3 [05:03]
AUS		PEAKE Crosby				
ISR	54	SHMUELI Yehonatan		92	ICHKITIDZE T. (GEO)	020 s0 / 000 s0 [01:34]
SLO		NOVAK Nal				
GEO	55	ICHKITIDZE Tsotne				
SRB	56	PETRONIC Konstantin				
UKR	57	HEYDAROV Khazar		93	GOMEZ ANTONA J. (ESP)	000 s1 / 010 s2 [04:33]
GER		DIETZ Julian				
ESP	58	GOMEZ ANTONA Javier		94	COHEN I. (ISR)	000 s2 / 100 s0 [03:22]
SUI		KUBLI Daniel				
CRO	59	GRLJAC Vito				
ISR	60	COHEN Itamar				
CAN	61	TURAJEV Muhammad		95	SHTAIN T. (ISR)	000 s1 / 110 s0 [03:26]
GEO		KAIBULASHVILI Daviti				
ISR	62	SHTAIN Tomer				
KOS	63	GASHI Milot		96	GASHI M. (KOS)	001 s2 / 000 s2 [04:00]
HUN	64	KORONCZAY Kornel				

REPECHAGE

125	BARNATAN O. (ISR)	129	TAKHAEV M. (GER)	133	KUNYIK B. (HUN)	137	MUNIZ ACOSTA J. (POL)
126	SEMEVOYCH R. (UKR)	130	GEGIA G. (GEO)	134	GEGIA G. (GEO)	138	GEGIA G. (GEO)
127	GREENBERG O. (ISR)	131	TANG S. (GBR)	135	RADANOV N. (SRB)	139	RADANOV N. (SRB)
128	GLASER J. (GER)	132	GLASER J. (GER)	136	GLASER J. (GER)	140	GLASER J. (GER)
125	BARNATAN O. (ISR)	129	TAKHAEV M. (GER)	133	KUNYIK B. (HUN)	137	MUNIZ ACOSTA J. (POL)
126	SEMEVOYCH R. (UKR)	130	GEGIA G. (GEO)	134	GEGIA G. (GEO)	138	GEGIA G. (GEO)
127	GREENBERG O. (ISR)	131	TANG S. (GBR)	135	RADANOV N. (SRB)	139	RADANOV N. (SRB)
128	GLASER J. (GER)	132	GLASER J. (GER)	136	GLASER J. (GER)	140	GLASER J. (GER)

FINAL RESULTS	
1. FEDORA Ferenc	HUN
2. SODANO Raffaele	ITA
3. DARISPANASHVILI Luka	GEO
5. KAPANADZE Giorgi	GEO
5. MUNIZ ACOSTA Jakub	POL
7. GEGIA Giorgi	GEO
7. RADANOV Nikola	SRB





Porec Millennium Team Cadet European Cup 2025

Croatia, Porec, 15-16 Mar 2025

-66 kg

Men (94)

POOL C

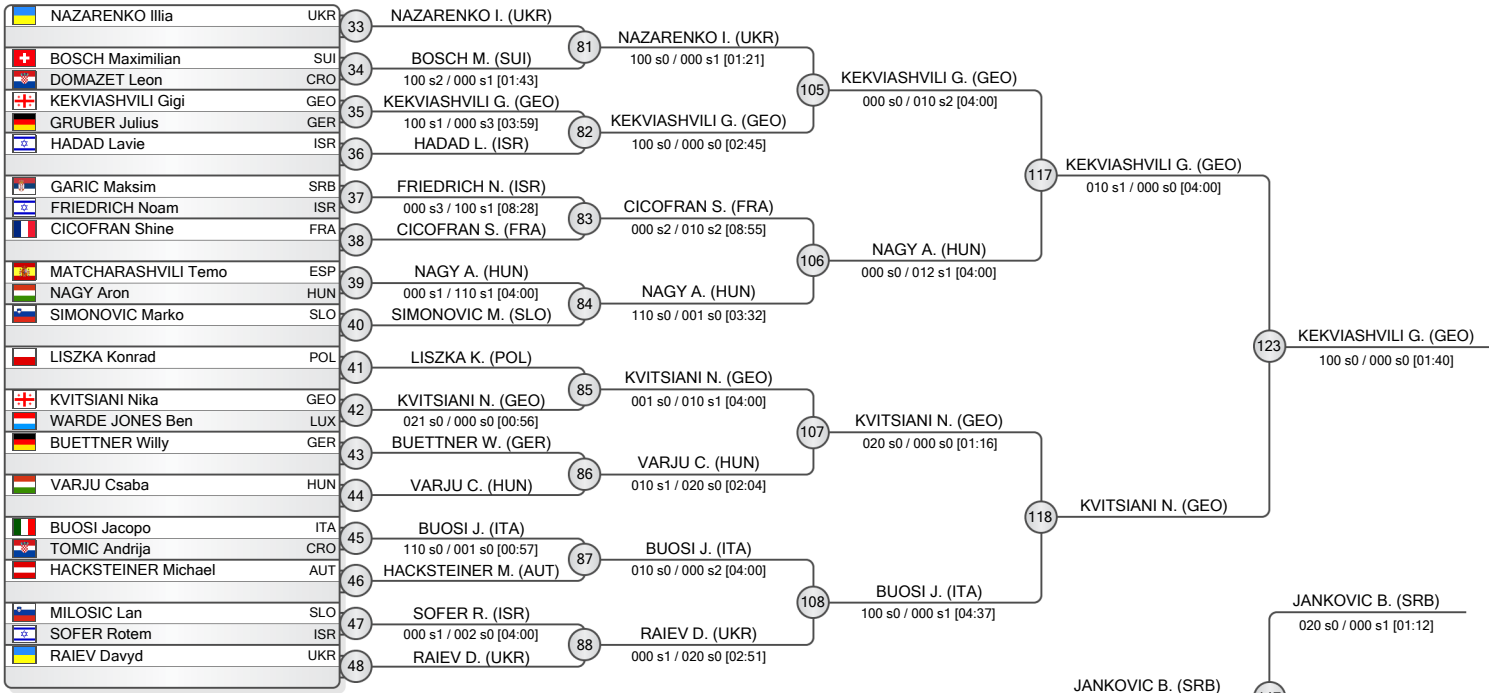

POOL D

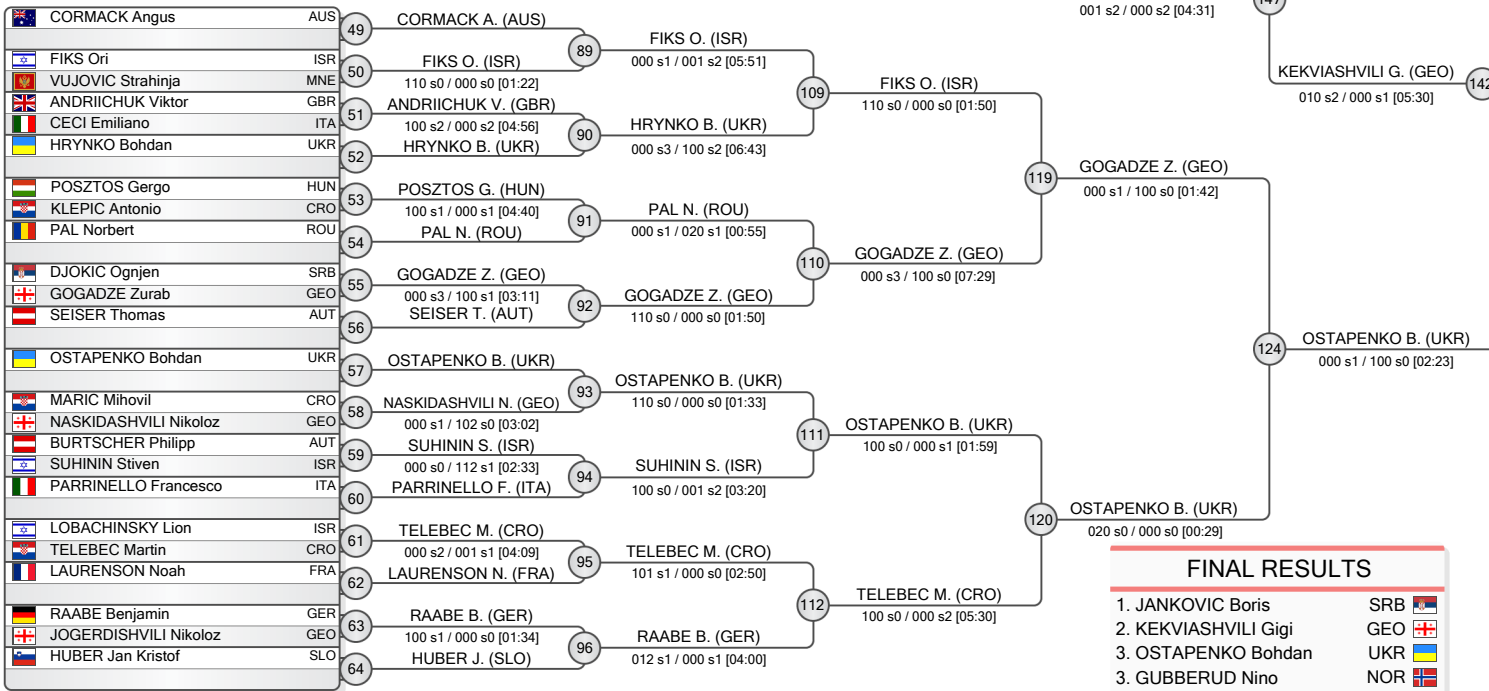

FINAL RESULTS

1.	JANKOVIC Boris	SRB
2.	KEKVIASHVILI Gigi	GEO
3.	OSTAPENKO Bohdan	UKR
3.	GUBBERUD Nino	NOR
5.	IMERLISHVILI Luka	GEO
5.	GOGADZE Zurab	GEO
7.	STOEGMANN Stefan	AUT
7.	KVITSIANI Nika	GEO

REPECHAGE

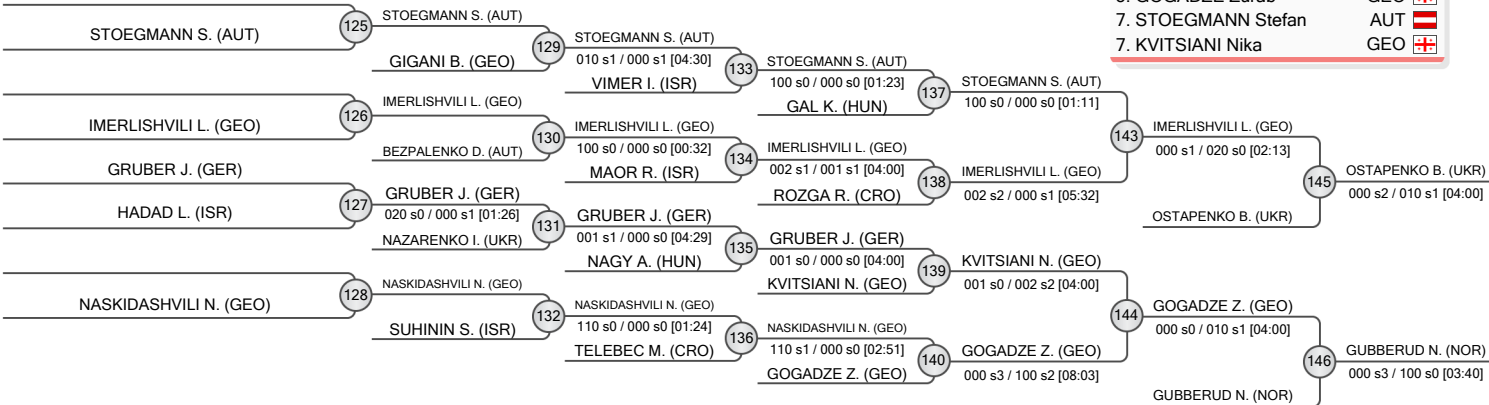



Porec Millennium Team Cadet European Cup 2025

Croatia, Porec, 15-16 Mar 2025

-73 kg

Men (77)

POOL A

MILJIC Sinisa	SRB	1	MILJIC S. (SRB)
PAVLOVIC Fredi	CRO	2	PAVLOVIC F. (CRO)
IKEME MASCARO Sergi	ESP	3	IKEME MASCARO S. (ESP)
ABASHIDZE Luka	GBR	4	ABASHIDZE L. (GBR)
VOROBEL Vitalii	UKR	5	BRUZHANITSKY T. (ISR)
BRUZHANITSKY Tal	ISR	6	KROTKO T. (SLO)
KROTKO Til	SLO	7	POHLMANN W. (GER)
POHLMANN Willi-Balduin	GER	8	MASATOVIC M. (CRO)
MASATOVIC Marin	CRO	9	HAMDAOUI A. (FRA)
HAMDAOUI Ahmed-Adam	FRA	10	TERJEK T. (HUN)
TERJEK Temes	HUN	11	ANKIC Andrej
ANKIC Andrej	SRB	12	SHERIPADZE D. (GEO)
SHERIPADZE Dachi	GEO	13	LAZAR M. (SVK)
LAZAR Milan	SVK	14	NAIDIUK V. (UKR)
NAIDIUK Volodymyr	UKR	15	HREN A. (CRO)
HREN Adrian	CRO	16	GVOZDENAC V. (BIH)
GVOZDENAC Vuk	BIH	17	FRELON Dan
FRELON Dan	SLO	18	DIRR J. (AUT)
DIRR Joe	AUT		

POOL B

LE BRIS Lowan	CAN	17	LE BRIS L. (CAN)
PIVNIUK Artem	UKR	18	POGGI M. (ITA)
KRMEK Roko Ivan	CRO	19	POGGI M. (ITA)
POGGI Matteo	ITA	20	TANCOCK L. (GBR)
TANCOCK Lenny	GBR	21	VRABETZ A. (AUT)
VRABETZ Alexander	AUT	22	STEVANOVIC GORJUP E. (SLO)
STEVANOVIC GORJUP Erik	SLO	23	JALIC U. (SRB)
MEDIC Vid	CRO	24	DE ANGELIS L. (SMR)
JALIC Uros	SRB	25	BORZECKI J. (POL)
DE ANGELIS Luca	SMR	26	MACHURIDZE V. (GEO)
BORZECKI Jakub	POL	27	ADROVIC L. (SLO)
MACHURIDZE Vladimir	GEO	28	BRIGGER I. (SUI)
ADROVIC Leon	SLO	29	TANASIJEVIC A. (SRB)
BRIGGER Ian	SUI	30	TANASIJEVIC A. (SRB)
GOMBKOTO Misa	HUN	31	MARIJANOVIC M. (BIH)
TANASIJEVIC Aleksa	SRB	32	BEN LAICHE E. (ISR)
GAURINA Josip	CRO		
MARIJANOVIC Mihajlo	BIH		
BEN LAICHE Edo	ISR		

REPECHAGE

PAVLOVIC F. (CRO)	125	PAVLOVIC F. (CRO)	129	IKEME MASCARO S. (ESP)	133	IKEME MASCARO S. (ESP)
IKEME MASCARO S. (ESP)		IKEME MASCARO S. (ESP)		BRUZHANITSKY T. (ISR)		BRUZHANITSKY T. (ISR)
POGGI M. (ITA)	126	POGGI M. (ITA)	130	LE BRIS L. (CAN)	134	LE BRIS L. (CAN)
LE BRIS L. (CAN)		LE BRIS L. (CAN)		JALIC U. (SRB)		JALIC U. (SRB)
KABRAN K. (FRA)	127	KABRAN K. (FRA)	131	MANGIAPIA D. (ITA)	135	MANGIAPIA D. (ITA)
MANGIAPIA D. (ITA)		MANGIAPIA D. (ITA)		VORON K. (UKR)		VORON K. (UKR)
KHARCHENKO M. (UKR)	128	KHARCHENKO M. (UKR)	132	NANAVA L. (GEO)	136	NANAVA L. (GEO)
NANAVA L. (GEO)		NANAVA L. (GEO)		GIGILASHVILI L. (GBR)		GIGILASHVILI L. (GBR)

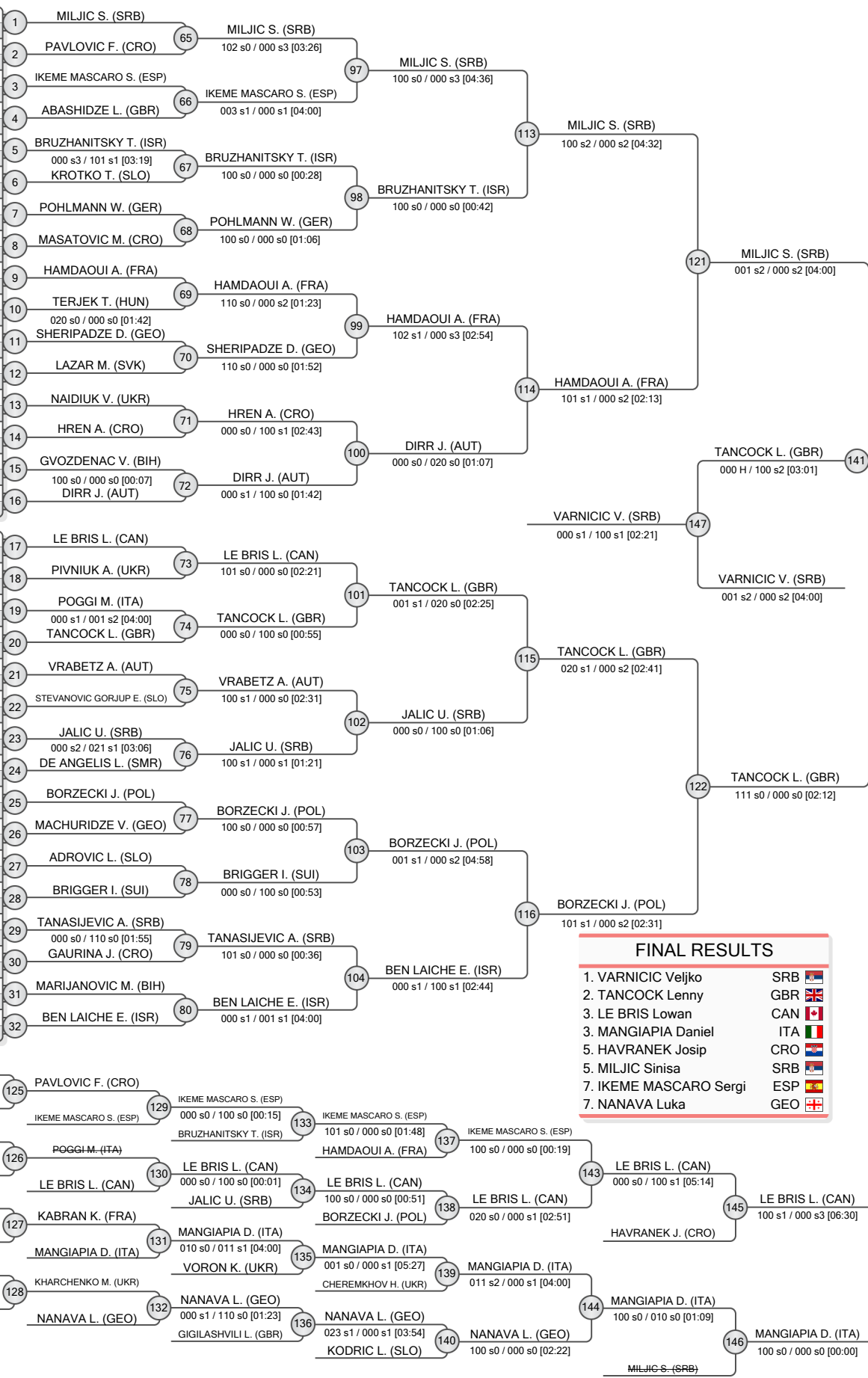

FINAL RESULTS	
1. VARNICIC Veljko	SRB
2. TANCOCK Lenny	GBR
3. LE BRIS Lowan	CAN
5. MANGIAPIA Daniel	ITA
5. HAVRANEK Josip	CRO
7. MILJIC Sinisa	SRB
7. IKEME MASCARO Sergi	ESP
7. NANAVA Luka	GEO





Porec Millennium Team Cadet European Cup 2025

Croatia, Porec, 15-16 Mar 2025

-73 kg

Men (77)

POOL C

	VARNIC V. (SRB)	33
	KABRAN K. (FRA)	34
	TRISIC Andrej	35
	MANGIAPIA Daniel	35
	LANTOS Levente	36
	TCHKADUA Data	37
	DJURISIC Balsa	38
	VORON Kyrilo	39
	ANDRIC Luka	40
	LOMOVSEK-KALAR A. (SLO)	40
	CHEREMKHOV Hryhorii	41
	FEKECS Gyula	42
	ANASTASOV Andrej	42
	POGGIALI Luca	43
	HOGL Nikola	44
	GOLOB Roko	45
	WASSERMANN Yonathan	46
	PACHER Konstantin	47
	MUHIC Miha	47
	SCHUMACHER Till	48

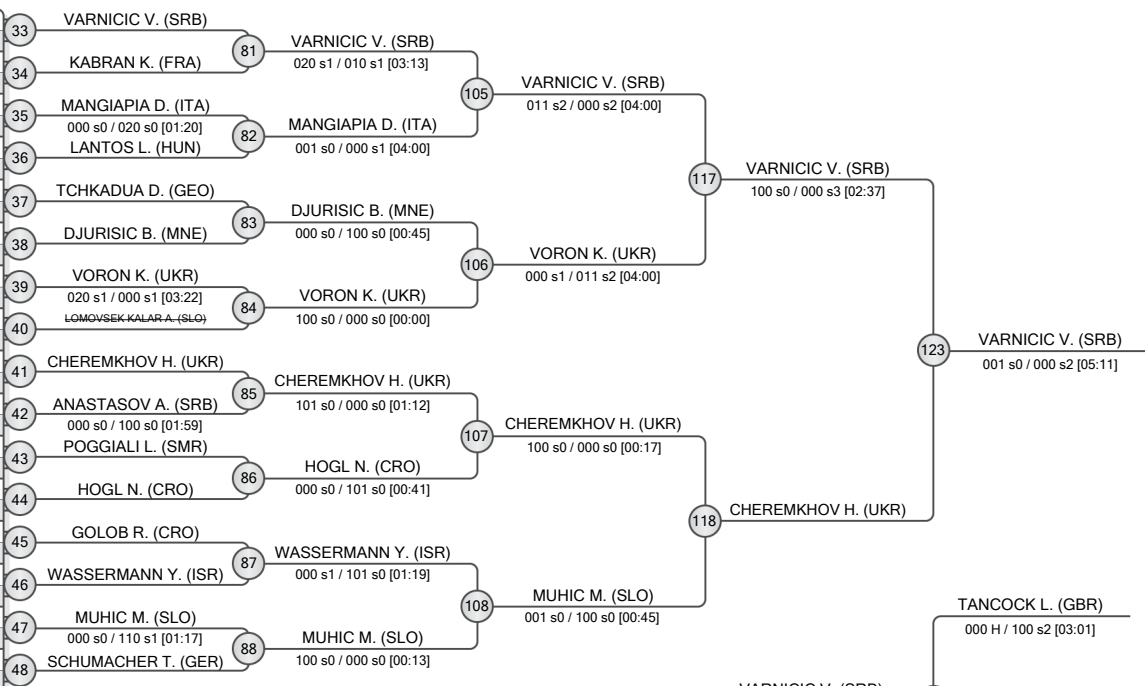

POOL D

	HAVRANEK Josip	49
	KHARCHENKO Mykyta	50
	SHADI Mohamed	51
	NANAVA Luka	52
	SPOLJARIC Lovro	53
	GIGILASHVILI Luka	53
	ENGET Edvard	54
	MANOJLOVIC Dusan	55
	CEBULJ Maks	56
	KODRIC Luka	57
	OLJIC Matej Jakov	58
	MAKSIMOVIC Vuk	58
	PERTSEV Emile	59
	HERNADI Csanad	60
	OSKIN Iliia	61
	SAMSIANI Ieso	62
	GARELLI Giacomo	63
	RAJCIC Marko	63
	STAJCIC Vasilije	64

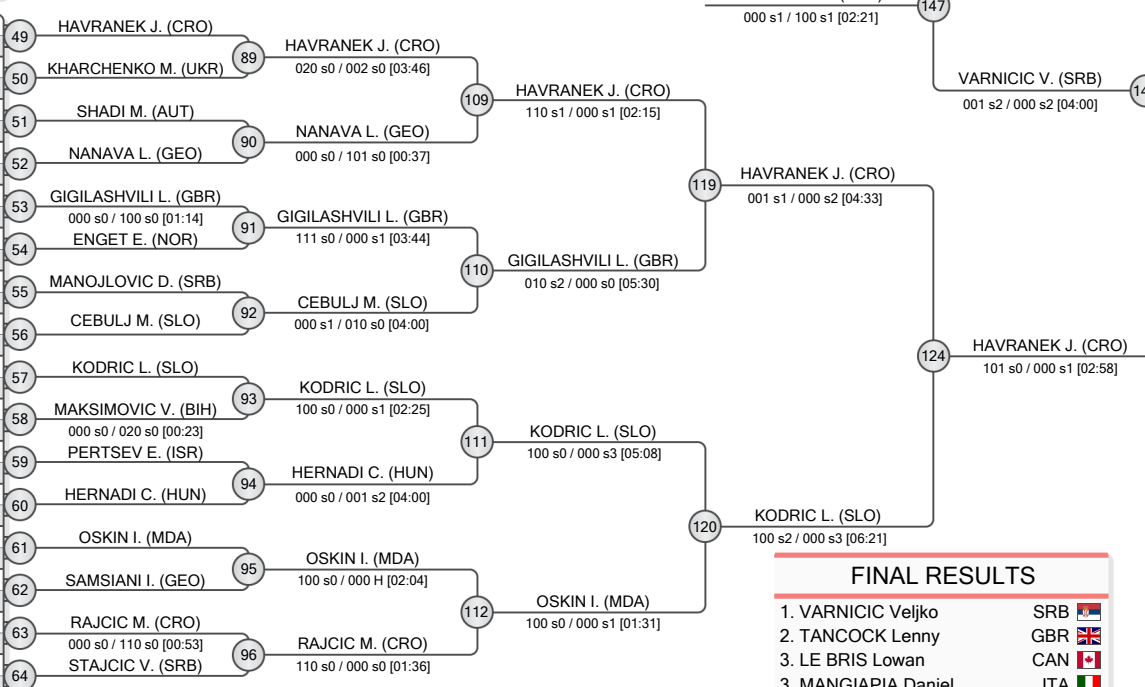

FINAL RESULTS	
1. VARNIC V. Veljko	SRB
2. TANCOCK Lenny	GBR
3. LE BRIS Lowan	CAN
3. MANGIAPIA Daniel	ITA
5. HAVRANEK Josip	CRO
5. MILJIC Sinisa	SRB
7. IKEME MASCARO Sergi	ESP
7. NANAVA Luka	GEO

REPECHAGE

	PAVLOVIC F. (CRO)	125
	IKEME MASCARO S. (ESP)	129
	POGGIALI Luca	126
	LE BRIS L. (CAN)	130
	KABRAN K. (FRA)	127
	KHARCHENKO M. (UKR)	128

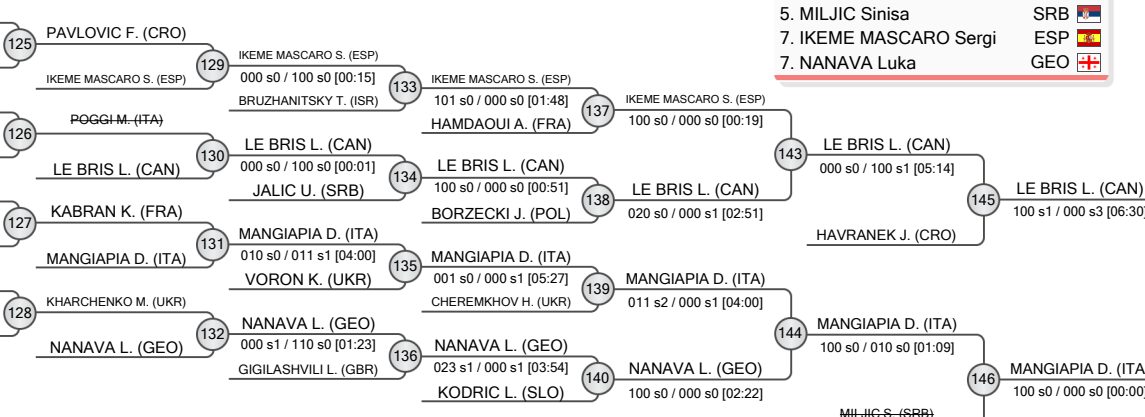



Porec Millennium Team Cadet European Cup 2025

Croatia, Porec, 15-16 Mar 2025

-81 kg

Men (64)

POOL A

1	BABAICENKO Tajus (LTU)	1	BABAICENKO T. (LTU)	100 s0 / 000 s1 [01:57]	33	BABAICENKO T. (LTU)	020 s0 / 000 s0 [00:44]
2	SINCHUK Vladyslav (UKR)	2	JALSOVEC N. (CRO)	000 s0 / 100 s0 [01:37]			
3	ARBULLA Alessandro (ITA)	3	MAN D. (ROU)	001 s1 / 021 s2 [03:25]	34	MAN D. (ROU)	010 s2 / 000 s2 [04:54]
4	JALSOVEC Nikola (CRO)	4	TULIK O. (HUN)	000 s0 / 100 s0 [00:51]			
5	PERRIN Leandre (FRA)	5	KOVSE M. (SLO)	100 s0 / 000 s1 [01:54]	35	BUZIASHVILI L. (GEO)	000 s1 / 100 s0 [01:43]
6	MAN Darius (ROU)	6	BUZIASHVILI L. (GEO)	000 s0 / 111 s0 [02:43]			
7	VAVPOTIC Anze (SLO)	7	MARGREITER S. (AUT)	001 s2 / 000 s2 [04:15]	36	ASHKENAZI T. (ISR)	000 s0 / 100 s0 [00:30]
8	TULIK Oliver (HUN)	8	ASHKENAZI T. (ISR)	100 s0 / 000 s3 [03:24]			

POOL B

9	KRIVEC Aleks (SLO)	9	KRIVEC A. (SLO)	020 s0 / 001 s0 [01:36]	37	KRIVEC A. (SLO)	001 s0 / 000 s1 [04:00]
10	ANTUNOVIC Teo (CRO)	10	SHNIDERMAN L. (ISR)	100 s0 / 000 s0 [00:20]			
11	SHNIDERMAN Liray (ISR)	11	STREICHER K. (FRA)	100 s0 / 000 s1 [01:53]	38	STREICHER K. (FRA)	100 s0 / 000 s0 [00:49]
12	BIELSA GONZALEZ Izan (ESP)	12	RAKOCEVIC N. (SRB)	001 s0 / 011 s1 [04:00]			
13	STREICHER Kellian (FRA)	13	BETKOWSKI J. (POL)	021 s0 / 000 s1 [03:11]	39	BETKOWSKI J. (POL)	003 s0 / 000 s1 [04:00]
14	CANEPARI Riccardo (ITA)	14	BEYELER G. (SUI)	000 s0 / 100 s0 [00:58]			
15	KORPAR LEMAC Stribor (CRO)	15	MUSELIANI S. (GEO)	001 s2 / 000 s0 [04:00]	40	MUSELIANI S. (GEO)	110 s0 / 000 s0 [01:07]
16	RAKOCEVIC Nikola (SRB)	16	VULIN V. (BIH)	000 s0 / 021 s0 [02:22]			

POOL C

17	KELLY Akos (AUS)	17	KELLY A. (AUS)	010 s1 / 000 s2 [04:00]	41	WOERMANSEDER K. (AUT)	000 s0 / 020 s0 [01:36]
18	DAVIDASHVILY Yakov (ISR)	18	WOERMANSEDER K. (AUT)	001 s0 / 101 s0 [01:48]			
19	SIPUSIC Jan (CRO)	19	SVETEC S. (SLO)	021 s0 / 000 s1 [02:40]	42	BONGAMBE E. (FRA)	000 s0 / 100 s0 [02:10]
20	WOERMANSEDER Klaus (AUT)	20	BONGAMBE E. (FRA)	000 s0 / 101 s0 [03:05]			
21	SVETEC Stas (SLO)	21	SEMANJAKU E. (ITA)	101 s0 / 000 s0 [01:43]	43	SEMANJAKU E. (ITA)	110 s1 / 000 s2 [02:44]
22	FREIRE GONZALEZ Nicolas (ESP)	22	SINJER N. (MDA)	002 s1 / 000 s1 [04:00]			
23	VIDAKOVIC Vuk (SRB)	23	MARTINEZ KOVAC J. (SLO)	100 s0 / 000 s0 [02:04]	44	SAMSIANI S. (GEO)	000 s0 / 100 s0 [00:26]
24	BONGAMBE Evan (FRA)	24	SAMSIANI S. (GEO)	110 s0 / 000 s1 [00:43]			

POOL D

25	OBRADOVIC Nikola (SRB)	25	OBRADOVIC N. (SRB)	100 s0 / 000 s2 [02:57]	45	OBRADOVIC N. (SRB)	012 s1 / 000 s2 [04:00]
26	BERIANIDZE Rati (GEO)	26	MEIER G. (LIE)	001 s2 / 000 s0 [04:00]			
27	MEIER Gabriel (LIE)	27	SVALINA N. (CRO)	110 s0 / 000 s0 [01:26]	46	SVALINA N. (CRO)	001 s1 / 000 s1 [04:00]
28	VASIC Vladislav (SLO)	28	SCHEIBER F. (AUT)	000 s1 / 110 s1 [01:48]			
29	SVALINA Nikola (CRO)	29	RUSSO E. (ITA)	100 s0 / 000 s0 [00:11]	47	RUSSO E. (ITA)	101 s0 / 001 s1 [02:45]
30	ZUCCHERI Leonardo (ITA)	30	PERECZ M. (HUN)	100 s1 / 000 s2 [04:13]			
31	LECHOWICZ Marek (POL)	31	SHENGELIA N. (GBR)	020 s0 / 000 s0 [00:20]	48	SAKHAROV N. (UKR)	000 s1 / 100 s1 [05:39]
32	SCHEIBER Felix (AUT)	32	SAKHAROV N. (UKR)	011 s0 / 001 s0 [04:00]			

REPECHAGE

61	SINCHUK V. (UKR)	61	SINCHUK V. (UKR)	100 s0 / 000 s0 [00:34]	65	SINCHUK V. (UKR)	100 s1 / 000 s1 [01:47]
62	JALSOVEC N. (CRO)	62	SHNIDERMAN L. (ISR)	000 s0 / 110 s0 [00:32]	66	SHNIDERMAN L. (ISR)	001 s1 / 000 s2 [05:31]
63	ANTUNOVIC T. (CRO)	63	MARTINEZ KOVAC J. (SLO)	100 s0 / 000 s0 [01:04]	67	SEMANJAKU E. (ITA)	000 s1 / 020 s1 [03:46]
64	SHNIDERMAN L. (ISR)	64	FILIP A. (FRA)	100 s0 / 000 s0 [01:04]	68	RUSSO E. (ITA)	000 s0 / 010 s1 [04:00]
65	SHNIDERMAN L. (ISR)	65	RUSSO E. (ITA)	000 s0 / 010 s1 [04:00]	69	OBRADOVIC N. (SRB)	000 s3 / 100 s0 [00:55]
66	DJEKOVIC V. (SRB)	66	STREICHER K. (FRA)	100 s0 / 000 s0 [01:04]	70	BETKOWSKI J. (POL)	000 s3 / 100 s1 [03:19]
67	MARTINEZ KOVAC J. (SLO)	67	SEMANJAKU E. (ITA)	000 s1 / 020 s1 [03:46]	71	BONGAMBE E. (FRA)	000 s0 / 010 s1 [04:00]
68	FILIP A. (FRA)	68	RUSSO E. (ITA)	000 s0 / 010 s1 [04:00]	72	OBRADOVIC N. (SRB)	000 s3 / 100 s0 [00:55]
69	SHENGELIA N. (GBR)	69	OBRADOVIC N. (SRB)	000 s3 / 100 s0 [00:55]	73	BABAICENKO T. (LTU)	100 s1 / 000 s2 [04:13]
70	SHENGELIA N. (GBR)	70	BETKOWSKI J. (POL)	000 s3 / 100 s1 [03:19]	74	SAMSIANI S. (GEO)	021 s0 / 010 s0 [03:16]
71	DJEKOVIC V. (SRB)	71	BONGAMBE E. (FRA)	000 s0 / 010 s1 [04:00]	75	BETKOWSKI J. (POL)	000 s3 / 100 s2 [07:33]
72	MARTINEZ KOVAC J. (SLO)	72	OBRADOVIC N. (SRB)	000 s3 / 100 s0 [00:55]	76	SAKHAROV N. (UKR)	001 s2 / 010 s0 [04:00]
73	FILIP A. (FRA)	73	KRIVEC A. (SLO)	020 s0 / 000 s1 [01:44]	77	SAKHAROV N. (UKR)	001 s2 / 010 s0 [04:00]
74	SHENGELIA N. (GBR)	74	KRIVEC A. (SLO)	010 s0 / 000 s2 [04:00]	78	KRIVEC A. (SLO)	000 s0 / 011 s1 [04:00]
75	ANTUNOVIC T. (CRO)	75	BETKOWSKI J. (POL)	000 s3 / 100 s2 [07:33]	79	BABAICENKO T. (LTU)	101 s0 / 010 s1 [03:20]
76	SHNIDERMAN L. (ISR)	76	SAKHAROV N. (UKR)	000 s1 / 001 s1 [04:00]			
77	DJEKOVIC V. (SRB)	77	SAKHAROV N. (UKR)	000 s1 / 001 s1 [04:00]			
78	MARTINEZ KOVAC J. (SLO)	78	KRIVEC A. (SLO)	020 s0 / 000 s1 [01:44]			
79	FILIP A. (FRA)	79	BABAICENKO T. (LTU)	101 s0 / 010 s1 [03:20]			

FINAL RESULTS

- BABAICENKO Tajus (LTU)
- SAMSIANI Saba (GEO)
- SAKHAROV Nikita (UKR)
- KRIVEC Aleks (SLO)
- BETKOWSKI Jeremiasz (POL)
- OBRADOVIC Nikola (SRB)
- SINCHUK Vladyslav (UKR)
- BONGAMBE Evan (FRA)





Porec Millennium Team Cadet European Cup 2025

Croatia, Porec, 15-16 Mar 2025

-90 kg

Men (41)

POOL A

1	SIMIC Nemanja (SRB)	33	SIMIC N. (SRB)
2	RADULOVIC Jovan (MNE)	110 s2 / 000 s0 [02:59]	101 s1 / 000 s1 [02:39]
3	FERNANDEZ CALERO Pablo (ESP)		
4	VUJICIC Dusan (BIH)	34	VUJICIC D. (BIH)
5	MILKOVIC Bojan (CRO)		100 s1 / 000 s0 [00:38]
6	SVATEK Jozef (SVK)	35	VUJICA M. (CRO)
7	MORONI Leonardo (ITA)		011 s0 / 000 s2 [04:00]
8	SIKHASHVILI Saba (GEO)	36	NEACSU R. (ROU)
	NEACSU Rares (ROU)		000 s0 / 100 s0 [00:19]

POOL B

9	SUNDBY Marius (NOR)	37	SUNDBY M. (NOR)
10	MARX Gregor (AUT)		100 s0 / 000 s0 [02:13]
11	SKOPAC Jakov (CRO)		
12	JOVIC Dragan (SRB)	38	JOVIC D. (SRB)
13	MARINO Fabrizio (ITA)		101 s2 / 000 s2 [03:01]
14	FRANCA Aljaz (SLO)	39	SIKULJAK R. (BIH)
15	TOTH Zsombor (HUN)		000 s2 / 010 s2 [04:57]
16	SIKULJAK Relja (BIH)		000 s1 / 011 s1 [04:00]
	BOYUNGA BOKULUTA Elie (UKR)	40	PEREVERTAILO K. (UKR)
	PEREVERTAILO Kyrylo (UKR)		000 s0 / 020 s0 [01:06]
	OHAYON Noam (ISR)		101 s0 / 001 s0 [02:27]

POOL C

17	QUINTEROS Tomas (ARG)	41	MULTON KANDU MPALA C. (FRA)
18	MULTON KANDU MPALA Cedric (FRA)		000 s0 / 020 s0 [02:09]
19	SIUKASHVILI Sandro (GEO)		
20	STANEV Zdravko (BUL)	42	MAKARENKO A. (UKR)
21	MAKARENKO Artur (UKR)		000 s1 / 020 s0 [02:02]
22	HORNGACHER Lorenz (AUT)	43	HORNGACHER L. (AUT)
23	MAIANO Alessio (ITA)		010 s2 / 000 s2 [04:00]
24	SALAMON Barnabas (HUN)	44	SALAMON B. (HUN)
	JERKUNICA Anton (CRO)		100 s0 / 000 s0 [00:08]
	POPOVIC Petar (BIH)		100 s0 / 000 s0 [00:15]

POOL D

25	MAZZON Francesco (ITA)	45	MAZZON F. (ITA)
26	VALENTIN Jeremy (LUX)		100 s1 / 000 s0 [01:46]
27	RUDIC Luka (CRO)		000 s3 / 100 s1 [02:35]
28	KOPRIVICA Jovan (SRB)	46	KOGUASHVILI G. (GEO)
29	KOGUASHVILI Giorgi (GEO)		000 s0 / 100 s0 [00:51]
30	CAPEZZUTO Antonio (ITA)	47	CAPEZZUTO A. (ITA)
31	POPOVIC Andrija (MNE)		020 s0 / 000 s2 [02:06]
32	SEGUIN RENDAL Ian (ESP)	48	HECKO D. (SVK)
	VOJINOVIC Lazar (BIH)		000 s0 / 100 s0 [00:00]
	HECKO Daniel (SVK)		

REPECHAGE

61	RADULOVIC J. (MNE)	65	VUJICIC D. (BIH)
62	BOYUNGA BOKULUTA E. (FRA)		000 s0 / 100 s0 [00:36]
63	OHAYON N. (ISR)	66	OHAYON N. (ISR)
			100 s0 / 000 s0 [00:12]
64	STANEV Z. (BUL)	67	MULTON KANDU MPALA C. (FRA)
			000 s2 / 100 s1 [03:08]
		68	KOGUASHVILI G. (GEO)
			000 s1 / 102 s1 [03:00]

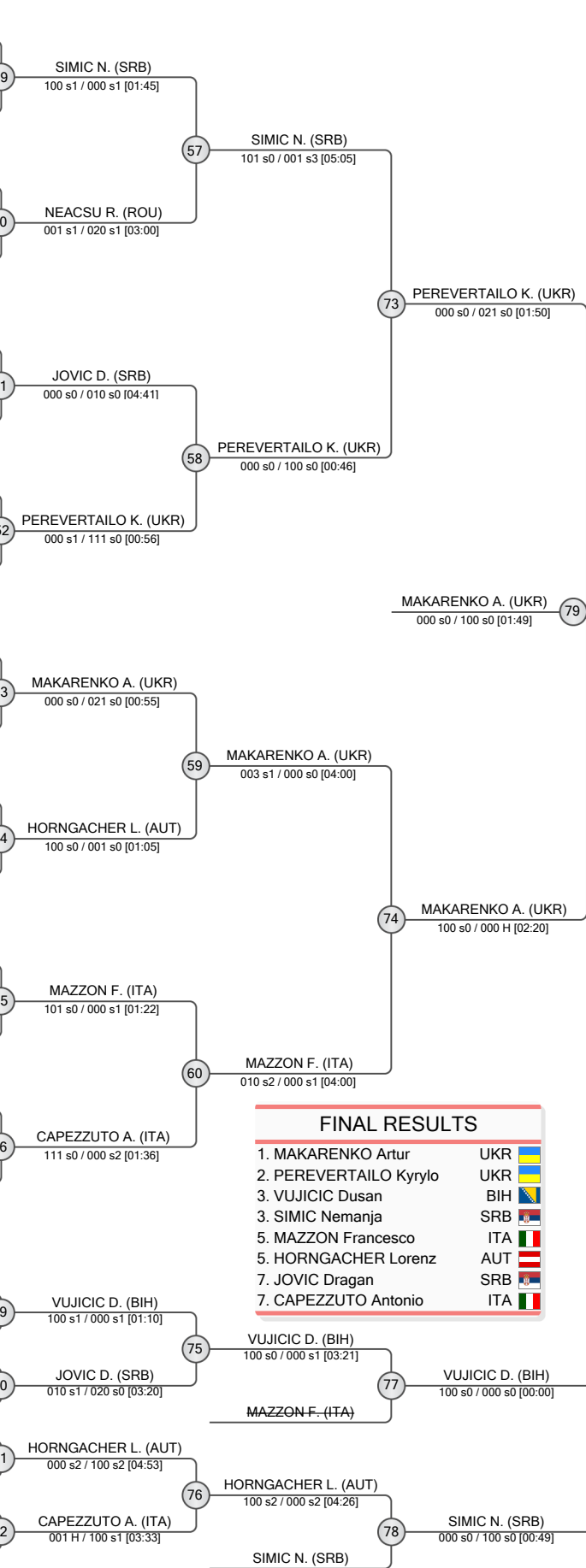

FINAL RESULTS		
1.	MAKARENKO Artur	UKR
2.	PEREVERTAILO Kyrylo	UKR
3.	VUJICIC Dusan	BIH
3.	SIMIC Nemanja	SRB
5.	MAZZON Francesco	ITA
5.	HORNGACHER Lorenz	AUT
7.	JOVIC Dragan	SRB
7.	CAPEZZUTO Antonio	ITA





Porec Millennium Team Cadet European Cup 2025

Croatia, Porec, 15-16 Mar 2025

+ 90 kg

Men (26)

POOL A

	NOVAKOVIC Petar	SRB
	HUBKO Yehor	UKR
	IVOSIC Vito	CRO
	CORSICA Michele	ITA
	PLESCA Catalin	MDA
	KASHIBADZE Giorgi	GEO
	ZAMAI Zakhar	UKR

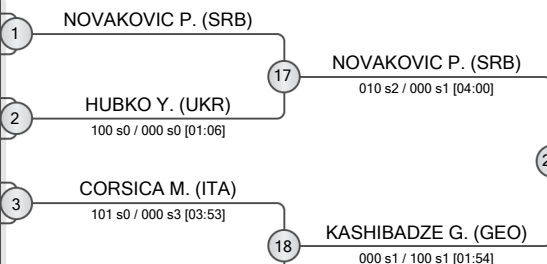

POOL B

	PICCHI Gianluca	ITA
	TITAN Ohad	ISR
	APTSIAURI Nikoloz	GEO
	CSERMAK Daniel	HUN
	MRSIC Roko	CRO
	NAZARCHUK Daniil	UKR

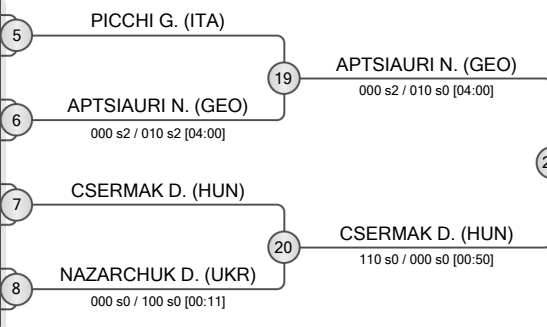

POOL C

	LUBURA Nikola	BIH
	TIUKH Yurii	UKR
	ZAKUTASHVILI Ilia	GEO
	ANGERER Lukas	AUT
	FRANGEZ Gal	SLO
	MIKOLA Niko	CRO
	FALUSI Zsolt	HUN

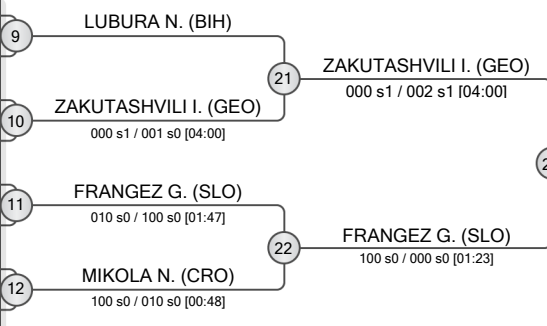

POOL D

	SZEKERES Abel	HUN
	BISCHOFF Samuel	GER
	ZHADAN Serhii	UKR
	DAVRASHELIDZE Hamlet	GEO
	MARIC Luka	SRB
	CVITKOVIC Ivan	CRO

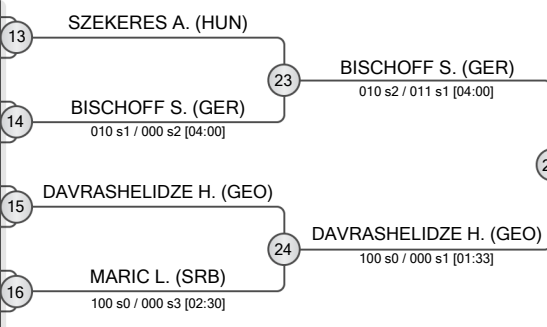

REPECHAGE

ZAMAI Z. (UKR)	CORSICA M. (ITA)	29
CORSICA M. (ITA)	NOVAKOVIC P. (SRB)	33
NAZARCHUK D. (UKR)	APTSIAURI N. (GEO)	30
TIUKH Y. (UKR)	LUBURA N. (BIH)	31
LUBURA N. (BIH)	FRANGEZ G. (SLO)	35
MARIC L. (SRB)	MARIC L. (SRB)	32
MARIC L. (SRB)	BISCHOFF S. (GER)	36

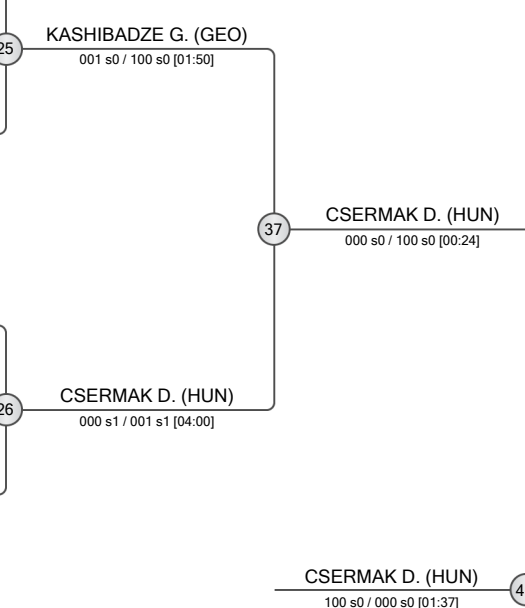
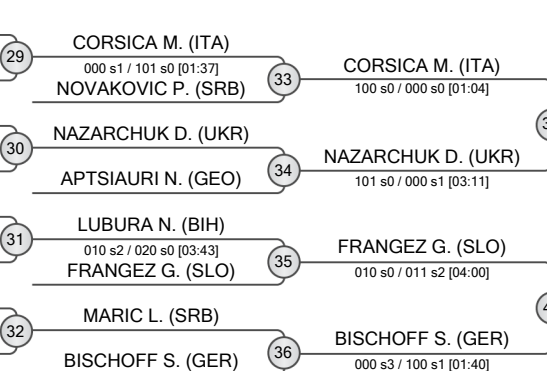

FINAL RESULTS

1. CSERMAK Daniel HUN
2. ZAKUTASHVILI Ilia GEO
3. CORSICA Michele ITA
3. BISCHOFF Samuel GER
5. DAVRASHELIDZE Hamlet GEO
5. KASHIBADZE Giorgi GEO
7. NAZARCHUK Daniil UKR
7. FRANGEZ Gal SLO





Porec Millennium Team Cadet European Cup 2025

Croatia, Porec, 15-16 Mar 2025

-40 kg

Women (14)

POOL A

	RADICS Maja	HUN
	HUSEYNOVA Madina	AZE
	MARIAN Daria	ROU

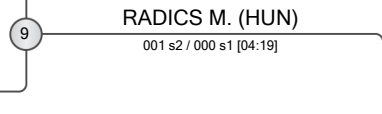
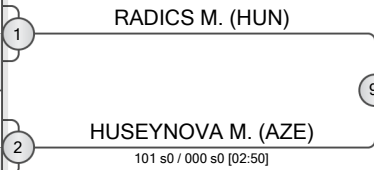

POOL B

	GRESI Flavia	ITA
	HRYHORENKO Anna	UKR
	REMIGIO RUIZ Nadia	ESP
	COLOMBAT Thais	FRA

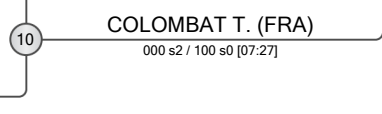
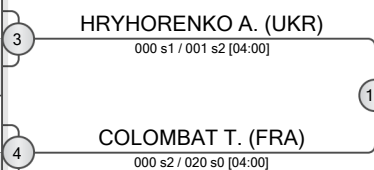

POOL C

	PIRBUS-GROF Nora	HUN
	CARNIATO Martina	ITA
	PALAMARENKO Sofiiia	UKR

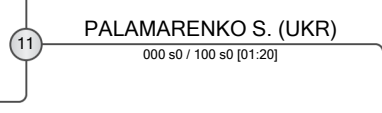
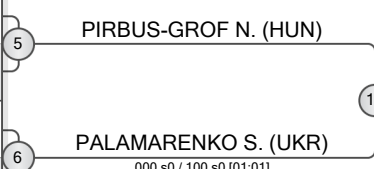

POOL D

	VUKMIROVIC Hana	SRB
	LAVERGNE Joanne	FRA
	TAKACS Nora	HUN
	TURSI Giada	ITA

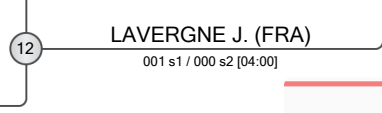

FINAL RESULTS		
1.	RADICS Maja	HUN
2.	PALAMARENKO Sofiiia	UKR
3.	HUSEYNOVA Madina	AZE
3.	TURSI Giada	ITA
5.	LAVERGNE Joanne	FRA
5.	COLOMBAT Thais	FRA
7.	HRYHORENKO Anna	UKR
7.	CARNIATO Martina	ITA

REPECHAGE

HUSEYNOVA M. (AZE)	13	HUSEYNOVA M. (AZE)
REMIGIO RUIZ N. (ESP)		
HRYHORENKO A. (UKR)	14	HRYHORENKO A. (UKR)
CARNIATO M. (ITA)		
PIRBUS-GROF N. (HUN)	15	CARNIATO M. (ITA)
VUKMIROVIC H. (SRB)		
TURSI G. (ITA)	16	TURSI G. (ITA)

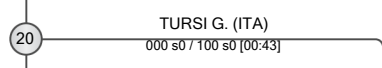
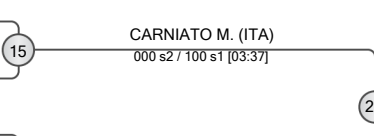
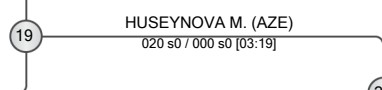
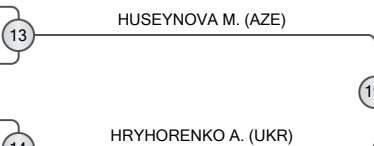



Porec Millennium Team Cadet European Cup 2025

Croatia, Porec, 15-16 Mar 2025

-44 kg

Women (36)

POOL A

	WALENZIK Sandra	POL	1	WALENZIK S. (POL)
	ROEDER Zoe	GER	2	ROEDER Z. (GER)
	PAUS Roni	ISR	3	PAUS R. (ISR)
	CIAVURRO Rachele	ITA	4	CIAVURRO R. (ITA)
	BLASZCZYK Julia	POL	5	BLASZCZYK J. (POL)
	SIMIC Marija	MNE	6	SIMIC M. (MNE)
	JOLY Ninon	FRA	7	JOLY N. (FRA)
	CUSA Carla	ROU		
	ABDULLAYEVA Khadija	AZE	8	ABDULLAYEVA K. (AZE)

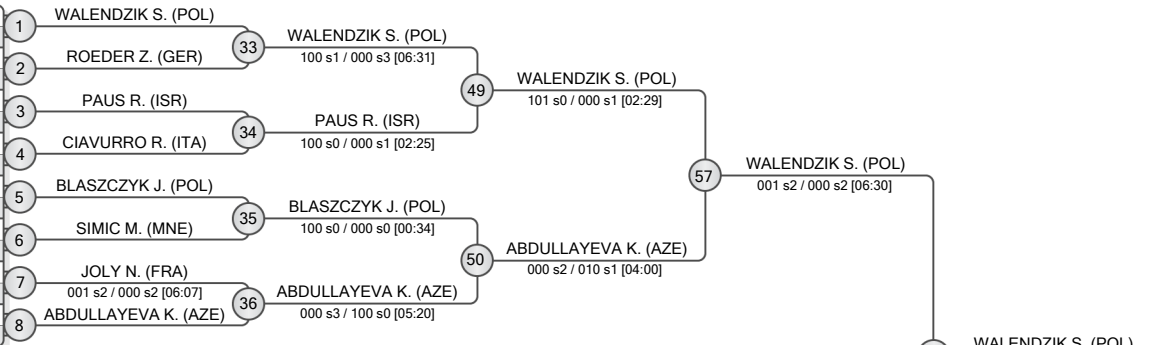

POOL B

	CONI Sara	GBR	9	CONI S. (GBR)
	FERRO Aurora	ITA	10	FERRO A. (ITA)
	URBAN Noemie	FRA	11	URBAN N. (FRA)
	ZAECH Helena	SUI		
	MARTIN TORRES Jimena	ESP	12	MARTIN TORRES J. (ESP)
	TEMPESTA Miriam	ITA	13	TEMPESTA M. (ITA)
	STARK Leeyam	ISR	14	STARK L. (ISR)
	MOSNJA Lara	CRO	15	MOSNJA L. (CRO)
	SMOLII Yuliia	UKR	16	SMOLII Y. (UKR)

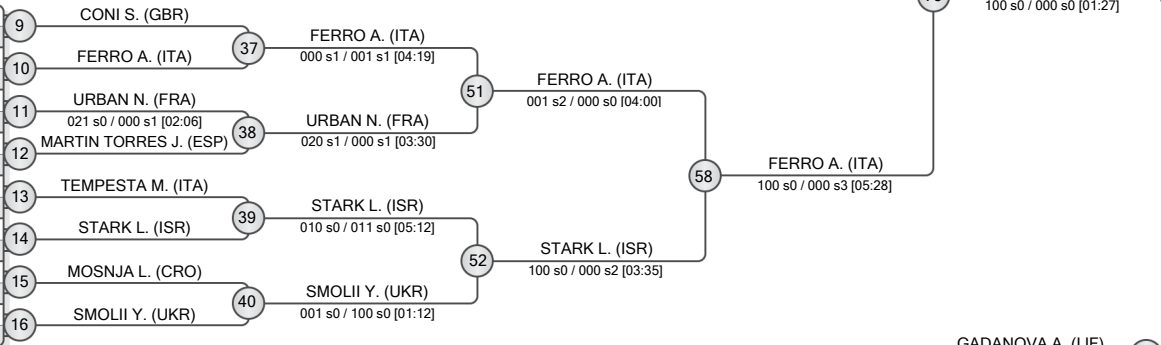

POOL C

	GABAY Yuval	ISR	17	GABAY Y. (ISR)
	HUSEYNOVA Gulshan	AZE	18	HUSEYNOVA G. (AZE)
	SZCZEPANSKA Julia	POL	19	GADANOVA A. (IJF)
	GADANOVA Alina	IJF		
	BROADLEY Maisie	GBR	20	BROADLEY M. (GBR)
	GORANOVIC Katarina	SRB	21	GORANOVIC K. (SRB)
	LONGO Sofia	ITA	22	LONGO S. (ITA)
	KATUSIC Nika	CRO	23	KATUSIC N. (CRO)
	RIEZNIC Vladyslava	UKR	24	RIEZNIC V. (UKR)

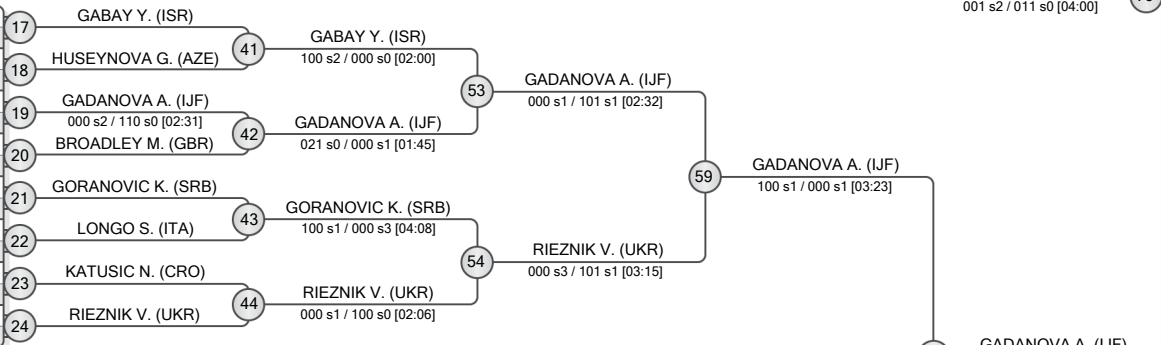

POOL D

	SERBAN Denisa	ROU	25	SERBAN D. (ROU)
	ABDULLAYEVA Fatima	AZE	26	ABDULLAYEVA F. (AZE)
	MARTINEZ GALVEZ Maria Jesus	ESP	27	MARTINEZ GALVEZ M. (ESP)
	STORIONE Ludovica	ITA	28	STORIONE L. (ITA)
	TIGANOV Cristina	ITA	29	TIGANOV C. (ITA)
	DRAKSIC KOSTOMAJ Nastja	SLO	30	DRAKSIC KOSTOMAJ N. (SLO)
	HARPAZ UYAR Liam	ISR	31	VUKSANOVIC T. (CRO)
	VUKSANOVIC Tena	CRO		
	SPITZ Ines	FRA	32	SPITZ I. (FRA)

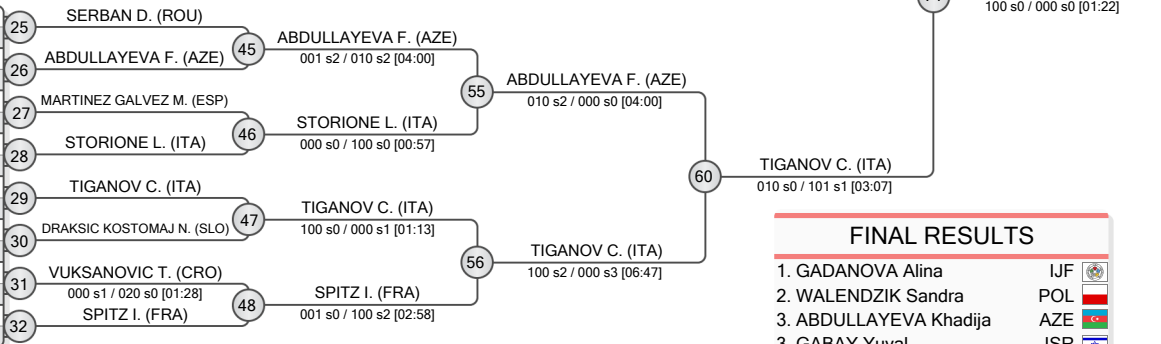

FINAL RESULTS		
1.	GADANOVA Alina	IJF
2.	WALENZIK Sandra	POL
3.	ABDULLAYEVA Khadija	AZE
3.	GABAY Yuval	ISR
5.	TIGANOV Cristina	ITA
5.	FERRO Aurora	ITA
7.	CONI Sara	GBR
7.	ABDULLAYEVA Fatima	AZE

REPECHAGE

	ROEDER Z. (GER)	61	ROEDER Z. (GER)	65	ROEDER Z. (GER)	69	ABDULLAYEVA K. (AZE)
			PAUS R. (ISR)		CONI S. (GBR)		ABDULLAYEVA K. (AZE)
	CONI S. (GBR)	62	CONI S. (GBR)	66	CONI S. (GBR)	70	CONI S. (GBR)
	SZCZEPANSKA J. (POL)		URBAN N. (FRA)		STARK L. (ISR)		CONI S. (GBR)
	BROADLEY M. (GBR)	63	SZCZEPANSKA J. (POL)	67	GABAY Y. (ISR)	71	GABAY Y. (ISR)
			GABAY Y. (ISR)		RIEZNIC V. (UKR)		GABAY Y. (ISR)
	DRAKSIC KOSTOMAJ N. (SLO)	64	DRAKSIC KOSTOMAJ N. (SLO)	68	SPITZ I. (FRA)	72	ABDULLAYEVA F. (AZE)
			SPITZ I. (FRA)		ABDULLAYEVA F. (AZE)		ABDULLAYEVA F. (AZE)

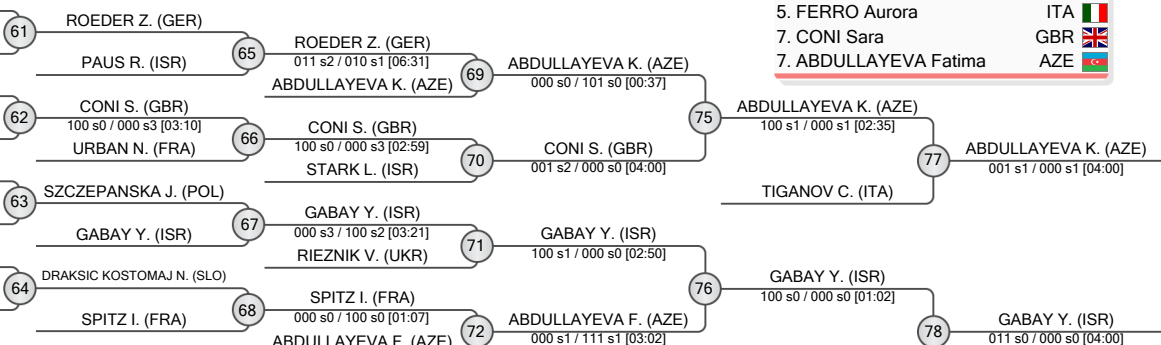



Porec Millennium Team Cadet European Cup 2025

Croatia, Porec, 15-16 Mar 2025

-48 kg

Women (49)

POOL A

1	TWAROWSKA Barbara (POL)	1	TWAROWSKA B. (POL)
2	STOJMILOVSKA Anamarija (MKD)	2	STOJMILOVSKA A. (MKD)
3	UGARKOVIC Petra (CRO)	3	BUCHANAN A. (GBR)
4	BUCHANAN Alexis (GBR)	4	ALOISE G. (ITA)
5	LARSEN Ria (SUI)	5	BRONZIN A. (ITA)
6	ALOISE Ginevra (ITA)	6	MAYRHOFER L. (AUT)
7	BRONZIN Alice (ITA)	7	MUNIZ DEL VALLE Daniela (ESP)
8	MAYRHOFER Lena (AUT)	8	VUKASOVIC Teodora (SRB)
			AGHAMIRZAZADE Narmin (AZE)
			PAPAI Stella (HUN)

POOL B

9	HERTA Gabriela (MDA)	9	HERTA G. (MDA)
10	RASIC Mara (SRB)	10	RASIC M. (SRB)
11	BRDAR Eva (CRO)	11	MATEJKOVA T. (SVK)
12	GANGL Anna (AUT)	12	DANIELE Chiara (ITA)
13	MATEJKOVA Teresa (SVK)	13	TUCAJ Martina (CRO)
14	DANIELE Chiara (ITA)	14	FELTRIN Flore (FRA)
15	TUCAJ Martina (CRO)	15	CORSI Margot (ITA)
16	FELTRIN Flore (FRA)	16	NOY Agam Sol (ISR)
			ALAKBAROVA Leyla (AZE)
			KARPUS Daria (UKR)

POOL C

17	HIROSE Rika (AUS)	17	HIROSE R. (AUS)
18	ARGAMAN Rani (ISR)	18	AHMADOVA N. (AZE)
19	AHMADOVA Nargiz (AZE)	19	SCHRODL E. (HUN)
20	ZVAJCKER Sara (SLO)	20	DARE Zayi (FRA)
21	SCHRODL Emma (HUN)	21	CHRISP Taylor (GBR)
22	DARE Zayi (FRA)	22	TRAMPITSCH Maja (AUT)
23	CHRISP Taylor (GBR)	23	SADIKU Anja (SRB)
24	TRAMPITSCH Maja (AUT)	24	LISOHOROVA Alona (UKR)
			KONVICNI Rima (CRO)
			MONTALBANO Aurora (ITA)

POOL D

25	KISS Viktoria (HUN)	25	KISS V. (HUN)
26	TREBBI Tatiana (ITA)	26	PETRENKO L. (UKR)
27	PETRENKO Liliia (UKR)	27	MAMISHOVA N. (AZE)
28	VASILEVA Raya (BUL)	28	PULJIC Lucija (CRO)
29	MAMISHOVA Nigar (AZE)	29	TANACKOV Marija (SRB)
30	PULJIC Lucija (CRO)	30	CULJAK Petra (BIH)
31	TANACKOV Marija (SRB)	31	STOEGMANN Isabella (AUT)
32	CULJAK Petra (BIH)	32	KOCHER Aline (SUI)
			VRCINAC Milana (SRB)
			AIROLA GRANACI Iulia (ITA)
			MARTIN CARRICHES Aiora (ESP)

REPECHAGE

61	STOJMILOVSKA A. (MKD)	61	STOJMILOVSKA A. (MKD)
62	NOY A. (ISR)	62	KARPUS D. (UKR)
63	KARPUS D. (UKR)	63	KONVICNI R. (CRO)
64	KONVICNI R. (CRO)	64	AIROLA GRANACI I. (ITA)
65	ALOISE G. (ITA)	65	STOJMILOVSKA A. (MKD)
66	KARPUS D. (UKR)	66	CHRISP T. (GBR)
67	TUCAJ M. (CRO)	67	AIROLA GRANACI I. (ITA)
68	TUCAJ M. (CRO)	68	STOEGMANN I. (AUT)
69	STOJMILOVSKA A. (MKD)	69	AIROLA GRANACI I. (ITA)
70	HERTA G. (MDA)	70	KISS V. (HUN)
71	HERTA G. (MDA)	71	STOEGMANN I. (AUT)
72	DARE Z. (FRA)	72	KISS V. (HUN)
73	HERTA G. (MDA)	73	ALAKBAROVA L. (AZE)
74	MONTALBANO A. (ITA)	74	ALAKBAROVA L. (AZE)
75	HERTA G. (MDA)	75	ALAKBAROVA L. (AZE)
76	DARE Z. (FRA)	76	ALAKBAROVA L. (AZE)
77	HERTA G. (MDA)	77	ALAKBAROVA L. (AZE)
78	KISS V. (HUN)	78	ALAKBAROVA L. (AZE)
79	ALAKBAROVA L. (AZE)	79	ALAKBAROVA L. (AZE)

FINAL RESULTS

- TWAROWSKA Barbara (POL)
- MARTIN CARRICHES Aiora (ESP)
- HERTA Gabriela (MDA)
- KISS Viktoria (HUN)
- MONTALBANO Aurora (ITA)
- ALAKBAROVA Leyla (AZE)
- STOJMILOVSKA Anamarija (MKD)
- DARE Zayi (FRA)





Porec Millennium Team Cadet European Cup 2025

Croatia, Porec, 15-16 Mar 2025

-52 kg

Women (46)

POOL A

VAS Mira (HUN)	1	VAS M. (HUN)	33	DODAJ S. (KOS)
TEISANU Teodora (ROU)	2	DODAJ S. (KOS)	000 s2 / 011 s0 [04:00]	000 s0 / 010 s1 [04:00]
DODAJ Sidorela (KOS)	3	SIMIC T. (BIH)	34	KOSTANJEVEC A. (SLO)
SIMIC Tea (BIH)	4	KOSTANJEVEC A. (SLO)	000 s0 / 100 s0 [01:45]	
KOSTANJEVEC Arabela (SLO)	5	MACIS J. (ITA)	35	MACIS J. (ITA)
MACIS Jennifer (ITA)	6	GLAUNER H. (GER)	100 s2 / 000 s3 [08:59]	
GLAUNER Hannah (GER)	7	FINDRIK P. (CRO)	020 s0 / 000 s0 [00:45]	
SIMIC Andjela (SRB)	8	NEUMANN R. (ISR)	100 s1 / 000 s0 [01:16]	
FINDRIK Paula (CRO)				
KOVACS Reka (HUN)				
NEUMANN Raphael (ISR)				

POOL B

ROBINSON Lucy (GBR)	9	ROBINSON L. (GBR)	37	GUETH S. (GER)
GUETH Sarah (GER)	10	GUETH S. (GER)	000 s3 / 100 s1 [05:16]	
GUION Sofia (ITA)	11	KYRYLCHUK K. (UKR)	38	KYRYLCHUK K. (UKR)
TONKA Helena (AUT)	12	ZIVKOVIC V. (CRO)	011 s2 / 001 s1 [04:15]	
KYRYLCHUK Kseniia (UKR)	13	BONZANO G. (ITA)	39	BONZANO G. (ITA)
ZIVKOVIC Valentina (CRO)	14	SLOTH HANSEN A. (DEN)	000 s1 / 020 s0 [04:00]	
BONZANO Giulia (ITA)	15	CHIRON A. (MDA)	40	CHIRON A. (MDA)
KOLMAN Gili (ISR)	16	JOVANOVIC S. (SLO)	100 s0 / 000 s1 [01:32]	
SLOTH HANSEN Alice (DEN)				
CHIRON Alexandra (MDA)				
SUVEGES Fanni (HUN)				
JOVANOVIC Sara (SLO)				

POOL C

GRENIER Melody (CAN)	17	GRENIER M. (CAN)	41	GRENIER M. (CAN)
BERNABEI Alisia (ITA)	18	BERNABEI A. (ITA)	011 s0 / 000 s2 [04:00]	
MIKULANDRA Tena (CRO)	19	PAJERICH A. (HUN)	42	SAMEC N. (SLO)
PAJERICH Anna (HUN)	20	SAMEC N. (SLO)	001 s0 / 011 s0 [04:00]	
SAMEC Nusa (SLO)	21	MAMMADOVA A. (AZE)	43	MAMMADOVA A. (AZE)
MAMMADOVA Aysun (AZE)	22	MONNEY L. (SUI)	100 s0 / 001 s1 [03:05]	
MONNEY Lya (SUI)	23	ASHKENAZI Shay (ISR)	000 s0 / 020 s0 [00:44]	
MRDJA Elena (SRB)	24	LE BRASSEUR G. (FRA)	110 s1 / 010 s3 [05:14]	
ASHKENAZI Shay (ISR)				
SIMIC Mia (BIH)				
LE BRASSEUR Gabrielle (FRA)				

POOL D

CORDOVA Sofia (SWE)	25	CORDOVA S. (SWE)	45	CORDOVA S. (SWE)
STOJANOV Lenka (SRB)	26	STOJANOV L. (SRB)	100 s0 / 000 s1 [00:32]	
KELEMINOVIC Tara (CRO)	27	HASID D. (ISR)	46	CSERPAK F. (HUN)
HASID Daniella (ISR)	28	CSERPAK F. (HUN)	000 s0 / 100 s0 [00:08]	
TUERK Helin (AUT)	29	YEMELIANOVA Y. (UKR)	47	VADOVICOVA V. (SVK)
CSERPAK Fruzsina (HUN)	30	VADOVICOVA V. (SVK)	100 s0 / 000 s0 [00:42]	
YEMELIANOVA Yelyzaveta (UKR)	31	PAVLENCO E. (MDA)	48	LEMM E. (GER)
VADOVICOVA Vivien (SVK)	32	LEMM E. (GER)	100 s0 / 000 s0 [00:45]	
ESHTEL Carmel (ISR)				
DI LEONARDO Noemi (ITA)				
PAVLENCO Elizaveta (MDA)				
LEMM Emilia (GER)				

REPECHAGE

TEISANU T. (ROU)	61	VAS M. (HUN)	65	VAS M. (HUN)
VAS M. (HUN)		KOSTANJEVEC A. (SLO)	011 s0 / 000 s1 [04:00]	
SUVEGES F. (HUN)	62	SUVEGES F. (HUN)	66	BONZANO G. (ITA)
JOVANOVIC S. (SLO)		BONZANO G. (ITA)	000 s0 / 100 s1 [01:34]	
MONNEY L. (SUI)	63	MONNEY L. (SUI)	67	MONNEY L. (SUI)
STOJANOV L. (SRB)	64	STOJANOV L. (SRB)	68	CSERPAK F. (HUN)
		CSERPAK F. (HUN)	100 s0 / 000 s0 [00:00]	

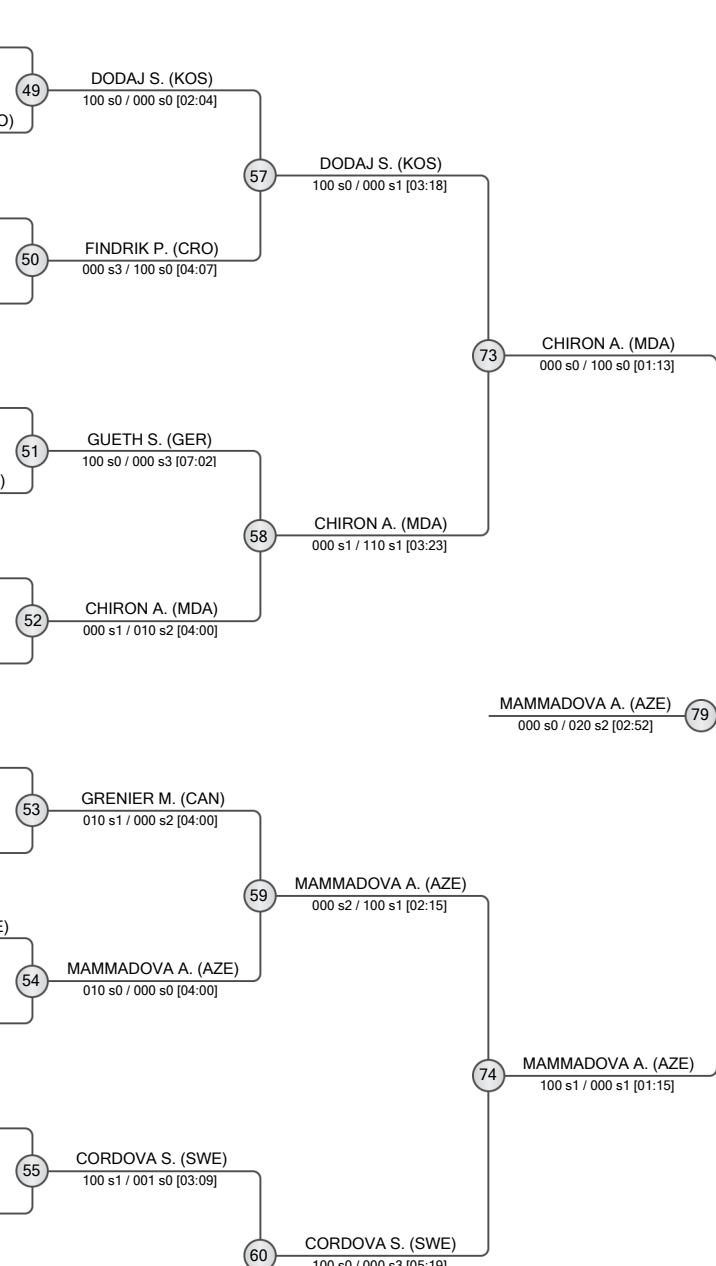

FINAL RESULTS		
1.	MAMMADOVA Aysun	AZE
2.	CHIRON Alexandra	MDA
3.	BONZANO Giulia	ITA
3.	GRENIER Melody	CAN
5.	CORDOVA Sofia	SWE
5.	DODAJ Sidorela	KOS
7.	VAS Mira	HUN
7.	PAVLENCO Elizaveta	MDA





Porec Millennium Team Cadet European Cup 2025

Croatia, Porec, 15-16 Mar 2025

-57 kg

Women (66)

POOL A

	VEINHANDL OBAID Haya	SLO	1	VEINHANDL OBAID H. (SLO)
	GIORDANO Valeria	ITA	2	GIORDANO V. (ITA)
	PALLAI Dora	HUN	3	PALLAI D. (HUN)
	ARIDON Ornella	FRA	4	ARIDON O. (FRA)
	ZIVKOVIC Tamara	SRB	5	ZIVKOVIC T. (SRB)
	RUSINOVA Yuliana	BUL	6	001 s2 / 000 s1 [04:00]
	VAZQUEZ FERNANDEZ Irene	ESP	6	VAZQUEZ FERNANDEZ I. (ESP)
	TOMESCU Yasmine	ROU	7	TOMESCU Y. (ROU)
	BARAC Patricija	CRO	8	BARAC P. (CRO)
	BOZSO Zita	HUN	9	BOZSO Z. (HUN)
	SHATTOCK Maisie	GBR	10	SHATTOCK M. (GBR)
	RUCHTI Noemi	SUI	11	RUCHTI N. (SUI)
	RACIC Ana Marija	CRO	12	RACIC A. (CRO)
	KYIALBEKOVA Aaisha	KGZ	13	KYIALBEKOVA A. (KGZ)
	POTOCKI Dora	CRO	14	POTOCKI D. (CRO)
	MEKAITON Shira	ISR	15	MEKAITON S. (ISR)
	MIKOTA Katharina	AUT	16	MIKOTA K. (AUT)

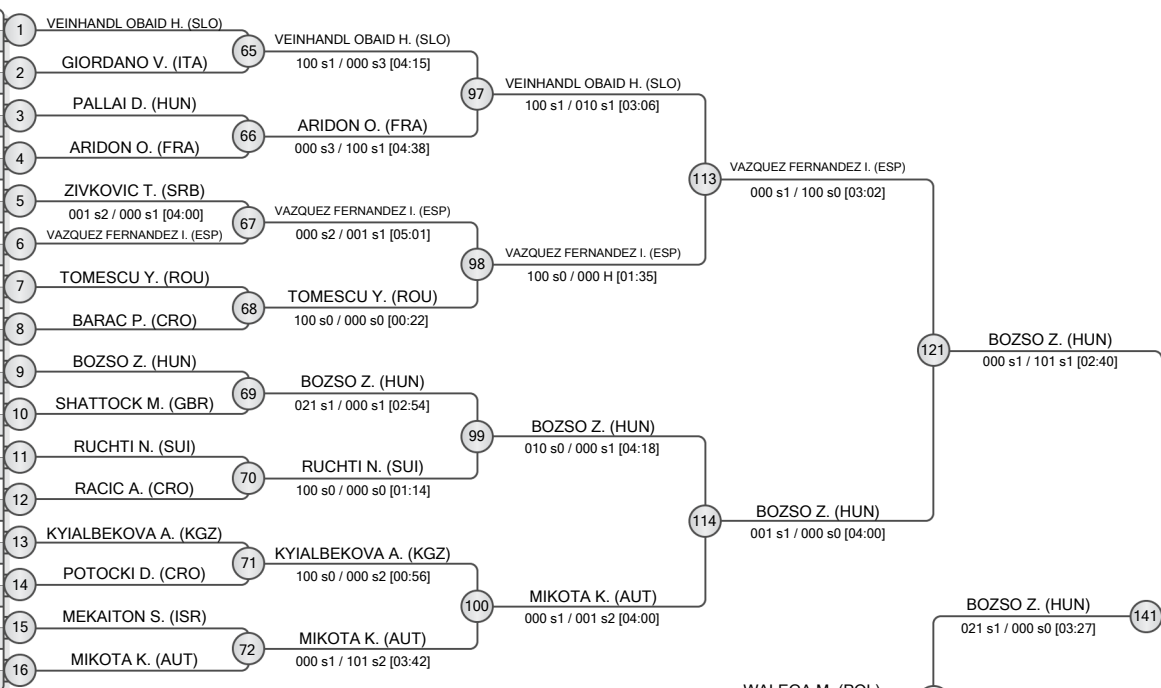

POOL B

	BARTYIK Iza	HUN	17	BARTYIK I. (HUN)
	TRAAVIK Asal	NOR	18	TRAAVIK A. (NOR)
	VALIYEVA Nazakat	AZE	19	VALIYEVA N. (AZE)
	BALABAN Sofiia	UKR	20	BALABAN S. (UKR)
	ROITBERG Emma	ITA	21	ROITBERG E. (ITA)
	VIDAK Matea	CRO	22	VIDAK M. (CRO)
	GIMENO PEREIRA Julia	ESP	23	GIMENO PEREIRA J. (ESP)
	BAUER Susanne	AUT	24	BAUER S. (AUT)
	MORUZZI Rachele	ITA	25	MORUZZI R. (ITA)
	GUZINA Vanja	MNE	26	GUZINA V. (MNE)
	BIKIC Karmen	CRO	27	BIKIC K. (CRO)
	NEAGU Isabela Ioana	ROU	28	NEAGU I. (ROU)
	CLARK Isabelle	SUI	29	CLARK I. (SUI)
	DJOKIC Elena	SRB	30	DJOKIC E. (SRB)
	MASTNAK Zarja	SLO	31	MASTNAK Z. (SLO)
	DANISOVA Ema	SVK	32	DANISOVA E. (SVK)

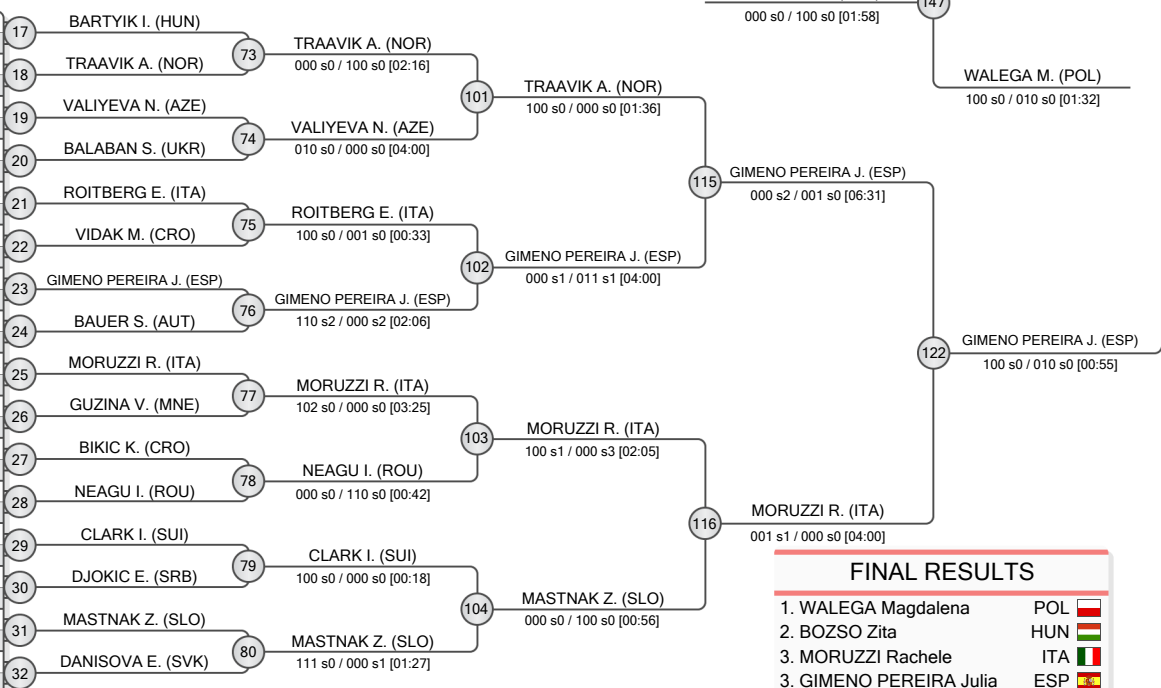

FINAL RESULTS		
1.	WALEGA Magdalena	POL
2.	BOZSO Zita	HUN
3.	MORUZZI Rachele	ITA
3.	GIMENO PEREIRA Julia	ESP
5.	PAVEN Amelia	ROU
5.	ZIJADE Enise	KOS
7.	RUCHTI Noemi	SUI
7.	LOZOVIUK Daria	UKR

REPECHAGE

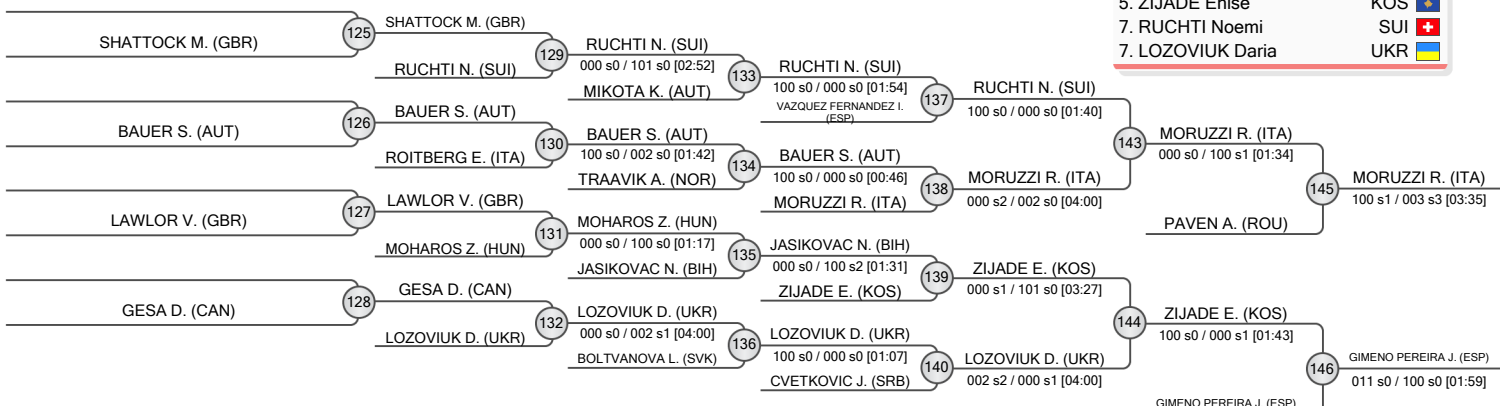



Porec Millennium Team Cadet European Cup 2025

Croatia, Porec, 15-16 Mar 2025

-63 kg

Women (47)

POOL A

1	TSURKAN Ilariia (UKR)	2	STAROVASNIK Timeja (SLO)
3	PRELCEC Tena (CRO)	4	IASEVOLI Emma (ITA)
5	SKILJEVIC Ana (BIH)	6	BARRIER MONTAGNON Lysandre (FRA)
7	PINTER Julia (HUN)	8	POPOVIC Kaja (CRO)

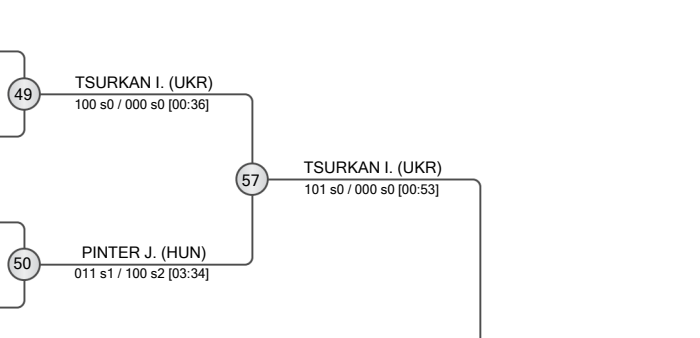

POOL B

9	FROSONI Giorgia (ITA)	10	JEAN Chloe (FRA)
11	SCHWARZBAUER Carina (AUT)	12	BJARNADOTTIR Helena (ISL)
13	THOMSON Maia (CAN)	14	ROEMMER A. (GER)
15	GLIGA Ana (ROU)	16	DIVON Maya (ISR)

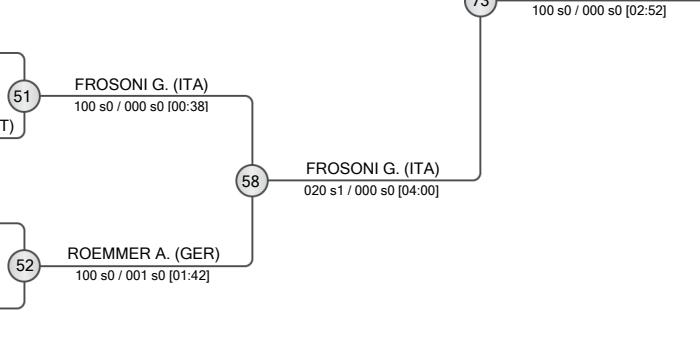

POOL C

17	WOZNICZKO Nadia (POL)	18	SCARSO Chiara (ITA)
19	TOROK Csenge (HUN)	20	MAIDANA Juana (ARG)
21	PAVLOVIC Nevena (SRB)	22	BACHLER Anna (AUT)
23	SAMOILIUK Diana (UKR)	24	BOZKURT Narin (GER)

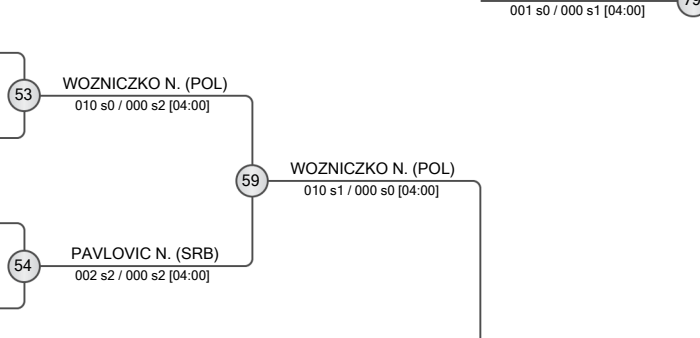

POOL D

25	DALMASSO Madeleine (FRA)	26	RAMA Bleona (AUT)
27	STOCK Luisa (GER)	28	PIGAT Elisa (ITA)
29	ANDRICH Nina (SRB)	30	RUSU Maria (MDA)
31	MATUSZEKOVA Paula (SVK)	32	MCGILL Bronach Mary (GBR)

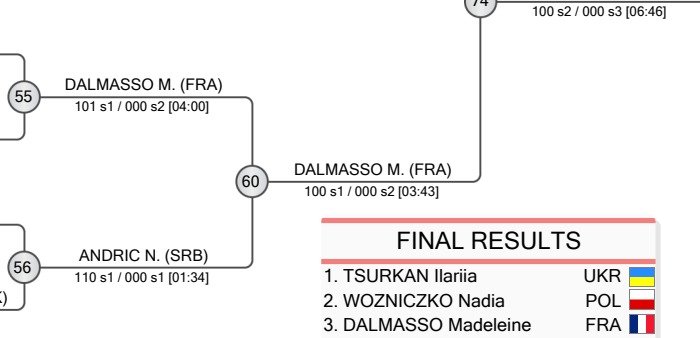

FINAL RESULTS		
1.	TSURKAN Ilariia	UKR
2.	WOZNICZKO Nadia	POL
3.	DALMASSO Madeleine	FRA
4.	FROSONI Giorgia	ITA
5.	JEAN Chloe	FRA
6.	ANDRICH Nina	SRB
7.	PINTER Julia	HUN
8.	SIMANIC Ana	BIH

REPECHAGE

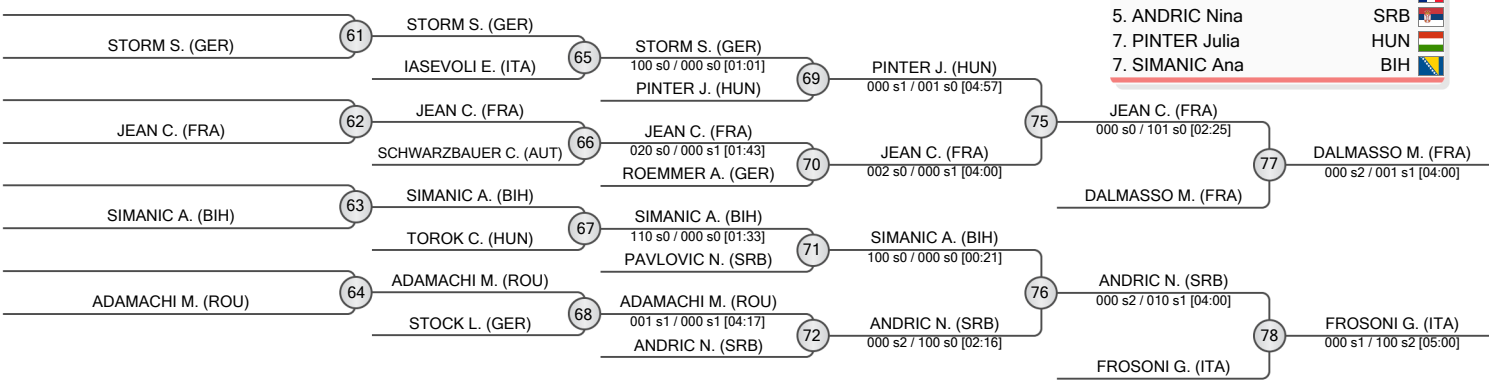



Porec Millennium Team Cadet European Cup 2025

Croatia, Porec, 15-16 Mar 2025

-70 kg

Women (36)

POOL A

	MCHENRY Hannah	AUS	1	MCHENRY H. (AUS)				
	FEHER Zara	ROU	2	FEHER Z. (ROU)	33	FEHER Z. (ROU)	000 s3 / 100 s2 [05:11]	
	ZELL Amit	ISR		100 s1 / 000 s1 [03:10]				
	GRASSI Giorgia	ITA	3	GRASSI G. (ITA)		49	GRASSI G. (ITA)	000 s3 / 100 s2 [05:12]
	SPOLJAR Kaira Matijana	CRO	4	SPOLJAR K. (CRO)	34	GRASSI G. (ITA)	020 s0 / 000 s1 [02:09]	
	ILIC Sara	SRB	5	ILIC S. (SRB)				
	GLAVINA Nika	CRO	6	GLAVINA N. (CRO)	35	ILIC S. (SRB)	100 s0 / 000 s0 [00:45]	
	FILZWIESER Emma	AUT	7	FILZWIESER E. (AUT)		50	FILZWIESER E. (AUT)	001 s0 / 110 s2 [04:00]
	BENBRAHIM Amelia	FRA	8	BENBRAHIM A. (FRA)	36	FILZWIESER E. (AUT)	001 s2 / 000 s1 [04:00]	

POOL B

	BESKER Ana	CRO	9	BESKER A. (CRO)				
	MARCHIO' Claudia	ITA	10	MARCHIO' C. (ITA)	37	BESKER A. (CRO)	100 s0 / 000 s0 [00:20]	
	SANCHEZ VALLE Andrea	ESP	11	SANCHEZ VALLE A. (ESP)		51	BESKER A. (CRO)	100 s0 / 000 s2 [05:43]
	BAYRAMLI Malak	AZE		100 s0 / 000 s1 [01:24]				
	DOGSA Lara	SLO	12	DOGSA L. (SLO)	38	SANCHEZ VALLE A. (ESP)	103 s1 / 000 s3 [02:57]	
	THIBAUT Charlie	CAN	13	THIBAUT C. (CAN)				
	TERLETSKA Anna	UKR	14	TERLETSKA A. (UKR)	39	THIBAUT C. (CAN)	110 s0 / 000 s1 [02:20]	
	RABL Mavie	AUT	15	RABL M. (AUT)		52	THIBAUT C. (CAN)	100 s0 / 000 s0 [00:39]
	JELCIC Ani	CRO	16	JELCIC A. (CRO)	40	RABL M. (AUT)	020 s0 / 000 s0 [01:48]	

POOL C

	ZYS Roksana	POL	17	ZYS R. (POL)				
	ZAGO Kiara	CRO	18	PAVIC N. (AUT)	41	ZYS R. (POL)	111 s0 / 000 s0 [01:56]	
	PAVIC Natasa	AUT		000 s0 / 021 s1 [01:52]		53	ZYS R. (POL)	100 s0 / 000 s0 [01:04]
	JALILLI Fidan	AZE	19	JALILLI F. (AZE)				
	VLAHOVIC Teodora	MNE	20	VLAHOVIC T. (MNE)	42	JALILLI F. (AZE)	100 s0 / 000 s3 [04:33]	
	HUDIKA Vita	CRO	21	HUDIKA V. (CRO)				
	DOVHUN Yana	UKR	22	DOVHUN Y. (UKR)	43	HUDIKA V. (CRO)	020 s1 / 000 s0 [01:24]	
	LEFRANCOIS Kiara	FRA	23	LEFRANCOIS K. (FRA)		54	HUDIKA V. (CRO)	100 s0 / 000 s0 [02:18]
	BAUMANN Rosalie	AUT	24	BAUMANN R. (AUT)	44	LEFRANCOIS K. (FRA)	001 s0 / 000 s2 [04:17]	

POOL D

	BENKOVA Diana	POL	25	BENKOVA D. (POL)				
	MISIC Antonia	CRO	26	VIGNA P. (ITA)	45	BENKOVA D. (POL)	020 s0 / 000 s0 [00:22]	
	VIGNA Petra	ITA		001 s2 / 020 s0 [02:34]		55	HLADNIK N. (SLO)	000 s1 / 101 s0 [02:57]
	HLADNIK Neza	SLO	27	HLADNIK N. (SLO)				
	DUMINICA Madina	MDA	28	DUMINICA M. (MDA)	46	HLADNIK N. (SLO)	100 s0 / 000 s1 [01:14]	
	WOEGERER Selina	AUT	29	WOEGERER S. (AUT)				
	BOB Isabel	ROU	30	BOB I. (ROU)	47	BOB I. (ROU)	000 s0 / 101 s0 [01:40]	
	PUPKO Arielle	ISR	31	PUPKO A. (ISR)		56	BOB I. (ROU)	100 s0 / 000 s0 [00:30]
	BRALIC Sara	CRO	32	BRALIC S. (CRO)	48	PUPKO A. (ISR)	021 s0 / 000 s0 [00:58]	

REPECHAGE

	SPOLJAR K. (CRO)	61	SPOLJAR K. (CRO)					
			FEHER Z. (ROU)	65	FEHER Z. (ROU)	69	FEHER Z. (ROU)	100 s0 / 000 s3 [02:03]
			FEHER Z. (ROU)					
	MARCHIO' C. (ITA)	62	MARCHIO' C. (ITA)					
			SANCHEZ VALLE A. (ESP)	66	SANCHEZ VALLE A. (ESP)	70	SANCHEZ VALLE A. (ESP)	010 s0 / 000 s0 [04:00]
			SANCHEZ VALLE A. (ESP)					
	PAVIC N. (AUT)	63	PAVIC N. (AUT)					
			JALILLI F. (AZE)	67	JALILLI F. (AZE)			
			JALILLI F. (AZE)			71	HUDIKA V. (CRO)	000 s1 / 020 s0 [01:25]
			HUDIKA V. (CRO)					
	DUMINICA M. (MDA)	64	DUMINICA M. (MDA)					
			BENKOVA D. (POL)	68	BENKOVA D. (POL)	72	BOB I. (ROU)	000 s0 / 100 s0 [01:15]
			BENKOVA D. (POL)					

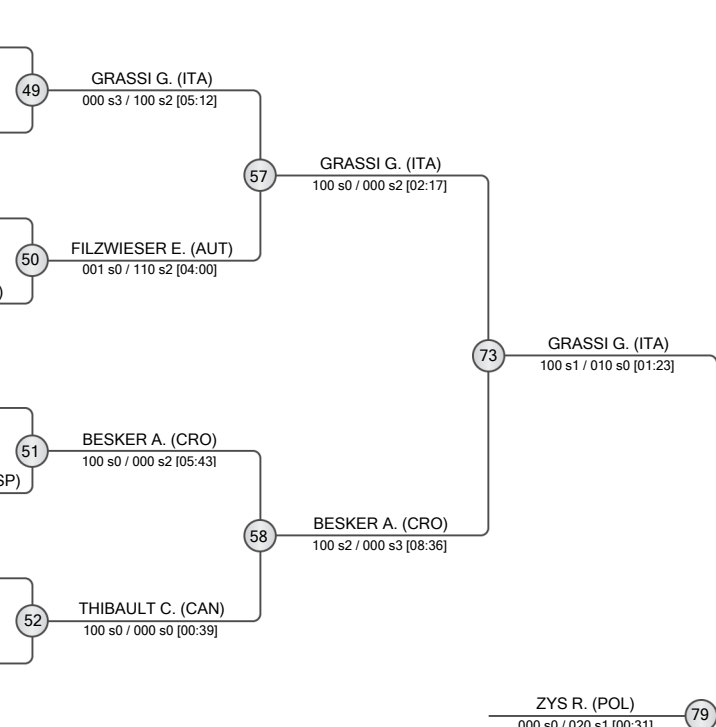

FINAL RESULTS		
1.	ZYS Roksana	POL
2.	GRASSI Giorgia	ITA
3.	HLADNIK Neza	SLO
3.	BESKER Ana	CRO
5.	FEHER Zara	ROU
5.	BOB Isabel	ROU
7.	SANCHEZ VALLE Andrea	ESP
7.	HUDIKA Vita	CRO





Porec Millennium Team Cadet European Cup 2025

Croatia, Porec, 15-16 Mar 2025

+ 70 kg

Women (20)

POOL A

	TROKA Julia	POL
	MAGASSA FOFANA Sogona	ESP
	PALERMO Elisa	ITA
	NIKETIC Leona	CRO
	SAMOLIUK Anna	UKR

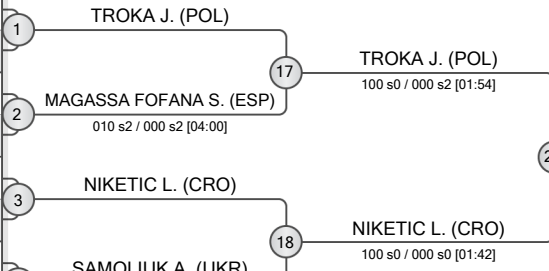

POOL B

	RADAKOVIC Milica	SRB
	SKRABAN Lana	SLO
	MILANOVIC Lucija	CRO
	HOELLWART Michaela	AUT
	BORRHOMEE Maelle	FRA

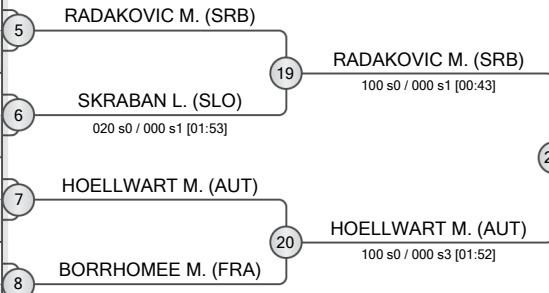

POOL C

	ZAREBA Nikola	POL
	DJEDIAT Imen	SUI
	COULIBALY TOURE Ballalo	ESP
	SACKO Astan	FRA
	ZENUNI Sara	ITA

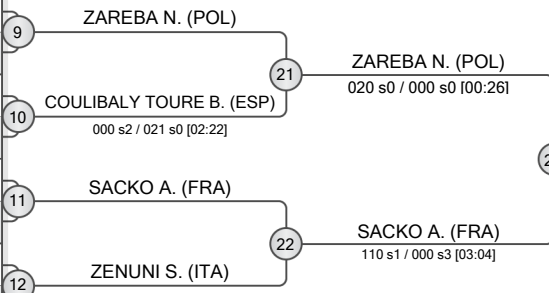

POOL D

	SCHIAVON Carlotta	ITA
	JURAK Jazmin	HUN
	AJDUKOVIC Antea	CRO
	MRAKOVIC Una	SRB
	BAHMET Kira	UKR

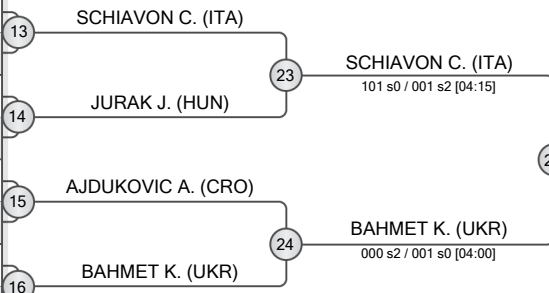

REPECHAGE

MAGASSA FOFANA S. (ESP) (29)	MAGASSA FOFANA S. (ESP) (33)
BORRHOMEE M. (FRA) (30)	RADAKOVIC M. (SRB) (34)
ZENUNI S. (ITA) (31)	ZAREBA N. (POL) (35)
MRAKOVIC U. (SRB) (32)	AJDUKOVIC A. (CRO) (36)
AJDUKOVIC A. (CRO) (32)	AJDUKOVIC A. (CRO) (36)

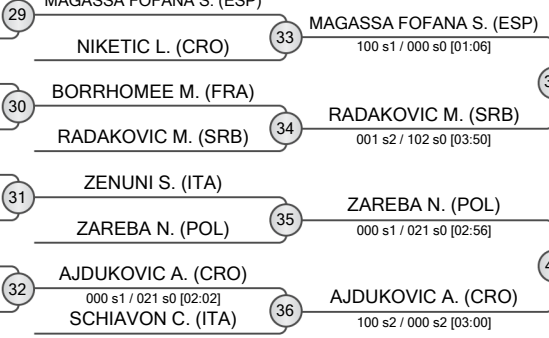

FINAL RESULTS

- TROKA Julia (POL)
- SACKO Astan (FRA)
- RADAKOVIC Milica (SRB)
- AJDUKOVIC Antea (CRO)
- BAHMET Kira (UKR)
- HOELLWART Michaela (AUT)
- MAGASSA FOFANA Sogona (ESP)
- ZAREBA Nikola (POL)

