



Event Report

European Hopes Cup Riga 2024, 16-17 Nov 2024

Event Report

200 competitors from 16 nations

140 Men

60 Women

70.00%

30.00%

-38 kg	-42 kg	-46 kg	-50 kg	-55 kg	-60 kg	-66 kg	-73 kg	+73 kg	Men
12	19	18	18	20	21	11	9	12	140

-36 kg	-40 kg	-44 kg	-48 kg	-52 kg	-57 kg	-63 kg	-70 kg	+70 kg	Women
0	3	5	8	10	10	12	7	5	60

Continent	AJU	JUA	EJU	PJC	PJC	Total
Nations			16			16
Competitors			200			200

Schedule		
Date	16 Nov	17 Nov
Start	10:00	10:00
End	15:00	15:00
Finals start	15:00	15:00
Finals end	16:45	16:40



European Hopes Cup Riga 2024

Latvia, Riga, 16-17 Nov 2024

U15 F
Final results

-36 kg		

-40 kg		
1	GRACOVA Dominika	CZE
2	ORTMANOVA Ludmila	CZE

-44 kg		
1	MAVROVA Sofia	BUL
2	GIGILASHVILI Tatia	GEO
3	SAKLAURE Lauma Liva	LAT
4	EIMUTYTE Goda	LTU

-48 kg		
1	MERKVILADZE Salome	GEO
2	PIELOCH Oliwia	POL
3	PJATECKA Varvara	LAT
3	SIMIC Tea	BIH
5	MOREIRA Soukayna	LUX
5	CZERWINSKA-KOWAR Karina	POL

-52 kg		
1	GULBANI Tinatin	GEO
2	CIBULSKAITE RUSNE	LTU
3	GAIGALAITA MONIKA	LTU
3	GULIASHVILI Mariam	GEO
5	BUZINA Anastasia	EST
5	MARKOVA Maraya	BUL

-57 kg		
1	SABIASHVILI Nene	GEO
2	AMICHAY ALMA	ISR
3	SMIDOVA Aneta	CZE
3	KHARAZISHVILI Ketevan	GEO
5	KAZRADZE Katrina Anna	LAT
5	LASS Cara	EST
7	JARVE Mirjam	EST

-63 kg		
1	OLEV Heleri	EST
2	SOPAITE IRUNA	LTU
3	JUSEVICIUTE Radvile	LTU
3	PONOMARENKO MARIIA Mariia	GER
5	UKASA Agnese	LAT
5	GLUHOVSKA Nikola	LAT
7	GAZDIKOVA Marketa	CZE
7	DAVADZE Liza	GEO

-70 kg		
1	JONUSAITE Ieva	LTU
2	GHVALADZE Maia	GEO
3	CUBRILO Tamara	SRB
3	BILKOVA Eliska	CZE
5	BLODONE MADARA	LAT



European Hopes Cup Riga 2024

Latvia, Riga, 16-17 Nov 2024

U15 F
Final results

+70 kg		
1	SHALAMBERIDZE Lika	GEO
2	ZAHHAROVA ANASTASIA	EST
3	POZERAITE Justina	LTU
4	DYBA Alicja	POL
5	KHOSROSHVILI Magda	GEO



European Hopes Cup Riga 2024

Latvia, Riga, 16-17 Nov 2024

U15 M
Final results

-38 kg		
1	SEGUIN Louie	GBR
2	NESVIETOV SVIATOSLAV	UKR
3	KISIS Ricards	LAT
3	TANASI SANDO	LAT
5	BURBA Karol	POL
5	FALELASHVILI Luka	GEO
7	WALKER Cuthbert	GBR
7	PEKKI Stefan	FIN

-42 kg		
1	TSURTSUMIA Andria	GEO
2	JAVAKHISHVILI Giorgi	GEO
3	STURME Dementijs	LAT
3	CHKADUA Beqa	GEO
5	NAVICKAS Navickas	LTU
5	ZUBETS Rodion	EST
7	SINAGINS NILS	LAT
7	OLSAUSKAS Nojus	LTU

-46 kg		
1	MICIULEVICIUS Gilius	LTU
2	SELUHINS Ildars	LAT
3	DOBROVOLSKIS Mantas	LTU
3	MIGHRIJANASHVILI Otar	GEO
5	MICIULEVICIUS Gustas	LTU
5	PUSKAS Michael	GBR
7	LELOTKO Dmitrijs	LAT
7	BANGNOWSKI Tun	LUX

-50 kg		
1	CERVINSKIS BOGDANS	LAT
2	ZVANERS Deivs	LAT
3	MOR BARAK OMER	ISR
3	AAL Mattias	EST
5	AZARUMYAN Aren	EST
5	YASSUR itay	ISR
7	OJA Jan Rasmus	EST
7	TOMBERG Karl Kaspar	EST

-55 kg		
1	LAZORKINS Timofejs	LAT
2	BIRNITIS Janis Jakobs	LAT
3	APOSTOLOV Mihail	BUL
3	ROBBINS Zachary	GBR
5	TOOMPARK Taavi	EST
5	GHOUGHADZE Irakli	GEO
7	ZUBAVICIUS Tadas	LTU
7	TAGIJEVS Farids	LAT

-60 kg		
1	LESNIEKS Nikita	LAT
2	VAELI Christyan	EST
3	PILECKAS Dovydas	LTU
3	ZAGORSKIS Nikita	LAT
5	SAMKHARADZE Lazare	GEO
5	KLACHKOVSKIS Miroslavs	LAT
7	BEATTIE-LEWIS Tony	GBR
7	POMASKOVSKIS Matiss	LAT

-66 kg		
1	NIKOLCHEV Ivan	BUL
2	PAPUNASHVILI Andro	GEO
3	KRIGERS Reinis	LAT
3	TOOMEL Joosep	EST
5	MALUSEVS Bogdans	LAT
5	STOYKOV Georgi	BUL
7	GHALADZE Davit	GEO
7	HORONKO Aleksejs	LAT

-73 kg		
1	CHARENKA KAJUS	LTU
2	KALYNYIAK Oleh	UKR
3	ALIKHANOV Amir	EST
3	KAROLS MARJANS	LAT
5	DOBRZANSKIS Renats	LAT
5	VOLODENOKS Mihails	LAT



European Hopes Cup Riga 2024

Latvia, Riga, 16-17 Nov 2024

U15 M
Final results

+73 kg			
1	PATEJENOKS Alekss	LAT	
2	SIDLAUSKAS JOKUBAS	LTU	
3	BRUNNER Jan	CZE	
3	PODKUJKO Igors	LAT	
5	RAGS Ostins	LAT	
5	LIPPUS Hubert	EST	
7	SIKULJAK Relja	BIH	
7	ZUKS Glebs	LAT	



Medals

European Hopes Cup Riga 2024, 16-17 Nov 2024

Medals

#	Nation	1. Place	2. Place	3. Place	4. Place	5. Place	7. Place
1.	GEO Georgia	5	4	4		4	2
2.	LAT Latvia	4	3	9		9	6
3.	LTU Lithuania	3	3	5	1	2	2
4.	BUL Bulgaria	2		1		2	
5.	EST Estonia	1	2	3		6	3
6.	CZE Czechia	1	1	3			1
7.	GBR Great Britain	1		1		1	2
8.	UKR Ukraine		2				
9.	ISR Israel		1	1		1	
10.	POL Poland		1		1	2	
11.	BIH Bosnia and Herzegovina			1			1
12.	GER Germany			1			
12.	SRB Serbia			1			
14.	LUX Luxembourg					1	1
15.	FIN Finland						1

Official person:



Statistics

European Hopes Cup Riga 2024, 16-17 Nov 2024

Statistics

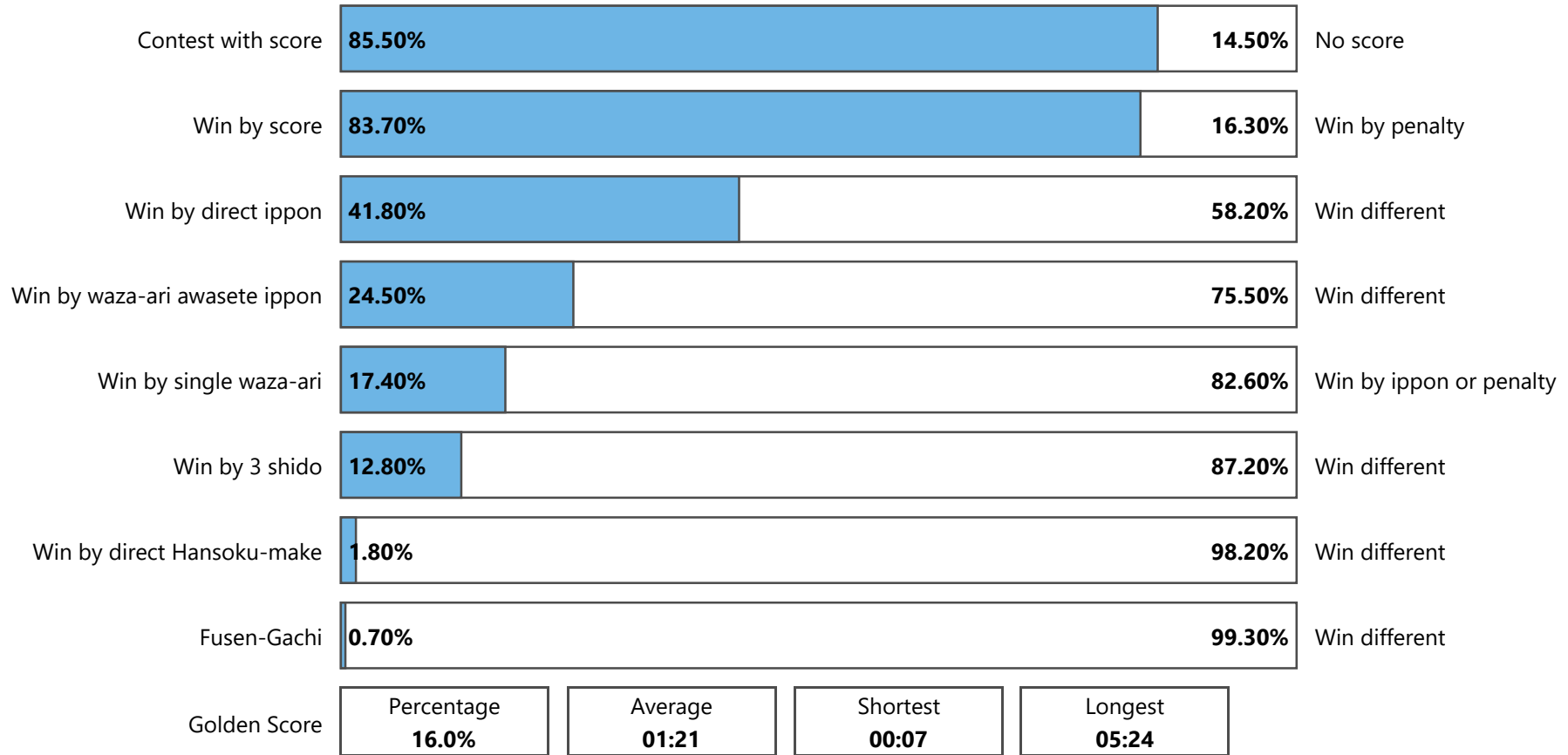



Statistics

European Hopes Cup Riga 2024, 16-17 Nov 2024

Statistics

	-38	-42	-46	-50	-55	-60	-66	-73	+73	M	-36	-40	-44	-48	-52	-57	-63	-70	+70	W	Total
Competitors	12	19	18	18	20	21	11	9	12	140		3	5	8	10	10	12	7	5	60	200
Contests	16	28	25	25	27	30	15	12	18	196		3	10	11	14	14	15	9	10	86	282
Contests with score	13	22	19	22	23	25	15	10	17	166		2	8	10	12	13	15	8	7	75	241
Contests with score %	81.3%	78.6%	76%	88%	85.2%	83.3%	100%	83.3%	94.4%	84.7	0%	66.7%	80%	90.9%	85.7%	92.9%	100%	88.9%	70%	87.2	85.5%
Wins by Score	13	22	19	21	23	24	15	10	16	163		1	8	10	12	13	15	7	7	73	236
Wins by Score %	81.3%	78.6%	76%	84%	85.2%	80%	100%	83.3%	88.9%	83.2	0%	33.3%	80%	90.9%	85.7%	92.9%	100%	77.8%	70%	84.9	83.7%
Wins by direct Ippon	4	7	10	12	13	10	11	6	8	81			5	4	5	8	8	3	4	37	118
Wins by direct Ippon %	25%	25%	40%	48%	48.1%	33.3%	73.3%	50%	44.4%	41.3	0%	0%	50%	36.4%	35.7%	57.1%	53.3%	33.3%	40%	43.0	41.8%
Wins by Waza-ari Awasete Ippon	6	9	4	2	6	11	3	2	6	49		1	2	2	4	2	4	3	2	20	69
Wins by Waza-ari Awasete Ippon %	37.5%	32.1%	16%	8%	22.2%	36.7%	20%	16.7%	33.3%	25%	0%	33.3%	20%	18.2%	28.6%	14.3%	26.7%	33.3%	20%	23.3	24.5%
Wins by single Waza-ari	3	6	5	7	4	3	1	2	2	33			1	4	3	3	3	1	1	16	49
Wins by single Waza-ari %	18.8%	21.4%	20%	28%	14.8%	10%	6.7%	16.7%	11.1%	16.8	0%	0%	10%	36.4%	21.4%	21.4%	20%	11.1%	10%	18.6	17.4%
Wins by 3 Shido for opponent	2	6	5	3	3	3		2	2	26		1	1	1	1	1		2	3	10	36
Wins by 3 Shido for opponent %	12.5%	21.4%	20%	12%	11.1%	10%	0%	16.7%	11.1%	13.3	0%	33.3%	10%	9.1%	7.1%	7.1%	0%	22.2%	30%	11.6	12.8%
Direct Hansoku-make	1			1	1	1				4		1								1	5
Wins by direct Hansoku-make %	6.3%	0%	0%	4%	3.7%	3.3%	0%	0%	0%	2.0%	0%	33.3%	0%	0%	0%	0%	0%	0%	0%	1.2%	1.8%
Fusen-gachi													1		1					2	2
Fusen-gachi %	0%	0%	0%	0%	0%	0%	0%	0%	0%	0%	0%	0%	10%	0%	7.1%	0%	0%	0%	0%	2.3%	0.7%
All positive Scores (Waza-ari + direct Ippon)	19	34	29	32	35	38	21	16	26	250		3	11	13	16	17	22	12	11	105	355
Average Scores per contests	1.2	1.2	1.2	1.3	1.3	1.3	1.4	1.3	1.4	1.29		1	1.1	1.2	1.1	1.2	1.5	1.3	1.1	1.06	1.17
All penalties (Shido + HSK)	22	46	34	44	36	36	9	23	18	268		6	9	15	16	19	18	15	24	122	390
Average penalty per contest	1.4	1.6	1.4	1.8	1.3	1.2	0.6	1.9	1	1.36		2	0.9	1.4	1.1	1.4	1.2	1.7	2.4	1.34	1.35
Golden Score	4	9	5	3	4	5	3	3		36			1	1	3	1	2	1		9	45
Golden Score %	25%	32.1%	20%	12%	14.8%	16.7%	20%	25%	0%	18.4	0%	0%	10%	9.1%	21.4%	7.1%	13.3%	11.1%	0%	10.5	16.0%
Osae-komi	2	11	15	12	1	4	10	5	3	63			6	5	4	10	10	3	6	44	107
Osae-komi %	13%	39%	60%	48%	4%	13%	67%	42%	17%	32.1	0%	0%	60%	45%	29%	71%	67%	33%	60%	51.2	37.9%
Wins by Penalty	3	6	5	4	4	4		2	2	30		2	1	1	1	1		2	3	11	41



Nations Overview

European Hopes Cup Riga 2024, 16-17 Nov 2024

Nations

Overview

			-38	-42	-46	-50	-55	-60	-66	-73	+73	M	-36	-40	-44	-48	-52	-57	-63	-70	+70	W	Total	D		
1.		BIH	Bosnia and Hercegovina	0	0	0	0	0	0	0	0	1	1	0	0	0	1	0	0	0	0	0	0	1	2	1
2.		BUL	Bulgaria	0	1	0	0	1	1	2	0	0	5	0	0	1	0	1	1	0	0	0	0	3	8	3
3.		CZE	Czechia	0	0	0	2	1	0	0	0	1	4	0	2	0	0	1	1	2	1	0	0	7	11	6
4.		EST	Estonia	0	3	1	5	2	4	1	2	1	19	0	0	0	0	1	2	1	0	1	0	5	24	4
5.		FIN	Finland	1	0	0	0	0	0	0	0	0	1	0	0	0	0	0	0	0	0	0	0	0	1	0
6.		GBR	Great Britain	2	1	2	1	1	3	0	0	0	10	0	0	1	0	0	0	0	0	0	0	1	11	6
7.		GEO	Georgia	1	3	1	0	1	1	3	0	1	11	0	0	1	1	2	3	1	1	2	0	11	22	5
8.		GER	Germany	0	1	0	0	0	0	0	0	0	1	0	0	0	0	0	0	1	0	0	0	1	2	2
9.		ISR	Israel	1	0	2	2	2	2	0	0	0	9	0	0	0	0	0	1	0	0	0	0	1	10	3
10.		LAT	Latvia	5	5	7	5	10	6	5	4	7	54	0	0	1	2	2	1	3	2	0	0	11	65	23
11.		LTU	Lithuania	0	4	4	2	1	1	0	2	1	15	0	0	1	0	3	1	3	2	1	0	11	26	8
12.		LUX	Luxembourg	0	0	1	0	1	1	0	0	0	3	0	0	0	1	0	0	0	0	0	0	1	4	1
13.		POL	Poland	1	1	0	1	0	1	0	0	0	4	0	0	0	2	0	0	0	0	1	0	3	7	2
14.		SRB	Serbia	0	0	0	0	0	0	0	0	0	0	0	1	0	1	0	0	0	1	0	0	3	3	1
15.		TUR	Turkey	0	0	0	0	0	0	0	0	0	0	0	0	0	0	0	0	1	0	0	0	1	1	1
16.		UKR	Ukraine	1	0	0	0	0	1	0	1	0	3	0	0	0	0	0	0	0	0	0	0	0	3	0
				12	19	18	18	20	21	11	9	12	140	0	3	5	8	10	10	12	7	5	60	200	66	



European Hopes Cup Riga 2024

Latvia, Riga, 16-17 Nov 2024

-38 kg

U15 M (12)

POOL A

	PRIMOR AMIT	ISR
	KISIS Ricards	LAT
	SEGUIN Louie	GBR

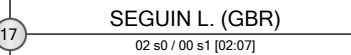
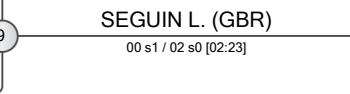
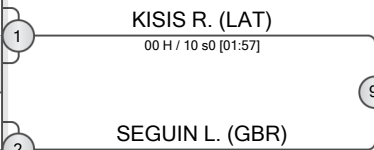

POOL B

	SAVINS Mastins	LAT
	WALKER Cuthbert	GBR
	TANASI SANDO	LAT

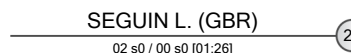
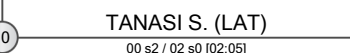
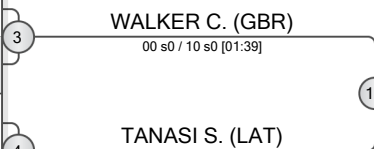

POOL C

	NIKOLAJEV Sandis	LAT
	FALELASHVILI Luka	GEO
	NESVIETOV SVIATOSLAV	UKR

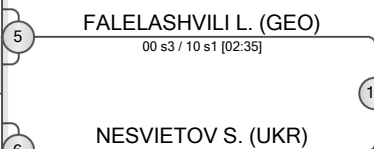

POOL D

	PETROVSKIS TOMAS	LAT
	BURBA Karol	POL
	PEKKI Stefan	FIN

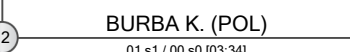
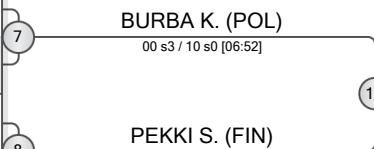

FINAL RESULTS		
1.	SEGUIN Louie	GBR
2.	NESVIETOV SVIATOSLAV	UKR
3.	KISIS Ricards	LAT
3.	TANASI SANDO	LAT
5.	BURBA Karol	POL
5.	FALELASHVILI Luka	GEO
7.	WALKER Cuthbert	GBR
7.	PEKKI Stefan	FIN

REPECHAGE

KISIS R. (LAT)	13
WALKER C. (GBR)	14
FALELASHVILI L. (GEO)	15
PETROVSKIS T. (LAT)	16
PEKKI S. (FIN)	16

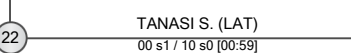
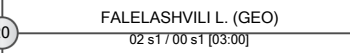
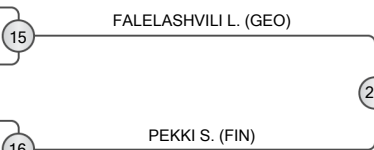
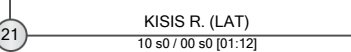
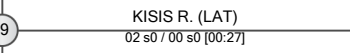
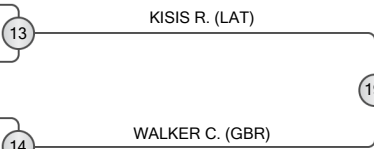



European Hopes Cup Riga 2024

Latvia, Riga, 16-17 Nov 2024

-42 kg

U15 M (19)

POOL A

	JAVAKHISHVILI Giorgi	GEO
	MAMETYEY Roman	GER
	JASAITIS Rokas	LTU
	SINAGINS NILS	LAT
	PAKULA Grigorijs	LAT

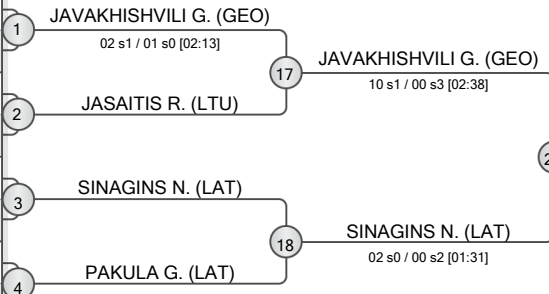

POOL B

	SAAR Kou Lennart	EST
	KALKA Szymon	POL
	SIUTILAS Emilis	LTU
	CHKADUA Beqa	GEO
	STURME Dementijs	LAT

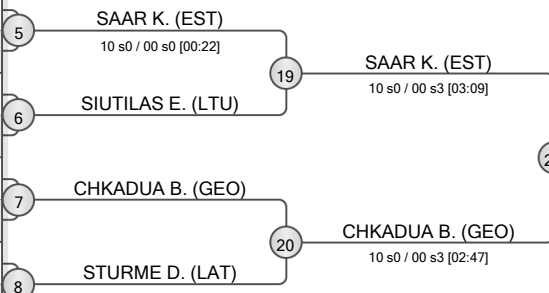

POOL C

	TRISBERG Ravo	EST
	TSURTSUMIA Andria	GEO
	WALKER Harry	GBR
	ZUBETS Rodion	EST

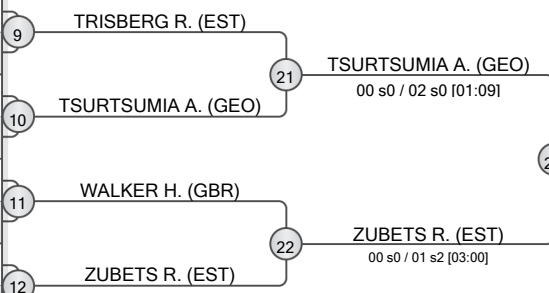

POOL D

	BRAHA Oles	LAT
	TUULS Aleksandrs	LAT
	NAVICKAS Navickas	LTU
	OLSAUSKAS Nojus	LTU
	ANTONIY Dimitrov	BUL

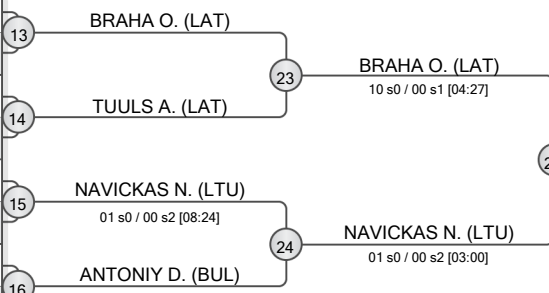

REPECHAGE

MAMETYEY R. (GER)	29	MAMETYEY R. (GER)	33	SINAGINS N. (LAT)
JASAITIS R. (LTU)		SINAGINS N. (LAT)		
STURME D. (LAT)	30	STURME D. (LAT)	34	STURME D. (LAT)
TRISBERG R. (EST)	31	TRISBERG R. (EST)	35	ZUBETS R. (EST)
OLSAUSKAS N. (LTU)		ZUBETS R. (EST)		
ANTONIY D. (BUL)	32	OLSAUSKAS N. (LTU)	36	OLSAUSKAS N. (LTU)
		BRAHA O. (LAT)		

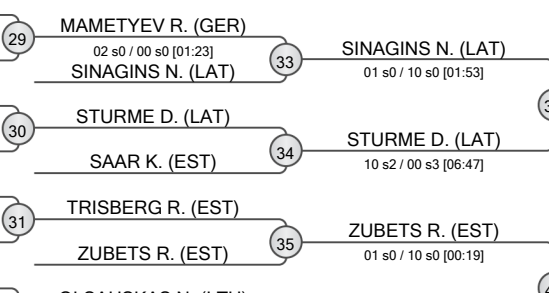

FINAL RESULTS	
1.	TSURTSUMIA Andria GEO
2.	JAVAKHISHVILI Giorgi GEO
3.	STURME Dementijs LAT
3.	CHKADUA Beqa GEO
5.	NAVICKAS Navickas LTU
5.	ZUBETS Rodion EST
7.	SINAGINS NILS LAT
7.	OLSAUSKAS Nojus LTU





European Hopes Cup Riga 2024

Latvia, Riga, 16-17 Nov 2024

-46 kg

U15 M (18)

POOL A

	LELOTKO Dmitrijs	LAT	1	LELOTKO D. (LAT)
	OKOMANS ARTJOMS	LAT	2	OKOMANS A. (LAT)
	MICIULEVICIUS Gilius	LTU	2	MICIULEVICIUS G. (LTU)
	REINSALU Markus	LAT	3	REINSALU M. (LAT)
	CHURCH Isaac	GBR	4	CHURCH I. (GBR)

POOL B

	DOBROVOLSIS Mantas	LTU	5	DOBROVOLSIS M. (LTU)
	MIGHRIJANASHVILI Otar	GEO	6	MIGHRIJANASHVILI O. (GEO)
	BLUM yonatan	ISR	7	BLUM y. (ISR)
	PETERSONS Patriks	LAT	8	PETERSONS P. (LAT)

POOL C

	MAULS Niks	LAT	9	MAULS N. (LAT)
	CIBULSKAS EINORAS	LTU	10	CIBULSKAS E. (LTU)
	PUSKAS Michael	GBR	11	PUSKAS M. (GBR)
	NEFJODOVS TAISSON	LAT	12	NEFJODOVS T. (LAT)
	MICIULEVICIUS Gustas	LTU	12	MICIULEVICIUS G. (LTU)

POOL D

	SELUHINS Ildars	LAT	13	SELUHINS I. (LAT)
	BLUM ido	ISR	14	BLUM i. (ISR)
	PINDING Robert	EST	15	PINDING R. (EST)
	BANGNOWSKI Tun	LUX	16	BANGNOWSKI T. (LUX)

REPECHAGE

LELOTKO D. (LAT)	29	LELOTKO D. (LAT)	33	LELOTKO D. (LAT)
REINSALU M. (LAT)	30	REINSALU M. (LAT)	34	REINSALU M. (LAT)
DOBROVOLSIS M. (LTU)	31	DOBROVOLSIS M. (LTU)	35	DOBROVOLSIS M. (LTU)
PETERSONS P. (LAT)	32	PETERSONS P. (LAT)	36	PETERSONS P. (LAT)
PUSKAS M. (GBR)	33	PUSKAS M. (GBR)	37	PUSKAS M. (GBR)
CIBULSKAS E. (LTU)	34	CIBULSKAS E. (LTU)	38	CIBULSKAS E. (LTU)
BLUM i. (ISR)	35	BLUM i. (ISR)	39	BLUM i. (ISR)
BANGNOWSKI T. (LUX)	36	BANGNOWSKI T. (LUX)	40	BANGNOWSKI T. (LUX)

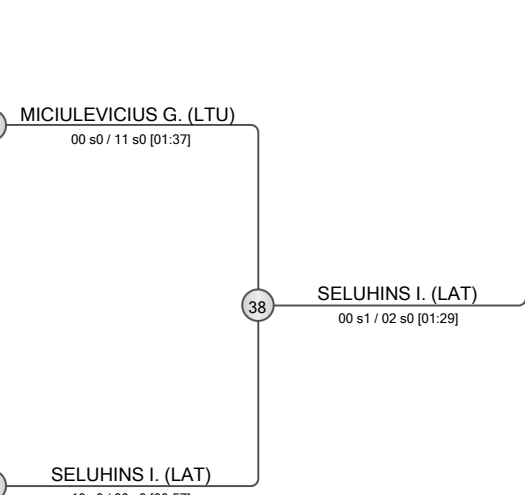
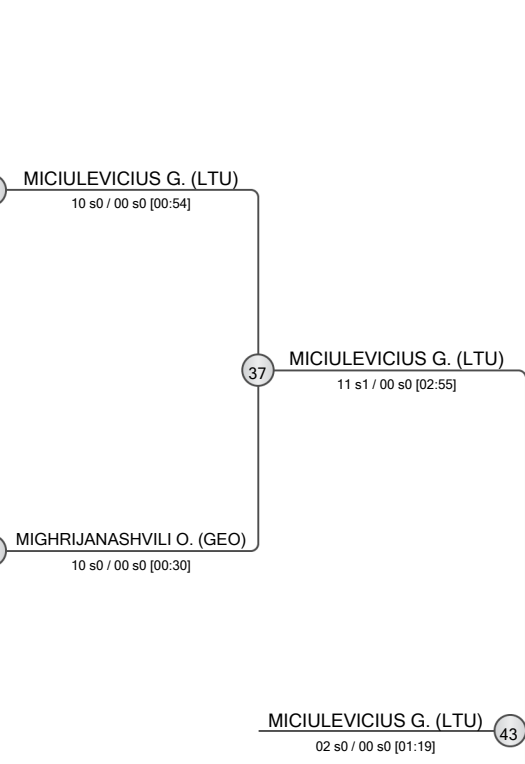

FINAL RESULTS		
1.	MICIULEVICIUS Gilius	LTU
2.	SELUHINS Ildars	LAT
3.	DOBROVOLSIS Mantas	LTU
3.	MIGHRIJANASHVILI Otar	GEO
5.	MICIULEVICIUS Gustas	LTU
5.	PUSKAS Michael	GBR
7.	LELOTKO Dmitrijs	LAT
7.	BANGNOWSKI Tun	LUX





European Hopes Cup Riga 2024

Latvia, Riga, 16-17 Nov 2024

-50 kg

U15 M (18)

POOL A

	OJA Jan Rasmus	EST	1	OJA J. (EST)
	FJODOROV Deniss	LAT	17	01 s1 / 00 s2 [03:00]
	AAL Mattias	EST	2	AAL M. (EST)
	SAKALAUSKAS Adas	LTU	3	SAKALAUSKAS A. (LTU)
	POGORZELSKI Kajetan	POL	4	POGORZELSKI K. (POL)

POOL B

	CERVINSKIS BOGDANS	LAT	5	CERVINSKIS B. (LAT)
	GILCHENKO Nikita	GBR	6	GILCHENKO N. (GBR)
	MOR BARAK OMER	ISR	7	MOR BARAK O. (ISR)
	ABDULZHELILOV BOHDAN	CZE	8	ABDULZHELILOV B. (CZE)

POOL C

	KAUGURS Dominiks	LAT	9	KAUGURS D. (LAT)
	ZVANERS Deivs	LAT	10	ZVANERS D. (LAT)
	YASSUR itay	ISR	11	YASSUR i. (ISR)
	GRUDILOVS Matvejs	LAT	12	GRUDILOVS M. (LAT)

POOL D

	RANDMAA Kristjan	EST	13	BOLISAS D. (LTU)
	BOLISAS Danielius	LTU	23	00 s2 / 01 s0 [03:00]
	CEPELAK Radek	CZE	14	CEPELAK R. (CZE)
	AZARUMYAN Aren	EST	15	AZARUMYAN A. (EST)
	TOMBERG Karl Kaspar	EST	16	TOMBERG K. (EST)

REPECHAGE

OJA J. (EST)	29	OJA J. (EST)	33	OJA J. (EST)
GILCHENKO N. (GBR)	30	GILCHENKO N. (GBR)	34	MOR BARAK O. (ISR)
KAUGURS D. (LAT)	31	KAUGURS D. (LAT)	35	YASSUR i. (ISR)
TOMBERG K. (EST)	32	TOMBERG K. (EST)	36	TOMBERG K. (EST)

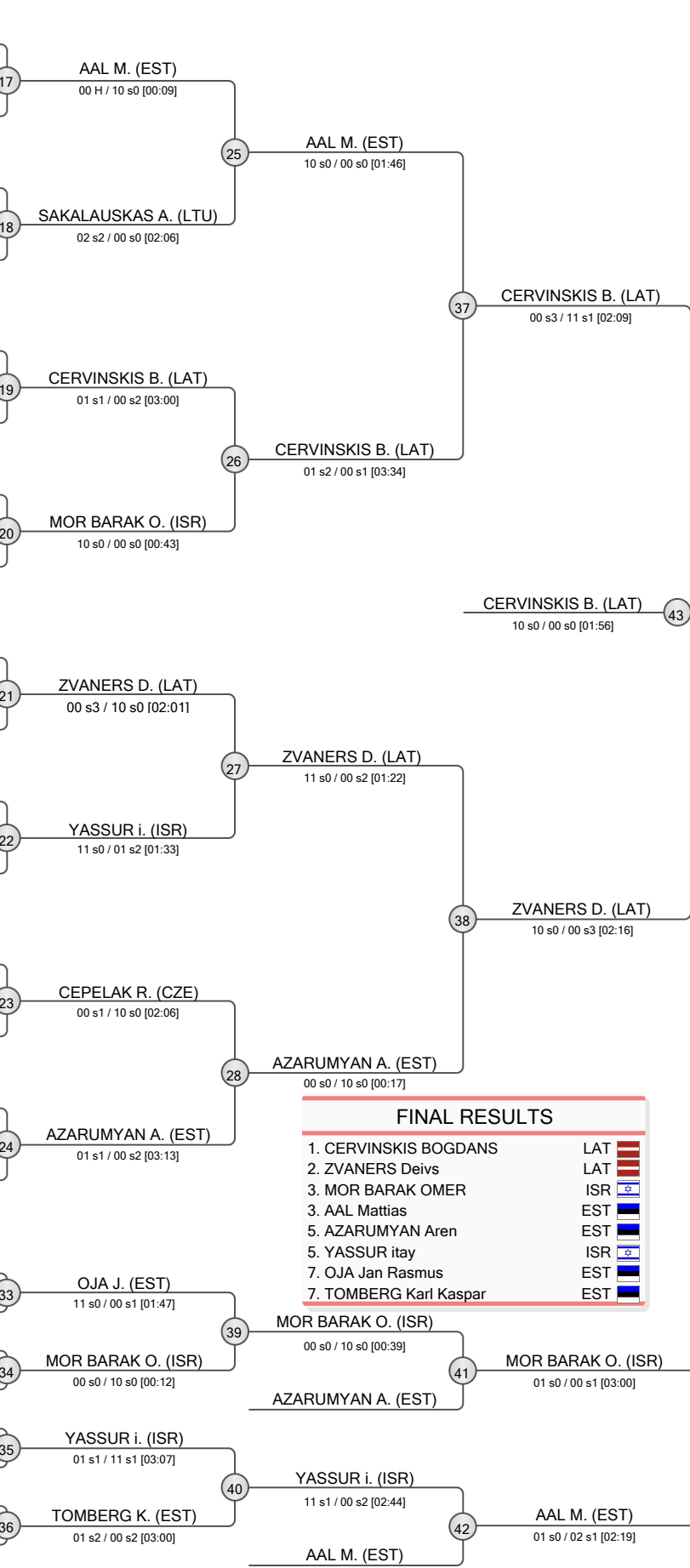

FINAL RESULTS	
1.	CERVINSKIS BOGDANS LAT
2.	ZVANERS Deivs LAT
3.	MOR BARAK OMER ISR
3.	AAL Mattias EST
5.	AZARUMYAN Aren EST
5.	YASSUR itay ISR
7.	OJA Jan Rasmus EST
7.	TOMBERG Karl Kaspar EST





European Hopes Cup Riga 2024

Latvia, Riga, 16-17 Nov 2024

-55 kg

U15 M (20)

POOL A

	APOSTOLOV Mihail	BUL
	SEMJONOV Daniils	LAT
	SOKIRJANSKIS Arsenijs	LAT
	BIRNITIS Janis Jakobs	LAT
	HONIG ariel	ISR

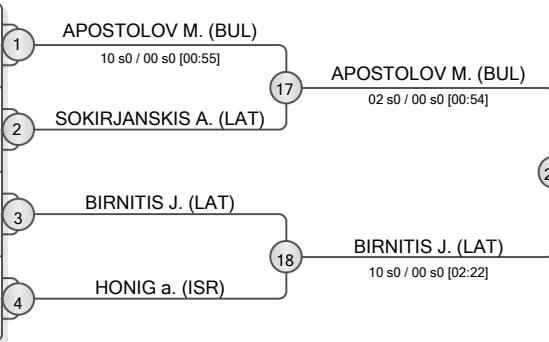

POOL B

	JAKSTEVICS Miks	LAT
	GHOHADZE Irakli	GEO
	VAHTER Romet	EST
	SIDOROV Aleksandrs	LAT
	ZUBAVICIUS Tadas	LTU

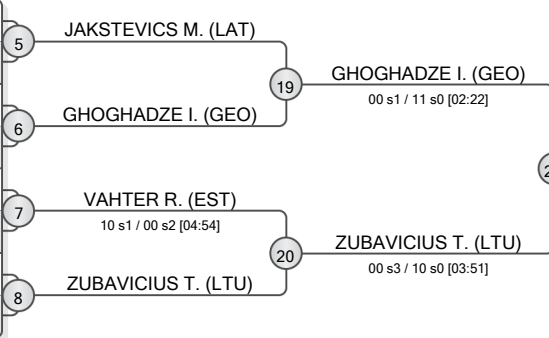

POOL C

	DIACHENKO eitan	ISR
	TAGIJEVS Farids	LAT
	VORONECKIS Tamerlans	LAT
	TALICH Stepan	CZE
	TOOMPARK Taavi	EST

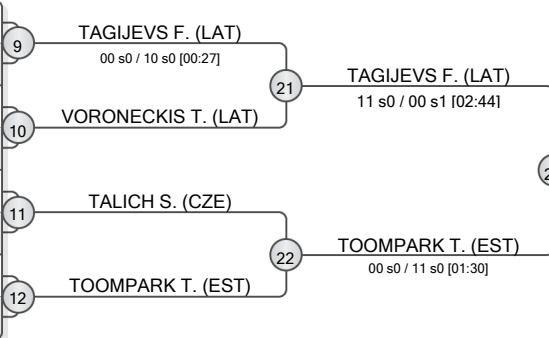

POOL D

	LUSTAC Ismael	LUX
	KRUZE Aleksandrs	LAT
	ROBBINS Zachary	GBR
	ROZENTALS Rafaels	LAT
	LAZORKINS Timofejs	LAT

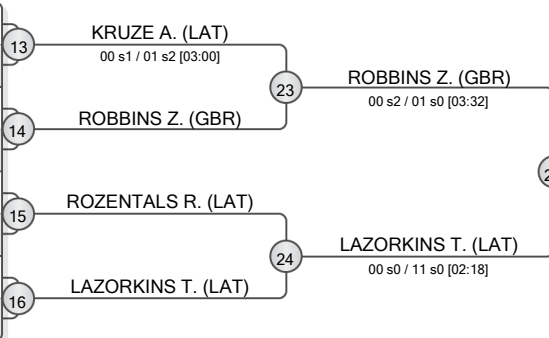

FINAL RESULTS	
1.	LAZORKINS Timofejs LAT
2.	BIRNITIS Janis Jakobs LAT
3.	APOSTOLOV Mihail BUL
3.	ROBBINS Zachary GBR
5.	TOOMPARK Taavi EST
5.	GHOHADZE Irakli GEO
7.	ZUBAVICIUS Tadas LTU
7.	TAGIJEVS Farids LAT

REPECHAGE

HONIG a. (ISR)	29	HONIG a. (ISR)	33	APOSTOLOV M. (BUL)
JAKSTEVICS M. (LAT)	30	JAKSTEVICS M. (LAT)	34	ZUBAVICIUS T. (LTU)
TALICH S. (CZE)	31	TALICH S. (CZE)	35	TAGIJEVS F. (LAT)
ROZENTALS R. (LAT)	32	ROZENTALS R. (LAT)	36	ROBBINS Z. (GBR)

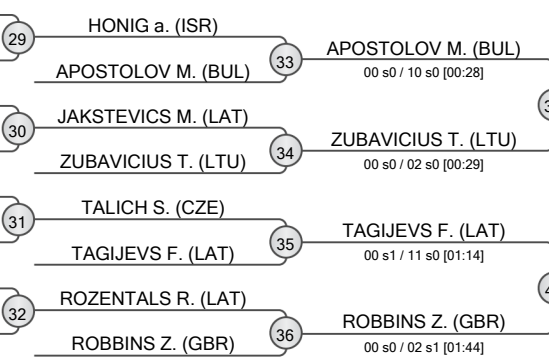



European Hopes Cup Riga 2024

Latvia, Riga, 16-17 Nov 2024

-60 kg

U15 M (21)

POOL A

	TSVETKOV Stefan	BUL	1	SAMKHARADZE L. (GEO)
	SAMKHARADZE Lazare	GEO	2	01 s0 / 10 s0 [00:25]
	VASINS Ruslans	LAT	2	VASINS R. (LAT)
	DIAKITE Malik	POL	3	DIAKITE M. (POL)
	KLACHKOVSKIS Miroslavs	LAT	4	KLACHKOVSKIS M. (LAT)

POOL B

	BIRK Gustav	EST	5	VAELI C. (EST)
	VAELI Christyan	EST	6	00 s0 / 02 s1 [02:49]
	SALAGAJNS Nikita	LAT	6	SALAGAJNS N. (LAT)
	PAVLUHIN ALEXEY	GBR	7	GAGULASHVILI r. (ISR)
	GAGULASHVILI robert yosef	ISR	8	00 s0 / 10 s0 [00:09]
	BEATTIE-LEWIS Tony	GBR	8	BEATTIE-LEWIS T. (GBR)

POOL C

	SMIRNOV Aleks	EST	9	SMIRNOV A. (EST)
	RAIK Laur Kristjan	EST	10	RAIK L. (EST)
	LOWENSTEIN tal	ISR	11	PILECKAS D. (LTU)
	PILECKAS Dovydas	LTU	12	00 s2 / 02 s0 [01:27]
	POMASKOVSKIS Matiss	LAT	12	POMASKOVSKIS M. (LAT)

POOL D

	SISHCHUK Bohdan	UKR	13	SISHCHUK B. (UKR)
	LESNIEKS Nikita	LAT	14	LESNIEKS N. (LAT)
	JONES Jenson	GBR	15	ZAGORSKIS N. (LAT)
	ZAGORSKIS Nikita	LAT	16	00 s0 / 10 s0 [00:09]
	SCHULLER Yan	LUX	16	SCHULLER Y. (LUX)

REPECHAGE

DIAKITE M. (POL)	29	DIAKITE M. (POL)	33	SAMKHARADZE L. (GEO)
BIRK G. (EST)	30	BIRK G. (EST)	34	BEATTIE-LEWIS T. (GBR)
SALAGAJNS N. (LAT)	31	POMASKOVSKIS M. (LAT)	35	POMASKOVSKIS M. (LAT)
LOWENSTEIN t. (ISR)	32	SISHCHUK B. (UKR)	36	ZAGORSKIS N. (LAT)
		SAMKHARADZE L. (GEO)		
		BEATTIE-LEWIS T. (GBR)		
		SMIRNOV A. (EST)		
		ZAGORSKIS N. (LAT)		

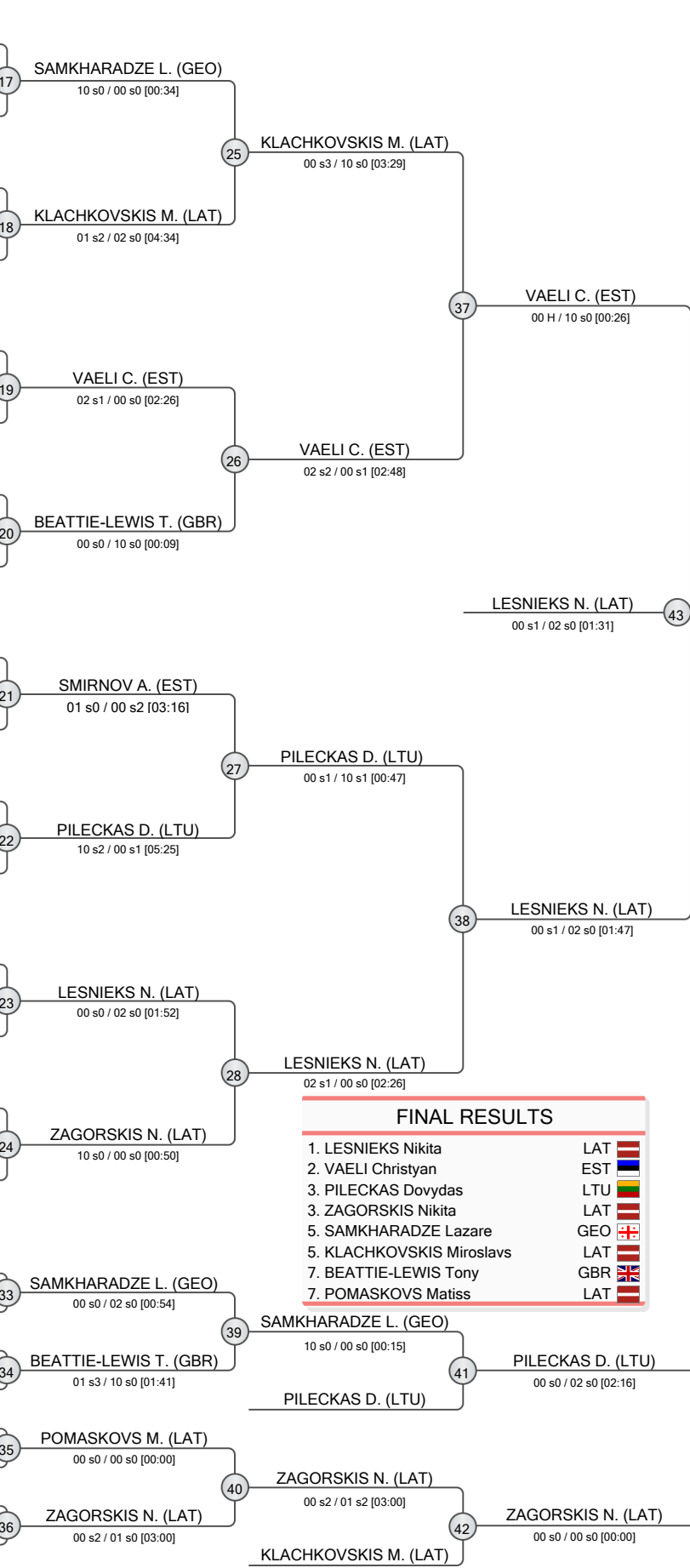

FINAL RESULTS	
1. LESNIEKS Nikita	LAT
2. VAELI Christyan	EST
3. PILECKAS Dovydas	LTU
3. ZAGORSKIS Nikita	LAT
5. SAMKHARADZE Lazare	GEO
5. KLACHKOVSKIS Miroslavs	LAT
7. BEATTIE-LEWIS Tony	GBR
7. POMASKOVSKIS Matiss	LAT





European Hopes Cup Riga 2024

Latvia, Riga, 16-17 Nov 2024

-66 kg

U15 M (11)

POOL A

	GHVALADZE Davit	GEO
	BARZDAINS Ricards	LAT
	TOOMEL Joosep	EST

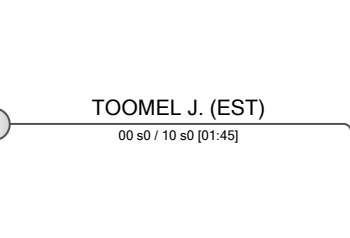
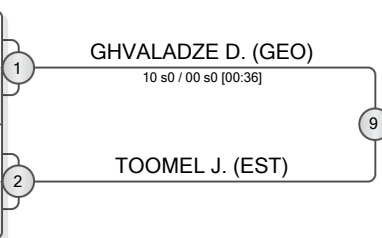

POOL B

	KRIGERS Reinis	LAT
	PAPUNASHVILI Andro	GEO

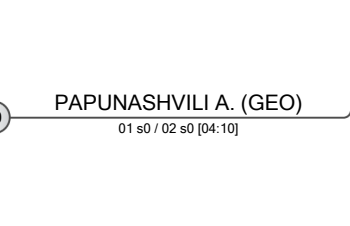
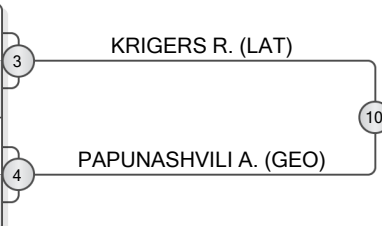

POOL C

	METREVELI Luka	GEO
	HORONKO Aleksejs	LAT
	NIKOLCHEV Ivan	BUL

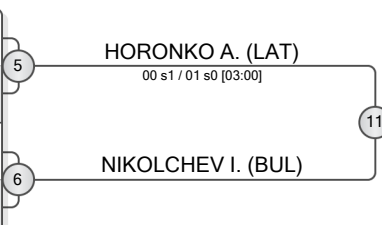

POOL D

	MALUSEVS Bogdans	LAT
	ALEKSEJUJS Timurs	LAT
	STOYKOV Georgi	BUL

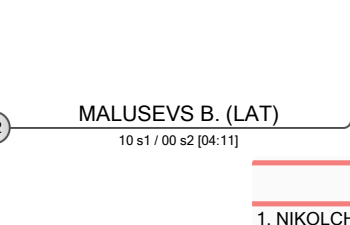
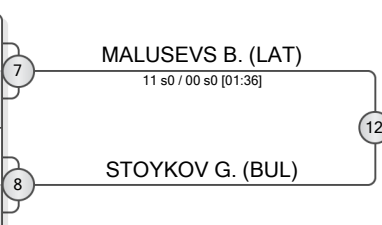

FINAL RESULTS		
1.	NIKOLCHEV Ivan	BUL
2.	PAPUNASHVILI Andro	GEO
3.	KRIGERS Reinis	LAT
3.	TOOMEL Joosep	EST
5.	MALUSEVS Bogdans	LAT
5.	STOYKOV Georgi	BUL
7.	GHVALADZE Davit	GEO
7.	HORONKO Aleksejs	LAT

REPECHAGE

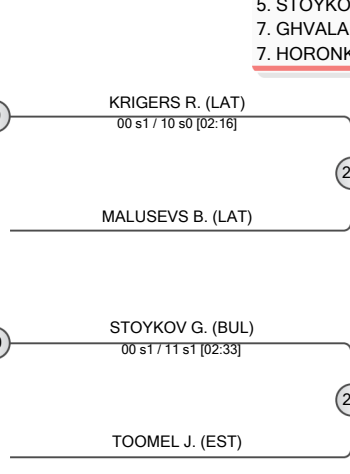
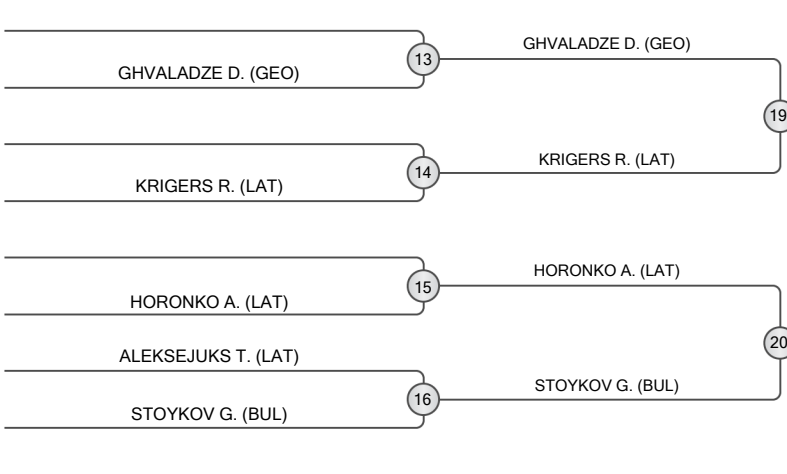



European Hopes Cup Riga 2024

Latvia, Riga, 16-17 Nov 2024

-73 kg

U15 M (9)

POOL A

	OZOLS Mikus	LAT
	DOBRZANSKIS Renats	LAT
	VOLODENOKS Mihails	LAT

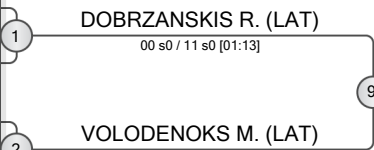

VOLODENOKS M. (LAT) 00 s3 / 10 s0 [02:37]

KALYNIAK O. (UKR) 00 s2 / 01 s2 [04:04]

POOL B

	NURM August Martin	EST
	KALYNIAK Oleh	UKR

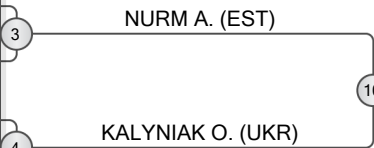

KALYNIAK O. (UKR) 01 s1 / 02 s2 [04:10]

CHARENKA K. (LTU) 00 s0 / 01 s0 [03:00]

POOL C

	KAROLS MARJANS	LAT
	CHARENKA KAJUS	LTU

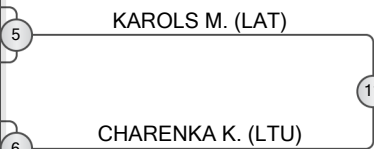

CHARENKA K. (LTU) 00 s2 / 02 s1 [02:53]

CHARENKA K. (LTU) 10 s2 / 00 s3 [05:21]

POOL D

	VEIVERIS Justinas	LTU
	ALIKHANOV Amir	EST

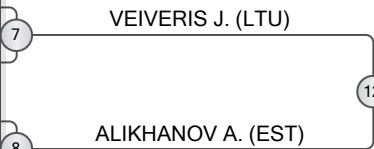

ALIKHANOV A. (EST) 00 s0 / 11 s0 [01:13]

FINAL RESULTS		
1.	CHARENKA KAJUS	LTU
2.	KALYNIAK Oleh	UKR
3.	ALIKHANOV Amir	EST
5.	KAROLS MARJANS	LAT
5.	DOBRZANSKIS Renats	LAT
5.	VOLODENOKS Mihails	LAT

REPECHAGE

DOBRZANSKIS R. (LAT)	13	DOBRZANSKIS R. (LAT)
NURM A. (EST)	14	NURM A. (EST)
KAROLS M. (LAT)	15	KAROLS M. (LAT)
VEIVERIS J. (LTU)	16	VEIVERIS J. (LTU)

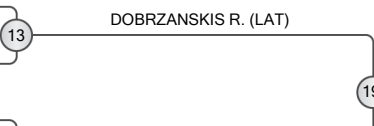

DOBRZANSKIS R. (LAT) 10 s0 / 00 s1 [01:19]

ALIKHANOV A. (EST) 00 s0 / 10 s1 [01:18]

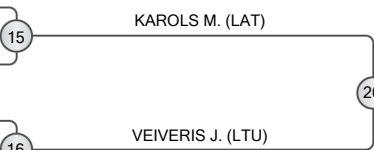

KAROLS M. (LAT) 10 s0 / 00 s0 [00:55]

KAROLS M. (LAT) 10 s0 / 01 s2 [01:44]





European Hopes Cup Riga 2024

Latvia, Riga, 16-17 Nov 2024

+73 kg

U15 M (12)

POOL A

	NAMURADZE Giorgi	GEO
	RAGS Ostins	LAT
	PODKUJKO Igors	LAT

POOL B

	ANDREJEVS Deniss	LAT
	PATEJENOKS Alekss	LAT
	SIKULJAK Relja	BIH

POOL C

	SIDLAUSKAS JOKUBAS	LTU
	ZUKS Glebs	LAT
	VLADIMIROVS Vilens	LAT

POOL D

	CELENBERGS Tomass Gustavs	LAT
	BRUNNER Jan	CZE
	LIPPUS Hubert	EST

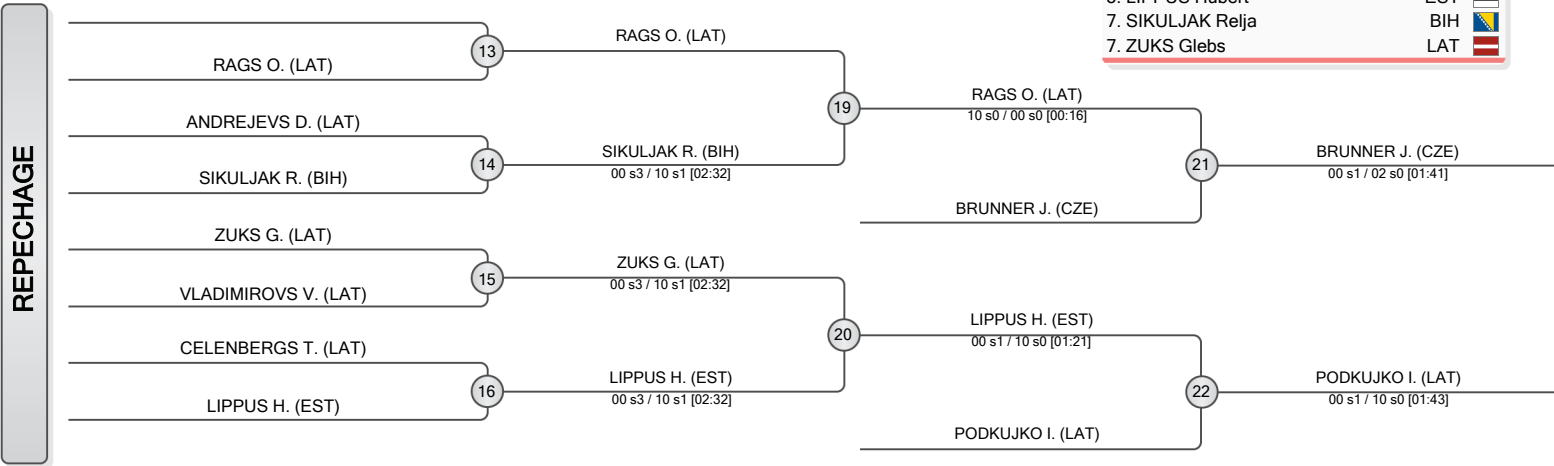

FINAL RESULTS		
1.	PATEJENOKS Alekss	LAT
2.	SIDLAUSKAS JOKUBAS	LTU
3.	BRUNNER Jan	CZE
3.	PODKUJKO Igors	LAT
5.	RAGS Ostins	LAT
5.	LIPPUS Hubert	EST
7.	SIKULJAK Relja	BIH
7.	ZUKS Glebs	LAT





European Hopes Cup Riga 2024

Latvia, Riga, 16-17 Nov 2024

-40 kg

U15 F (3)

Num.	Competitor	State	1	2	3	Wins	Points
1.	FILIPOVIC Mia	Serbia		0	0	0	0
2.	GRACOVA Dominika	Czechia	10		10	2	20
3.	ORTMANOVA Ludmila	Czechia	10	0		1	10

FILIPOVIC Mia	SRB	1	GRACOVA D. (CZE)
GRACOVA Dominika	CZE		

00 s2 / 02 s0 [00:29]

FINAL RESULTS	
1. GRACOVA Dominika	CZE
2. ORTMANOVA Ludmila	CZE

FILIPOVIC Mia	SRB	2	ORTMANOVA L. (CZE)
ORTMANOVA Ludmila	CZE		

00 H / 10 s0 [01:38]

GRACOVA Dominika	CZE	3	GRACOVA D. (CZE)
ORTMANOVA Ludmila	CZE		

11 s0 / 00 s3 [02:58]





European Hopes Cup Riga 2024

Latvia, Riga, 16-17 Nov 2024

-44 kg

U15 F (5)

Num.	Competitor	State	1	2	3	4	5	Wins	Points
1.	DODDS Neve	Great Britain		0	0	0	0	0	0
2.	GIGILASHVILI Tatia	Georgia	10		10	0	10	3	30
3.	SAKLAURE Lauma Liva	Latvia	10	0		0	10	2	20
4.	MAVROVA Sofia	Bulgaria	10	10	10		10	4	40
5.	EIMUTYTE Goda	Lithuania	1	0	0	0		1	1

DODDS Neve	GBR
GIGILASHVILI Tatia	GEO
SAKLAURE Lauma Liva	LAT
MAVROVA Sofia	BUL

1	GIGILASHVILI T. (GEO)	00 s0 / 02 s0 [01:05]
2	MAVROVA S. (BUL)	00 s0 / 10 s0 [00:56]

FINAL RESULTS		
1. MAVROVA Sofia	BUL	
2. GIGILASHVILI Tatia	GEO	
3. SAKLAURE Lauma Liva	LAT	
4. EIMUTYTE Goda	LTU	

DODDS Neve	GBR
EIMUTYTE Goda	LTU
GIGILASHVILI Tatia	GEO
SAKLAURE Lauma Liva	LAT

3	EIMUTYTE G. (LTU)	00 s0 / 01 s2 [03:00]
4	GIGILASHVILI T. (GEO)	10 s0 / 00 s3 [02:44]

MAVROVA Sofia	BUL
EIMUTYTE Goda	LTU
DODDS Neve	GBR
SAKLAURE Lauma Liva	LAT

5	MAVROVA S. (BUL)	11 s0 / 00 s1 [03:00]
6	SAKLAURE L. (LAT)	00 s0 / 10 s0 [00:08]

GIGILASHVILI Tatia	GEO
EIMUTYTE Goda	LTU
DODDS Neve	GBR
MAVROVA Sofia	BUL

7	GIGILASHVILI T. (GEO)	02 s0 / 00 s0 [01:29]
8	MAVROVA S. (BUL)	00 s0 / 10 s0 [00:00]

SAKLAURE Lauma Liva	LAT
EIMUTYTE Goda	LTU
GIGILASHVILI Tatia	GEO
MAVROVA Sofia	BUL

9	SAKLAURE L. (LAT)	10 s0 / 00 s0 [00:12]
10	MAVROVA S. (BUL)	00 s2 / 10 s1 [04:05]





European Hopes Cup Riga 2024

Latvia, Riga, 16-17 Nov 2024

-52 kg

U15 F (10)

POOL A

	GULIASHVILI Mariam	GEO
	SIPKOVA Aneta	CZE

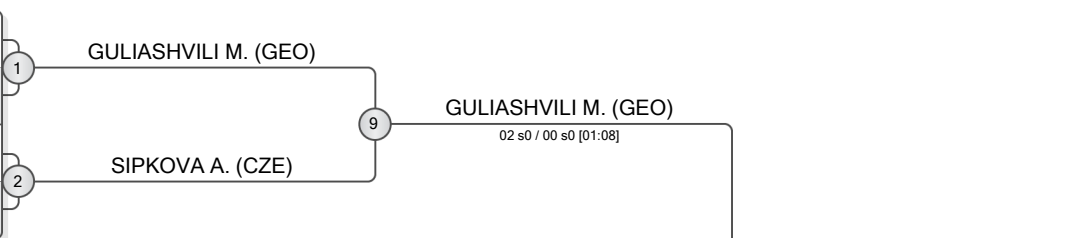

POOL B

	GULBANI Tinatin	GEO
	GAIGALAITE MONIKA	LTU
	BUCINSKAITE IRUNA	LTU

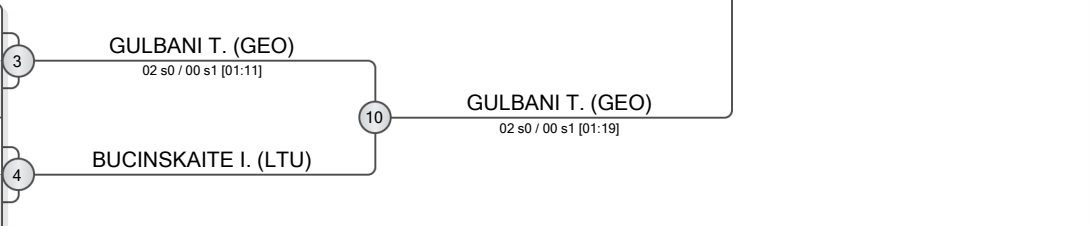

POOL C

	MARKOVA Maraya	BUL
	ZEMESA Marta	LAT
	CIBULSKAITE RUSNE	LTU

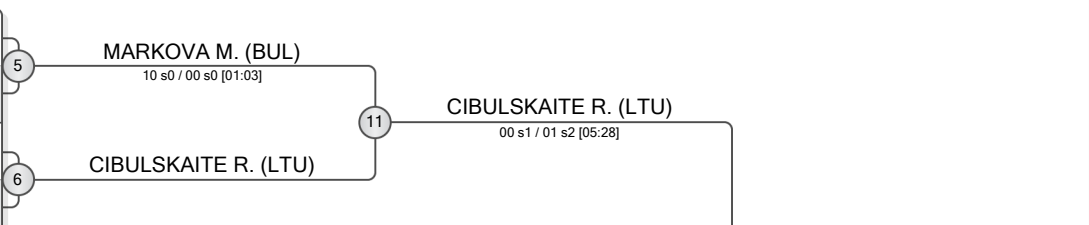

POOL D

	GRIKE LINDA	LAT
	BUZINA Anastasia	EST

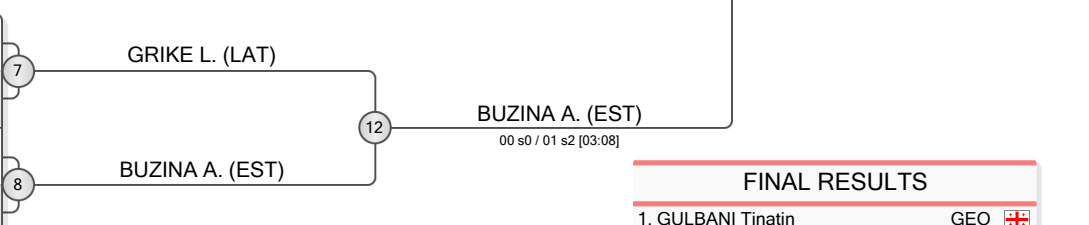

FINAL RESULTS		
1.	GULBANI Tinatin	GEO
2.	CIBULSKAITE RUSNE	LTU
3.	GAIGALAITE MONIKA	LTU
3.	GULIASHVILI Mariam	GEO
5.	BUZINA Anastasia	EST
5.	MARKOVA Maraya	BUL

REPECHAGE

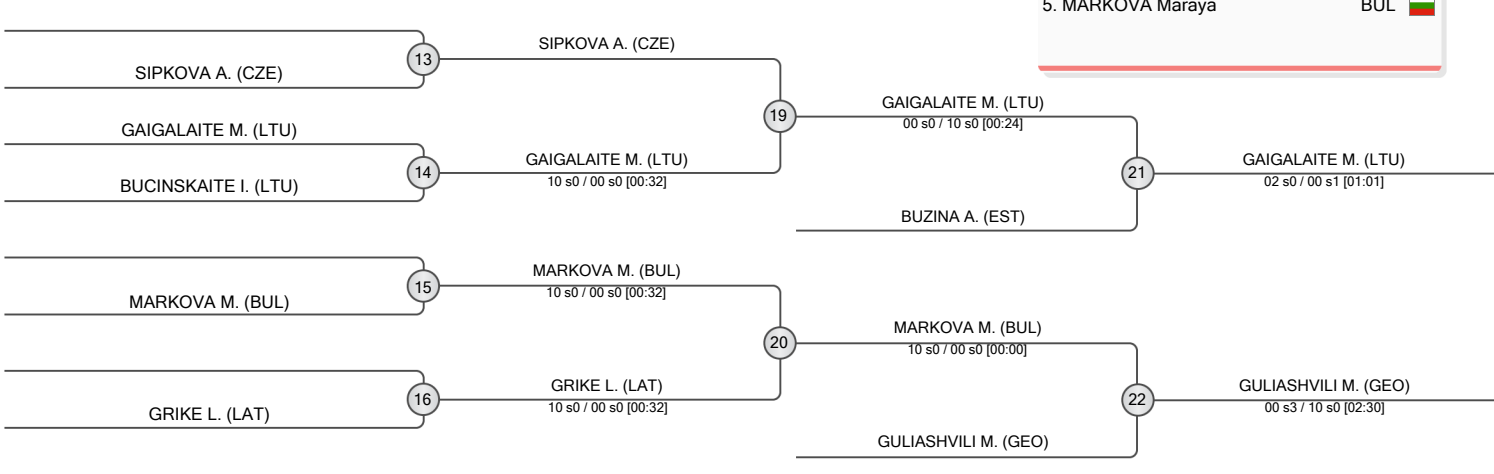



European Hopes Cup Riga 2024

Latvia, Riga, 16-17 Nov 2024

-57 kg

U15 F (10)

POOL A

	SABIASHVILI Nene	GEO
	JARVE Mirjam	EST
	STUMBREVICIUTE Daniela	LTU

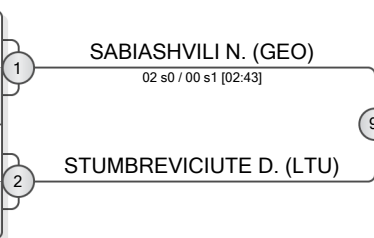

POOL B

	KAZRADZE Katrina Anna	LAT
	KHARAZISHVILI Ketevan	GEO

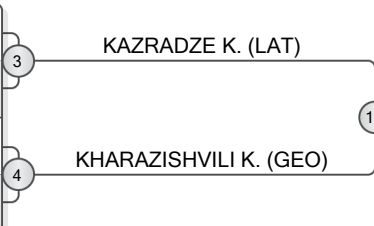

POOL C

	SMIDOVA Aneta	CZE
	BECHVAIA Liza	GEO

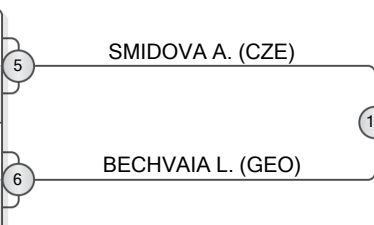

POOL D

	STOYANOVA Marina	BUL
	LASS Cara	EST
	AMICHAY ALMA	ISR

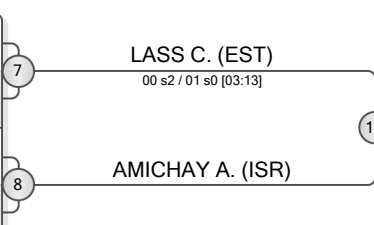

REPECHAGE

JARVE M. (EST)	13
STUMBREVICIUTE D. (LTU)	14
KAZRADZE K. (LAT)	15
BECHVAIA L. (GEO)	16
LASS C. (EST)	17

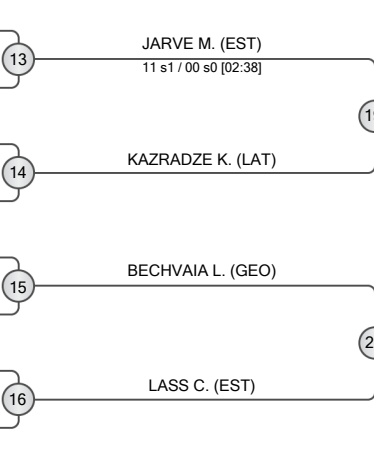

FINAL RESULTS		
1.	SABIASHVILI Nene	GEO
2.	AMICHAY ALMA	ISR
3.	SMIDOVA Aneta	CZE
3.	KHARAZISHVILI Ketevan	GEO
5.	KAZRADZE Katrina Anna	LAT
5.	LASS Cara	EST
7.	JARVE Mirjam	EST





European Hopes Cup Riga 2024

Latvia, Riga, 16-17 Nov 2024

-63 kg

U15 F (12)

POOL A

	JUSEVICIUTE Radvile	LTU
	HRUBA Viktorie	CZE
	GLUHOVSKA Nikola	LAT

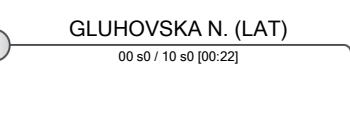
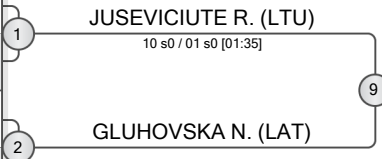

POOL B

	ALTUNSOY Derin RUYA	TUR
	GAZDIKOVA Marketa	CZE
	SOPAITE IRUNA	LTU

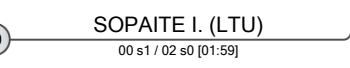
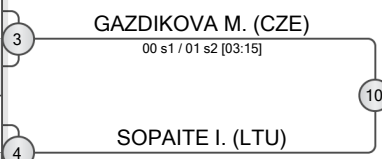

POOL C

	PONOMARENKO MARIIA Mariia	GER
	ANDRIUSKEVICIUTE Aukse	LTU
	OLEV Heleri	EST

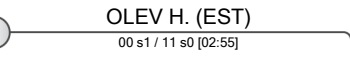
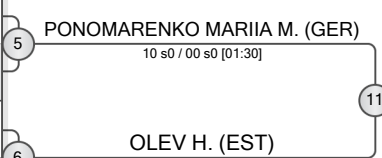

POOL D

	PICKULE Raita	LAT
	DAVADZE Liza	GEO
	UKASA Agnese	LAT

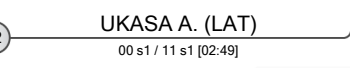
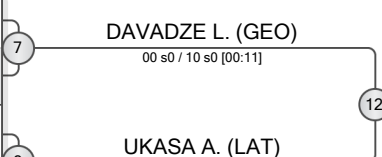

REPECHAGE

13	JUSEVICIUTE R. (LTU)
14	GAZDIKOVA M. (CZE)
15	PONOMARENKO MARIIA M. (GER)
16	DAVADZE L. (GEO)

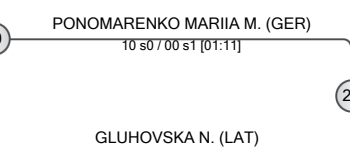
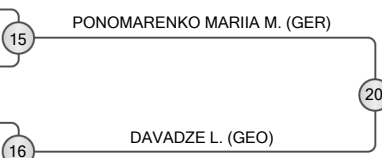
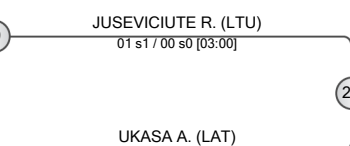
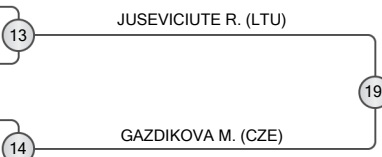

FINAL RESULTS		
1.	OLEV Heleri	EST
2.	SOPAITE IRUNA	LTU
3.	JUSEVICIUTE Radvile	LTU
3.	PONOMARENKO MARIIA Mariia	GER
5.	UKASA Agnese	LAT
5.	GLUHOVSKA Nikola	LAT
7.	GAZDIKOVA Marketa	CZE
7.	DAVADZE Liza	GEO





European Hopes Cup Riga 2024

Latvia, Riga, 16-17 Nov 2024

-70 kg

U15 F (7)

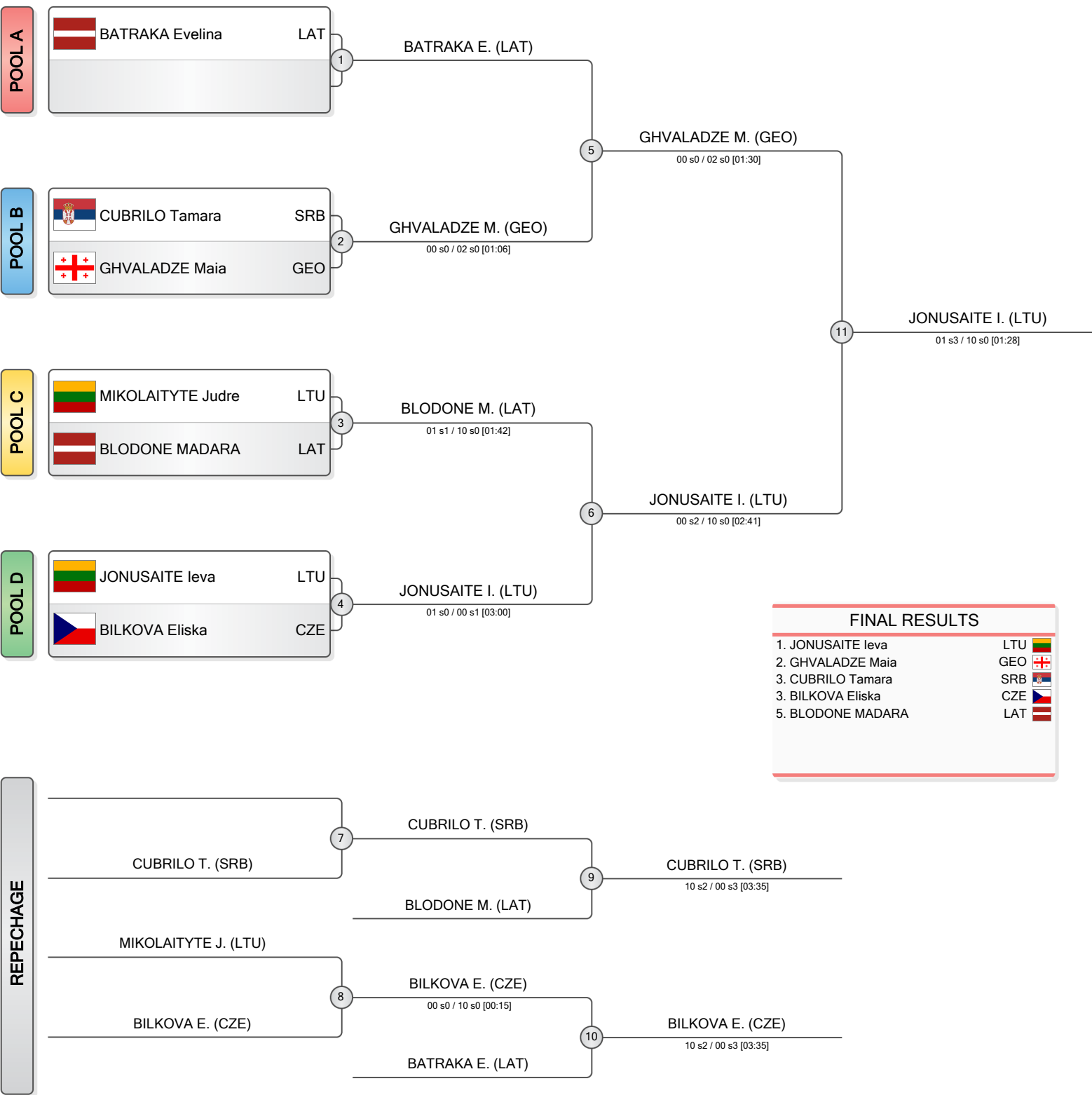

FINAL RESULTS	
1. JONUSAITE Ieva	LTU
2. GHVALADZE Maia	GEO
3. CUBRILO Tamara	SRB
3. BILKOVA Eliska	CZE
5. BLODONE MADARA	LAT





European Hopes Cup Riga 2024

Latvia, Riga, 16-17 Nov 2024

+ 70 kg

U15 F (5)

Num.	Competitor	State	1	2	3	4	5	Wins	Points
1.	ZAHHAROVA ANASTASIA	Estonia		10	0	10	10	3	30
2.	POZERAITE Justina	Lithuania	0		0	0	10	1	10
3.	SHALAMBERIDZE Lika	Georgia	1	10		10	10	4	31
4.	KHOSROSHVILI Magda	Georgia	0	10	0		0	1	10
5.	DYBA Alicja	Poland	0	0	0	10		1	10

ZAHHAROVA ANASTASIA	EST
POZERAITE Justina	LTU
SHALAMBERIDZE Lika	GEO
KHOSROSHVILI Magda	GEO

1	ZAHHAROVA A. (EST)	11 s0 / 00 s0 [01:53]
2	SHALAMBERIDZE L. (GEO)	10 s2 / 00 s2 [02:15]

FINAL RESULTS		
1. SHALAMBERIDZE Lika	GEO	
2. ZAHHAROVA ANASTASIA	EST	
3. POZERAITE Justina	LTU	
4. DYBA Alicja	POL	
5. KHOSROSHVILI Magda	GEO	

ZAHHAROVA ANASTASIA	EST
DYBA Alicja	POL
POZERAITE Justina	LTU
SHALAMBERIDZE Lika	GEO

3	ZAHHAROVA A. (EST)	10 s0 / 00 s3 [01:59]
4	SHALAMBERIDZE L. (GEO)	00 s1 / 02 s2 [01:51]

KHOSROSHVILI Magda	GEO
DYBA Alicja	POL
ZAHHAROVA ANASTASIA	EST
SHALAMBERIDZE Lika	GEO

5	DYBA A. (POL)	00 s1 / 02 s0 [01:10]
6	SHALAMBERIDZE L. (GEO)	00 s2 / 01 s2 [03:00]

POZERAITE Justina	LTU
DYBA Alicja	POL
ZAHHAROVA ANASTASIA	EST
KHOSROSHVILI Magda	GEO

7	POZERAITE J. (LTU)	10 s0 / 00 s3 [00:57]
8	ZAHHAROVA A. (EST)	10 s2 / 00 s0 [01:50]

SHALAMBERIDZE Lika	GEO
DYBA Alicja	POL
POZERAITE Justina	LTU
KHOSROSHVILI Magda	GEO

9	SHALAMBERIDZE L. (GEO)	11 s0 / 00 s0 [00:23]
10	KHOSROSHVILI M. (GEO)	00 s3 / 10 s1 [02:14]

