



Thessaloniki Cadet European Cup 2024

Greece, Thessaloniki, 23-24 Nov 2024

-50 kg

Men (23)

POOL A

	MARTINOV Tsvetelin	BUL
	ANASTASOV Pavlos	GRE
	TROULLIDES Nasos	CYP
	ATANASOV Atanas	BUL
	GILBERT Coen	GBR
	MDINARADZE Tornike	GEO

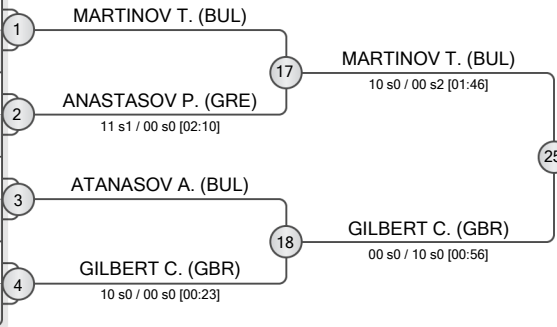

POOL B

	CHIARELLA Luca	ITA
	NIKOLAKOPOULOS Antonios	GRE
	HOFFMANN Andrea	FRA
	SPINU Arsenijs	LAT
	DJOKIC Ignjat	SRB
	MARCHIORI Ugo	LUX

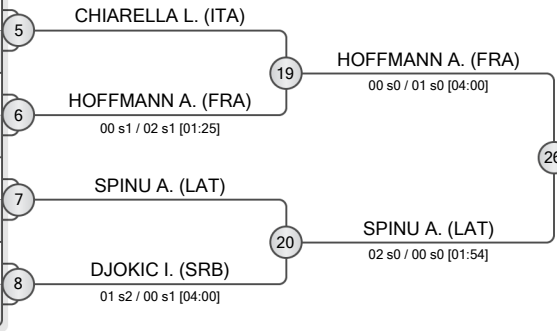

POOL C

	ALEKSIEJUNAS Natas	LTU
	OZDEMIR Muhammed Enes	TUR
	GULIYEV Anar	AZE
	SHEMESH Shachar	ISR
	ANASTASOPOULOS Dimitrios-Dionysios	GRE

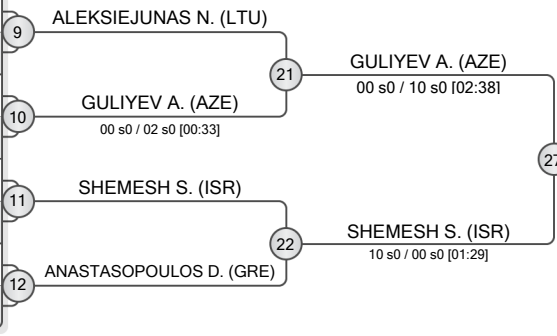

POOL D

	PENEZ Enzo	FRA
	DUMBADZE Giorgi	GEO
	FELLOUKA Loizos	CYP
	GART Lidor	ISR
	SARACHEV Denislav	BUL
	SEILKHAN Daniyal	KAZ

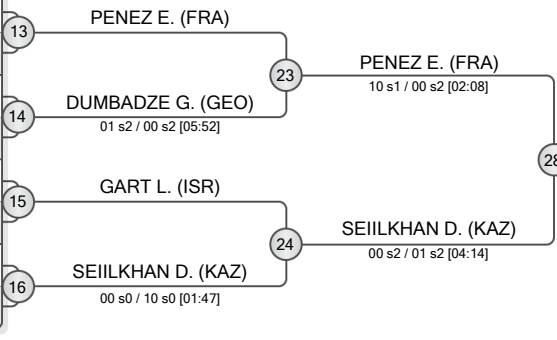

REPECHAGE

29	ANASTASOV P. (GRE)	33	GILBERT C. (GBR)
30	DJOKIC I. (SRB)	34	HOFFMANN A. (FRA)
31	ALEKSIEJUNAS N. (LTU)	35	ALEKSIEJUNAS N. (LTU)
32	GART L. (ISR)	36	PENEZ E. (FRA)

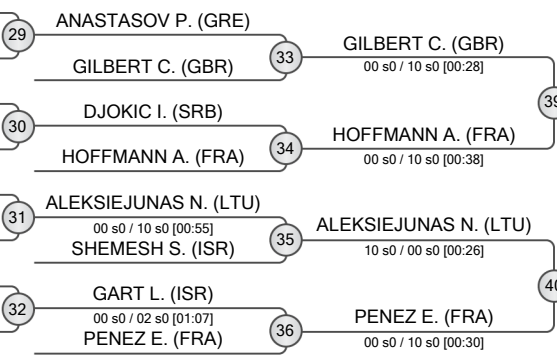

FINAL RESULTS

1. MARTINOV Tsvetelin BUL
2. SEILKHAN Daniyal KAZ
3. GULIYEV Anar AZE
3. PENEZ Enzo FRA
5. GILBERT Coen GBR
5. SPINU Arsenijs LAT
7. HOFFMANN Andrea FRA
7. ALEKSIEJUNAS Natas LTU





Thessaloniki Cadet European Cup 2024

Greece, Thessaloniki, 23-24 Nov 2024

-55 kg

Men (41)

POOL A

	JAKUBAUSKAS Adris	LTU	1
	STEFANOV Samuil	BUL	2
	CUU Axel	FRA	3
	PARIPOVIC Andrija	CRO	3
	MIZRAHI Ori	ISR	4
	HUSEYNLI Emil	AZE	5
	MALCA Yair	ISR	6
	MAVRIDIS Leonidas	GRE	7
	UCAR Mehmet Ali	TUR	7
	YERGALIYEV Aslan	KAZ	8

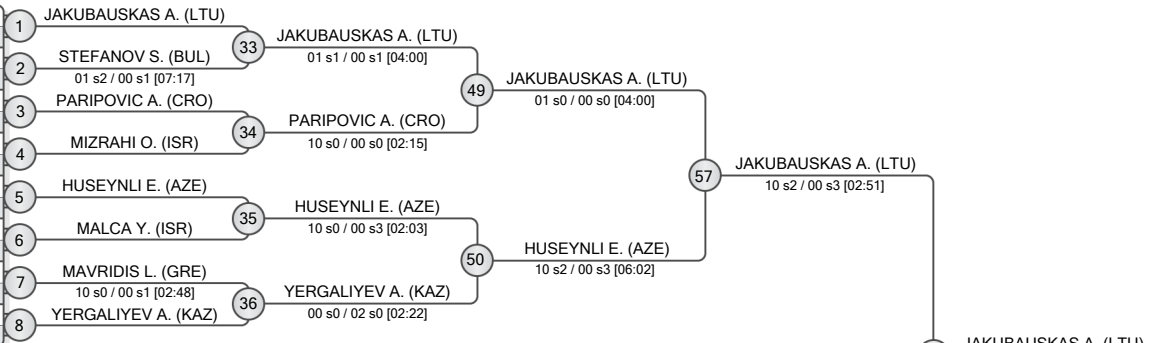

POOL B

	MAKULAVICIUS Rokas	LTU	9
	HAGILADY DAUM Alon	ISR	10
	HUSIYEV Mahammadali	AZE	11
	MUGGIANU Matteo	ITA	11
	MITOVSKI Denis	BUL	12
	MILOSEVIC Aleksa	SRB	13
	PILAUARI Saba	GEO	14
	ZAIMIDIS Petros	GRE	14
	LEFORESTIER Corentin	FRA	15
	STOYANOV Mihail	BUL	16

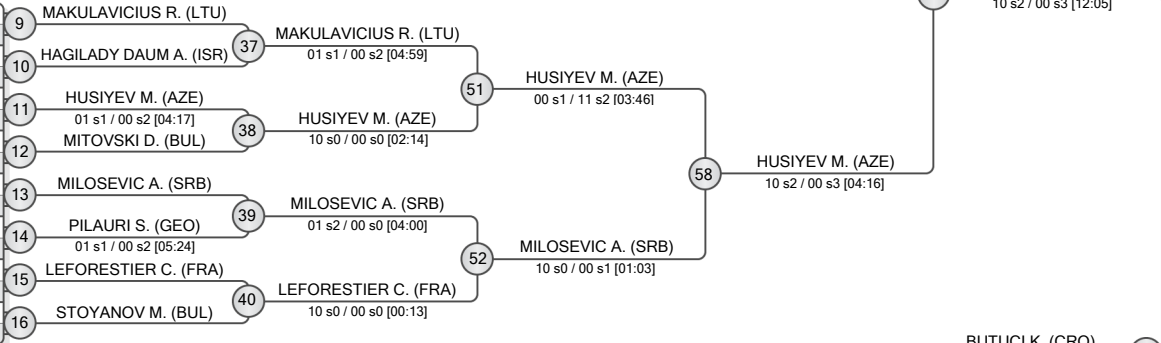

POOL C

	LUCAS Titouan	FRA	17
	MILUSHEV Deyan	BUL	18
	GASIMZADE Rustam	AZE	18
	PETROVIC Nikola	SRB	19
	STAAL Rotem	ISR	20
	GALENKOV Ivo	BUL	21
	KALOGIROS Georgios	GRE	22
	ZYCHLINSKI Ido	ISR	22
	SINDJIC Balsa	MNE	23
	SOFIOGLOU Nikolaos	GRE	23
	SANDRINI Angelo Karol	ITA	24

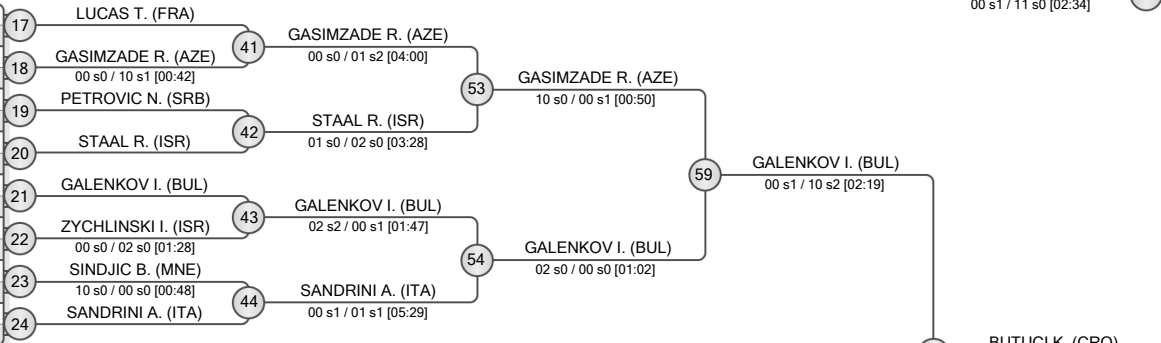

POOL D

	BUTUCI Kristian	CRO	25
	BOUNTAGKIDIS Alexandros	CYP	26
	AMANGELDY Beknur	KAZ	27
	TOREN Noam	ISR	27
	SPANOS Theodoros	GRE	28
	SORICI Alin Marian	ROU	29
	CALARNOU Evan	FRA	30
	RUSTAMLI Mahammad	AZE	30
	ZIRAKASHVILI Merabi	GEO	31
	GEORGIEV Valentin	BUL	32

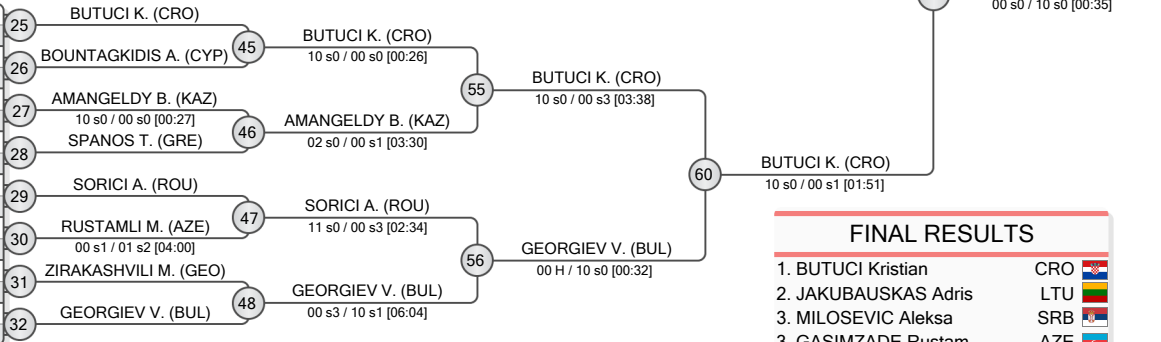

FINAL RESULTS		
1.	BUTUCI Kristian	CRO
2.	JAKUBAUSKAS Adris	LTU
3.	MILOSEVIC Aleksa	SRB
3.	GASIMZADE Rustam	AZE
5.	GALENKOV Ivo	BUL
5.	HUSIYEV Mahammadali	AZE
7.	HUSEYNLI Emil	AZE
7.	AMANGELDY Beknur	KAZ

REPECHAGE

61	STEFANOV S. (BUL)	61	STEFANOV S. (BUL)
62	MUGGIANU M. (ITA)	62	MUGGIANU M. (ITA)
63	MITOVSKI D. (BUL)	63	ZYCHLINSKI I. (ISR)
64	BOUNTAGKIDIS A. (CYP)	64	AMANGELDY B. (KAZ)

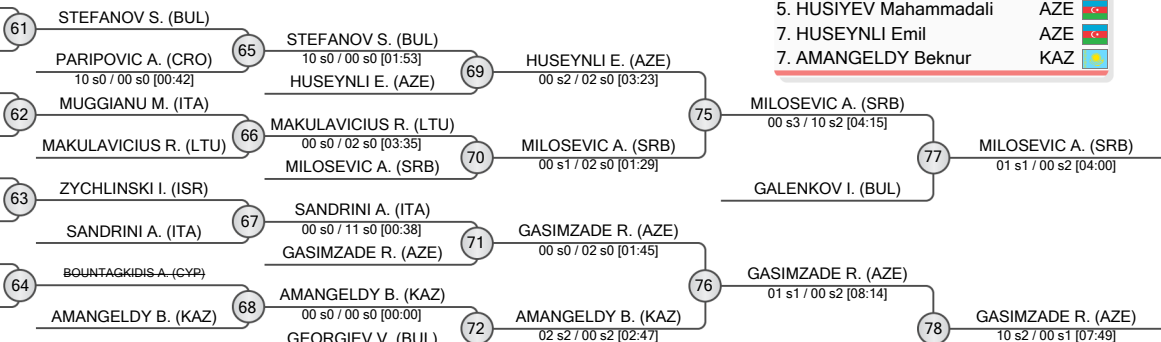



Thessaloniki Cadet European Cup 2024

Greece, Thessaloniki, 23-24 Nov 2024

-60 kg

Men (61)

POOL A

KONYSBAY Altynbek	KAZ	1	KONYSBAY A. (KAZ)	33	KONYSBAY A. (KAZ)
FOUSTERIS Panagiotis	GRE	2	THIRY L. (FRA)	00 s0 / 10 s0 [00:48]	10 s0 / 00 s0 [02:25]
THIRY Louis	FRA	2	SHTAIN T. (ISR)	00 s0 / 10 s1 [02:42]	02 s0 / 00 s1 [04:00]
ADYLBKOV Alymbek	KGZ	3	AVRAMOVIC V. (SRB)	10 s0 / 00 H [06:05]	
SHTAIN Tomer	ISR	3	IONITA D. (ROU)	10 s0 / 00 s0 [00:26]	
AVRAMOVIC Vanja	SRB	4	KARIMOV A. (AZE)	00 s1 / 01 s1 [04:00]	
KARIPIDIS Marios	GRE	4	KANJARASHVILI L. (GEO)	01 s0 / 00 s0 [04:00]	
IONITA David	ROU	5	KORAIAT I. (ISR)	00 H / 10 s0 [04:54]	
MAGEIRIAS Nikitas	GRE	5			
AFXENTIOU Afxentis	CYP	6			
KARIMOV Abdullah	AZE	6			
KANJARASHVILI Luka	GEO	7			
POLYCHRONIDIS Alexandros	GRE	7			
DOBREV Hristiyan	BUL	8			
KORAIAT Ido	ISR	8			

POOL B

ERLANDSEN-SELE Brink	NOR	9	ROTSOS P. (GRE)	01 s2 / 02 s1 [03:03]	00 s0 / 10 s0 [00:49]
ROTSOS Petros	GRE	9	SASSI T. (ITA)	00 s0 / 02 s0 [00:25]	
TEKIN Suleyman	TUR	10	HADJIYIANNIS N. (CYP)	01 s1 / 00 s0 [08:35]	00 s1 / 01 s2 [04:23]
SASSI Thomas	ITA	10	MCHEDLISHVILI N. (GEO)	10 s0 / 00 s0 [01:01]	
HADJIYIANNIS Nestoras	CYP	11	TOMASIC M. (CRO)	10 s0 / 00 s3 [03:25]	
SOPILIDIS Georgios	GRE	11	NITSAN B. (ISR)	10 s0 / 00 s0 [01:12]	
MCHEDLISHVILI Nikoloz	GEO	12	YOMBI ITOUA J. (FRA)	11 s0 / 00 s0 [00:36]	
YAACOBI Liav	ISR	12	DOSBERGEN N. (KAZ)	11 s0 / 00 s0 [01:28]	
TOMASIC Mateo	CRO	13			
GEORGIAKIS Konstantinos	GRE	13			
NITSAN Boaz	ISR	14			
DIMITROV Stylianos	CYP	14			
YOMBI ITOUA Jason	FRA	15			
MIHAYLOV Boris	BUL	15			
DOSBERGEN Nurdos	KAZ	16			
GIANNAKIS Georgios	GRE	16			

POOL C

BREKKE-JENSSEN Torstein	NOR	17	BREKKE-JENSSEN T. (NOR)	00 s0 / 10 s0 [02:34]	01 s0 / 00 s2 [04:37]
CHOLAKOV Hristo	BUL	18	HOCHMAN I. (ISR)	01 s2 / 00 s1 [05:23]	01 s2 / 00 s2 [04:00]
BOUKOUVALAS Maximos-Orestis	GRE	18	POSNAKIDIS T. (GRE)	00 s0 / 02 s1 [02:27]	
HOCHMAN Itay	ISR	19	IGILIK M. (KAZ)	10 s0 / 00 s0 [02:07]	
NANCEY Noe	FRA	19	GARAYEV I. (AZE)	01 s0 / 02 s2 [06:46]	
MOUSIKOS Nikolas	CYP	20	SHULMAN S. (ISR)	00 s2 / 10 s0 [06:00]	
POSNAKIDIS Theodoros	GRE	20	ATANASOV Y. (BUL)	00 s0 / 10 s0 [00:11]	
IGILIK Margulan	KAZ	21			
DIMITRAKAS Panagiotis	GRE	21			
BACHOSHVILI Shota	GEO	22			
GARAYEV Ilkin	AZE	22			
BENISEK Filip	SRB	23			
SHULMAN Shiloh	ISR	23			
DESPOTIS Nikolaos	GRE	24			
ATANASOV Yuliy	BUL	24			

POOL D

STAVROU Christos	CYP	25	STAVROU C. (CYP)	10 s0 / 00 s0 [01:08]	
BOSEDLAKIDIS Christos	GRE	26	RIZEA T. (ROU)	00 s0 / 02 s0 [01:55]	
RIZEA Tudor	ROU	26	GHEORGHU D. (GBR)	00 s3 / 10 s0 [03:52]	
CHUHNNENKO Roma	ISR	27	DARISPANASHVILI L. (GEO)	10 s0 / 00 s0 [00:10]	
GHEORGHU David	GBR	27	ALASGAROV Z. (AZE)	00 s1 / 01 s0 [04:00]	
DARISPANASHVILI Luka	GEO	28	ODIKADZE O. (GEO)	00 s0 / 10 s0 [01:13]	
MALERDOS Dimitrios	GRE	28			
TURYSBEK Yerzhanibek	KAZ	29	DIMITROV S. (BUL)	01 s1 / 02 s1 [03:59]	
ALASGAROV Zeyd	AZE	29			
BOSEDLAKIDIS Evangelos	GRE	30			
ODIKADZE Otari	GEO	30			
TZUR Idan	ISR	31			
DIOS Emmanouil	GRE	31			
MOSCIONI Lorenzo	ITA	32			
DIMITROV Samuil	BUL	32			

REPECHAGE

THIRY L. (FRA)	61	THIRY L. (FRA)	65	SHTAIN T. (ISR)	69	SHTAIN T. (ISR)
TEKIN S. (TUR)	62	SHTAIN T. (ISR)	00 s3 / 10 s1 [03:06]	KARIMOV A. (AZE)	10 s2 / 00 s1 [03:26]	
ROTSOS P. (GRE)	62	TEKIN S. (TUR)	00 s2 / 11 s1 [03:24]	TEKIN S. (TUR)	10 s0 / 00 s0 [00:41]	
BACHOSHVILI S. (GEO)	63	MCHEDLISHVILI N. (GEO)	11 s1 / 00 s1 [02:01]	DOSBERGEN N. (KAZ)	01 s0 / 10 s0 [00:59]	
IGILIK M. (KAZ)	63	IGILIK M. (KAZ)				
TURYSBEK Y. (KAZ)	64	ATANASOV Y. (BUL)	00 s1 / 00 s0 [01:30]	IGILIK M. (KAZ)	10 s0 / 00 s3 [03:40]	
ODIKADZE O. (GEO)	64	TURYSBEK Y. (KAZ)	10 s0 / 00 s0 [03:16]	TURYSBEK Y. (KAZ)	01 s2 / 00 s2 [04:00]	
		DIMITROV S. (BUL)		DARISPANASHVILI L. (GEO)		

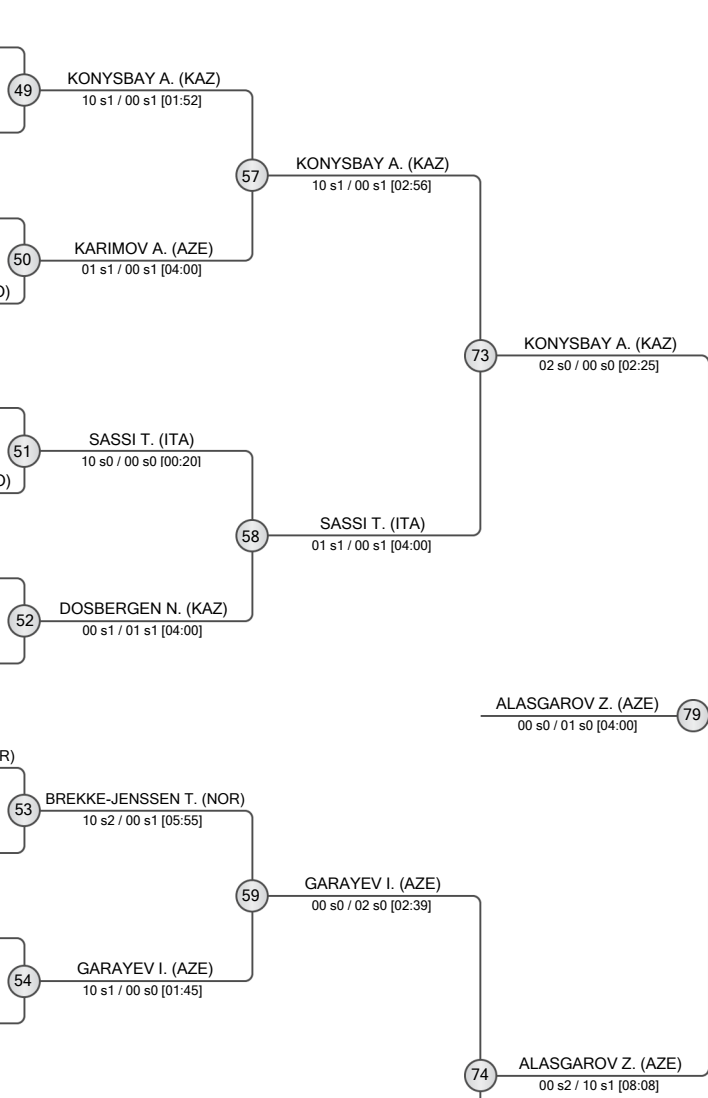

FINAL RESULTS		
1. ALASGAROV Zeyd	AZE	
2. KONYSBAY Altynbek	KAZ	
3. DOSBERGEN Nurdos	KAZ	
3. IGILIK Margulan	KAZ	
5. GARAYEV Ilkin	AZE	
5. SASSI Thomas	ITA	
7. SHTAIN Tomer	ISR	
7. TURYSBEK Yerzhanibek	KAZ	





Thessaloniki Cadet European Cup 2024

Greece, Thessaloniki, 23-24 Nov 2024

-66 kg

Men (52)

POOL A

	SAMADASHVILI Merabi	GEO
	BAIDAVLETOV Kirill	KAZ
	BELLOS Alexandros	GRE
	ANDROUTSOS Konstantinos	GRE
	LAFORGE Yann	FRA
	FRIEDRICH Noam	ISR
	SAHIBZADE Fakhri	AZE
	PRENTZAS Panagiotis	GRE
	SHACHAM Itamar	ISR
	MIRESCU Cristian	ROU
	ZLATKOV Ognjen	SRB
	BENZAKEN Emri	ISR
	MUSTAFOV Ferkan	BUL

1	SAMADASHVILI M. (GEO)	33	SAMADASHVILI M. (GEO)	
2	BAIDAVLETOV K. (KAZ)	01 s2 / 00 s2 [11:38]	10 s0 / 00 s0 [01:40]	
3	LAFORGE Y. (FRA)	00 s0 / 10 s0 [01:45]	34	FRIEDRICH N. (ISR)
4	FRIEDRICH N. (ISR)	00 s1 / 02 s0 [03:10]	49	FRIEDRICH N. (ISR)
5	SAHIBZADE F. (AZE)	35	SAHIBZADE F. (AZE)	
6	SHACHAM I. (ISR)	00 s0 / 11 s0 [01:08]	50	SAHIBZADE F. (AZE)
7	MIRESCU C. (ROU)	11 s1 / 01 s0 [03:03]	36	MIRESCU C. (ROU)
8	BENZAKEN E. (ISR)	01 s0 / 00 s1 [04:13]	10 s0 / 00 s0 [00:58]	

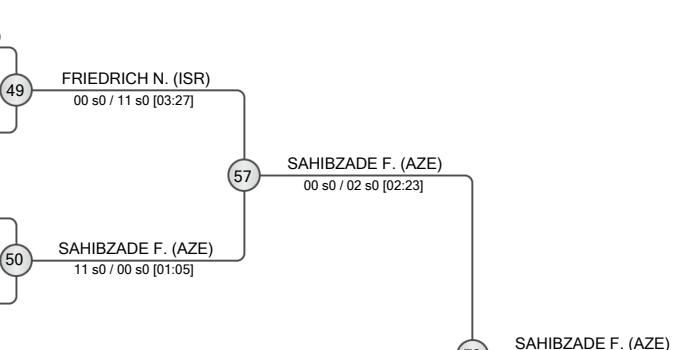

POOL B

	GUBBERUD Nino	NOR
	SEGAL Itamar	ISR
	SANDLERMAN Artur	POL
	MAMPENTZIDIS Georgios	GRE
	HERTA David	MDA
	LIVNI Ollie	ISR
	ATANASOV Kristiyan	BUL
	HADZI-VELJKOVIC Nikola	CRO
	BORCHASHVILI Chinig	GEO
	TZAMALIS Anastasios	GRE
	HADJISAVVAS Georgios	CYP
	BRUZHANITSKY Tal	ISR
	NIKOLOV Preslav	BUL

9	GUBBERUD N. (NOR)	37	SANDLERMAN A. (POL)	
10	SANDLERMAN A. (POL)	00 s0 / 02 s1 [01:38]	01 s0 / 02 s1 [03:51]	
11	HERTA D. (MDA)	00 s1 / 10 s0 [00:33]	38	HERTA D. (MDA)
12	ATANASOV K. (BUL)	00 s1 / 01 s0 [04:00]	10 s0 / 00 s0 [00:20]	
13	HADZI-VELJKOVIC N. (CRO)	39	BORCHASHVILI C. (GEO)	
14	BORCHASHVILI C. (GEO)	10 s0 / 00 s0 [00:47]	52	BORCHASHVILI C. (GEO)
15	BRUZHANITSKY T. (ISR)	00 s1 / 10 s0 [01:30]	40	BRUZHANITSKY T. (ISR)
16	NIKOLOV P. (BUL)	01 s2 / 00 s0 [04:00]		

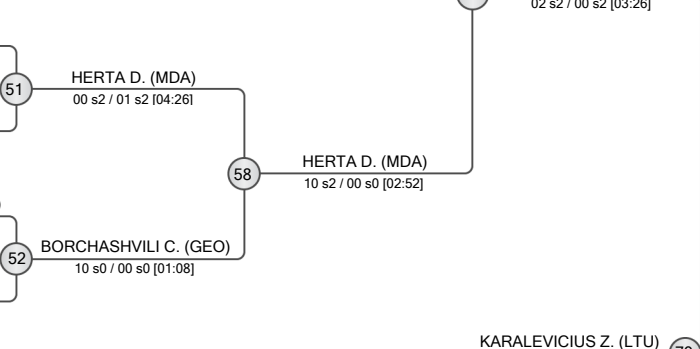

POOL C

	SEGA David	CRO
	PEPPOS Aimilios	CYP
	HAVIVI Omer	ISR
	BREGVADZE Nika	GEO
	GAVRILIS Michail Angelos	GRE
	DIMITROV Kristiyan	BUL
	SPANOS Georgios	GRE
	MOR Golan	ISR
	TRANDAFIR Adrian	ROU
	GAL Kristof	HUN
	GULIYEV Ozgan	AZE
	RALLIS Aggelos	GRE
	MEHAT Gabriel	FRA

17	SEGA D. (CRO)	41	SEGA D. (CRO)	
18	HAVIVI O. (ISR)	00 s1 / 10 s0 [01:25]	10 s1 / 00 s2 [02:44]	
19	BREGVADZE N. (GEO)	02 s2 / 00 s2 [03:42]	42	BREGVADZE N. (GEO)
20	DIMITROV K. (BUL)	11 s1 / 00 s0 [03:41]	53	BREGVADZE N. (GEO)
21	SPANOS G. (GRE)	43	SPANOS G. (GRE)	
22	TRANDAFIR A. (ROU)	00 s0 / 10 s1 [02:14]	54	GULIYEV O. (AZE)
23	GULIYEV O. (AZE)	00 s0 / 02 s0 [02:22]	44	GULIYEV O. (AZE)
24	MEHAT G. (FRA)	00 s0 / 10 s0 [02:12]	02 s0 / 00 s0 [01:30]	

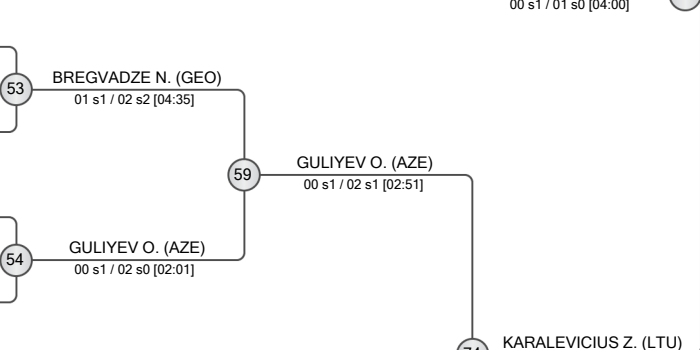

POOL D

	KARALEVICIUS Zygimantas	LTU
	BAR Yuval	ISR
	WARDE JONES Ben	LUX
	TODOROV Nikolay	BUL
	KALIFATIDIS Georgios	GRE
	SHVARTZ Yanir	ISR
	ALAKBAROV Aykhan	AZE
	BABACHEV Stiliyan	BUL
	FILIPOVIC Nenad	SRB
	TVALIASHVILI Daviti	GEO
	PAPADOPOULOS Nikolaos	GRE
	BANDEIRA Toan	FRA
	MIYARA Yuval	ISR

25	KARALEVICIUS Z. (LTU)	45	KARALEVICIUS Z. (LTU)	
26	BAR Y. (ISR)	02 s0 / 00 s0 [00:39]	10 s0 / 00 s0 [00:45]	
27	TODOROV N. (BUL)	02 s0 / 00 s0 [01:02]	46	ALAKBAROV A. (AZE)
28	ALAKBAROV A. (AZE)	00 s2 / 11 s0 [02:01]	00 s0 / 11 s1 [03:58]	
29	BABACHEV S. (BUL)	47	BABACHEV S. (BUL)	
30	TVALIASHVILI D. (GEO)	00 s0 / 10 s0 [01:30]	10 s0 / 00 s0 [00:49]	
31	BANDEIRA T. (FRA)	00 s0 / 11 s0 [00:26]	56	BABACHEV S. (BUL)
32	MIYARA Y. (ISR)	00 s0 / 10 s1 [03:05]	48	MIYARA Y. (ISR)

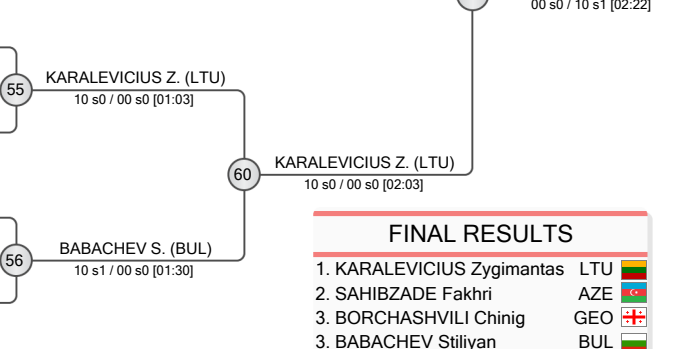

REPECHAGE

61	SHACHAM I. (ISR)	65	SHACHAM I. (ISR)
62	ATANASOV K. (BUL)	66	ATANASOV K. (BUL)
63	GAL K. (HUN)	67	GAL K. (HUN)
64	BAR Y. (ISR)	68	BAR Y. (ISR)

65	MIRESCU C. (ROU)	69	FRIEDRICH N. (ISR)
66	SANDLERMAN A. (POL)	70	BORCHASHVILI C. (GEO)
67	SPANOS G. (GRE)	71	BREGVADZE N. (GEO)
68	ALAKBAROV A. (AZE)	72	BABACHEV S. (BUL)

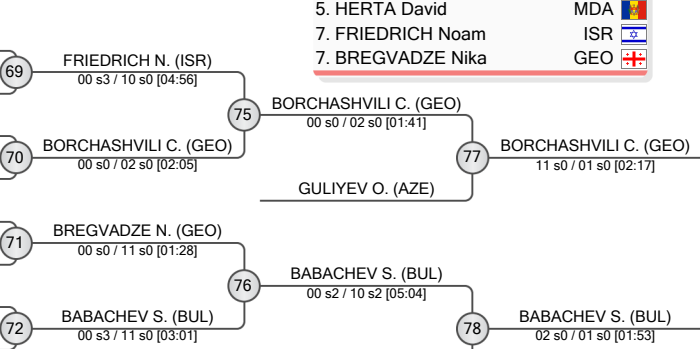

FINAL RESULTS			
1.	KARALEVICIUS Zygimantas	LTU	
2.	SAHIBZADE Fakhri	AZE	
3.	BORCHASHVILI Chinig	GEO	
3.	BABACHEV Stiliyan	BUL	
5.	GULIYEV Ozgan	AZE	
5.	HERTA David	MDA	
7.	FRIEDRICH Noam	ISR	
7.	BREGVADZE Nika	GEO	



POOL A

	KULLO Tits	LAT
	VLAEV Bogdan	BUL
	CHERKAVSKY Maxim	ISR
	SHARIFOV Said	AZE
	PREDA Emanuel	ROU
	GIVISHVILI Giorgi	GEO
	PAVLOVIC Fredi	CRO
	JEREMIC Atanasije	SRB
	KADRIC Denis	BIH
	MIHALEV Nikolaz	BUL
	PETROSSIAN Garry	CYP
	ANDRONOPOULOS Nikolaos	GRE

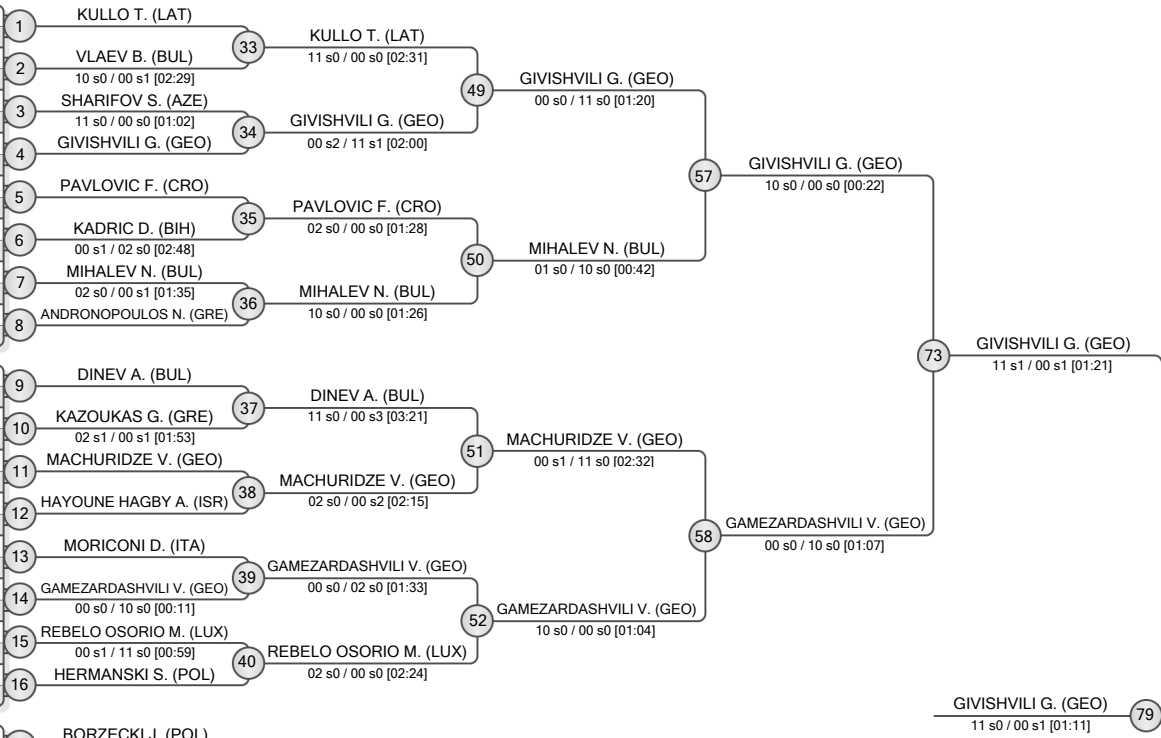

POOL B

	DINEV Aleksandar	BUL
	KAZOUKAS Georgios	GRE
	JUKA Stefan	BIH
	MACHURIDZE Vladimer	GEO
	HAYOUNE HAGBY Avi Shalom	ISR
	MORICONI Daniele	ITA
	PEPPOS Viktoras	CYP
	GAMEZARDASHVILI Vasil	GEO
	PAPADOPOULOS Georgios	GRE
	REBELO OSORIO Marcos	LUX
	HERMANSKI Szymon	POL

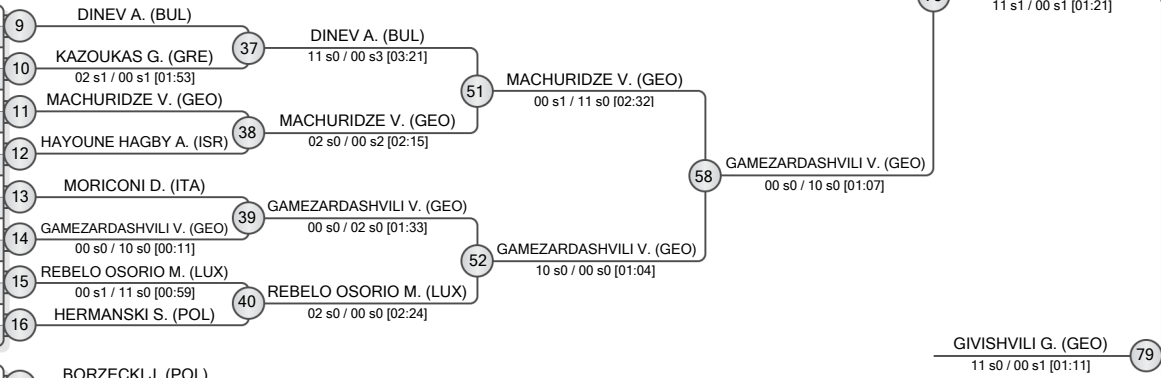

POOL C

	BORZECKI Jakub	POL
	CHARALAMPOUS Vladimiro	CYP
	DJURISIC Balsa	MNE
	DJORDJEVIC Jovan	SRB
	KATRANIDIS Ioannis	GRE
	SULJKANOVIC Ajdin	BIH
	MERCEA David Emanuel	ROU
	ANASTASIADIS Dionysios	GRE
	KURDGELASHVILI Nikoloz	GEO
	KAGLATZIS Panagiotis	CYP
	REISFELD Moran	ISR
	GELEV Bozhidar	BUL

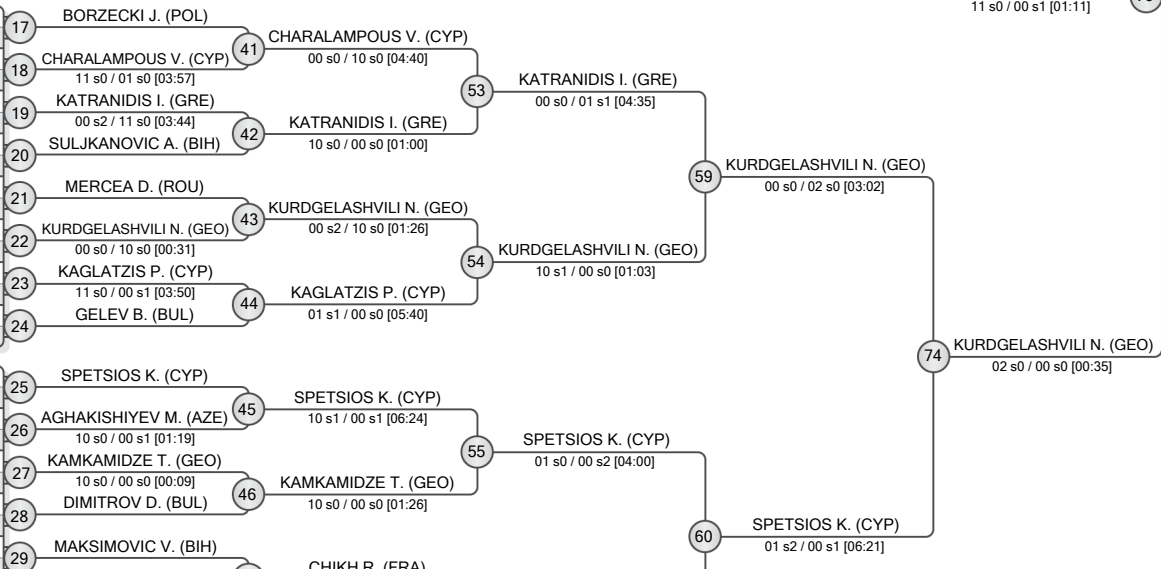

POOL D

	SPETSIOS Kyriakos	CYP
	AGHAKISHIYEV Mahammad	AZE
	DAMIANIDIS Vasileios	GRE
	KAMKAMIDZE Tengiz	GEO
	NATKHO Ryan	ISR
	DIMITROV Dimitar	BUL
	MAKSIMOVIC Vuk	BIH
	CHIKH Riad	FRA
	PERALOVIC Uros	SRB
	GKOLIAS Efthymios	GRE
	SAMSIANI Ieso	GEO
	GAVRAILOV Nikolay	BUL

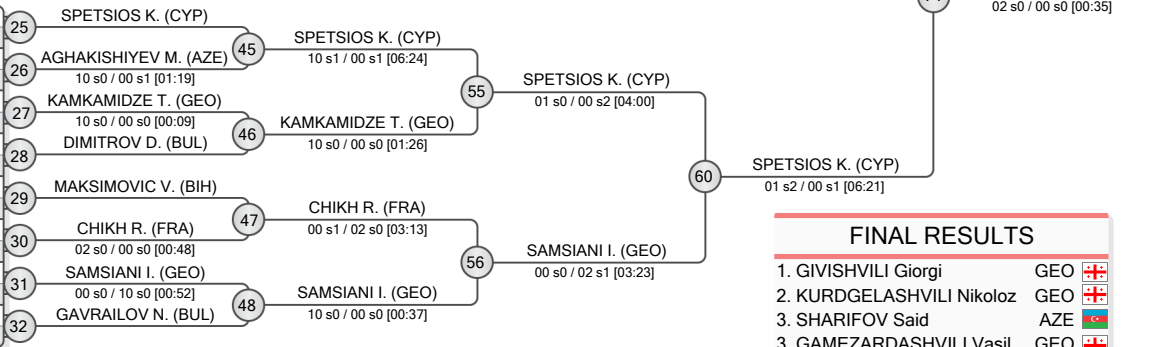

FINAL RESULTS

- GIVISHVILI Giorgi GEO
- KURDGELASHVILI Nikoloz GEO
- SHARIFOV Said AZE
- GAMEZARDASHVILI Vasil GEO
- SPETSIOS Kyriakos CYP
- MERCEA David Emanuel ROU
- MACHURIDZE Vladimer GEO
- AGHAKISHIYEV Mahammad AZE

REPECHAGE

SHARIFOV S. (AZE)	61	SHARIFOV S. (AZE)	65	SHARIFOV S. (AZE)	69	SHARIFOV S. (AZE)	75	SHARIFOV S. (AZE)	77	SHARIFOV S. (AZE)	77	SHARIFOV S. (AZE)	77	SHARIFOV S. (AZE)	77	SHARIFOV S. (AZE)	77
PEPPOS V. (CYP)		KULLO T. (LAT)		MIHALEV N. (BUL)		MIHALEV N. (BUL)		MIHALEV N. (BUL)		MIHALEV N. (BUL)		MIHALEV N. (BUL)		MIHALEV N. (BUL)		MIHALEV N. (BUL)	
MORICONI D. (ITA)	62	PEPPOS V. (CYP)	66	REBELO OSORIO M. (LUX)	70	MACHURIDZE V. (GEO)	76	MACHURIDZE V. (GEO)	76	MACHURIDZE V. (GEO)	76	MACHURIDZE V. (GEO)	76	MACHURIDZE V. (GEO)	76	MACHURIDZE V. (GEO)	76
ANASTASIADIS D. (GRE)		REBELO OSORIO M. (LUX)		MACHURIDZE V. (GEO)		MACHURIDZE V. (GEO)		MACHURIDZE V. (GEO)		MACHURIDZE V. (GEO)		MACHURIDZE V. (GEO)		MACHURIDZE V. (GEO)		MACHURIDZE V. (GEO)	
MERCEA D. (ROU)	63	MERCEA D. (ROU)	67	MERCEA D. (ROU)	71	MERCEA D. (ROU)	77	MERCEA D. (ROU)	77	MERCEA D. (ROU)	77	MERCEA D. (ROU)	77	MERCEA D. (ROU)	77	MERCEA D. (ROU)	77
		KAGLATZIS P. (CYP)		KATRANIDIS I. (GRE)		KATRANIDIS I. (GRE)		KATRANIDIS I. (GRE)		KATRANIDIS I. (GRE)		KATRANIDIS I. (GRE)		KATRANIDIS I. (GRE)		KATRANIDIS I. (GRE)	
AGHAKISHIYEV M. (AZE)	64	AGHAKISHIYEV M. (AZE)	68	AGHAKISHIYEV M. (AZE)	72	AGHAKISHIYEV M. (AZE)	78	AGHAKISHIYEV M. (AZE)	78	AGHAKISHIYEV M. (AZE)	78	AGHAKISHIYEV M. (AZE)	78	AGHAKISHIYEV M. (AZE)	78	AGHAKISHIYEV M. (AZE)	78
		KAMKAMIDZE T. (GEO)		SAMSIANI I. (GEO)		SAMSIANI I. (GEO)		SAMSIANI I. (GEO)		SAMSIANI I. (GEO)		SAMSIANI I. (GEO)		SAMSIANI I. (GEO)		SAMSIANI I. (GEO)	



Thessaloniki Cadet European Cup 2024

Greece, Thessaloniki, 23-24 Nov 2024

-81 kg

Men (38)

POOL A

	MUKHUM Rassul	KAZ	1
	STATHOPOULOS Tryfonas	GRE	2
	ORFANOS Athanasios	CYP	3
	ZOARETZ Tomer	ISR	4
	SOLHAUG Fredrik Holm	NOR	5
	MOGILNI Kirill	ISR	6
	TCHENDJE KENMEUE Arthur	FRA	7
	BOUKOUVALAS Agathoklis-Aris	GRE	8
	RAHMATOV Abdullah	AZE	9
	KATSARSKI Teodor	BUL	10

1	MUKHUM R. (KAZ)	33	MUKHUM R. (KAZ)	
2	ORFANOS A. (CYP)	00 s0 / 10 s0 [02:16]	11 s0 / 00 s0 [02:07]	
3	ZOARETZ T. (ISR)	34	SOLHAUG F. (NOR)	
4	SOLHAUG F. (NOR)	00 s0 / 10 s0 [00:11]	49	MUKHUM R. (KAZ)
5	MOGILNI K. (ISR)	35	MOGILNI K. (ISR)	
6	TCHENDJE KENMEUE A. (FRA)	02 s0 / 00 s0 [00:40]	50	RAHMATOV A. (AZE)
7	RAHMATOV A. (AZE)	00 s0 / 10 s0 [01:00]	36	RAHMATOV A. (AZE)
8	KATSARSKI T. (BUL)	10 s0 / 00 s0 [00:45]	57	MUKHUM R. (KAZ)
			02 s0 / 00 s0 [01:09]	

57	MUKHUM R. (KAZ)	73	MUKHUM R. (KAZ)
	02 s0 / 00 s0 [01:09]		10 s1 / 00 s1 [02:01]

POOL B

	BUMAZKINS Jelisejs	LAT	9
	MARKOVIC Matija	MNE	10
	NTAVITANTZE Loukas	GRE	11
	MAN Darius	ROU	12
	ABBASALI Mahammad	AZE	13
	GELASHVILI Levan	GEO	14
	SHNIDER Omer	ISR	15
	GIANNAKOS Dimitrios	GRE	16
	SARGHEOLIU Alexandru	MDA	17

9	BUMAZKINS J. (LAT)	37	BUMAZKINS J. (LAT)	
10	MARKOVIC M. (MNE)	11 s0 / 00 s3 [01:40]	01 s0 / 00 s0 [04:00]	
11	NTAVITANTZE Loukas	38	MAN D. (ROU)	
12	ABBASALI M. (AZE)	02 s1 / 00 s0 [01:45]	51	BUMAZKINS J. (LAT)
13	GELASHVILI L. (GEO)	39	GELASHVILI L. (GEO)	
14	SHNIDER O. (ISR)	01 s1 / 00 s0 [06:11]	52	GELASHVILI L. (GEO)
15	GIANNAKOS D. (GRE)	40	SARGHEOLIU A. (MDA)	
16	SARGHEOLIU A. (MDA)	00 s0 / 00 s0 [00:00]	58	BUMAZKINS J. (LAT)
			10 s0 / 00 s3 [05:19]	

58	BUMAZKINS J. (LAT)	79	MUKHUM R. (KAZ)
	10 s0 / 00 s3 [05:19]		01 s1 / 00 s1 [04:00]

POOL C

	BABAICENKO Tajus	LTU	17
	LARIOS Anastasios	GRE	18
	FOGEL Alon	ISR	19
	BAKHTADZE Tsotne	GEO	20
	CHARALAMPOUS Miltiadis	CYP	21
	GARAGAU Razvan	ROU	22
	TSANTEKOV Achilles	GRE	23
	AYDOGU Mehmet Ali	TUR	24
	NIANE Elias	NOR	25

17	BABAICENKO T. (LTU)	41	BABAICENKO T. (LTU)	
18	LARIOS A. (GRE)	11 s0 / 00 s0 [00:20]	53	BABAICENKO T. (LTU)
19	FOGEL A. (ISR)	42	BAKHTADZE T. (GEO)	
20	BAKHTADZE T. (GEO)	00 s0 / 10 s0 [00:40]	54	NIANE E. (NOR)
21	CHARALAMPOUS M. (CYP)	43	CHARALAMPOUS M. (CYP)	
22	GARAGAU R. (ROU)	01 s2 / 00 s1 [05:40]	59	BABAICENKO T. (LTU)
23	TSANTEKOV A. (GRE)	44	NIANE E. (NOR)	
24	NIANE E. (NOR)	00 s1 / 10 s2 [03:47]	60	MEHDIYEV A. (AZE)
			00 s3 / 10 s0 [01:04]	

59	BABAICENKO T. (LTU)	74	BABAICENKO T. (LTU)
	10 s0 / 00 s0 [01:11]		10 s1 / 00 s1 [05:59]

POOL D

	JACENKO Arturs	LAT	25
	MLADENOVIC Andrija	SRB	26
	BOUNTANIOTIS Georgios	GRE	27
	LAZAROV Ventsislav	BUL	28
	ACHLOW Boaz	ISR	29
	CAPEZZUTO Antonio	ITA	30
	NAPSO Aslan	ISR	31
	IAKOVOU Michalis	CYP	32
	MEHDIYEV Amin	AZE	33
	BESTAEV Dionysis	GRE	34

25	JACENKO A. (LAT)	45	JACENKO A. (LAT)	
26	MLADENOVIC A. (SRB)	01 s0 / 00 s1 [04:38]	55	JACENKO A. (LAT)
27	BOUNTANIOTIS G. (GRE)	10 s0 / 00 s0 [01:34]	56	MEHDIYEV A. (AZE)
28	LAZAROV Ventsislav	46	BOUNTANIOTIS G. (GRE)	
29	ACHLOW B. (ISR)	10 s0 / 00 s0 [00:27]	60	MEHDIYEV A. (AZE)
30	CAPEZZUTO A. (ITA)	47	NAPSO A. (ISR)	
31	NAPSO A. (ISR)	00 s0 / 01 s0 [04:21]	69	RAHMATOV A. (AZE)
32	IAKOVOU Michalis	48	MEHDIYEV A. (AZE)	
33	MEHDIYEV A. (AZE)	10 s0 / 00 s0 [02:03]	75	RAHMATOV A. (AZE)
34	BESTAEV D. (GRE)	61	ORFANOS A. (CYP)	
			10 s0 / 00 s0 [04:00]	

60	MEHDIYEV A. (AZE)	77	MEHDIYEV A. (AZE)
	00 s3 / 10 s0 [01:04]		00 s3 / 10 s0 [04:41]

FINAL RESULTS	
1.	MUKHUM Rassul KAZ
2.	BABAICENKO Tajus LTU
3.	MEHDIYEV Amin AZE
4.	BAKHTADZE Tsotne GEO
5.	RAHMATOV Abdullah AZE
6.	BUMAZKINS Jelisejs LAT
7.	GELASHVILI Levan GEO
8.	NAPSO Aslan ISR

REPECHAGE

61	ORFANOS A. (CYP)	65	SOLHAUG F. (NOR)
62	MARKOVIC M. (MNE)	66	MARKOVIC M. (MNE)
63	LARIOS A. (GRE)	67	BAKHTADZE T. (GEO)
64	BESTAEV D. (GRE)	68	NAPSO A. (ISR)

65	ORFANOS A. (CYP)	69	RAHMATOV A. (AZE)
66	MARKOVIC M. (MNE)	70	GELASHVILI L. (GEO)
67	BAKHTADZE T. (GEO)	71	BAKHTADZE T. (GEO)
68	NAPSO A. (ISR)	72	NAPSO A. (ISR)

69	RAHMATOV A. (AZE)	75	RAHMATOV A. (AZE)
	00 s0 / 10 s0 [00:42]		02 s0 / 00 s1 [01:55]
70	GELASHVILI L. (GEO)	77	MEHDIYEV A. (AZE)
	00 s1 / 02 s2 [03:23]		00 s3 / 10 s0 [04:41]
71	BAKHTADZE T. (GEO)	76	BAKHTADZE T. (GEO)
	02 s0 / 00 s1 [03:38]		02 s0 / 00 s0 [02:03]
72	NAPSO A. (ISR)	78	BAKHTADZE T. (GEO)
	02 s0 / 01 s0 [03:59]		01 s0 / 00 s0 [04:00]





Thessaloniki Cadet European Cup 2024

Greece, Thessaloniki, 23-24 Nov 2024

-90 kg

Men (21)

POOL A

	KONCILIJIA Dan	CRO
	SIMON Viktor	MNE
	PRENTZAS Pavlos	GRE
	PRUIDZE Saba	GEO
	GAL Ofri	ISR
	VALENTIN Jeremy	LUX

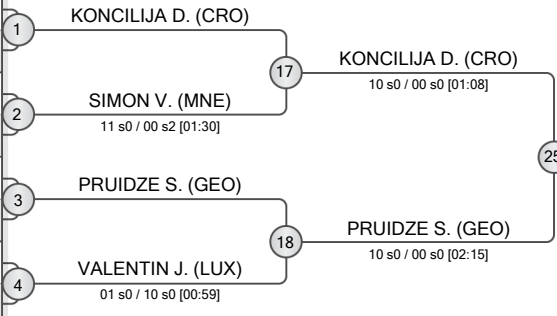

POOL B

	VUJICA Marko	CRO
	NAZLIS Dimitrios	GRE
	STANEV Zdravko	BUL
	DJINKIC Ivano	BIH
	SHOSHIN Nikita	IJF

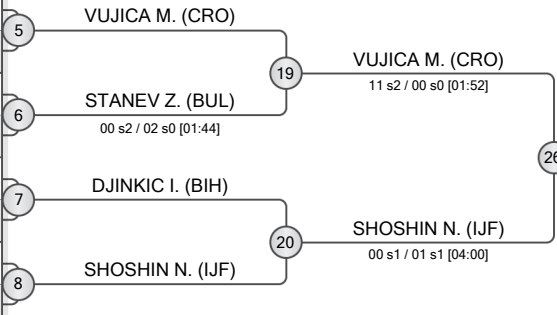

POOL C

	MILICEVIC Ivan	BIH
	RADULOVIC Jovan	MNE
	PASZEK Damian	POL
	HUSEYNOV Said	AZE
	KARAKLIDIS Gkiorgki	GRE

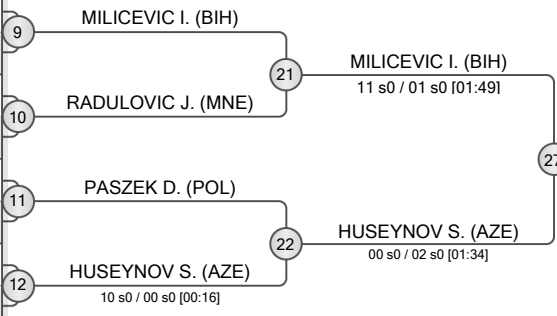

POOL D

	SIMIC Nemanja	SRB
	TZAGKIDIS Nikolaos	GRE
	SUNDBY Marius	NOR
	JURILJ Simun	CRO
	NEACSU Rares	ROU

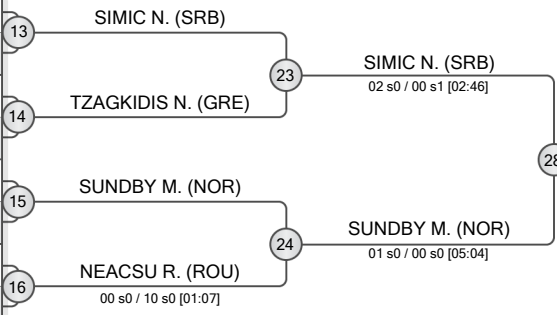

REPECHAGE

	SIMON V. (MNE)	29	SIMON V. (MNE)	33
	DJINKIC I. (BIH)	30	DJINKIC I. (BIH)	34
	RADULOVIC J. (MNE)	31	RADULOVIC J. (MNE)	35
	TZAGKIDIS N. (GRE)	32	TZAGKIDIS N. (GRE)	36

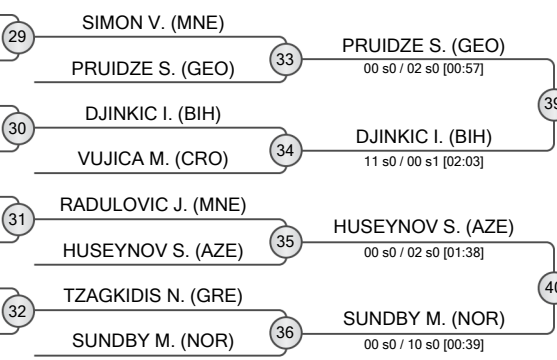

FINAL RESULTS	
1.	SHOSHIN Nikita IJF
2.	MILICEVIC Ivan BIH
3.	DJINKIC Ivano BIH
3.	SUNDBY Marius NOR
5.	SIMIC Nemanja SRB
5.	KONCILIJIA Dan CRO
7.	PRUIDZE Saba GEO
7.	HUSEYNOV Said AZE





Thessaloniki Cadet European Cup 2024

Greece, Thessaloniki, 23-24 Nov 2024

+ 90 kg

Men (12)

POOL A

	AKHUNDOV Subhan	AZE
	BAZARKATOV Yeraly	KAZ
	CUIBUS Raul	ROU

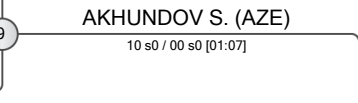
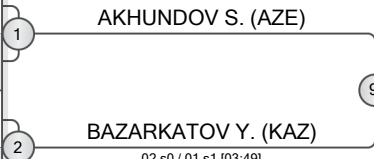

POOL B

	CORKOVIC Filip	SRB
	MASIMOV Javidan	AZE
	GULARASHVILI Viktor	GRE

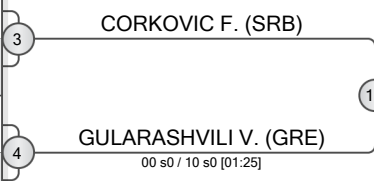

POOL C

	IVANKOVIC Luka	CRO
	ZARAFONITIS Alexios-Paisios	GRE
	FARZALIYEV Tunar	AZE

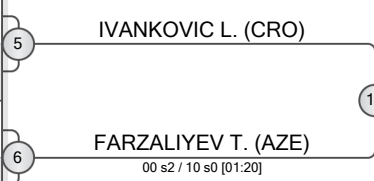

POOL D

	NOVAKOVIC Petar	SRB
	ZHAUDINOV Adilzhan	KAZ
	MALJEVIC Emir	MNE

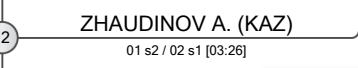
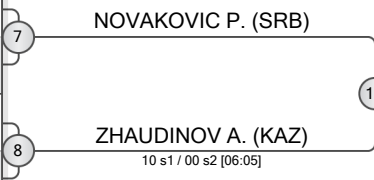

FINAL RESULTS		
1.	AKHUNDOV Subhan	AZE
2.	IVANKOVIC Luka	CRO
3.	ZHAUDINOV Adilzhan	KAZ
5.	BAZARKATOV Yeraly	KAZ
5.	CORKOVIC Filip	SRB
7.	GULARASHVILI Viktor	GRE
7.	NOVAKOVIC Petar	SRB

REPECHAGE

13	BAZARKATOV Y. (KAZ)
14	GULARASHVILI V. (GRE)
15	FARZALIYEV T. (AZE)
16	MALJEVIC E. (MNE)
16	NOVAKOVIC P. (SRB)

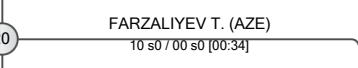
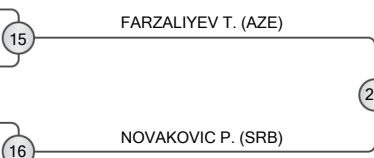
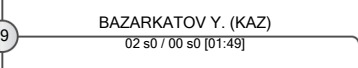
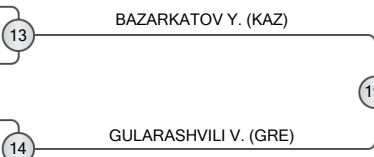



Thessaloniki Cadet European Cup 2024

Greece, Thessaloniki, 23-24 Nov 2024

-44 kg

Women (15)

POOL A

	GABAY Yuval	ISR
	VASILEVA Raya	BUL
	FERRO Aurora	ITA

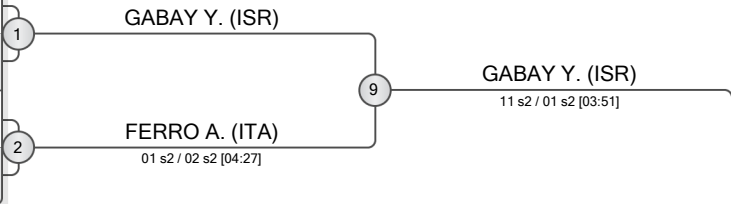

POOL B

	CONI Sara	GBR
	TOKMAK Havva Sena	TUR
	TSOTSKOLAURI Khatia	GEO
	COSTESCU Sabryna	ROU

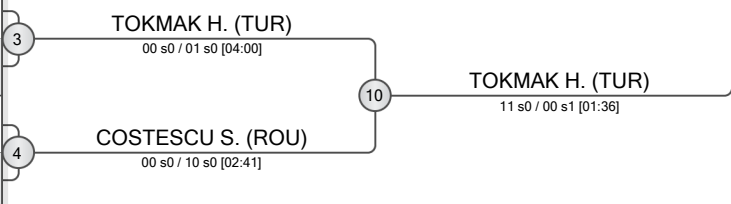

POOL C

	SERBAN Denisa	ROU
	VASILEVA Ema	BUL
	BASAK Vuslat	TUR
	AUREL Mathilde	FRA

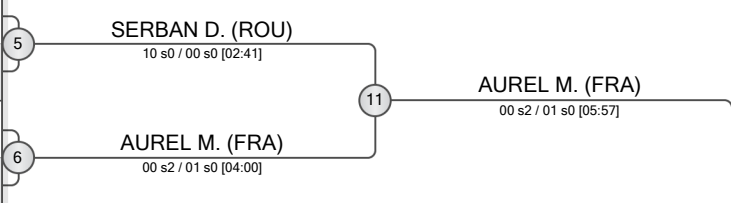

POOL D

	IASHVILI Natali	GEO
	MEKI Fatma Zehra	TUR
	LONGO Sofia	ITA
	CHRISTOFOROU Christina	CYP

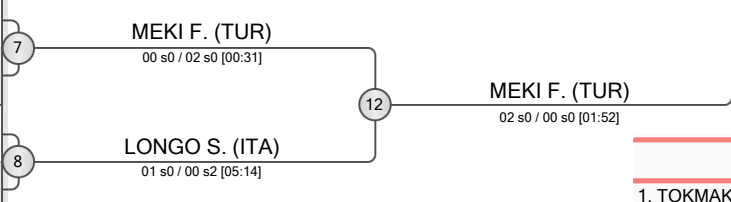

FINAL RESULTS		
1.	TOKMAK Havva Sena	TUR
2.	MEKI Fatma Zehra	TUR
3.	AUREL Mathilde	FRA
3.	GABAY Yuval	ISR
5.	CONI Sara	GBR
5.	SERBAN Denisa	ROU
7.	FERRO Aurora	ITA
7.	LONGO Sofia	ITA

REPECHAGE

13	FERRO A. (ITA)
14	CONI S. (GBR)
15	SERBAN D. (ROU)
16	LONGO S. (ITA)

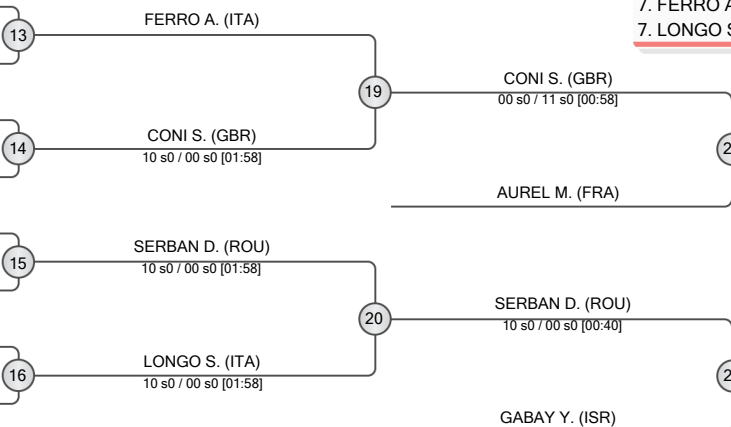



Thessaloniki Cadet European Cup 2024

Greece, Thessaloniki, 23-24 Nov 2024

-48 kg

Women (27)

POOL A

	HERTA Gabriela	MDA
	RUSLANOVA Assel	KAZ
	CHAIYOU Konstantina	GRE
	MILHAVET Agathe	FRA
	BLAZHESKA Georgina	MKD
	PANTSKHAVA Nini	GEO
	KOVACHEVA Preslava	BUL

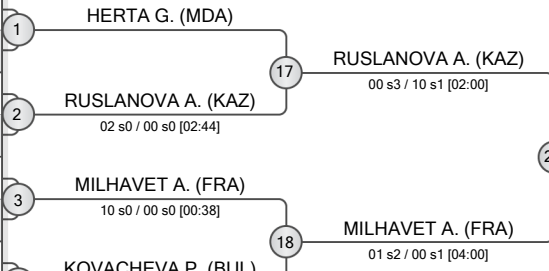

POOL B

	CULJAK Petra	BIH
	MARKOU Maria Eleni	GRE
	ERCIN Rahime	TUR
	BROVOLD Selma	NOR
	MUNTEANU Ana Maria	ROU
	PAPATHEODOROU Evangelia	GRE

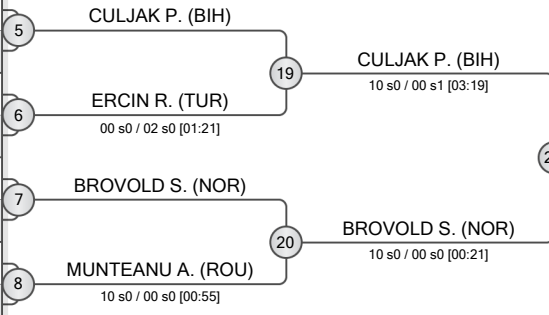

POOL C

	SHYNGGYSKHAN Gul Khan	KAZ
	IDDIR Celine	FRA
	STAVROPOULOU Iliana	GRE
	CHRISP Taylor	GBR
	ANTOVA Zoya	BUL
	STOJMILOVSKA Anamarija	MKD
	NESHER Zimri	ISR

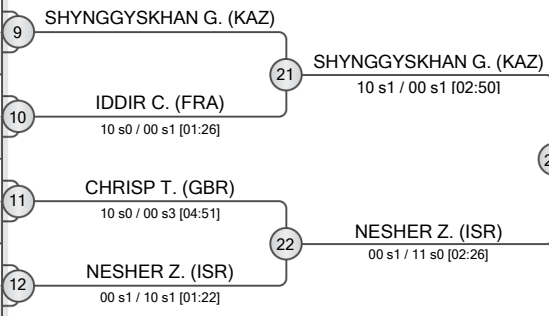

POOL D

	PODYMSKA Nina	POL
	RASIC Mara	SRB
	ANVAROVA Aidana	KAZ
	LETONIA Dora	CRO
	GRIGOROVA Kalina	BUL
	AMAXOPOULOU Nina	GRE
	VANDAELE Aiana	FRA

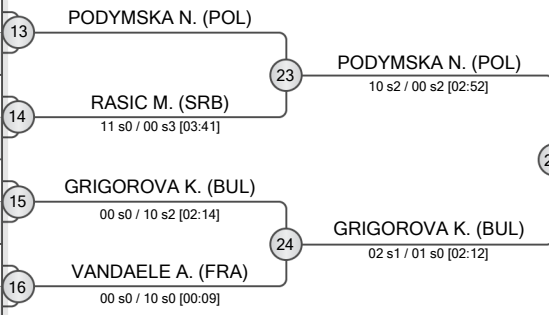

REPECHAGE

CHAIYOU K. (GRE)	29	CHAIYOU K. (GRE)	33
HERTA G. (MDA)		MILHAVET A. (FRA)	
ERCIN R. (TUR)	30	ERCIN R. (TUR)	34
IDDIR C. (FRA)	31	IDDIR C. (FRA)	35
RASIC M. (SRB)	32	RASIC M. (SRB)	36

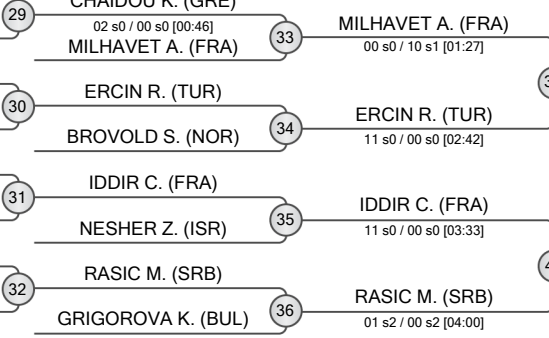

SHYNGGYSKHAN G. (KAZ) 43
00 s1 / 02 s1 [03:33]

SHYNGGYSKHAN G. (KAZ) 38
10 s0 / 00 s2 [03:45]

FINAL RESULTS	
1. SHYNGGYSKHAN Gul Khan	KAZ
2. RUSLANOVA Assel	KAZ
3. MILHAVET Agathe	FRA
3. IDDIR Celine	FRA
5. PODYMSKA Nina	POL
5. CULJAK Petra	BIH
7. ERCIN Rahime	TUR
7. RASIC Mara	SRB





Thessaloniki Cadet European Cup 2024

Greece, Thessaloniki, 23-24 Nov 2024

-52 kg

Women (25)

POOL A

	SAVIC Bojana	SRB
	LOPEZ Alice	FRA
	LO TUFO Ilenia	ITA
	TEISANU Teodora	ROU
	TZAMPARLI Maria	GRE
	ASHKENAZI Shay	ISR
	BILBA Victoria	MDA

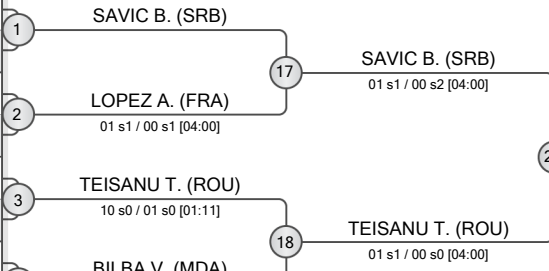

POOL B

	DI LEONARDO Noemi	ITA
	TOMESCU Yasmine	ROU
	TODOROVIC Andjela	SRB
	YAHAV Yali	ISR
	KOYAK Aleyna Sena	TUR
	JURAS Nala	CRO

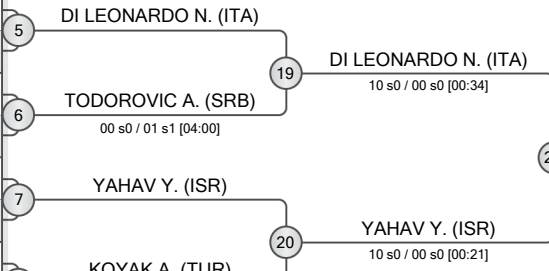

POOL C

	TATRISHVILI Sopio	GEO
	KANELLOPOULOU Aikaterini	GRE
	STOEVA Andrea	BUL
	FIROTTI Chiara	ITA
	KUBERSKY Lia	ISR
	RAIC Gabriela	BIH

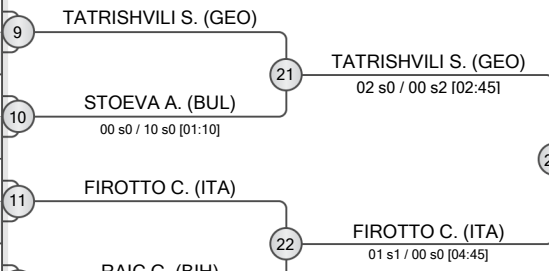

POOL D

	HAMDAOUI Dina-Syrine	FRA
	DIAS Kiara	LUX
	IATAGAN Maria	ROU
	PAPADOPOULOU Eirini-Kleio	GRE
	BRODALA Helena	POL
	SIMIC Andjela	SRB

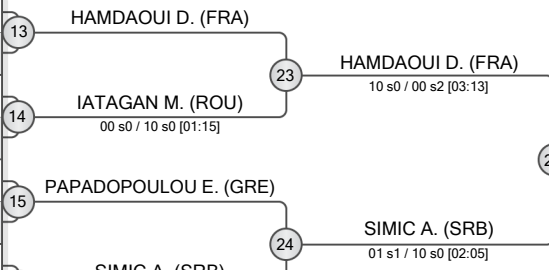

REPECHAGE

LOPEZ A. (FRA)	29	LOPEZ A. (FRA)	33
KOYAK A. (TUR)	30	DI LEONARDO N. (ITA)	34
STOEVA A. (BUL)	31	FIROTTI C. (ITA)	35
IATAGAN M. (ROU)	32	IATAGAN M. (ROU)	36

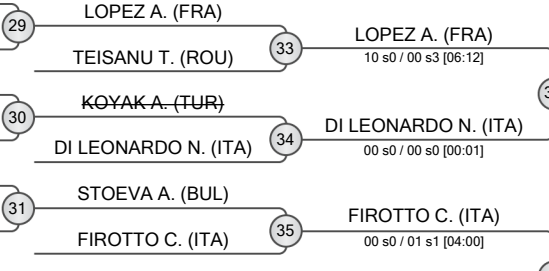

FINAL RESULTS	
1. SAVIC Bojana	SRB
2. TATRISHVILI Sopio	GEO
3. LOPEZ Alice	FRA
3. YAHAV Yali	ISR
5. HAMDAOUI Dina-Syrine	FRA
5. FIROTTI Chiara	ITA
7. IATAGAN Maria	ROU





Thessaloniki Cadet European Cup 2024

Greece, Thessaloniki, 23-24 Nov 2024

-57 kg

Women (30)

POOL A

	SORELLI Giulia	ITA
	KOVACI Krista	ALB
	KADIC Ira	CRO
	GLIGA Ana	ROU
	HADAR Noa	ISR
	DAVAZE Isaure	FRA
	KESIDOU Christina	GRE

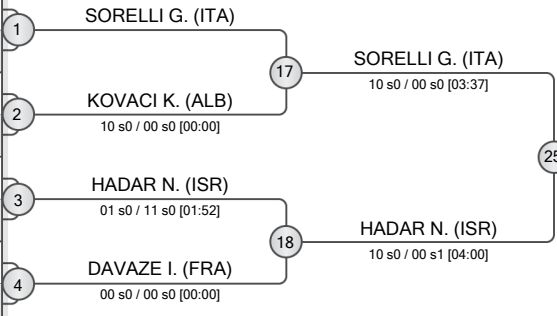

POOL B

	AZINOU Marina	CYP
	KRAUS Daria	ROU
	PAPADOPOULOU Despoina	GRE
	TRAAVIK Asal	NOR
	DUDKO Aleksandra	GBR
	CVETKOVIC Jana	SRB
	GAMIASHVILI Tamar	GEO
	CESLAUSKAITE Deimante	LTU

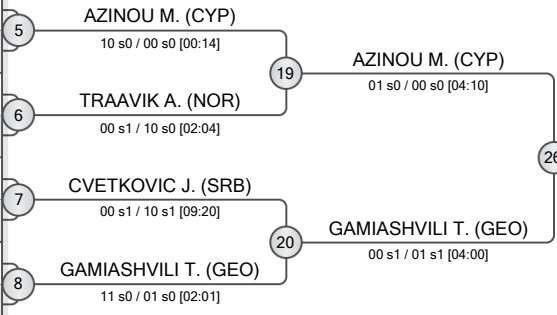

POOL C

	CAPEZZUTO Martina	ITA
	JASIKOVAC Nikolina	BIH
	CHRISTOPOULOU Evdokia	GRE
	PKHAKADZE Barbara	GEO
	TRIFKOVIC Iva	SRB
	PERY Noa	ISR
	REVEILLON Louanne	FRA

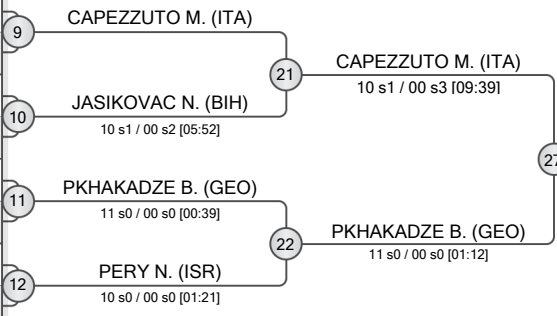

POOL D

	VEINHANDL OBAID Haya	SLO
	KAKARANTZA Ioanna	GRE
	STAIKU Patricia	ROU
	DOS REIS Constance	FRA
	SKOMERSIC Maria	CRO
	SEKULOVIC Milena	SRB
	KHEGAY Kira	KAZ
	BESTAV Selin	TUR

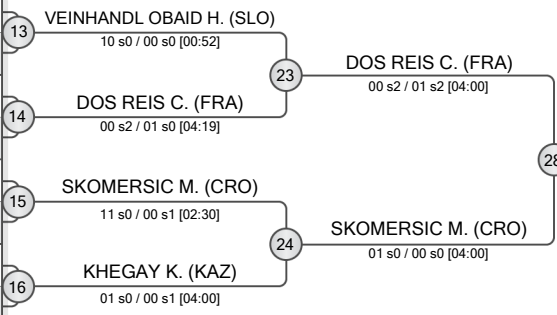

REPECHAGE

GLIGA A. (ROU)	29	GLIGA A. (ROU)	33
DAVAZE I. (FRA)		SORELLI G. (ITA)	
CESLAUSKAITE D. (LTU)	30	CESLAUSKAITE D. (LTU)	34
CVETKOVIC J. (SRB)		AZINOU M. (CYP)	
JASIKOVAC N. (BIH)	31	JASIKOVAC N. (BIH)	35
SEKULOVIC M. (SRB)		PKHAKADZE B. (GEO)	
KHEGAY K. (KAZ)	32	KHEGAY K. (KAZ)	36
		DOS REIS C. (FRA)	

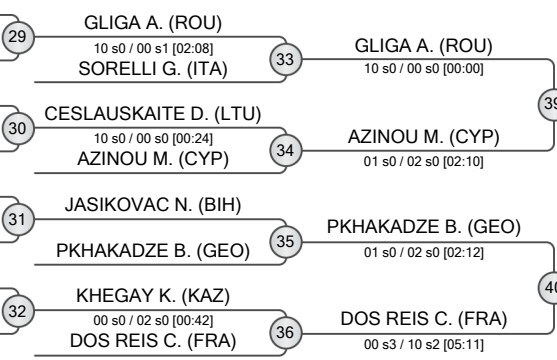

FINAL RESULTS	
1.	CAPEZZUTO Martina ITA
2.	GAMIASHVILI Tamar GEO
3.	AZINOU Marina CYP
3.	DOS REIS Constance FRA
5.	SKOMERSIC Maria CRO
7.	HADAR Noa ISR
7.	GLIGA Ana ROU
7.	PKHAKADZE Barbara GEO





Thessaloniki Cadet European Cup 2024

Greece, Thessaloniki, 23-24 Nov 2024

-63 kg

Women (25)

POOL A

	MATSIRIDI Sophia	GRE
	UNGUREANU Bianca	ROU
	HUBERT Prisca	FRA
	IMERI Sara	CRO
	RUBANOVICI Dorina	MDA
	CHRISAKI Anni-Iris	GRE
	COVIC STANIC Lana	BIH

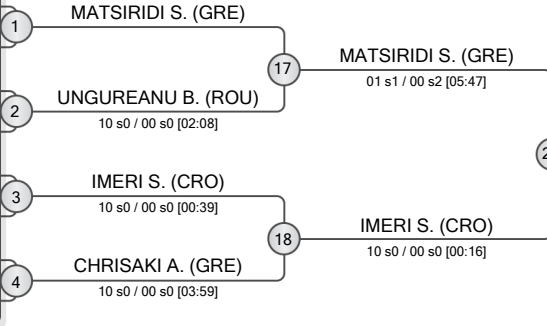

POOL B

	BOGDANOVSKA Iva	MKD
	MATSIRIDI Drosia	GRE
	JOVICIC Sofija	SRB
	THOMSON Maia	CAN
	MITEVA Elizabeth	BUL
	PAPASTERGIOU Anna	GRE

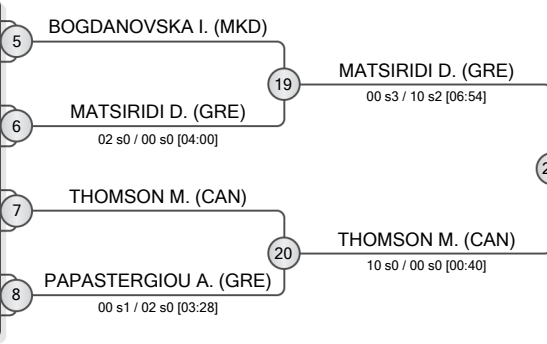

POOL C

	NATELAURI Mariam	GEO
	DIALLO Malika	FRA
	IMERI Esra	CRO
	GRAMBO Anna	NOR
	DOUROU Lydia	GRE
	FROSONI Giorgia	ITA

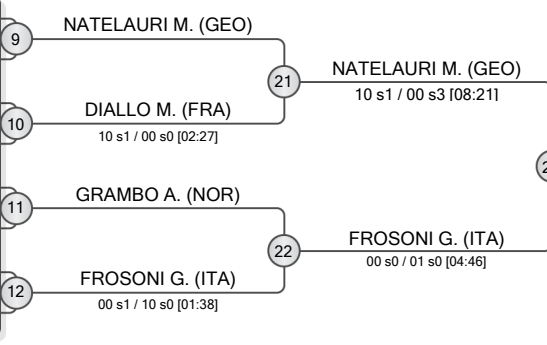

POOL D

	DALMASSO Madeleine	FRA
	OURANITSA Chrysoula-Stavroura	GRE
	TODOROVA Elitsa	BUL
	AUBERT GOMEZ Maya	GBR
	AKRIVOULI Efthymia	GRE
	LULEDZIJA Marija	BIH

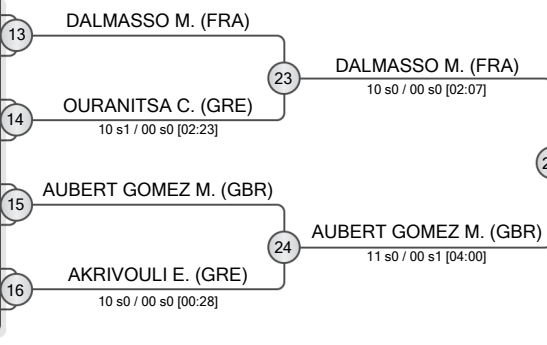

REPECHAGE

RUBANOVICI D. (MDA)	29 CHRSIAKI A. (GRE) [00 s0 / 02 s0] [01:03]
CHRISAKI A. (GRE)	30 PAPASTERGIOU A. (GRE)
PAPASTERGIOU A. (GRE)	31 GRAMBO A. (NOR)
DOUROU L. (GRE)	32 OURANITSA C. (GRE)
GRAMBO A. (NOR)	33 MATSIRIDI S. (GRE)
OURANITSA C. (GRE)	34 MATSIRIDI D. (GRE)
	35 GRAMBO A. (NOR)
	36 AUBERT GOMEZ M. (GBR)

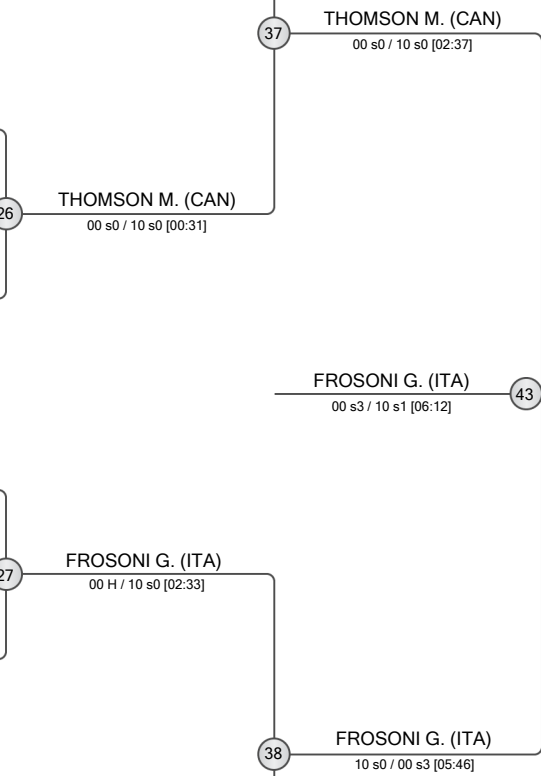
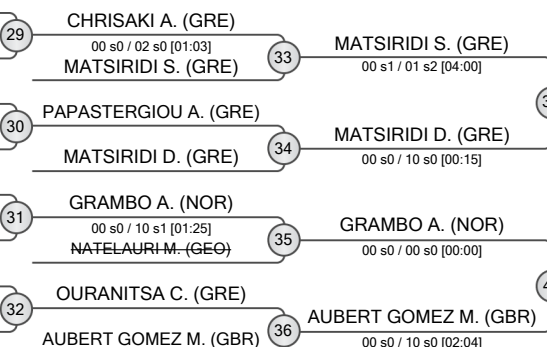

FINAL RESULTS

1. FROSONI Giorgia	ITA
2. THOMSON Maia	CAN
3. DALMASSO Madeleine	FRA
3. AUBERT GOMEZ Maya	GBR
5. MATSIRIDI Sophia	GRE
5. IMERI Sara	CRO
7. MATSIRIDI Drosia	GRE
7. GRAMBO Anna	NOR





Thessaloniki Cadet European Cup 2024

Greece, Thessaloniki, 23-24 Nov 2024

-70 kg

Women (14)

POOL A

	SLACEK Nika	CRO
	PAPAIOANNOU Maria Eleni	GRE
	VLAHOVIC Teodora	MNE

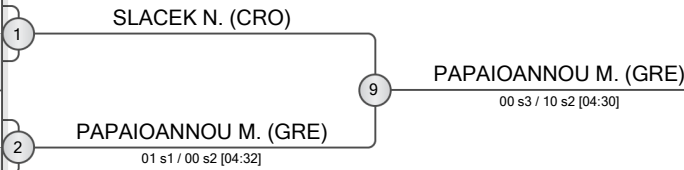

POOL B

	KLINGER Johanna Elisabeth	BIH
	MICHAIL Maria	CYP
	HUDIKA Vita	CRO
	KURDGELIA Elene	GEO

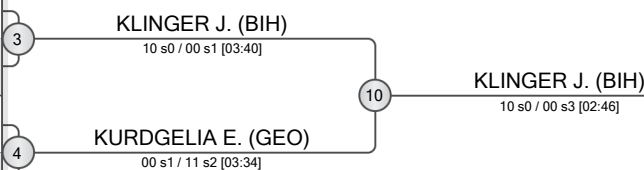

POOL C

	ROBAKIDZE Ket	GEO
	MARKHVAIDZE Lizi	GEO
	KNAFELC Noeli	SLO

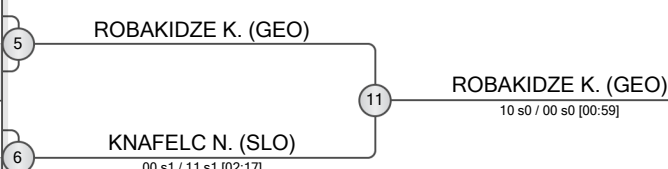

POOL D

	DZIDIC Korina	BIH
	ILIC Sara	SRB
	MITAKIDOU Ilektra-Evangelia	GRE
	APETREI Marianne Alexandra	ITA

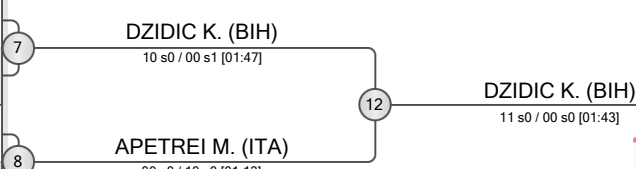

REPECHAGE

VLAHOVIC T. (MNE)	13
SLACEK N. (CRO)	14
MICHAIL M. (CYP)	15
KURDGELIA E. (GEO)	16
KNAFELC N. (SLO)	17
ILIC S. (SRB)	18
APETREI M. (ITA)	19

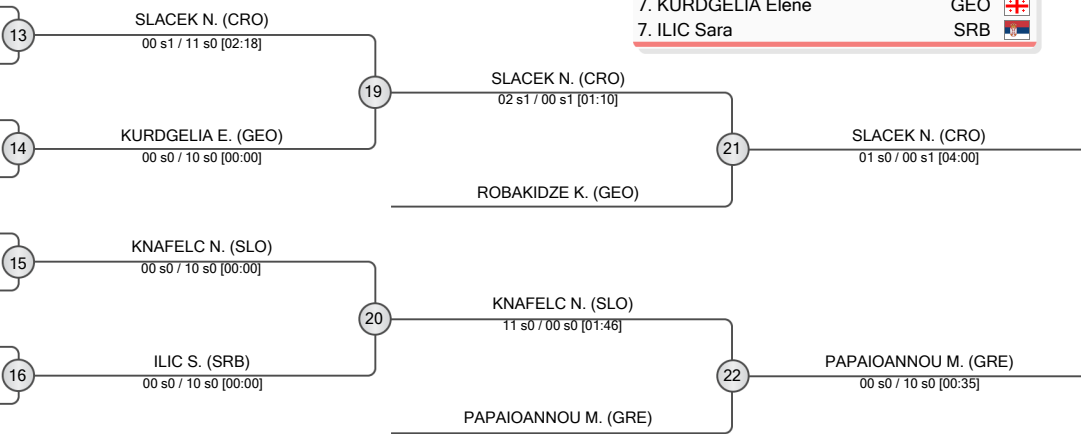

FINAL RESULTS

1. DZIDIC Korina	BIH	
2. KLINGER Johanna Elisabeth	BIH	
3. SLACEK Nika	CRO	
3. PAPAIOANNOU Maria Eleni	GRE	
5. ROBAKIDZE Ket	GEO	
5. KNAFELC Noeli	SLO	
7. KURDGELIA Elene	GEO	
7. ILIC Sara	SRB	



POOL A

	KVARATSKHELIA Nona	GEO
	OGKANESIAN Natalia	GRE

1 KVARATSKHELIA N. (GEO)

02 s0 / 00 s0 [01:10]

POOL B

	REPIAKH Aleksandra	IJF
	CHERKELIEVA Maria	BUL

2 REPIAKH A. (IJF)

11 s0 / 00 s0 [01:34]

POOL C

	SCHIAVON Carlotta	ITA
	KAPIANIDZE Nia	GEO

3 SCHIAVON C. (ITA)

01 s0 / 00 s0 [04:00]

POOL D

	NIKETIC Leona	CRO
	KAJTAZOVIC Danijela	BIH

4 KAJTAZOVIC D. (BIH)

01 s1 / 10 s0 [03:19]

REPECHAGE

OGKANESIAN N. (GRE)	7	CHERKELIEVA M. (BUL)
CHERKELIEVA M. (BUL)		00 s0 / 02 s1 [02:58]

CHERKELIEVA M. (BUL)

11 s1 / 01 s0 [05:07]

KAPIANIDZE N. (GEO)	8	NIKETIC L. (CRO)
NIKETIC L. (CRO)		00 s0 / 10 s0 [01:21]

8 NIKETIC L. (CRO)

11 s1 / 01 s0 [05:07]

10 KVARATSKHELIA N. (GEO)

11 s1 / 01 s0 [05:07]

5 REPIAKH A. (IJF)

00 s0 / 01 s1 [04:00]

11 REPIAKH A. (IJF)

10 s0 / 00 s0 [01:07]

FINAL RESULTS

1. REPIAKH Aleksandra	IJF	
2. SCHIAVON Carlotta	ITA	
3. CHERKELIEVA Maria	BUL	
3. KVARATSKHELIA Nona	GEO	
5. KAJTAZOVIC Danijela	BIH	
5. NIKETIC Leona	CRO	