

439 competitors from 29 nations

295 Men

144 Women

67.20%

32.80%

-50 kg	-55 kg	-60 kg	-66 kg	-73 kg	-81 kg	-90 kg	+90 kg	Men
23	41	61	52	47	38	21	12	295

-40 kg	-44 kg	-48 kg	-52 kg	-57 kg	-63 kg	-70 kg	+70 kg	Women
0	15	27	25	30	25	14	8	144









Continent	AJU	JUA	EJU	OJU	PJC	Total
Nations		2	26		1	29
Competitors		16	422		1	439

Schedule		
Date	23 Nov	24 Nov
Start	09:00	09:00
End	17:10	15:10
Finals start	17:30	16:00
Finals end	19:18	20:30

-50 kg		
1	MARTINOV Tsvetelin	BUL 
2	SEILKHAN Daniyal	KAZ 
3	GULIYEV Anar	AZE 
3	PENEZ Enzo	FRA 
5	GILBERT Coen	GBR 
5	SPINU Arsenijs	LAT 
7	HOFFMANN Andrea	FRA 
7	ALEKSIEJUNAS Natas	LTU 









-55 kg		
1	BUTUCI Kristian	CRO 
2	JAKUBAUSKAS Adris	LTU 
3	MILOSEVIC Aleksa	SRB 
3	GASIMZADE Rustam	AZE 
5	GALENKOV Ivo	BUL 
5	HUSIYEV Mahammadali	AZE 
7	HUSEYNLI Emil	AZE 
7	AMANGELDY Beknur	KAZ 



-60 kg		
1	ALASGAROV Zeyd	AZE 
2	KONYSBAY Altynbek	KAZ 
3	DOSBERGEN Nurdos	KAZ 
3	IGILIK Margulan	KAZ 
5	GARAYEV Ilkin	AZE 
5	SASSI Thomas	ITA 
7	SHTAIN Tomer	ISR 
7	TURYSBEK Yerzhanibek	KAZ 

-66 kg		
1	KARALEVICIUS Zygimantas	LTU 
2	SAHIBZADE Fakhri	AZE 
3	BORCHASHVILI Chinig	GEO 
3	BABACHEV Stiliyan	BUL 
5	GULIYEV Ozgan	AZE 
5	HERTA David	MDA 
7	FRIEDRICH Noam	ISR 
7	BREGVADZE Nika	GEO 







-73 kg		
1	GIVISHVILI Giorgi	GEO 
2	KURDGELASHVILI Nikoloz	GEO 
3	SHARIFOV Said	AZE 
3	GAMEZARDASHVILI Vasil	GEO 
5	SPETSIOS Kyriakos	CYP 
5	MERCEA David Emanuel	ROU 
7	MACHURIDZE Vladimer	GEO 
7	AGHAKISHIYEV Mahammad	AZE 









-81 kg		
1	MUKHUM Rassul	KAZ 
2	BABAICENKO Tajus	LTU 
3	MEHDIYEV Amin	AZE 
3	BAKHTADZE Tsotne	GEO 
5	RAHMATOV Abdullah	AZE 
5	BUMAZKINS Jelisejs	LAT 
7	GELASHVILI Levan	GEO 
7	NAPSO Aslan	ISR 







-90 kg		
1	SHOSHIN Nikita	IJF 
2	MILICEVIC Ivan	BIH 
3	DJINKIC Ivano	BIH 
3	SUNDBY Marius	NOR 
5	SIMIC Nemanja	SRB 
5	KONCILIIJA Dan	CRO 
7	PRUIDZE Saba	GEO 
7	HUSEYNOV Said	AZE 

+90 kg		
1	AKHUNDOV Subhan	AZE 
2	IVANKOVIC Luka	CRO 
3	ZHAUDINOV Adilzhan	KAZ 
3	FARZALIYEV Tunar	AZE 
5	BAZARKATOV Yeraly	KAZ 
5	CORKOVIC Filip	SRB 
7	GULARASHVILI Viktor	GRE 
7	NOVAKOVIC Petar	SRB 







-40 kg		









-44 kg		
1	TOKMAK Havva Sena	TUR 
2	MEKI Fatma Zehra	TUR 
3	AUREL Mathilde	FRA 
3	GABAY Yuval	ISR 
5	CONI Sara	GBR 
5	SERBAN Denisa	ROU 
7	FERRO Aurora	ITA 
7	LONGO Sofia	ITA 

-48 kg		
1	SHYNGGYSKHAN Gulkhan	KAZ 
2	RUSLANOVA Assel	KAZ 
3	MILHAVET Agathe	FRA 
3	IDDIR Celine	FRA 
5	PODYMSKA Nina	POL 
5	CULJAK Petra	BIH 
7	ERCIN Rahime	TUR 
7	RASIC Mara	SRB 























-52 kg		
1	SAVIC Bojana	SRB 
2	TATRISHVILI Sopio	GEO 
3	LOPEZ Alice	FRA 
3	YAHAV Yali	ISR 
5	HAMDAOUI Dina-Syrine	FRA 
5	FIROTTO Chiara	ITA 
7	DI LEONARDO Noemi	ITA 
7	IATAGAN Maria	ROU 

-57 kg		
1	CAPEZZUTO Martina	ITA 
2	GAMIASHVILI Tamar	GEO 
3	AZINOU Marina	CYP 
3	DOS REIS Constance	FRA 
5	SKOMERSIC Maria	CRO 
5	HADAR Noa	ISR 
7	GLIGA Ana	ROU 
7	PKHAKADZE Barbara	GEO 

-63 kg		
1	FROSONI Giorgia	ITA 
2	THOMSON Maia	CAN 
3	DALMASSO Madeleine	FRA 
3	AUBERT GOMEZ Maya	GBR 
5	MATSIRIDI Sophia	GRE 
5	IMERI Sara	CRO 
7	MATSIRIDI Drosia	GRE 
7	GRAMBO Anna	NOR 

-70 kg		
1	DZIDIC Korina	BIH 
2	KLINGER Johanna Elisabeth	BIH 
3	SLACEK Nika	CRO 
3	PAPAIOANNOU Maria Eleni	GRE 
5	ROBAKIDZE Ketii	GEO 
5	KNAFELC Noeli	SLO 
7	KURDGELIA Elene	GEO 
7	ILIC Sara	SRB 

+70 kg		
1	REPIAKH Aleksandra	IJF 
2	SCHIAVON Carlotta	ITA 
3	CHERKELIEVA Maria	BUL 
3	KVARATSKHELIA Nona	GEO 
5	KAJTAZOVIC Danijela	BIH 
5	NIKETIC Leona	CRO 

#	Nation	1. Place	2. Place	3. Place	5. Place	7. Place
1.	 KAZ Kazakhstan	2	3	3	1	2
2.	 AZE Azerbaijan	2	1	5	4	3
3.	 ITA Italy	2	1		2	3
4.	 GEO Georgia	1	3	4	1	6
5.	 BIH Bosnia and Herzegovina	1	2	1	2	
6.	 LTU Lithuania	1	2			1
7.	 CRO Croatia	1	1	1	4	
8.	 TUR Türkiye	1	1			1
9.	 BUL Bulgaria	1		2	1	
10.	 SRB Serbia	1		1	2	3
11.	 CAN Canada		1			
12.	 FRA France			7	1	1
13.	 ISR Israel			2	1	3
14.	 GBR Great Britain			1	2	
15.	 GRE Greece			1	1	2
16.	 CYP Cyprus			1	1	
17.	 NOR Norway			1		1
18.	 ROU Romania				2	2
19.	 LAT Latvia				2	
20.	 POL Poland				1	
20.	 MDA Republic of Moldova				1	
20.	 SLO Slovenia				1	

Official person:



Statistics

Thessaloniki Cadet European Cup 2024, 23-24 Nov 2024

Statistics

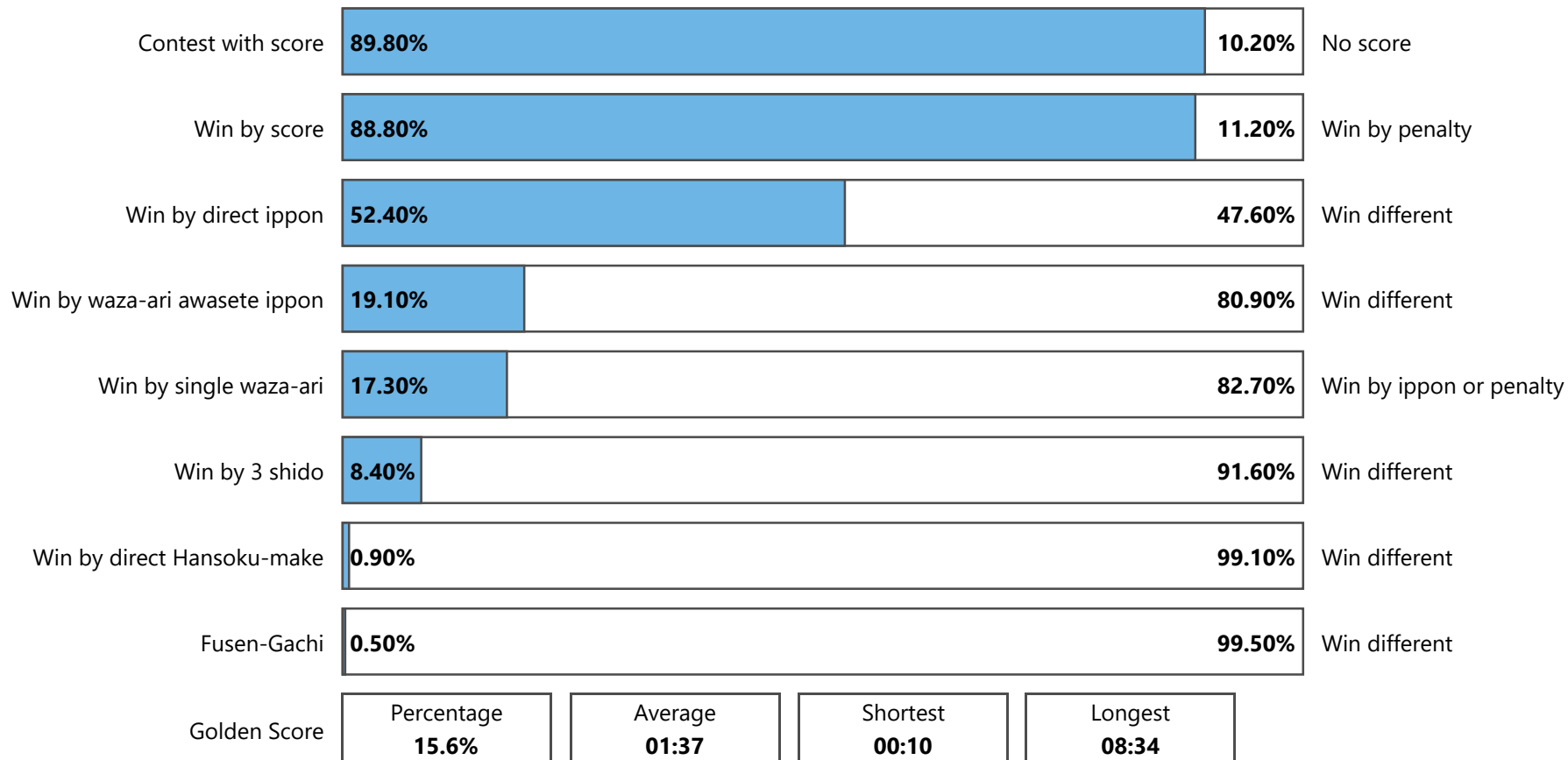































Statistics

Thessaloniki Cadet European Cup 2024, 23-24 Nov 2024

Statistics

	-50	-55	-60	-66	-73	-81	-90	+90	M	-40	-44	-48	-52	-57	-63	-70	+70	W	Total
Competitors	23	41	61	52	47	38	21	12	295		15	27	25	30	25	14	8	144	439
Contests	32	53	75	65	60	49	28	16	378		21	35	32	40	34	20	11	193	571
Contests with score	31	43	68	63	58	45	26	15	349		20	32	25	32	28	16	11	164	513
Contests with score %	96.9%	81.1%	90.7%	96.9%	96.7%	91.8%	92.9%	93.8%	92.3%	0%	95.2%	91.4%	78.1%	80%	82.4%	80%	100%	85.0%	89.8%
Wins by Score	31	42	68	62	57	44	26	15	345		20	31	25	31	28	16	11	162	507
Wins by Score %	96.9%	79.2%	90.7%	95.4%	95%	89.8%	92.9%	93.8%	91.3%	0%	95.2%	88.6%	78.1%	77.5%	82.4%	80%	100%	83.9%	88.8%
Wins by direct Ippon	18	19	38	36	35	28	17	11	202		9	21	12	18	20	12	5	97	299
Wins by direct Ippon %	56.3%	35.8%	50.7%	55.4%	58.3%	57.1%	60.7%	68.8%	53.4%	0%	42.9%	60%	37.5%	45%	58.8%	60%	45.5%	50.3%	52.4%
Wins by Waza-ari Awasete Ippon	6	11	10	20	16	8	7	3	81		4	6	4	5	4	1	4	28	109
Wins by Waza-ari Awasete Ippon %	18.8%	20.8%	13.3%	30.8%	26.7%	16.3%	25%	18.8%	21.4%	0%	19%	17.1%	12.5%	12.5%	11.8%	5%	36.4%	14.5%	19.1%
Wins by single Waza-ari	7	12	20	6	6	8	2	1	62		7	4	9	8	4	3	2	37	99
Wins by single Waza-ari %	21.9%	22.6%	26.7%	9.2%	10%	16.3%	7.1%	6.3%	16.4%	0%	33.3%	11.4%	28.1%	20%	11.8%	15%	18.2%	19.2%	17.3%
Wins by 3 Shido for opponent	1	9	4	2	3	4	1	1	25		1	4	6	5	4	3		23	48
Wins by 3 Shido for opponent %	3.1%	17%	5.3%	3.1%	5%	8.2%	3.6%	6.3%	6.6%	0%	4.8%	11.4%	18.8%	12.5%	11.8%	15%	0%	11.9%	8.4%
Direct Hansoku-make		1	2						3					1	1			2	5
Wins by direct Hansoku-make %	0%	1.9%	2.7%	0%	0%	0%	0%	0%	0.8%	0%	0%	0%	0%	2.5%	2.9%	0%	0%	1.0%	0.9%
Fusen-gachi														2		1		3	3
Fusen-gachi %	0%	0%	0%	0%	0%	0%	0%	0%	0%	0%	0%	0%	0%	5%	0%	5%	0%	1.6%	0.5%
All positive Scores (Waza-ari + direct Ippon)	39	58	90	99	90	58	39	20	493		29	44	32	48	35	22	19	229	722
Average Scores per contests	1.2	1.1	1.2	1.5	1.5	1.2	1.4	1.3	1.3		1.4	1.3	1	1.2	1	1.1	1.7	1.09	1.19
All penalties (Shido + HSK)	34	94	90	62	56	37	21	21	415		31	52	48	46	35	32	7	251	666
Average penalty per contest	1.1	1.8	1.2	1	0.9	0.8	0.8	1.3	1.11		1.5	1.5	1.5	1.2	1	1.6	0.6	1.11	1.11
Golden Score	4	12	14	6	9	8	3	2	58		5	3	7	6	7	2	1	31	89
Golden Score %	12.5%	22.6%	18.7%	9.2%	15%	16.3%	10.7%	12.5%	15.3%	0%	23.8%	8.6%	21.9%	15%	20.6%	10%	9.1%	16.1%	15.6%
Osae-komi																			
Osae-komi %	0%	0%	0%	0%	0%	0%	0%	0%	0%	0%	0%	0%	0%	0%	0%	0%	0%	0%	0%
Wins by Penalty	1	10	6	2	3	4	1	1	28		1	4	6	6	5	3		25	53

			-50	-55	-60	-66	-73	-81	-90	+90	M	-40	-44	-48	-52	-57	-63	-70	+70	W	Total	D	
1.		ALB	Albania	0	0	0	0	0	0	0	0	0	0	0	0	1	0	0	0	1	1	1	
2.		AZE	Azerbaijan	1	4	3	3	2	3	1	3	20	0	0	0	0	0	0	0	0	0	20	4
3.		BIH	Bosnia and Herzegovina	0	0	0	0	4	0	2	0	6	0	0	1	1	1	2	2	1	8	14	3
4.		BUL	Bulgaria	3	6	5	6	6	2	1	0	29	0	2	3	1	0	2	0	1	9	38	6
5.		CAN	Canada	0	0	0	0	0	0	0	0	0	0	0	0	0	1	0	0	1	1	0	
6.		CRO	Croatia	0	2	1	2	1	0	3	1	10	0	0	1	1	2	2	2	1	9	19	6
7.		CYP	Cyprus	2	1	5	2	5	3	0	0	18	0	1	0	0	1	0	1	0	3	21	3
8.		FRA	France	2	4	3	3	1	1	0	0	14	0	1	3	2	3	3	0	0	12	26	16
9.		GBR	Great Britain	1	0	1	0	0	0	0	0	2	0	1	1	0	1	1	0	0	4	6	3
10.		GEO	Georgia	2	2	5	4	6	2	1	0	22	0	2	1	1	2	1	3	2	12	34	4
11.		GRE	Greece	3	5	16	10	7	8	4	2	55	0	0	5	3	4	7	2	1	22	77	16
12.		HUN	Hungary	0	0	0	1	0	0	0	0	1	0	0	0	0	0	0	0	0	0	1	1
13.		IJF	International Judo Federation	0	0	0	0	0	0	1	0	1	0	0	0	0	0	0	0	1	1	2	1
14.		ISR	Israel	2	6	8	11	4	6	1	0	38	0	1	1	3	2	0	0	0	7	45	9
15.		ITA	Italy	1	2	2	0	1	1	0	0	7	0	2	0	3	2	1	1	1	10	17	10
16.		KAZ	Kazakhstan	1	2	4	1	0	1	0	2	11	0	0	3	0	1	0	0	0	4	15	3
17.		KGZ	Kyrgyzstan	0	0	1	0	0	0	0	0	1	0	0	0	0	0	0	0	0	0	1	1
18.		LAT	Latvia	1	0	0	0	1	2	0	0	4	0	0	0	0	0	0	0	0	0	4	1
19.		LTU	Lithuania	1	2	0	1	0	1	0	0	5	0	0	0	0	1	0	0	0	1	6	2
20.		LUX	Luxembourg	1	0	0	1	1	0	1	0	4	0	0	0	1	0	0	0	0	1	5	1
21.		MDA	Republic of Moldova	0	0	0	1	0	1	0	0	2	0	0	1	1	0	1	0	0	3	5	1
22.		MKD	North Macedonia	0	0	0	0	0	0	0	0	0	0	0	2	0	0	1	0	0	3	3	1
23.		MNE	Montenegro	0	1	0	0	1	1	2	1	6	0	0	0	0	0	0	1	0	1	7	1
24.		NOR	Norway	0	0	2	1	0	2	1	0	6	0	0	1	0	1	1	0	0	3	9	4
25.		POL	Poland	0	0	0	1	2	0	1	0	4	0	0	1	1	0	0	0	0	2	6	3
26.		ROU	Romania	0	1	2	2	2	2	1	1	11	0	2	1	3	3	1	0	0	10	21	7
27.		SLO	Slovenia	0	0	0	0	0	0	0	0	0	0	0	0	1	0	1	0	2	2	2	
28.		SRB	Serbia	1	2	2	2	3	1	1	2	14	0	0	1	3	3	1	1	0	9	23	7
29.		TUR	Türkiye	1	1	1	0	0	1	0	0	4	0	3	1	1	1	0	0	0	6	10	1
				23	41	61	52	47	38	21	12	295	0	15	27	25	30	25	14	8	144	439	118



Thessaloniki Cadet European Cup 2024

Greece, Thessaloniki, 23-24 Nov 2024

-50 kg

Men (23)

POOL A

	MARTINOV Tsvetelin	BUL
	ANASTASOV Pavlos	GRE
	TROULLIDES Nasos	CYP
	ATANASOV Atanas	BUL
	GILBERT Coen	GBR
	MDINARADZE Tornike	GEO

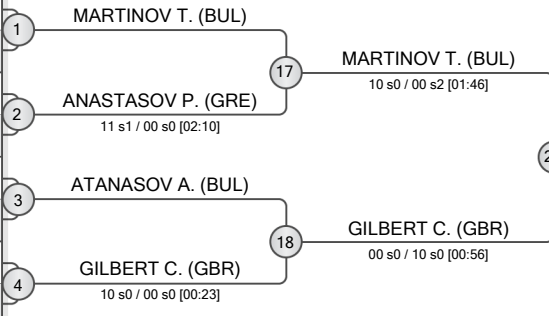

POOL B

	CHIARELLA Luca	ITA
	NIKOLAKOPOULOS Antonios	GRE
	HOFFMANN Andrea	FRA
	SPINU Arsenijs	LAT
	DJOKIC Ignjat	SRB
	MARCHIORI Ugo	LUX

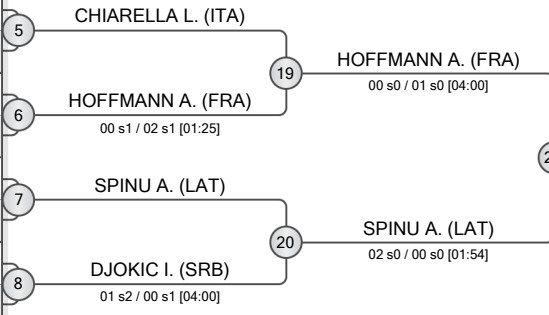

POOL C

	ALEKSIEJUNAS Natas	LTU
	OZDEMIR Muhammed Enes	TUR
	GULIYEV Anar	AZE
	SHEMESH Shachar	ISR
	ANASTASOPOULOS Dimitrios-Dionysios	GRE

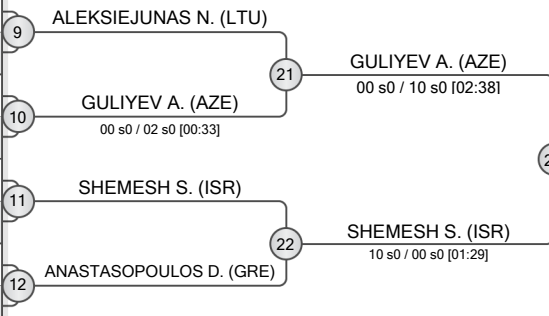

POOL D

	PENEZ Enzo	FRA
	DUMBADZE Giorgi	GEO
	FELLOUKA Loizos	CYP
	GART Lidor	ISR
	SARACHEV Denislav	BUL
	SEILKHAN Daniyal	KAZ

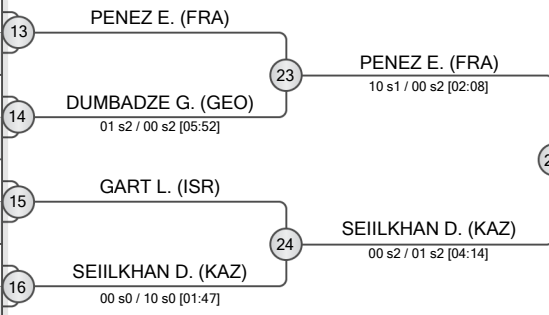

REPECHAGE

29	ANASTASOV P. (GRE)	33	GILBERT C. (GBR)
30	DJOKIC I. (SRB)	34	HOFFMANN A. (FRA)
31	ALEKSIEJUNAS N. (LTU)	35	ALEKSIEJUNAS N. (LTU)
32	GART L. (ISR)	36	PENEZ E. (FRA)

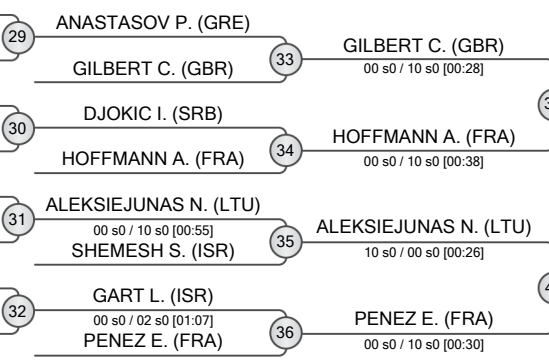

FINAL RESULTS	
1.	MARTINOV Tsvetelin BUL
2.	SEILKHAN Daniyal KAZ
3.	GULIYEV Anar AZE
5.	GILBERT Coen GBR
7.	ALEKSIEJUNAS Natas LTU





Thessaloniki Cadet European Cup 2024

Greece, Thessaloniki, 23-24 Nov 2024

-55 kg

Men (41)

POOL A

	JAKUBAUSKAS Adris	LTU	1
	STEFANOV Samuil	BUL	2
	CUQ Axel	FRA	3
	PARIPOVIC Andrija	CRO	3
	MIZRAHI Ori	ISR	4
	HUSEYNLI Emil	AZE	5
	MALCA Yair	ISR	6
	MAVRIDIS Leonidas	GRE	7
	UCAR Mehmet Ali	TUR	7
	YERGALIYEV Aslan	KAZ	8

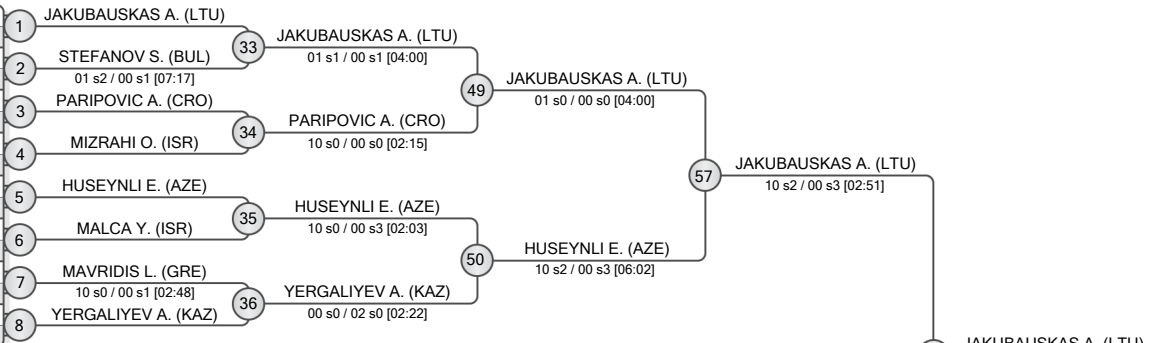

POOL B

	MAKULAVICIUS Rokas	LTU	9
	HAGILADY DAUM Alon	ISR	10
	HUSIYEV Mahammadali	AZE	11
	MUGGIANU Matteo	ITA	11
	MITOVSKI Denis	BUL	12
	MILOSEVIC Aleksa	SRB	13
	PILAUARI Saba	GEO	14
	ZAIMIDIS Petros	GRE	14
	LEFORESTIER Corentin	FRA	15
	STOYANOV Mihail	BUL	16

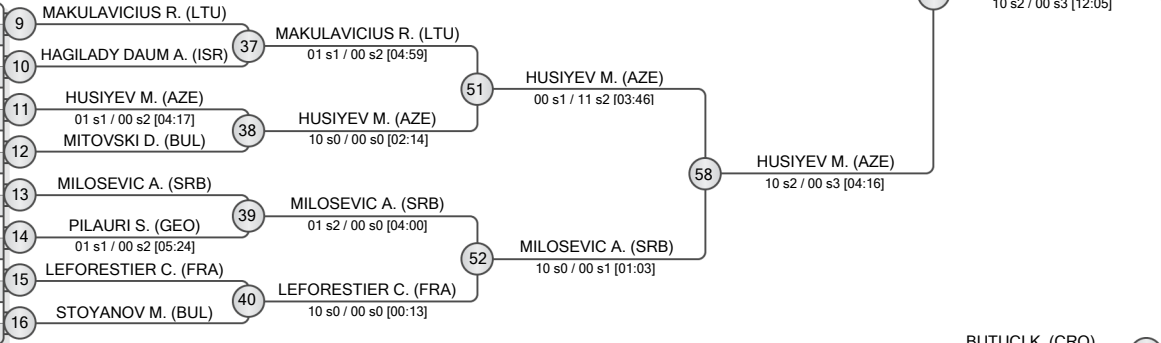

POOL C

	LUCAS Titouan	FRA	17
	MILUSHEV Deyan	BUL	18
	GASIMZADE Rustam	AZE	18
	PETROVIC Nikola	SRB	19
	STAAL Rotem	ISR	20
	GALENKOV Ivo	BUL	21
	KALOGIROS Georgios	GRE	22
	ZYCHLINSKI Ido	ISR	22
	SINDJIC Balsa	MNE	23
	SOFIOGLOU Nikolaos	GRE	23
	SANDRINI Angelo Karol	ITA	24

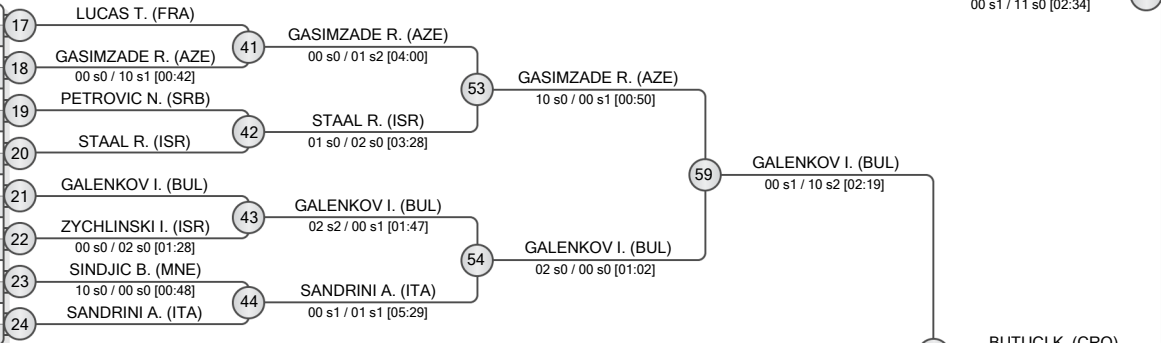

POOL D

	BUTUCI Kristian	CRO	25
	BOUNTAGKIDIS Alexandros	CYP	26
	AMANGELDY Beknur	KAZ	27
	TOREN Noam	ISR	27
	SPANOS Theodoros	GRE	28
	SORICI Alin Marian	ROU	29
	CALARNOU Evan	FRA	30
	RUSTAMLI Mahammad	AZE	30
	ZIRAKASHVILI Merabi	GEO	31
	GEORGIEV Valentin	BUL	32

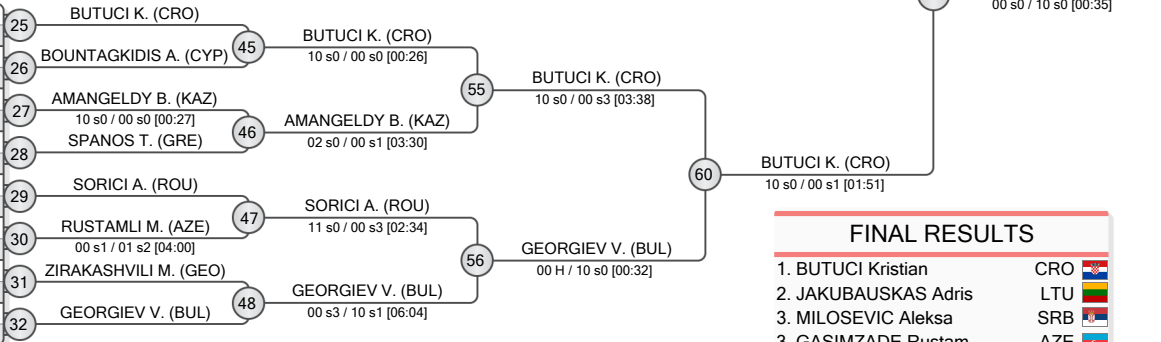

FINAL RESULTS		
1.	BUTUCI Kristian	CRO
2.	JAKUBAUSKAS Adris	LTU
3.	MILOSEVIC Aleksa	SRB
3.	GASIMZADE Rustam	AZE
5.	GALENKOV Ivo	BUL
5.	HUSIYEV Mahammadali	AZE
7.	HUSEYNLI Emil	AZE
7.	AMANGELDY Beknur	KAZ

REPECHAGE

STEFANOV S. (BUL)	61	STEFANOV S. (BUL)	61
MUGGIANU M. (ITA)	62	MUGGIANU M. (ITA)	62
MITOVSKI D. (BUL)	62	MITOVSKI D. (BUL)	62
ZYCHLINSKI I. (ISR)	63	ZYCHLINSKI I. (ISR)	63
BOUNTAGKIDIS A. (CYP)	64	BOUNTAGKIDIS A. (CYP)	64

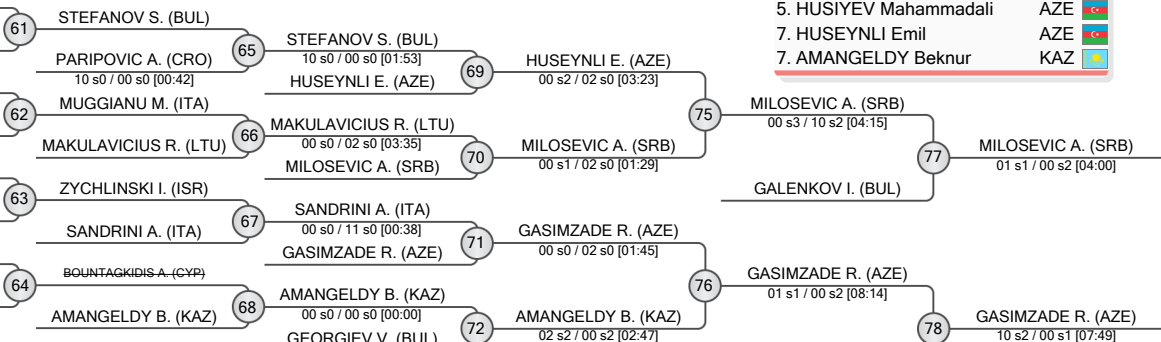



Thessaloniki Cadet European Cup 2024

Greece, Thessaloniki, 23-24 Nov 2024

-60 kg

Men (61)

POOL A

KONYSBAY Altynbek	KAZ	1	KONYSBAY A. (KAZ)
FOUSTERIS Panagiotis	GRE	2	THIRY L. (FRA)
THIRY Louis	FRA	2	00 s0 / 10 s0 [00:48]
ADYLBKOV Alymbek	KGZ	3	SHTAIN T. (ISR)
SHTAIN Tomer	ISR	3	00 s0 / 10 s1 [02:42]
AVRAMOVIC Vanja	SRB	4	AVRAMOVIC V. (SRB)
KARIPIDIS Marios	GRE	4	10 s0 / 00 H [06:05]
IONITA David	ROU	5	IONITA D. (ROU)
MAGEIRIAS Nikitas	GRE	5	10 s0 / 00 s0 [00:26]
AFXENTIOU Afxentis	CYP	6	KARIMOV A. (AZE)
KARIMOV Abdullah	AZE	6	00 s1 / 01 s1 [04:00]
KANJARASHVILI Luka	GEO	7	KANJARASHVILI L. (GEO)
POLYCHRONIDIS Alexandros	GRE	7	01 s0 / 00 s0 [04:00]
DOBREV Hristiyan	BUL	8	KORIAT I. (ISR)
KORIAT Ido	ISR	8	00 H / 10 s0 [04:54]

POOL B

ERLANDSEN-SELE Brink	NOR	9	ROTSOS P. (GRE)
ROTSOS Petros	GRE	9	01 s2 / 02 s1 [03:03]
TEKIN Suleyman	TUR	10	SASSI T. (ITA)
SASSI Thomas	ITA	10	00 s0 / 02 s0 [00:25]
HADJIYIANNIS Nestoras	CYP	11	HADJIYIANNIS N. (CYP)
SOPILIDIS Georgios	GRE	11	01 s1 / 00 s0 [08:35]
MCHEDLISHVILI Nikoloz	GEO	12	MCHEDLISHVILI N. (GEO)
YAACOBI Liav	ISR	12	10 s0 / 00 s0 [01:01]
TOMASIC Mateo	CRO	13	TOMASIC M. (CRO)
GEORGIAKIS Konstantinos	GRE	13	10 s0 / 00 s3 [03:25]
NITSAN Boaz	ISR	14	NITSAN B. (ISR)
DIMITROV Stylianos	CYP	14	10 s0 / 00 s0 [01:12]
YOMBI ITOUA Jason Yanis	FRA	15	YOMBI ITOUA J. (FRA)
MIHAYLOV Boris	BUL	15	11 s0 / 00 s0 [00:36]
DOSBERGEN Nurdos	KAZ	16	DOSBERGEN N. (KAZ)
GIANNAKIS Georgios	GRE	16	11 s0 / 00 s0 [01:28]

POOL C

BREKKE-JENSSEN Torstein	NOR	17	BREKKE-JENSSEN T. (NOR)
CHOLAKOV Hristo	BUL	18	BOUKOUVALAS M. (GRE)
BOUKOUVALAS Maximos-Orestis	GRE	18	00 s0 / 10 s0 [02:34]
HOCHMAN Itay	ISR	19	HOCHMAN I. (ISR)
NANCEY Noe	FRA	19	01 s2 / 00 s1 [05:23]
MOUSIKOS Nikolas	CYP	20	POSNAKIDIS T. (GRE)
POSNAKIDIS Theodoros	GRE	20	00 s0 / 02 s1 [02:27]
IGILIK Margulan	KAZ	21	IGILIK M. (KAZ)
DIMITRAKAS Panagiotis	GRE	21	10 s0 / 00 s0 [02:07]
BACHOSHVILI Shota	GEO	22	GARAYEV I. (AZE)
GARAYEV Ilkin	AZE	22	01 s0 / 02 s2 [06:46]
BENISEK Filip	SRB	23	SHULMAN S. (ISR)
SHULMAN Shiloh	ISR	23	00 s2 / 10 s0 [06:00]
DESPOTIS Nikolaos	GRE	24	ATANASOV Y. (BUL)
ATANASOV Yuliy	BUL	24	00 s0 / 10 s0 [00:11]

POOL D

STAVROU Christos	CYP	25	STAVROU C. (CYP)
BOSEDLAKIDIS Christos	GRE	26	RIZEA T. (ROU)
RIZEA Tudor	ROU	26	00 s0 / 02 s0 [01:55]
CHUHNNENKO Roma	ISR	27	GHEORGHU D. (GBR)
GHEORGHU David	GBR	27	00 s3 / 10 s0 [03:52]
DARISPANASHVILI Luka	GEO	28	DARISPANASHVILI L. (GEO)
MALERDOS Dimitrios	GRE	28	10 s0 / 00 s0 [00:10]
TURYSBEK Yerzhanibek	KAZ	29	ALASGAROV Z. (AZE)
ALASGAROV Zeyd	AZE	29	00 s1 / 01 s0 [04:00]
BOSEDLAKIDIS Evangelos	GRE	30	ODIKADZE O. (GEO)
ODIKADZE Otari	GEO	30	00 s0 / 10 s0 [00:41]
TZUR Idan	ISR	31	TZUR I. (ISR)
DIOS Emmanouil	GRE	31	11 s0 / 00 s0 [00:44]
MOSCIONI Lorenzo	ITA	32	DIMITROV S. (BUL)
DIMITROV Samuil	BUL	32	00 s0 / 11 s0 [00:37]

REPECHAGE

THIRY L. (FRA)	61	THIRY L. (FRA)	65	SHTAIN T. (ISR)	69	SHTAIN T. (ISR)
TEKIN S. (TUR)	62	SHTAIN T. (ISR)	65	00 s3 / 10 s1 [03:06]	69	10 s2 / 00 s1 [03:26]
ROTSOS P. (GRE)	62	TEKIN S. (TUR)	66	KARIMOV A. (AZE)	70	10 s2 / 00 s1 [03:26]
BACHOSHVILI S. (GEO)	63	MCHEDLISHVILI N. (GEO)	66	TEKIN S. (TUR)	70	10 s0 / 00 s0 [00:41]
IGILIK M. (KAZ)	63	IGILIK M. (KAZ)	67	DOSBERGEN N. (KAZ)	71	01 s0 / 10 s0 [00:59]
TURYSBEK Y. (KAZ)	64	ATANASOV Y. (BUL)	67	IGILIK M. (KAZ)	71	10 s0 / 00 s3 [03:40]
ODIKADZE O. (GEO)	64	TURYSBEK Y. (KAZ)	68	BREKKE-JENSSEN T. (NOR)	72	10 s0 / 00 s3 [03:40]
		DIMITROV S. (BUL)	68	TURYSBEK Y. (KAZ)	72	10 s0 / 00 s0 [03:16]
				DARISPANASHVILI L. (GEO)	72	01 s2 / 00 s2 [04:00]

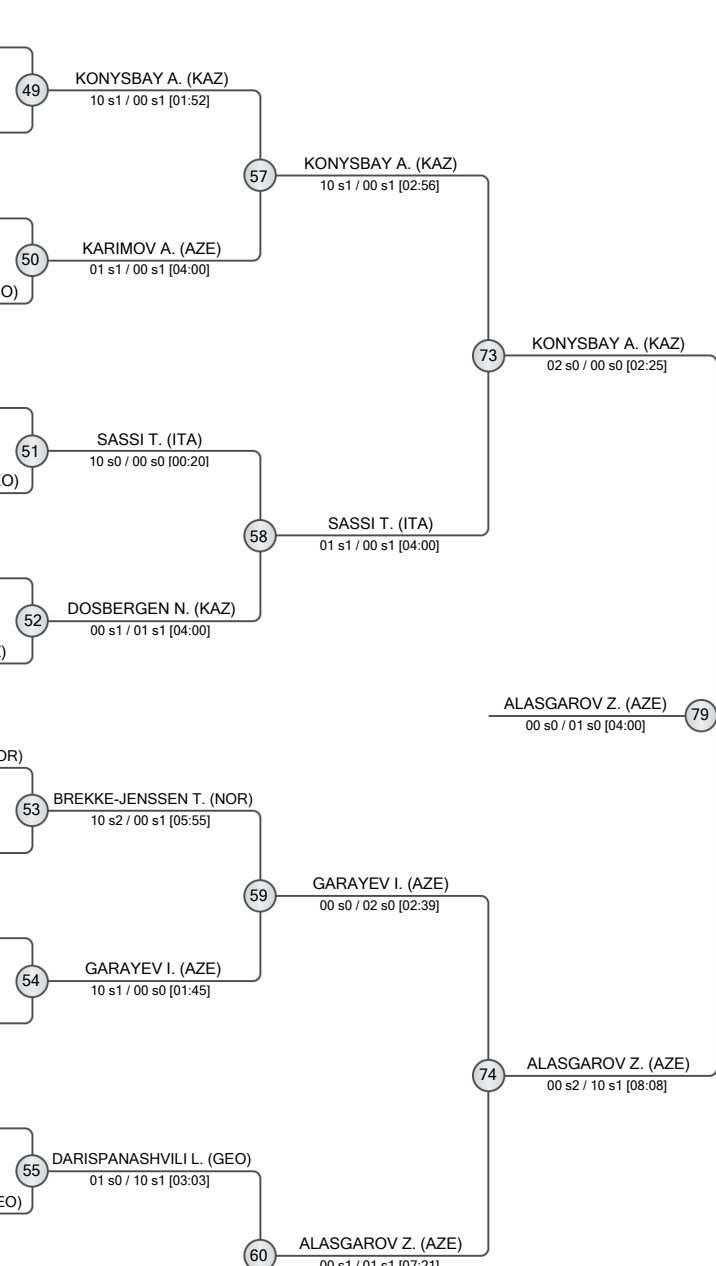

FINAL RESULTS		
1. ALASGAROV Zeyd	AZE	
2. KONYSBAY Altynbek	KAZ	
3. DOSBERGEN Nurdos	KAZ	
3. IGILIK Margulan	KAZ	
5. GARAYEV Ilkin	AZE	
7. SASSI Thomas	ITA	
7. SHTAIN Tomer	ISR	
7. TURYSBEK Yerzhanibek	KAZ	





Thessaloniki Cadet European Cup 2024

Greece, Thessaloniki, 23-24 Nov 2024

-66 kg

Men (52)

POOL A

	SAMADASHVILI Merabi	GEO
	BAIDAVLETOV Kirill	KAZ
	BELLOS Alexandros	GRE
	ANDROUTSOS Konstantinos	GRE
	LAFORGE Yann	FRA
	FRIEDRICH Noam	ISR
	SAHIBZADE Fakhri	AZE
	PRENTZAS Panagiotis	GRE
	SHACHAM Itamar	ISR
	MIRESCU Cristian	ROU
	ZLATKOV Ognjen	SRB
	BENZAKEN Emri	ISR
	MUSTAFOV Ferkan	BUL

1	SAMADASHVILI M. (GEO)	33	SAMADASHVILI M. (GEO)	
2	BAIDAVLETOV K. (KAZ)	01 s2 / 00 s2 [11:38]	10 s0 / 00 s0 [01:40]	
3	LAFORGE Y. (FRA)	00 s0 / 10 s0 [01:45]	34	FRIEDRICH N. (ISR)
4	FRIEDRICH N. (ISR)	00 s1 / 02 s0 [03:10]	49	FRIEDRICH N. (ISR)
5	SAHIBZADE F. (AZE)	35	SAHIBZADE F. (AZE)	
6	SHACHAM I. (ISR)	00 s0 / 11 s0 [01:08]	50	SAHIBZADE F. (AZE)
7	MIRESCU C. (ROU)	11 s1 / 01 s0 [03:03]	36	MIRESCU C. (ROU)
8	BENZAKEN E. (ISR)	01 s0 / 00 s1 [04:13]	10 s0 / 00 s0 [00:58]	

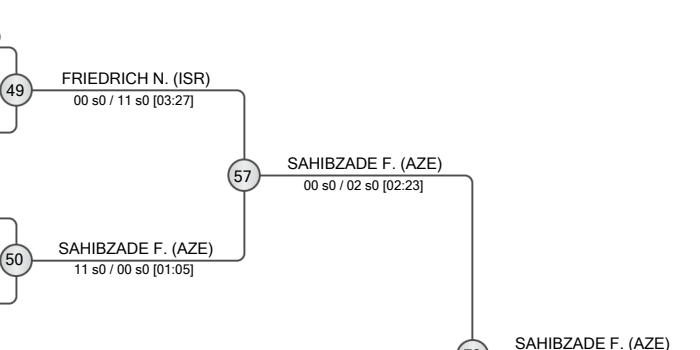

POOL B

	GUBBERUD Nino	NOR
	SEGAL Itamar	ISR
	SANDLERMAN Artur	POL
	MAMPENTZIDIS Georgios	GRE
	HERTA David	MDA
	LIVNI Ollie	ISR
	ATANASOV Kristiyan	BUL
	HADZI-VELJKOVIC Nikola	CRO
	BORCHASHVILI Chinig	GEO
	TZAMALIS Anastasios	GRE
	HADJISAVVAS Georgios	CYP
	BRUZHANITSKY Tal	ISR
	NIKOLOV Preslav	BUL

9	GUBBERUD N. (NOR)	37	SANDLERMAN A. (POL)	
10	SANDLERMAN A. (POL)	00 s0 / 02 s1 [01:38]	01 s0 / 02 s1 [03:51]	
11	HERTA D. (MDA)	00 s1 / 10 s0 [00:33]	38	HERTA D. (MDA)
12	ATANASOV K. (BUL)	00 s1 / 01 s0 [04:00]	10 s0 / 00 s0 [00:20]	
13	HADZI-VELJKOVIC N. (CRO)	39	BORCHASHVILI C. (GEO)	
14	BORCHASHVILI C. (GEO)	10 s0 / 00 s0 [00:47]	52	BORCHASHVILI C. (GEO)
15	BRUZHANITSKY T. (ISR)	00 s1 / 10 s0 [01:30]	40	BRUZHANITSKY T. (ISR)
16	NIKOLOV P. (BUL)	01 s2 / 00 s0 [04:00]		

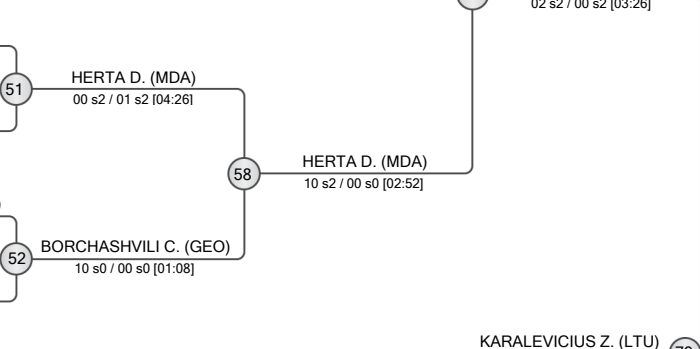

POOL C

	SEGA David	CRO
	PEPPOS Aimilios	CYP
	HAVIVI Omer	ISR
	BREGVADZE Nika	GEO
	GAVRILIS Michail Angelos	GRE
	DIMITROV Kristiyan	BUL
	SPANOS Georgios	GRE
	MOR Golan	ISR
	TRANDAFIR Adrian	ROU
	GAL Kristof	HUN
	GULIYEV Ozgan	AZE
	RALLIS Aggelos	GRE
	MEHAT Gabriel	FRA

17	SEGA D. (CRO)	41	SEGA D. (CRO)	
18	HAVIVI O. (ISR)	00 s1 / 10 s0 [01:25]	53	BREGVADZE N. (GEO)
19	BREGVADZE N. (GEO)	02 s2 / 00 s2 [03:42]	42	BREGVADZE N. (GEO)
20	DIMITROV K. (BUL)	11 s1 / 00 s0 [03:41]		
21	SPANOS G. (GRE)	43	SPANOS G. (GRE)	
22	TRANDAFIR A. (ROU)	00 s0 / 10 s1 [02:14]	54	GULIYEV O. (AZE)
23	GAL Kristof	00 s0 / 02 s0 [02:22]	44	GULIYEV O. (AZE)
24	MEHAT G. (FRA)	00 s0 / 10 s0 [02:12]		

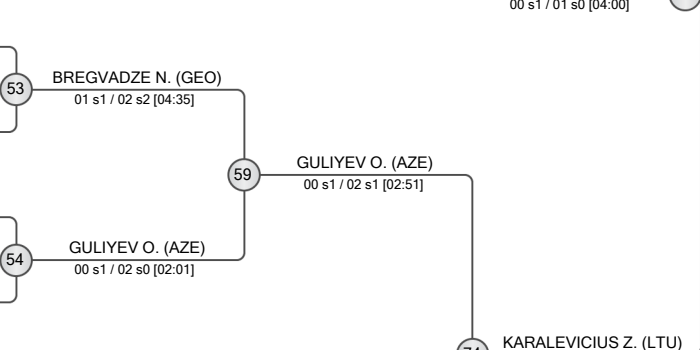

POOL D

	KARALEVICIUS Zygimantas	LTU
	BAR Yuval	ISR
	WARDE JONES Ben	LUX
	TODOROV Nikolay	BUL
	KALIFATIDIS Georgios	GRE
	SHVARTZ Yanir	ISR
	ALAKBAROV Aykhan	AZE
	BABACHEV Stiliyan	BUL
	FILIPOVIC Nenad	SRB
	TVALIASHVILI Daviti	GEO
	PAPADOPOULOS Nikolaos	GRE
	BANDEIRA Toan	FRA
	MIYARA Yuval	ISR

25	KARALEVICIUS Z. (LTU)	45	KARALEVICIUS Z. (LTU)	
26	BAR Y. (ISR)	02 s0 / 00 s0 [00:39]	55	KARALEVICIUS Z. (LTU)
27	TODOROV N. (BUL)	02 s0 / 00 s0 [01:02]	46	ALAKBAROV A. (AZE)
28	ALAKBAROV A. (AZE)	00 s2 / 11 s0 [02:01]	56	BABACHEV S. (BUL)
29	BABACHEV S. (BUL)	10 s0 / 00 s0 [00:49]	47	BABACHEV S. (BUL)
30	TVALIASHVILI D. (GEO)	00 s0 / 10 s0 [01:30]	58	MIYARA Y. (ISR)
31	BANDEIRA T. (FRA)	00 s0 / 11 s0 [00:26]	48	MIYARA Y. (ISR)
32	MIYARA Y. (ISR)	00 s0 / 10 s1 [03:05]		

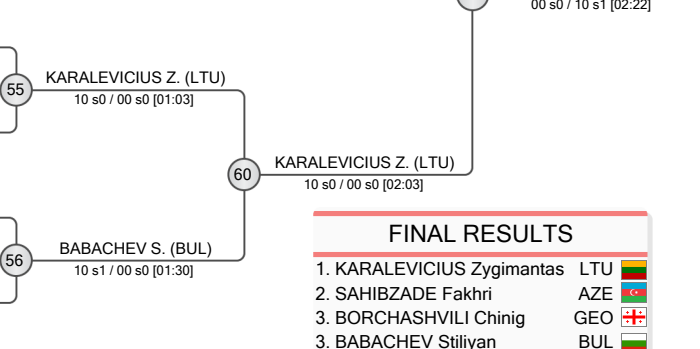

REPECHAGE

61	SHACHAM I. (ISR)	65	MIRESCU C. (ROU)
62	ATANASOV K. (BUL)	66	ATANASOV K. (BUL)
63	MEHAT G. (FRA)	67	SPANOS G. (GRE)
64	BAR Y. (ISR)	68	ALAKBAROV A. (AZE)

65	MIRESCU C. (ROU)	00 s1 / 11 s1 [02:21]	69	FRIEDRICH N. (ISR)
66	ATANASOV K. (BUL)	10 s0 / 00 s0 [01:06]	70	BORCHASHVILI C. (GEO)
67	SPANOS G. (GRE)	10 s2 / 00 s0 [02:16]	71	BREGVADZE N. (GEO)
68	ALAKBAROV A. (AZE)	00 s0 / 00 s0 [00:00]	72	BABACHEV S. (BUL)

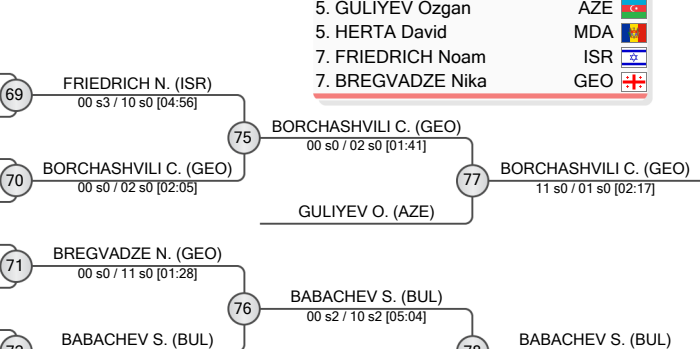

FINAL RESULTS		
1.	KARALEVICIUS Zygimantas	LTU
2.	SAHIBZADE Fakhri	AZE
3.	BORCHASHVILI Chinig	GEO
3.	BABACHEV Stiliyan	BUL
5.	GULIYEV Ozgan	AZE
5.	HERTA David	MDA
7.	FRIEDRICH Noam	ISR
7.	BREGVADZE Nika	GEO





Thessaloniki Cadet European Cup 2024

Greece, Thessaloniki, 23-24 Nov 2024

-73 kg

Men (47)

POOL A

	KULLO Tits	LAT
	VLAEV Bogdan	BUL
	CHERKAVSKY Maxim	ISR
	SHARIFOV Said	AZE
	PREDA Emanuel	ROU
	GIVISHVILI Giorgi	GEO
	PAVLOVIC Fredi	CRO
	JEREMIC Atanasije	SRB
	KADRIC Denis	BIH
	MIHALEV Nikolaz	BUL
	PETROSSIAN Garry	CYP
	ANDRONOPOULOS Nikolaos	GRE

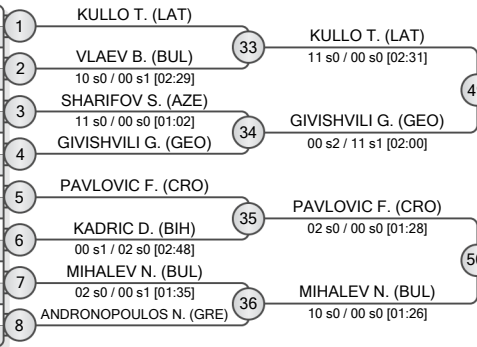

POOL B

	DINEV Aleksandar	BUL
	KAZOUKAS Georgios	GRE
	JUKA Stefan	BIH
	MACHURIDZE Vladimer	GEO
	HAYOUNE HAGBY Avi Shalom	ISR
	MORICONI Daniele	ITA
	PEPPOS Viktoras	CYP
	GAMEZARDASHVILI Vasil	GEO
	PAPADOPOULOS Georgios	GRE
	REBELO OSORIO Marcos	LUX
	HERMANSKI Szymon	POL

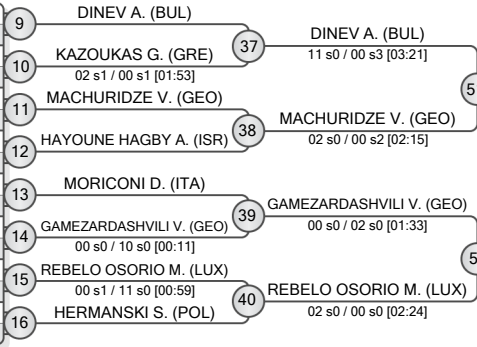

POOL C

	BORZECKI Jakub	POL
	CHARALAMPOUS Vladimiro	CYP
	DJURISIC Balsa	MNE
	DJORDJEVIC Jovan	SRB
	KATRANIDIS Ioannis	GRE
	SULJKANOVIC Ajdin	BIH
	MERCEA David Emanuel	ROU
	ANASTASIADIS Dionysios	GRE
	KURDGELASHVILI Nikoloz	GEO
	KAGLATZIS Panagiotis	CYP
	REISFELD Moran	ISR
	GELEV Bozhidar	BUL

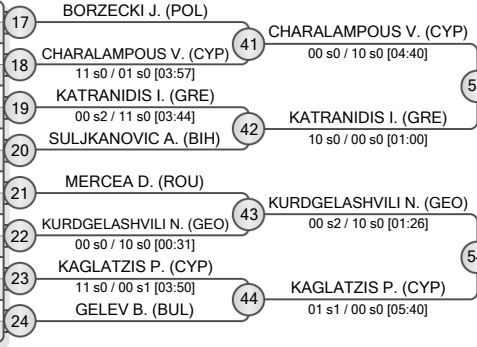

POOL D

	SPETSIOS Kyriakos	CYP
	AGHAKISHIYEV Mahammad	AZE
	DAMIANIDIS Vasileios	GRE
	KAMKAMIDZE Tengiz	GEO
	NATKHO Ryan	ISR
	DIMITROV Dimitar	BUL
	MAKSIMOVIC Vuk	BIH
	CHIKH Riad	FRA
	PERALOVIC Uros	SRB
	GKOLIAS Efthymios	GRE
	SAMSIANI Ieso	GEO
	GAVRAILOV Nikolay	BUL

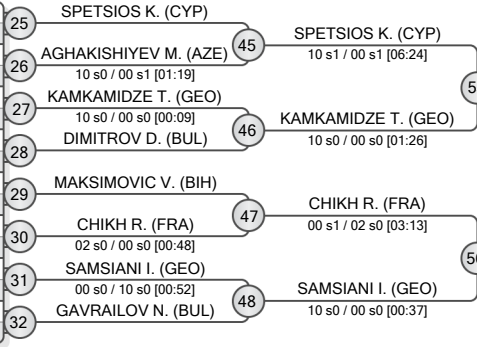

FINAL RESULTS	
1.	GIVISHVILI Giorgi GEO
2.	KURDGELASHVILI Nikoloz GEO
3.	SHARIFOV Said AZE
3.	GAMEZARDASHVILI Vasil GEO
5.	SPETSIOS Kyriakos CYP
7.	MERCEA David Emanuel ROU
7.	MACHURIDZE Vladimer GEO
7.	AGHAKISHIYEV Mahammad AZE

REPECHAGE

61	SHARIFOV S. (AZE)
62	MORICONI D. (ITA)
63	MERCEA D. (ROU)
64	AGHAKISHIYEV M. (AZE)
65	KULLO T. (LAT)
66	REBELO OSORIO M. (LUX)
67	MERCEA D. (ROU)
68	KAMKAMIDZE T. (GEO)
69	MIHALEV N. (BUL)
70	MACHURIDZE V. (GEO)
71	KATRANIDIS I. (GRE)
72	SAMSIANI I. (GEO)

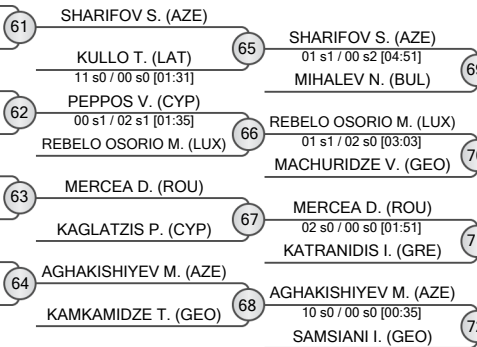



Thessaloniki Cadet European Cup 2024

Greece, Thessaloniki, 23-24 Nov 2024

-81 kg

Men (38)

POOL A

	MUKHUM Rassul	KAZ	1
	STATHOPOULOS Tryfonas	GRE	2
	ORFANOS Athanasios	CYP	3
	ZOARETZ Tomer	ISR	4
	SOLHAUG Fredrik Holm	NOR	5
	MOGILNI Kirill	ISR	6
	TCHENDJE KENMEUE Arthur	FRA	7
	BOUKOUVALAS Agathoklis-Aris	GRE	8
	RAHMATOV Abdullah	AZE	9
	KATSARSKI Teodor	BUL	10

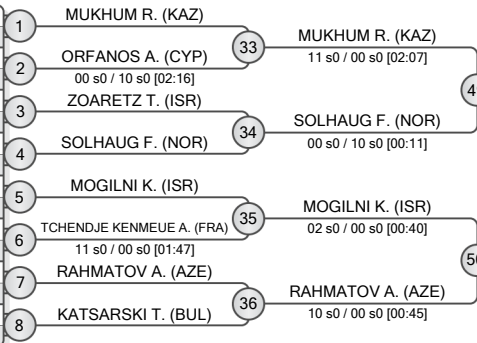

POOL B

	BUMAZKINS Jelisejs	LAT	11
	MARKOVIC Matija	MNE	12
	NTAVITANTZE Loukas	GRE	13
	MAN Darius	ROU	14
	ABBASALI Mahammad	AZE	15
	GELASHVILI Levan	GEO	16
	SHNIDER Omer	ISR	17
	GIANNAKOS Dimitrios	GRE	18
	SARGHEOLIU Alexandru	MDA	19

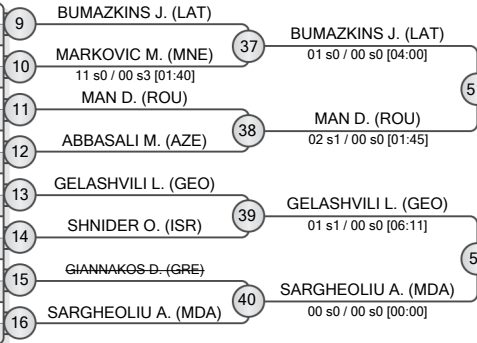

POOL C

	BABAICENKO Tajus	LTU	21
	LARIOS Anastasios	GRE	22
	FOGEL Alon	ISR	23
	BAKHTADZE Tshotne	GEO	24
	CHARALAMPOUS Miltiadis	CYP	25
	GARAGAU Razvan	ROU	26
	TSANTEKOV Achilles	GRE	27
	AYDOGU Mehmet Ali	TUR	28
	NIANE Elias	NOR	29

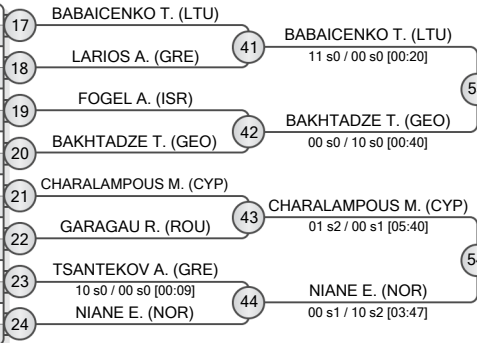

POOL D

	JACENKO Arturs	LAT	31
	MLADENOVIC Andrija	SRB	32
	BOUNTANIOTIS Georgios	GRE	33
	LAZAROV Ventsislav	BUL	34
	ACHLOW Boaz	ISR	35
	CAPEZZUTO Antonio	ITA	36
	NAPSO Aslan	ISR	37
	IAKOVOU Michalis	CYP	38
	MEHDIYEV Amin	AZE	39
	BESTAEV Dionysis	GRE	40

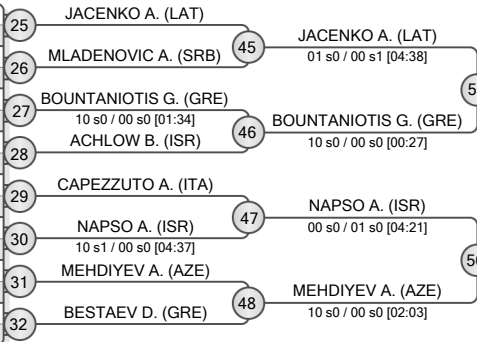

FINAL RESULTS		
1.	MUKHUM Rassul	KAZ
2.	BABAICENKO Tajus	LTU
3.	MEHDIYEV Amin	AZE
4.	BAKHTADZE Tshotne	GEO
5.	RAHMATOV Abdullah	AZE
6.	BUMAZKINS Jelisejs	LAT
7.	GELASHVILI Levan	GEO
8.	NAPSO Aslan	ISR

REPECHAGE

61	ORFANOS A. (CYP)	65	SOLHAUG F. (NOR)
62	MARKOVIC M. (MNE)	66	MAN D. (ROU)
63	LARIOS A. (GRE)	67	BAKHTADZE T. (GEO)
64	BESTAEV D. (GRE)	68	NAPSO A. (ISR)

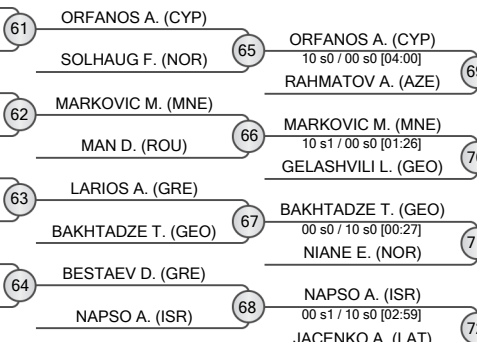



Thessaloniki Cadet European Cup 2024

Greece, Thessaloniki, 23-24 Nov 2024

-90 kg

Men (21)

POOL A

	KONCILIJIA Dan	CRO
	SIMON Viktor	MNE
	PRENTZAS Pavlos	GRE
	PRUIDZE Saba	GEO
	GAL Ofri	ISR
	VALENTIN Jeremy	LUX

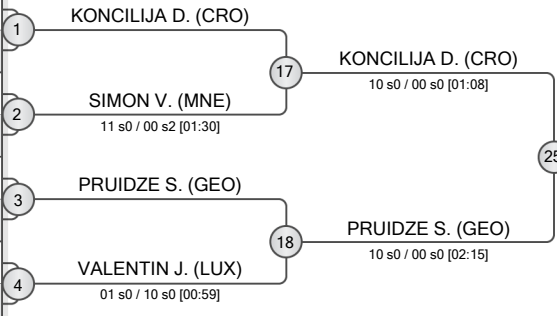

POOL B

	VUJICA Marko	CRO
	NAZLIS Dimitrios	GRE
	STANEV Zdravko	BUL
	DJINKIC Ivano	BIH
	SHOSHIN Nikita	IJF

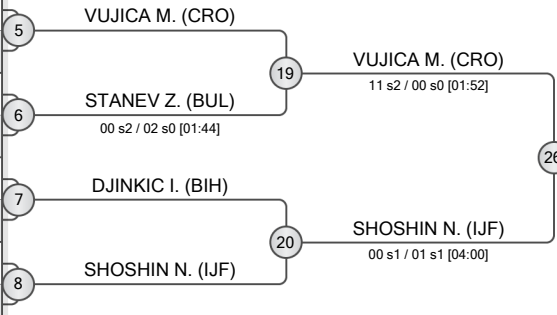

POOL C

	MILICEVIC Ivan	BIH
	RADULOVIC Jovan	MNE
	PASZEK Damian	POL
	HUSEYNOV Said	AZE
	KARAKLIDIS Gkiorgki	GRE

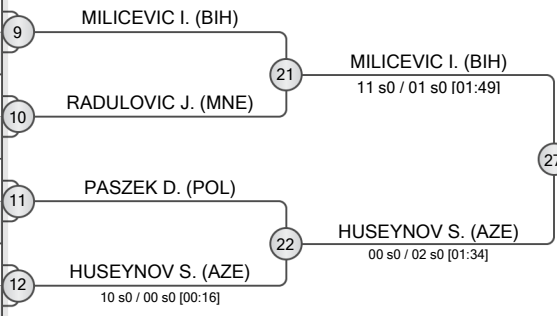

POOL D

	SIMIC Nemanja	SRB
	TZAGKIDIS Nikolaos	GRE
	SUNDBY Marius	NOR
	JURILJ Simun	CRO
	NEACSU Rares	ROU

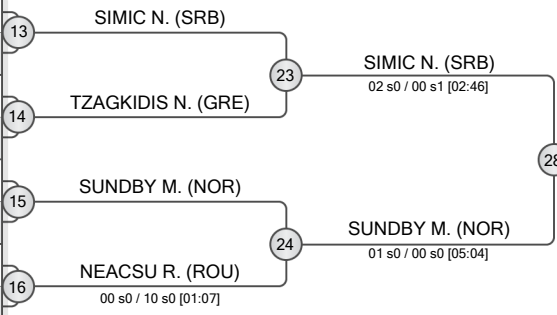

REPECHAGE

29	SIMON V. (MNE)	30	DJINKIC I. (BIH)	31	RADULOVIC J. (MNE)	32	TZAGKIDIS N. (GRE)
33	PRUIDZE S. (GEO)	34	VUJICA M. (CRO)	35	HUSEYNOV S. (AZE)	36	SUNDBY M. (NOR)

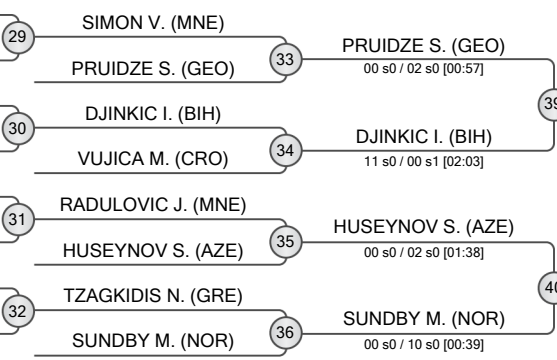

FINAL RESULTS	
1.	SHOSHIN Nikita IJF
2.	MILICEVIC Ivan BIH
3.	DJINKIC Ivano BIH
3.	SUNDBY Marius NOR
5.	SIMIC Nemanja SRB
7.	KONCILIJIA Dan CRO
7.	PRUIDZE Saba GEO
7.	HUSEYNOV Said AZE





Thessaloniki Cadet European Cup 2024

Greece, Thessaloniki, 23-24 Nov 2024

+ 90 kg

Men (12)

POOL A

	AKHUNDOV Subhan	AZE
	BAZARKATOV Yeraly	KAZ
	CUIBUS Raul	ROU

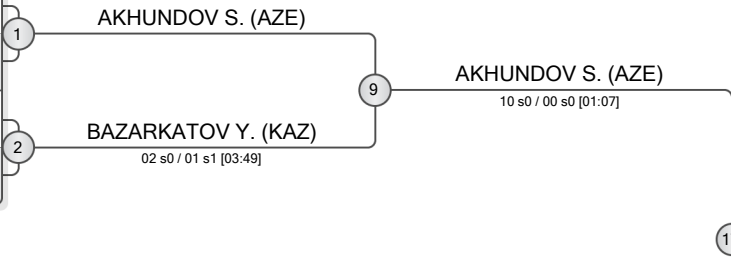

POOL B

	CORKOVIC Filip	SRB
	MASIMOV Javidan	AZE
	GULARASHVILI Viktor	GRE

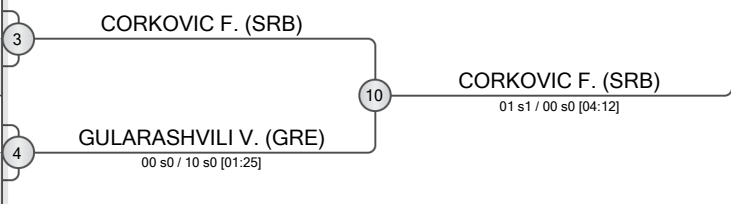

POOL C

	IVANKOVIC Luka	CRO
	ZARAFONITIS Alexios-Paisios	GRE
	FARZALIYEV Tunar	AZE

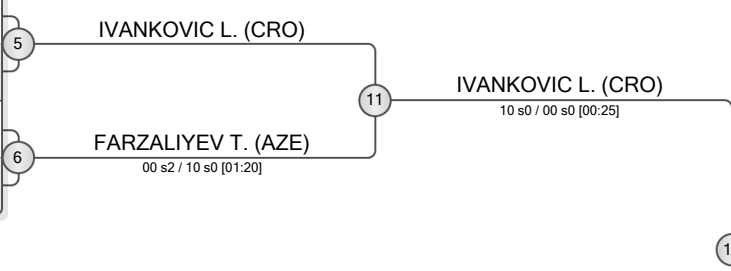

POOL D

	NOVAKOVIC Petar	SRB
	ZHAUDINOV Adilzhan	KAZ
	MALJEVIC Emir	MNE

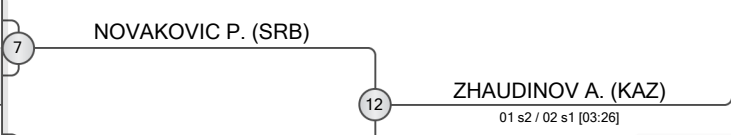

FINAL RESULTS		
1.	AKHUNDOV Subhan	AZE
2.	IVANKOVIC Luka	CRO
3.	ZHAUDINOV Adilzhan	KAZ
5.	BAZARKATOV Yeraly	KAZ
5.	CORKOVIC Filip	SRB
7.	GULARASHVILI Viktor	GRE
7.	NOVAKOVIC Petar	SRB

REPECHAGE

13	BAZARKATOV Y. (KAZ)
14	GULARASHVILI V. (GRE)
15	FARZALIYEV T. (AZE)
16	MALJEVIC E. (MNE)
16	NOVAKOVIC P. (SRB)

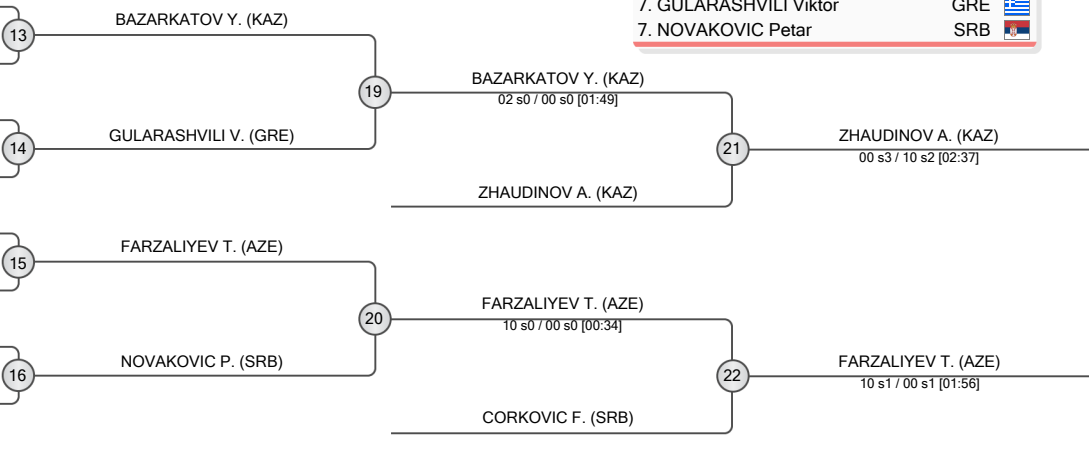

POOL A

	GABAY Yuval	ISR
	VASILEVA Raya	BUL
	FERRO Aurora	ITA

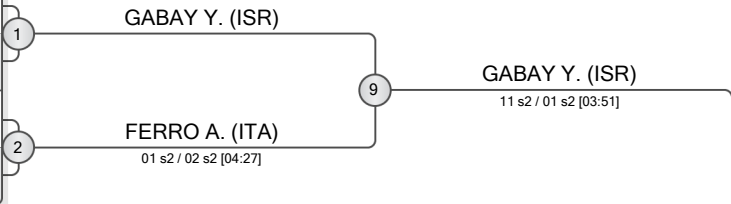

POOL B

	CONI Sara	GBR
	TOKMAK Havva Sena	TUR
	TSOTSKOLAURI Khatia	GEO
	COSTESCU Sabryna	ROU

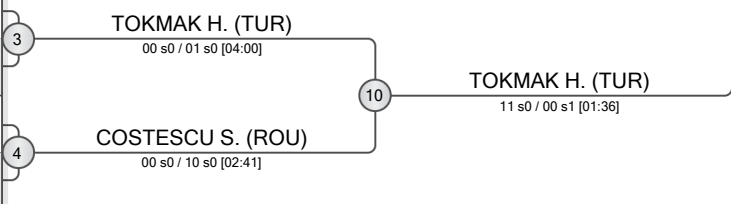

POOL C

	SERBAN Denisa	ROU
	VASILEVA Ema	BUL
	BASAK Vuslat	TUR
	AUREL Mathilde	FRA

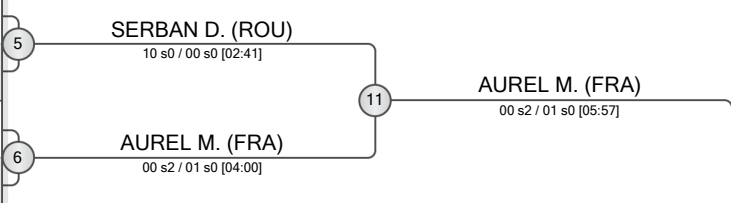

POOL D

	IASHVILI Natali	GEO
	MEKI Fatma Zehra	TUR
	LONGO Sofia	ITA
	CHRISTOFOROU Christina	CYP

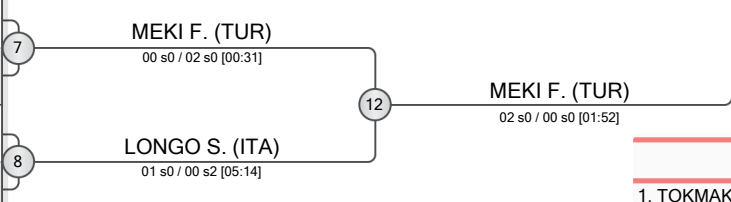

FINAL RESULTS		
1.	TOKMAK Havva Sena	TUR
2.	MEKI Fatma Zehra	TUR
3.	AUREL Mathilde	FRA
3.	GABAY Yuval	ISR
5.	CONI Sara	GBR
5.	SERBAN Denisa	ROU
7.	FERRO Aurora	ITA
7.	LONGO Sofia	ITA

REPECHAGE

13	FERRO A. (ITA)	19	CONI S. (GBR)	21	AUREL M. (FRA)
14	CONI S. (GBR)	20	SERBAN D. (ROU)	22	GABAY Y. (ISR)
15	SERBAN D. (ROU)	21	CONI S. (GBR)	22	GABAY Y. (ISR)
16	LONGO S. (ITA)	22	LONGO S. (ITA)		

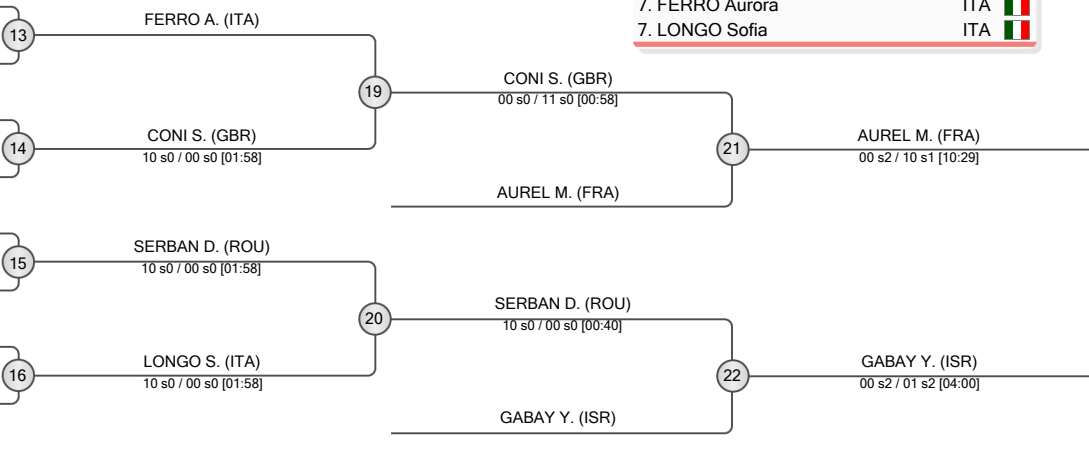



Thessaloniki Cadet European Cup 2024

Greece, Thessaloniki, 23-24 Nov 2024

-48 kg

Women (27)

POOL A

	HERTA Gabriela	MDA
	RUSLANOVA Assel	KAZ
	CHAIYOU Konstantina	GRE
	MILHAVET Agathe	FRA
	BLAZHESKA Georgina	MKD
	PANTSKHAVA Nini	GEO
	KOVACHEVA Preslava	BUL

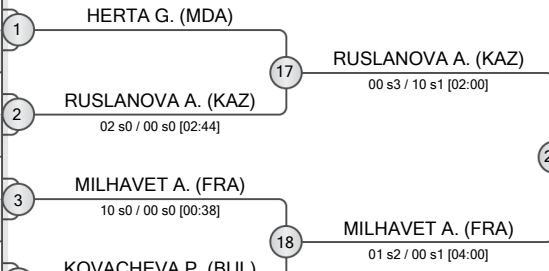

POOL B

	CULJAK Petra	BIH
	MARKOU Maria Eleni	GRE
	ERCIN Rahime	TUR
	BROVOLD Selma	NOR
	MUNTEANU Ana Maria	ROU
	PAPATHEODOROU Evangelia	GRE

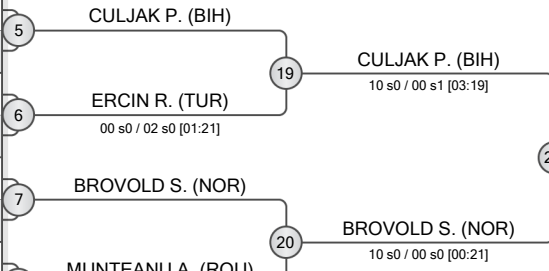

POOL C

	SHYNGGYSKHAN Gul Khan	KAZ
	IDDIR Celine	FRA
	STAVROPOULOU Iliana	GRE
	CHRISP Taylor	GBR
	ANTOVA Zoya	BUL
	STOJMILOVSKA Anamarija	MKD
	NESHER Zimri	ISR

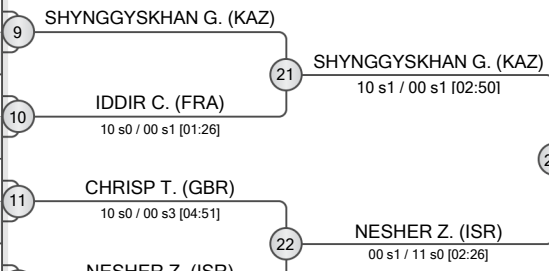

POOL D

	PODYMSKA Nina	POL
	RASIC Mara	SRB
	ANVAROVA Aidana	KAZ
	LETONIA Dora	CRO
	GRIGOROVA Kalina	BUL
	AMAXOPOULOU Nina	GRE
	VANDAELE Aiana	FRA

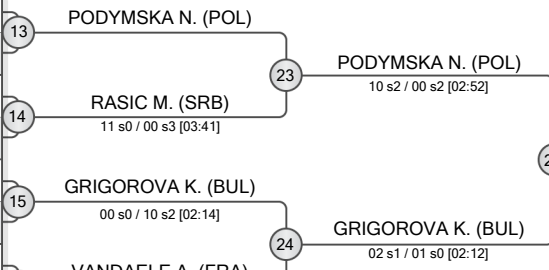

REPECHAGE

CHAIYOU K. (GRE)	29	CHAIYOU K. (GRE)	33	MILHAVET A. (FRA)
HERTA G. (MDA)		MILHAVET A. (FRA)		
ERCIN R. (TUR)	30	ERCIN R. (TUR)	34	MILHAVET A. (FRA)
		BROVOLD S. (NOR)		
IDDIR C. (FRA)	31	IDDIR C. (FRA)	35	MILHAVET A. (FRA)
		NESHER Z. (ISR)		
RASIC M. (SRB)	32	RASIC M. (SRB)	36	MILHAVET A. (FRA)
		GRIGOROVA K. (BUL)		

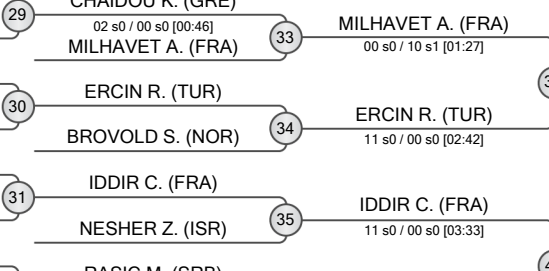

SHYNGGYSKHAN G. (KAZ) [03:38]

SHYNGGYSKHAN G. (KAZ) [03:45]

FINAL RESULTS	
1.	SHYNGGYSKHAN Gul Khan (KAZ)
2.	RUSLANOVA Assel (KAZ)
3.	MILHAVET Agathe (FRA)
3.	IDDIR Celine (FRA)
5.	PODYMSKA Nina (POL)
5.	CULJAK Petra (BIH)
7.	ERCIN Rahime (TUR)
7.	RASIC Mara (SRB)





Thessaloniki Cadet European Cup 2024

Greece, Thessaloniki, 23-24 Nov 2024

-52 kg

Women (25)

POOL A

	SAVIC Bojana	SRB
	LOPEZ Alice	FRA
	LO TUFO Ilenia	ITA
	TEISANU Teodora	ROU
	TZAMPARLI Maria	GRE
	ASHKENAZI Shay	ISR
	BILBA Victoria	MDA

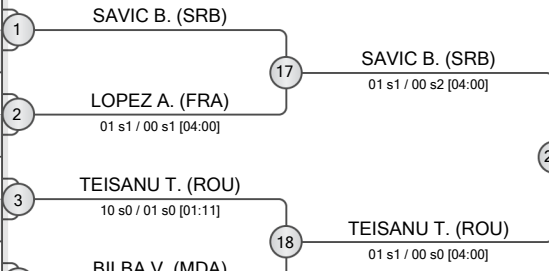

POOL B

	DI LEONARDO Noemi	ITA
	TOMESCU Yasmine	ROU
	TODOROVIC Andjela	SRB
	YAHAV Yali	ISR
	KOYAK Aleyna Sena	TUR
	JURAS Nala	CRO

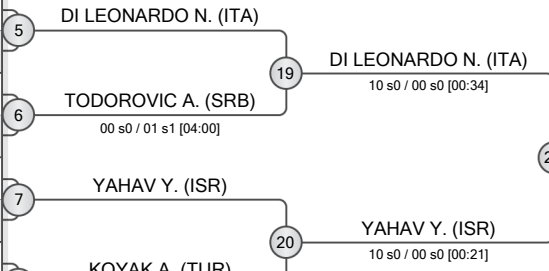

POOL C

	TATRISHVILI Sopio	GEO
	KANELLOPOULOU Aikaterini	GRE
	STOEVA Andrea	BUL
	FIROTTTO Chiara	ITA
	KUBERSKY Lia	ISR
	RAIC Gabriela	BIH

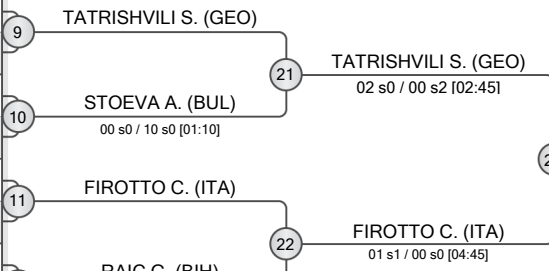

POOL D

	HAMDAOUI Dina-Syrine	FRA
	DIAS Kiara	LUX
	IATAGAN Maria	ROU
	PAPADOPOULOU Eirini-Kleio	GRE
	BRODALA Helena	POL
	SIMIC Andjela	SRB

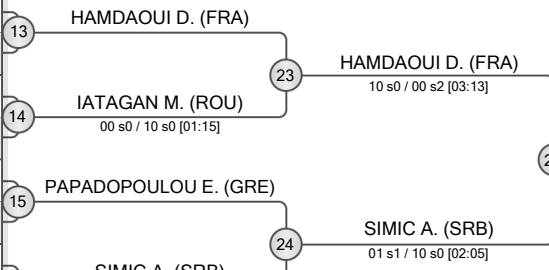

REPECHAGE

LOPEZ A. (FRA)	29	LOPEZ A. (FRA)	33
KOYAK A. (TUR)	30	DI LEONARDO N. (ITA)	34
STOEVA A. (BUL)	31	FIROTTTO C. (ITA)	35
IATAGAN M. (ROU)	32	IATAGAN M. (ROU)	36

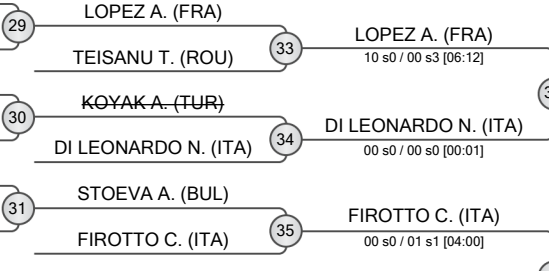

FINAL RESULTS	
1. SAVIC Bojana	SRB
2. TATRISHVILI Sopio	GEO
3. LOPEZ Alice	FRA
3. YAHAV Yali	ISR
5. HAMDAOUI Dina-Syrine	FRA
5. FIROTTTO Chiara	ITA
7. IATAGAN Maria	ROU





Thessaloniki Cadet European Cup 2024

Greece, Thessaloniki, 23-24 Nov 2024

-57 kg

Women (30)

POOL A

	SORELLI Giulia	ITA
	KOVACI Krista	ALB
	KADIC Ira	CRO
	GLIGA Ana	ROU
	HADAR Noa	ISR
	DAVAZE Isaure	FRA
	KESIDOU Christina	GRE

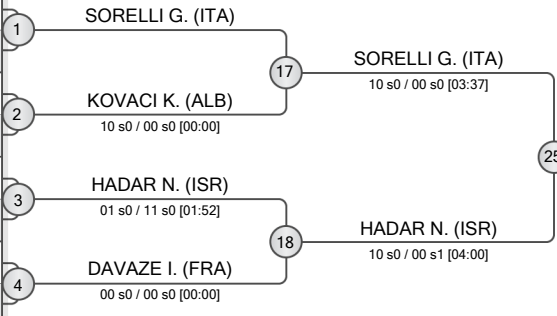

POOL B

	AZINOU Marina	CYP
	KRAUS Daria	ROU
	PAPADOPOULOU Despoina	GRE
	TRAAVIK Asal	NOR
	DUDKO Aleksandra	GBR
	CVETKOVIC Jana	SRB
	GAMIASHVILI Tamar	GEO
	CESLAUSKAITE Deimante	LTU

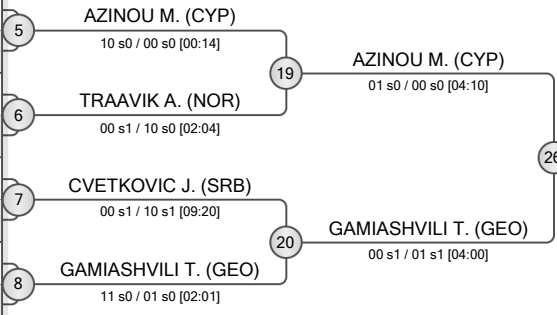

POOL C

	CAPEZZUTO Martina	ITA
	JASIKOVAC Nikolina	BIH
	CHRISTOPOULOU Evdokia	GRE
	PKHAKADZE Barbara	GEO
	TRIFKOVIC Iva	SRB
	PERY Noa	ISR
	REVEILLON Louanne	FRA

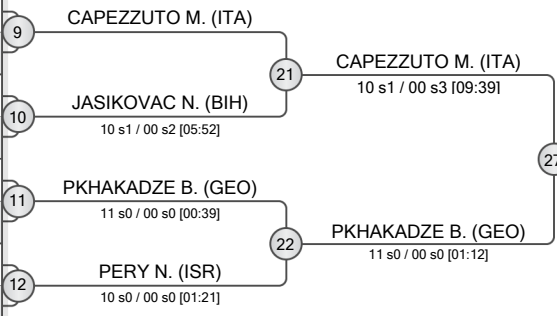

POOL D

	VEINHANDL OBAID Haya	SLO
	KAKARANTZA Ioanna	GRE
	STAIKU Patricia	ROU
	DOS REIS Constance	FRA
	SKOMERSIC Maria	CRO
	SEKULOVIC Milena	SRB
	KHEGAY Kira	KAZ
	BESTAV Selin	TUR

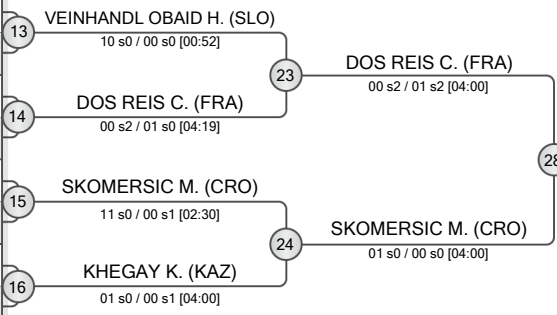

FINAL RESULTS	
1.	CAPEZZUTO Martina ITA
2.	GAMIASHVILI Tamar GEO
3.	AZINOU Marina CYP
3.	DOS REIS Constance FRA
5.	SKOMERSIC Maria CRO
7.	HADAR Noa ISR
7.	GLIGA Ana ROU
7.	PKHAKADZE Barbara GEO

REPECHAGE

GLIGA A. (ROU)	29	GLIGA A. (ROU)	33
DAVAZE I. (FRA)		SORELLI G. (ITA)	
CESLAUSKAITE D. (LTU)			
CVETKOVIC J. (SRB)	30	CESLAUSKAITE D. (LTU)	34
		AZINOU M. (CYP)	
JASIKOVAC N. (BIH)	31	JASIKOVAC N. (BIH)	35
SEKULOVIC M. (SRB)		PKHAKADZE B. (GEO)	
KHEGAY K. (KAZ)	32	KHEGAY K. (KAZ)	36
		DOS REIS C. (FRA)	

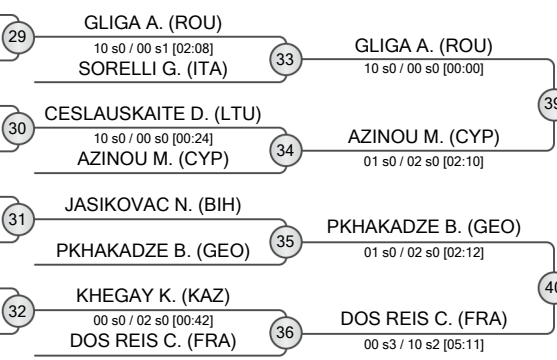



Thessaloniki Cadet European Cup 2024

Greece, Thessaloniki, 23-24 Nov 2024

-63 kg

Women (25)

POOL A

	MATSIRIDI Sophia	GRE
	UNGUREANU Bianca	ROU
	HUBERT Prisca	FRA
	IMERI Sara	CRO
	RUBANOVICI Dorina	MDA
	CHRISAKI Anni-Iris	GRE
	COVIC STANIC Lana	BIH

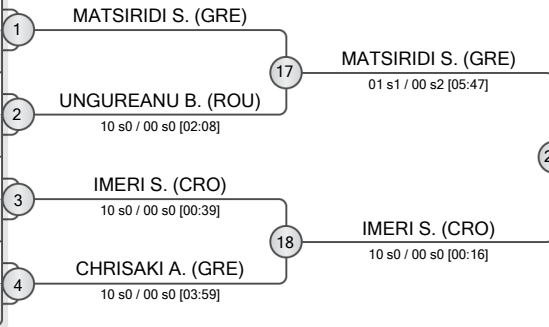

POOL B

	BOGDANOVSKA Iva	MKD
	MATSIRIDI Drosia	GRE
	JOVICIC Sofija	SRB
	THOMSON Maia	CAN
	MITEVA Elizabeth	BUL
	PAPASTERGIOU Anna	GRE

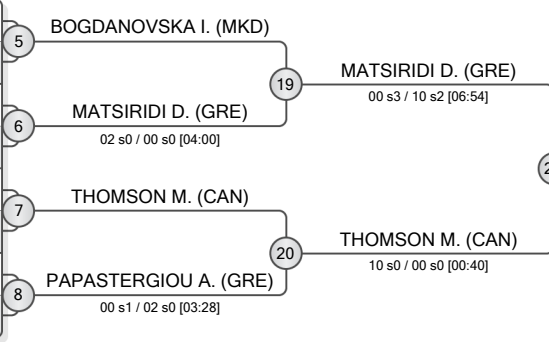

POOL C

	NATELAURI Mariam	GEO
	DIALLO Malika	FRA
	IMERI Esra	CRO
	GRAMBO Anna	NOR
	DOUROU Lydia	GRE
	FROSONI Giorgia	ITA

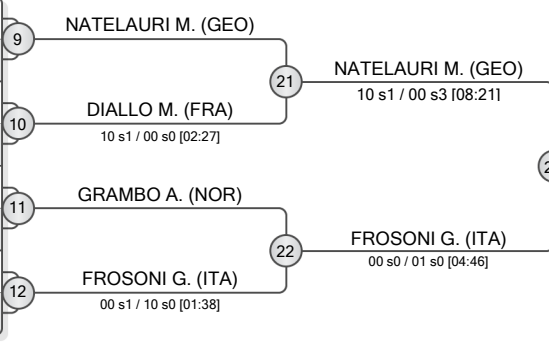

POOL D

	DALMASSO Madeleine	FRA
	OURANITSA Chrysoula-Stavroula	GRE
	TODOROVA Elitsa	BUL
	AUBERT GOMEZ Maya	GBR
	AKRIVOULI Efthymia	GRE
	LULEDZIJA Marija	BIH

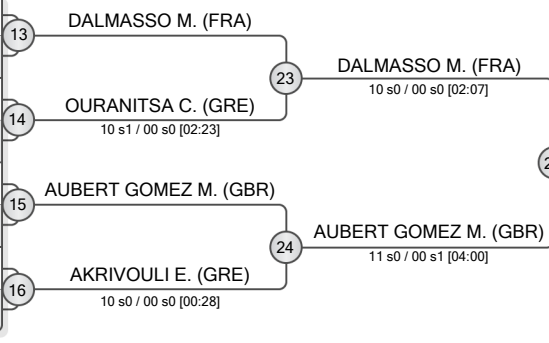

REPECHAGE

	RUBANOVICI D. (MDA)	
	CHRISAKI A. (GRE)	
	PAPASTERGIOU A. (GRE)	
	DOUROU L. (GRE)	
	GRAMBO A. (NOR)	
	OURANITSA C. (GRE)	

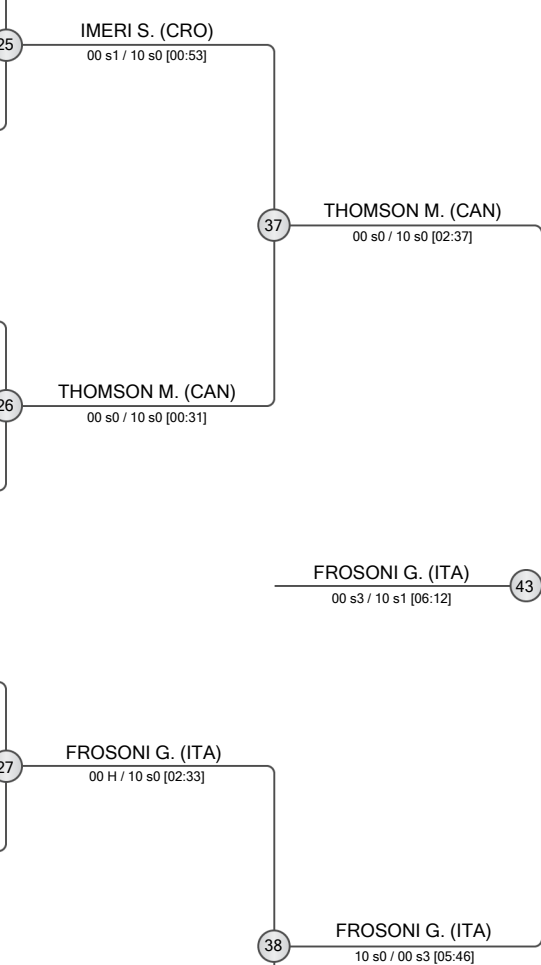
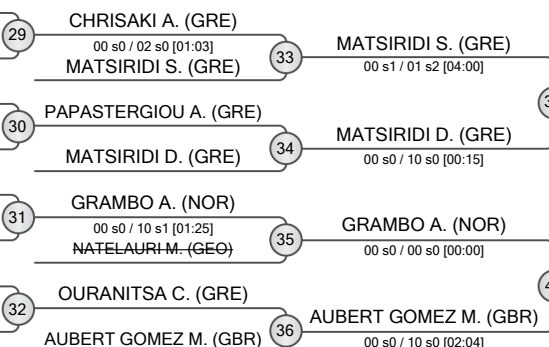

FINAL RESULTS	
1. FROSONI Giorgia	ITA
2. THOMSON Maia	CAN
3. DALMASSO Madeleine	FRA
3. AUBERT GOMEZ Maya	GBR
5. MATSIRIDI Sophia	GRE
5. IMERI Sara	CRO
7. MATSIRIDI Drosia	GRE
7. GRAMBO Anna	NOR



Thessaloniki Cadet European Cup 2024

Greece, Thessaloniki, 23-24 Nov 2024

-70 kg

Women (14)

POOL A

	SLACEK Nika	CRO
	PAPAIOANNOU Maria Eleni	GRE
	VLAHOVIC Teodora	MNE

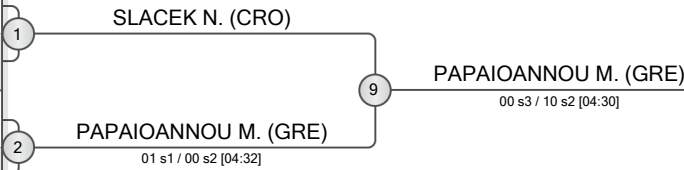

POOL B

	KLINGER Johanna Elisabeth	BIH
	MICHAIL Maria	CYP
	HUDIKA Vita	CRO
	KURDGELIA Elene	GEO

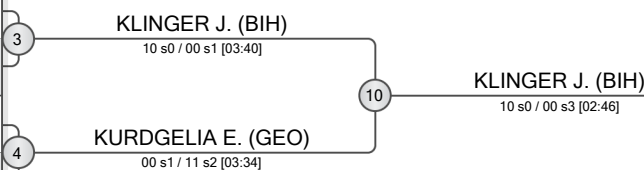

POOL C

	ROBAKIDZE Ket	GEO
	MARKHVAIDZE Lizi	GEO
	KNAFELC Noeli	SLO

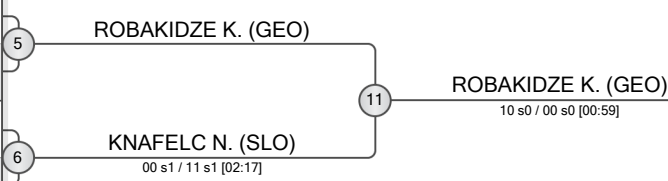

POOL D

	DZIDIC Korina	BIH
	ILIC Sara	SRB
	MITAKIDOU Ilektra-Evangelia	GRE
	APETREI Marianne Alexandra	ITA

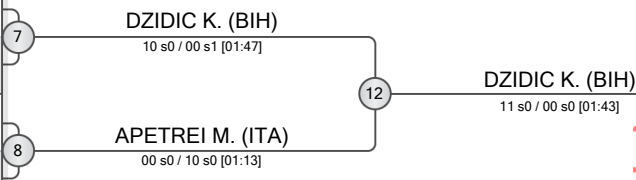

REPECHAGE

VLAHOVIC T. (MNE)	13
SLACEK N. (CRO)	14
MICHAIL M. (CYP)	15
KURDGELIA E. (GEO)	16
KNAFELC N. (SLO)	17
ILIC S. (SRB)	18
APETREI M. (ITA)	19

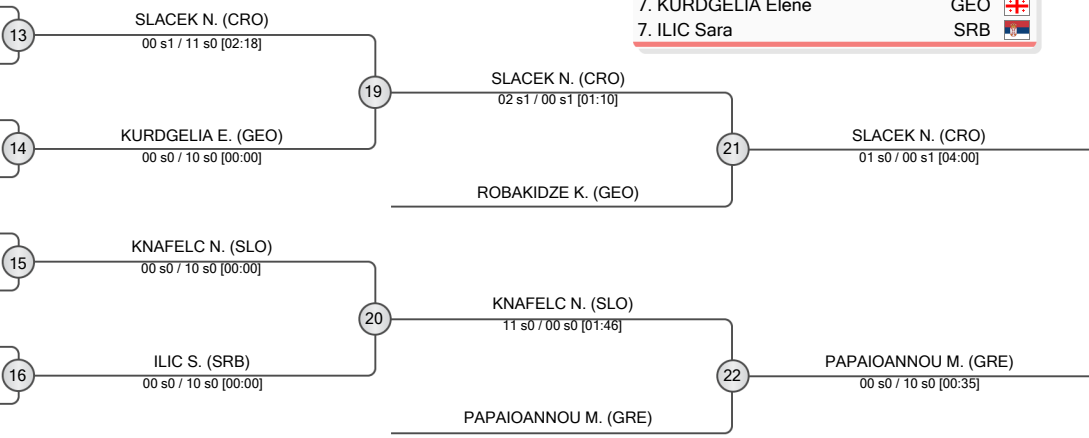

FINAL RESULTS

1. DZIDIC Korina	BIH	
2. KLINGER Johanna Elisabeth	BIH	
3. SLACEK Nika	CRO	
3. PAPAIOANNOU Maria Eleni	GRE	
5. ROBAKIDZE Ket	GEO	
5. KNAFELC Noeli	SLO	
7. KURDGELIA Elene	GEO	
7. ILIC Sara	SRB	



POOL A

	KVARATSKHELIA Nona	GEO
	OGKANESIAN Natalia	GRE

POOL B

	REPIAKH Aleksandra	IJF
	CHERKELIEVA Maria	BUL

POOL C

	SCHIAVON Carlotta	ITA
	KAPIANIDZE Nia	GEO

POOL D

	NIKETIC Leona	CRO
	KAJTAZOVIC Danijela	BIH

REPECHAGE

OGKANESIAN N. (GRE)	7	CHERKELIEVA M. (BUL)
CHERKELIEVA M. (BUL)		00 s0 / 02 s1 [02:58]
KAPIANIDZE N. (GEO)	8	NIKETIC L. (CRO)
NIKETIC L. (CRO)		00 s0 / 10 s0 [01:21]

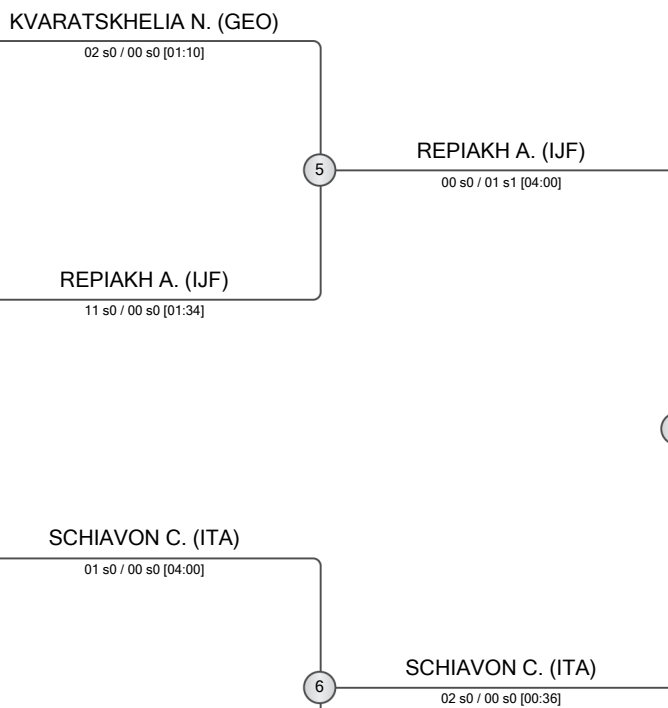

FINAL RESULTS		
1.	REPIAKH Aleksandra	IJF
2.	SCHIAVON Carlotta	ITA
3.	CHERKELIEVA Maria	BUL
3.	KVARATSKHELIA Nona	GEO
5.	KAJTAZOVIC Danijela	BIH
5.	NIKETIC Leona	CRO