



# European Judo Championships of the Small States 2024 Cadets

Cyprus, Nicosia, 2 Nov 2024

**-50 kg**  
Men (3)

Num.	Competitor	State	1	2	3	Wins	Points
1.	TROULLIDES Nasos	Cyprus		1	0	0	1
2.	FELLOUKA Loizos	Cyprus	10		0	1	10
3.	MARCHIORI Ugo	Luxembourg	1	10		2	11

TROULLIDES Nasos	CYP
FELLOUKA Loizos	CYP

1

FELLOUKA L. (CYP)

01 s0 / 10 s1 [02:15]

FINAL RESULTS		
1. MARCHIORI Ugo	LUX	
2. FELLOUKA Loizos	CYP	

TROULLIDES Nasos	CYP
MARCHIORI Ugo	LUX

2

MARCHIORI U. (LUX)

00 s1 / 01 s1 [04:00]

FELLOUKA Loizos	CYP
MARCHIORI Ugo	LUX

3

MARCHIORI U. (LUX)

00 s3 / 10 s0 [03:50]

MARCHIORI Ugo	LUX
FELLOUKA Loizos	CYP

4

MARCHIORI U. (LUX)

02 s1 / 00 s2 [03:26]





# European Judo Championships of the Small States 2024 Cadets

Cyprus, Nicosia, 2 Nov 2024

**-55 kg**  
Men (3)

Num.	Competitor	State	1	2	3	Wins	Points
1.	CHARALAMPOUS Stratos	Cyprus		10	1	2	11
2.	SOFOKLEOUS Sofoklis	Cyprus	0		1	0	1
3.	FOSER Nik	Liechtenstein	0	10		1	10

CHARALAMPOUS Stratos	CYP
SOFOKLEOUS Sofoklis	CYP

1 CHARALAMPOUS S. (CYP)  
02 s0 / 00 s0 [03:07]

FINAL RESULTS		
1. CHARALAMPOUS Stratos	CYP	
2. FOSER Nik	LIE	

CHARALAMPOUS Stratos	CYP
FOSER Nik	LIE

2 CHARALAMPOUS S. (CYP)  
01 s1 / 00 s0 [04:00]

SOFOKLEOUS Sofoklis	CYP
FOSER Nik	LIE

3 FOSER N. (LIE)  
01 s0 / 10 s0 [01:15]

CHARALAMPOUS Stratos	CYP
FOSER Nik	LIE

4 CHARALAMPOUS S. (CYP)  
02 s0 / 00 s1 [01:42]





# European Judo Championships of the Small States 2024 Cadets

Cyprus, Nicosia, 2 Nov 2024

## -60 kg

Men (6)

POOL A

STAVROU Christos CYP

STAVROU C. (CYP)

POOL B

GILABERT Joanet AND

AFXENTIOU Afxentis CYP

AFXENTIOU A. (CYP)

00 s0 / 11 s0 [01:23]

POOL C

GRAY Kjartan FRO

GRAY K. (FRO)

POOL D

HADJIYIANNIS Nestoras CYP

MOUSIKOS Nikolas CYP

HADJIYIANNIS N. (CYP)

10 s2 / 01 s0 [04:00]

REPECHAGE

GILABERT J. (AND)

GILABERT J. (AND)

MOUSIKOS N. (CYP)

MOUSIKOS N. (CYP)

AFXENTIOU A. (CYP)

1

7

STAVROU C. (CYP)

01 s0 / 00 s2 [04:00]

2

3

8

HADJIYIANNIS N. (CYP)

00 s1 / 11 s0 [01:57]

4

5

9

GILABERT J. (AND)

01 s2 / 00 s0 [04:00]

6

10

AFXENTIOU A. (CYP)

01 s2 / 00 s0 [04:00]

11

STAVROU C. (CYP)

11 s1 / 00 s0 [02:41]

### FINAL RESULTS

- STAVROU Christos CYP
- HADJIYIANNIS Nestoras CYP
- GILABERT Joanet AND
- AFXENTIOU Afxentis CYP
- GRAY Kjartan FRO
- MOUSIKOS Nikolas CYP





# European Judo Championships of the Small States 2024 Cadets

Cyprus, Nicosia, 2 Nov 2024

**-66 kg**  
Men (5)

Num.	Competitor	State	1	3	5	Wins	Points
1.	KAGLATZIS Panagiotis	Cyprus		10	10	2	20
3.	HADJISAVVAS Georgios	Cyprus	0		10	1	10
5.	ZENIOU Nikos	Cyprus	0	0		0	0

Num.	Competitor	State	2	4	Wins	Points
2.	GEORGIOU Konstantinos	Cyprus		10	1	10
4.	WARDE JONES Ben	Luxembourg	0		1	10

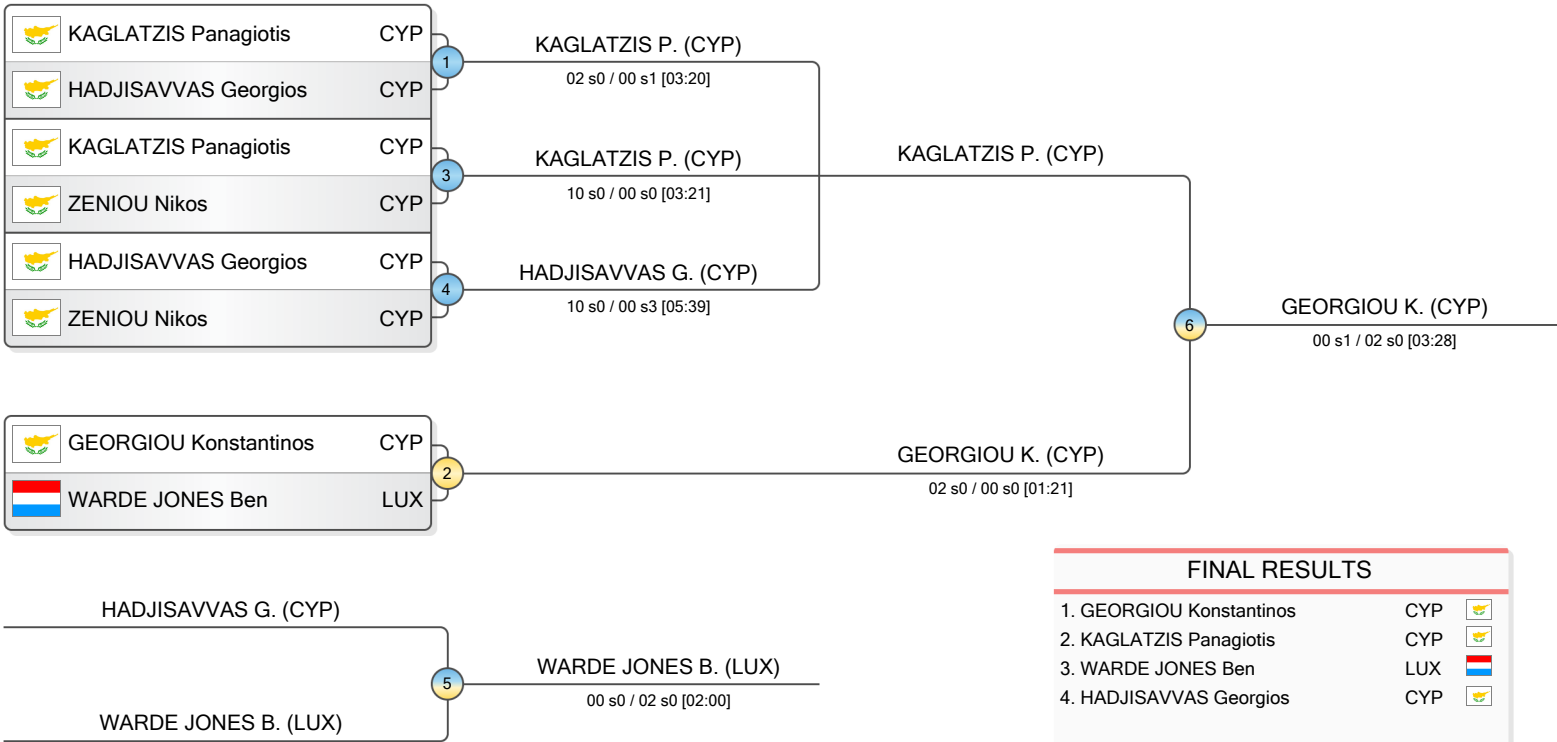

FINAL RESULTS		
1.	GEORGIOU Konstantinos	CYP
2.	KAGLATZIS Panagiotis	CYP
3.	WARDE JONES Ben	LUX
4.	HADJISAVVAS Georgios	CYP





# European Judo Championships of the Small States 2024 Cadets

Cyprus, Nicosia, 2 Nov 2024

# -73 kg

## Men (7)

POOL A

	POLYKARPOU Paris	CYP

POLYKARPOU P. (CYP)

POOL B

	PSENICNIJS Romans	ISL
	CHARALAMPOUS Vladimiros	CYP

CHARALAMPOUS V. (CYP)

POOL C

	SPETSIOS Kyriakos	CYP
	MEIER Gabriel	LIE

SPETSIOS K. (CYP)

POOL D

	LAZARIDES Stefanos	CYP
	REBELO OSORIO Marcos	LUX

LAZARIDES S. (CYP)

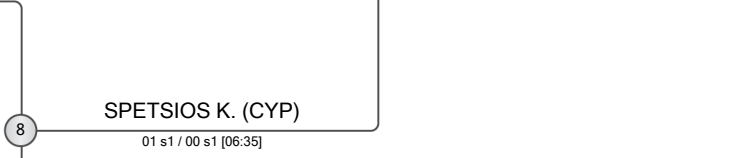
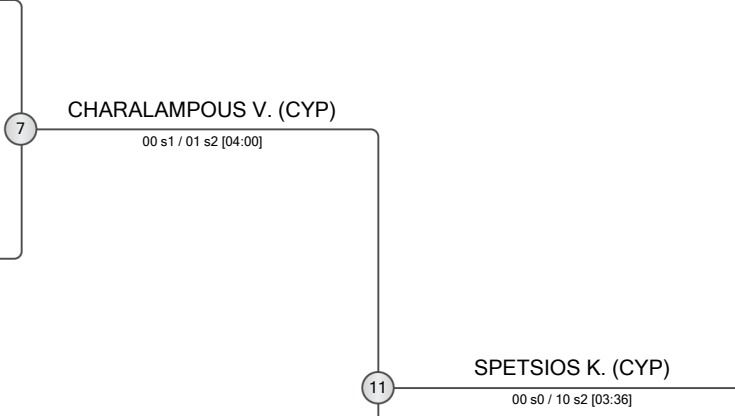

FINAL RESULTS		
1.	SPETSIOS Kyriakos	CYP
2.	CHARALAMPOUS Vladimiros	CYP
3.	LAZARIDES Stefanos	CYP
3.	REBELO OSORIO Marcos	LUX
5.	PSENICNIJS Romans	ISL
5.	POLYKARPOU Paris	CYP

REPECHAGE

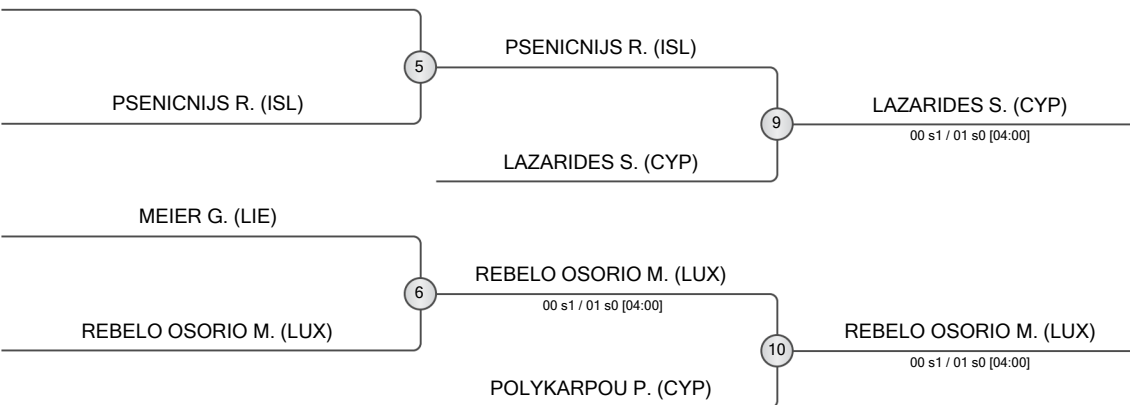



POOL A  
POOL B

	CHARALAMPOUS Miltiadis	CYP
	BALLESTE Jan	AND

CHARALAMPOUS M. (CYP)  
02 s0 / 00 s0 [01:23]

POOL C  
POOL D

	ORFANOS Athanasios	CYP
	IAKOVOU Michalis	CYP

IAKOVOU M. (CYP)  
00 s0 / 01 s1 [07:03]

REPECHAGE

BALLESTE J. (AND)
ORFANOS A. (CYP)

ORFANOS A. (CYP)  
00 s0 / 10 s0 [00:42]

IAKOVOU M. (CYP)  
00 s3 / 11 s0 [02:57]

FINAL RESULTS		
1. IAKOVOU Michalis	CYP	
2. CHARALAMPOUS Miltiadis	CYP	
3. ORFANOS Athanasios	CYP	

Num.	Competitor	State	1	2	3	Wins	Points
1.	CHRISTOFIDES Ioannis	Cyprus		0	0	0	0
2.	DIMITRIOU Marios	Cyprus	10		1	1	11
3.	VALENTIN Jeremy	Luxembourg	10	10		2	20

CHRISTOFIDES Ioannis	CYP	1	DIMITRIOU M. (CYP)
DIMITRIOU Marios	CYP		

00 s0 / 02 s0 [02:11]

FINAL RESULTS		
1. VALENTIN Jeremy	LUX	
2. DIMITRIOU Marios	CYP	

CHRISTOFIDES Ioannis	CYP	2	VALENTIN J. (LUX)
VALENTIN Jeremy	LUX		

00 s0 / 10 s0 [00:53]

DIMITRIOU Marios	CYP	3	VALENTIN J. (LUX)
VALENTIN Jeremy	LUX		

01 s1 / 10 s1 [03:48]

VALENTIN Jeremy	LUX	4	VALENTIN J. (LUX)
DIMITRIOU Marios	CYP		

10 s1 / 00 s1 [02:52]



Num.	Competitor	State	1	2	Wins	Points
1.	DEMETRIOU Alexantros	Cyprus		10	1	10
2.	KRALJEVSKI Mihail	Andorra	0		0	0

	DEMETRIOU Alexantros	CYP
	KRALJEVSKI Mihail	AND

1

DEMETRIOU A. (CYP)  
 10 s0 / 00 s0 [01:20]

FINAL RESULTS	
1. DEMETRIOU Alexantros	CYP







POOL A  
POOL B

CHRISTOFOROU Christina CYP

LOUCA Christina CYP

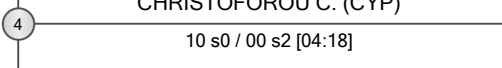
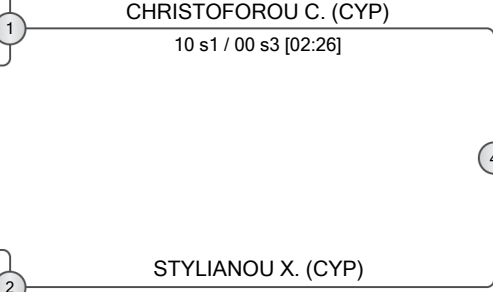

POOL C  
POOL D

STYLIANOU Xanthia CYP

ALEXANDROU Eirini CYP

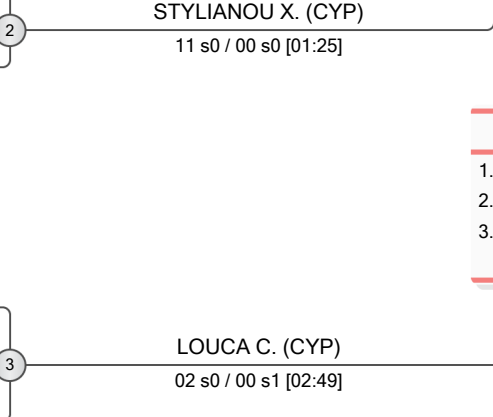

REPECHAGE

FINAL RESULTS		
1. CHRISTOFOROU Christina	CYP	
2. STYLIANOU Xanthia	CYP	
3. LOUCA Christina	CYP	





Num.	Competitor	State	1	2	Wins	Points
1.	DIAS Kiara	Luxembourg		0	0	0
2.	CHRISTODOULIDOU Adamantia	Cyprus	10		1	10

	DIAS Kiara	LUX
	CHRISTODOULIDOU Adamantia	CYP

1  
 CHRISTODOULIDOU A. (CYP)  
 00 s0 / 10 s0 [00:35]

FINAL RESULTS	
1. CHRISTODOULIDOU Adamantia	CYP



# European Judo Championships of the Small States 2024 Cadets

Cyprus, Nicosia, 2 Nov 2024

## -63 kg

### Women (6)

POOL A

SCHILLINGS Chloe LUX

SCHILLINGS C. (LUX)

POOL B

FJALLSBAK Josefina Ingibjorg FRO

AZINOU Marina CYP

AZINOU M. (CYP)

00 s0 / 11 s0 [00:27]

AZINOU M. (CYP)

00 s1 / 10 s0 [02:15]

POOL C

VASILIOU Sofia CYP

VASILIOU S. (CYP)

POOL D

BJARNADOTTIR Helena ISL

BORGARLID Frida FRO

BJARNADOTTIR H. (ISL)

10 s0 / 00 s0 [00:37]

BJARNADOTTIR H. (ISL)

00 s0 / 11 s0 [01:02]

AZINOU M. (CYP)

11 s0 / 00 s0 [02:44]

### FINAL RESULTS

1. AZINOU Marina	CYP	
2. BJARNADOTTIR Helena	ISL	
3. VASILIOU Sofia	CYP	
3. SCHILLINGS Chloe	LUX	
5. FJALLSBAK Josefina Ingibjorg	FRO	
5. BORGARLID Frida	FRO	

REPECHAGE

FJALLSBAK J. (FRO)

FJALLSBAK J. (FRO)

BORGARLID F. (FRO)

BORGARLID F. (FRO)

VASILIOU S. (CYP)

VASILIOU S. (CYP)

01 s0 / 10 s0 [02:06]

SCHILLINGS C. (LUX)

01 s0 / 10 s0 [02:06]





# European Judo Championships of the Small States 2024 Cadets

Cyprus, Nicosia, 2 Nov 2024

**-70 kg**  
Women (3)

Num.	Competitor	State	1	2	3	Wins	Points
1.	SUTOVIC Andrijana	Montenegro		0	10	2	10
2.	WELTER Leni	Luxembourg	0		0	0	0
3.	MICHAIL Maria	Cyprus	1	0		1	1

SUTOVIC Andrijana	MNE	1	SUTOVIC A. (MNE)
WELTER Leni	LUX		

00 s0 / 00 s0 [00:00]

FINAL RESULTS	
1. SUTOVIC Andrijana	MNE
2. MICHAIL Maria	CYP

SUTOVIC Andrijana	MNE	2	SUTOVIC A. (MNE)
MICHAIL Maria	CYP		

10 s0 / 01 s0 [01:04]

WELTER Leni	LUX	3	MICHAIL M. (CYP)
MICHAIL Maria	CYP		

00 s0 / 00 s0 [00:00]

SUTOVIC Andrijana	MNE	4	SUTOVIC A. (MNE)
MICHAIL Maria	CYP		

11 s0 / 00 s0 [01:51]





# European Judo Championships of the Small States 2024 Cadets

Cyprus, Nicosia, 2 Nov 2024

**+ 70 kg**  
Women (3)

Num.	Competitor	State	1	2	3	Wins	Points
1.	NEOKLEOUS Georgia	Cyprus		0	0	0	0
2.	ANDREOU Eirini	Cyprus	10		10	2	20
3.	CERRO Isona	Andorra	10	0		1	10

NEOKLEOUS Georgia	CYP
ANDREOU Eirini	CYP

1

ANDREOU E. (CYP)

00 s1 / 10 s1 [03:03]

FINAL RESULTS	
1. ANDREOU Eirini	CYP
2. CERRO Isona	AND

NEOKLEOUS Georgia	CYP
CERRO Isona	AND

2

CERRO I. (AND)

00 s0 / 02 s0 [01:16]

ANDREOU Eirini	CYP
CERRO Isona	AND

3

ANDREOU E. (CYP)

02 s2 / 00 s1 [03:29]

ANDREOU Eirini	CYP
CERRO Isona	AND

4

ANDREOU E. (CYP)

11 s2 / 00 s0 [01:31]



POOL A

ZAHRA James MLT

POOL B

KONSTANTINOOU Loukas CYP

KAMITSIS Alexandros CYP

POOL C

STAVROU Christos CYP

ARMENTA PALOMARES PERE AND

POOL D

STOJANOVIC Aleksa MLT

CHARALAMPOUS Stratos CYP

REPECHAGE

KAMITSIS A. (CYP)

ARMENTA PALOMARES P. (AND)

CHARALAMPOUS S. (CYP)

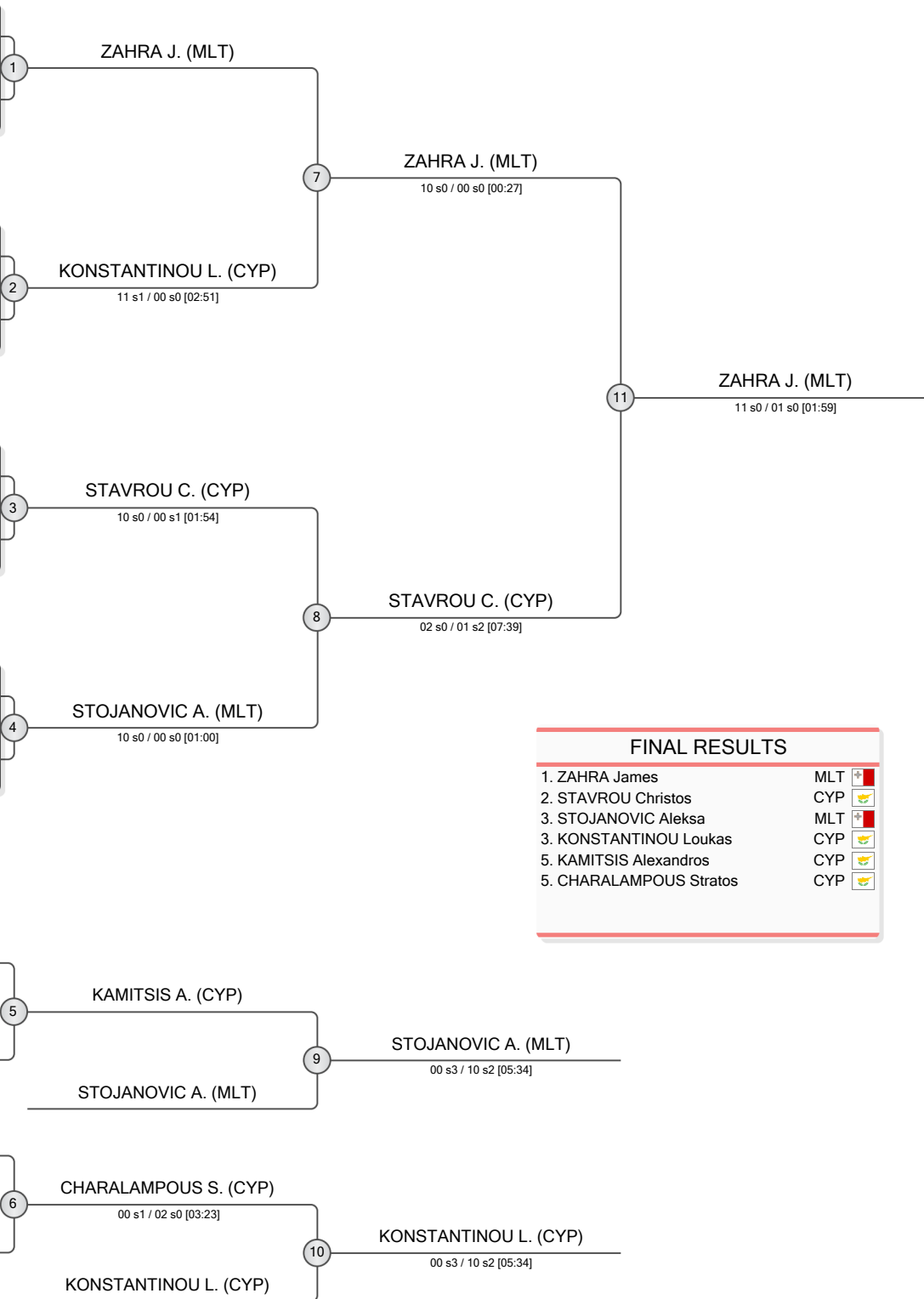

FINAL RESULTS		
1.	ZAHRA James	MLT
2.	STAVROU Christos	CYP
3.	STOJANOVIC Aleksa	MLT
3.	KONSTANTINOOU Loukas	CYP
5.	KAMITSIS Alexandros	CYP
5.	CHARALAMPOUS Stratos	CYP



POOL A

BALARJISHVILI Georgios CYP

GEORGIU Konstantinos CYP

POOL B

POOL C

CHRISTODOULIDES Petros CYP

KALAITSIDIS Georgios CYP

POOL D

REPECHAGE

GEORGIU K. (CYP)

KALAITSIDIS G. (CYP)

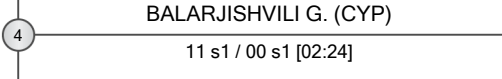
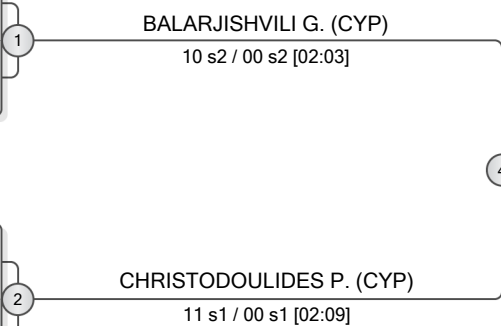

FINAL RESULTS		
1.	BALARJISHVILI Georgios	CYP 🏆
2.	CHRISTODOULIDES Petros	CYP 🥈
3.	KALAITSIDIS Georgios	CYP 🥉

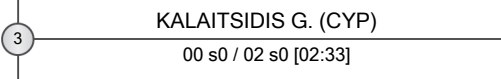



# European Judo Championships of the Small States 2024 Seniors

Cyprus, Nicosia, 2 Nov 2024

## -73 kg

Men (12)

POOL A

	DIMITRIADI Christos	CYP
	BRISOUX Joffrey	LUX
	JORDANOVSKI Gorjan	MLT

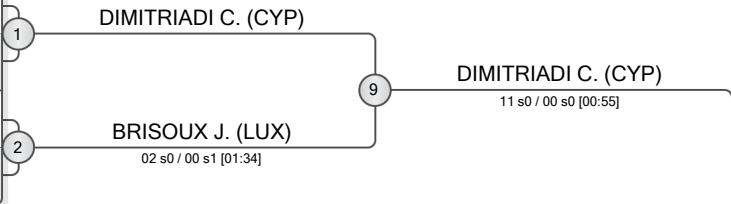

POOL B

	FREI Tristan	LIE
	PSENICNIJS Romans	ISL
	LAZARIDES Stefanos	CYP

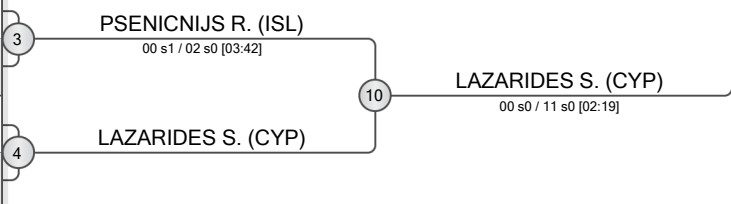

POOL C

	KURAUli Iakovos	CYP
	REIG ARNAU Marc	AND
	ALFONSO Dario	LIE

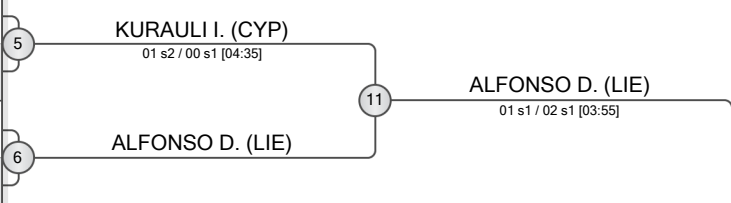

POOL D

	NUNES DOS SANTOS Kevin	LUX
	BICKER Manuel	LIE
	CHARALAMPOUS Vladimiros	CYP

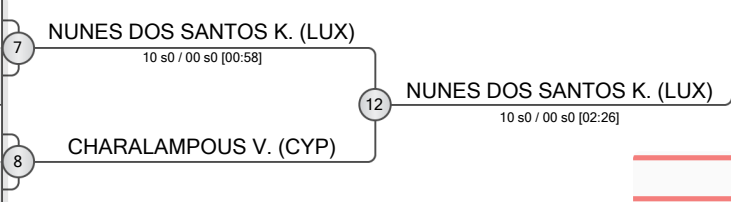

FINAL RESULTS		
1.	DIMITRIADI Christos	CYP
2.	NUNES DOS SANTOS Kevin	LUX
3.	ALFONSO Dario	LIE
3.	LAZARIDES Stefanos	CYP
5.	BRISOUX Joffrey	LUX
5.	KURAUli Iakovos	CYP
7.	PSENICNIJS Romans	ISL
7.	CHARALAMPOUS Vladimiros	CYP

REPECHAGE

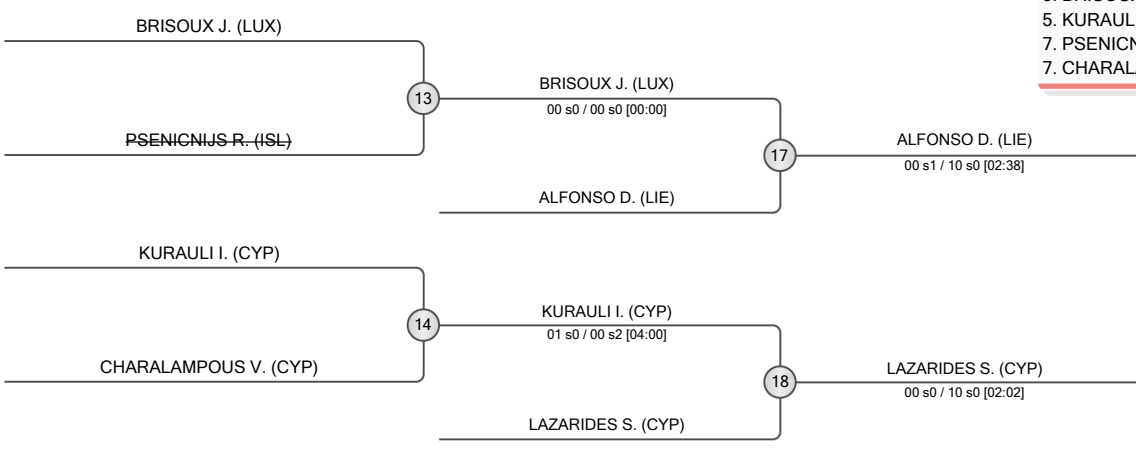



POOL A

GEORGAKIS Odysseas CYP  
 BOGARI MASSINA Ciro SMR

1 GEORGAKIS O. (CYP)

01 s0 / 00 s1 [04:00]

POOL B

SHAKOS Panagiotis CYP  
 NUNES DOS SANTOS Claudio LUX

2 NUNES DOS SANTOS C. (LUX)

00 s2 / 10 s0 [02:35]

POOL C

KESOV Petros CYP  
 BAYANAA Bilgee LUX

3 BAYANAA B. (LUX)

00 s0 / 11 s2 [03:52]

POOL D

TOMAS Joaquim AND  
 CHARALAMPOUS Miltiadis CYP

4 CHARALAMPOUS M. (CYP)

01 s0 / 02 s1 [01:04]

REPECHAGE

BOGARI MASSINA C. (SMR)  
 SHAKOS P. (CYP)

5 SHAKOS P. (CYP)

00 s2 / 01 s0 [04:00]

KESOV P. (CYP)  
 TOMAS J. (AND)

6 TOMAS J. (AND)

00 s0 / 10 s0 [00:00]

CHARALAMPOUS M. (CYP)

10 GEORGAKIS O. (CYP)

02 s0 / 00 s0 [00:44]

7 NUNES DOS SANTOS C. (LUX)

00 s2 / 11 s2 [03:42]

8 BAYANAA B. (LUX)

10 s0 / 00 s0 [02:07]

11 NUNES DOS SANTOS C. (LUX)

10 s0 / 00 s0 [03:17]

FINAL RESULTS		
1.	NUNES DOS SANTOS Claudio	LUX
2.	BAYANAA Bilgee	LUX
3.	SHAKOS Panagiotis	CYP
3.	GEORGAKIS Odysseas	CYP
5.	CHARALAMPOUS Miltiadis	CYP
5.	TOMAS Joaquim	AND

POOL A

MICHAEL Aristos CYP

MICHAEL A. (CYP)

POOL B

KARATSAOUSIDIS Theocharis CYP  
 FIGUEIREDO Figue AND

KARATSAOUSIDIS T. (CYP)  
 10 s0 / 00 s1 [01:20]

POOL C

RAICEVIC Novo MNE

RAICEVIC N. (MNE)

POOL D

WELTER Micha LUX  
 PATSIANTOS Antonios CYP

WELTER M. (LUX)  
 10 s0 / 00 s0 [02:07]

REPECHAGE

FIGUEIREDO F. (AND)

FIGUEIREDO F. (AND)

PATSIANTOS A. (CYP)

PATSIANTOS A. (CYP)

WELTER M. (LUX)  
 00 s0 / 02 s0 [00:36]

KARATSAOUSIDIS T. (CYP)  
 00 s0 / 02 s0 [00:36]

RAICEVIC N. (MNE)  
 00 s0 / 02 s0 [02:20]

FINAL RESULTS		
1.	RAICEVIC Novo	MNE
2.	MICHAEL Aristos	CYP
3.	WELTER Micha	LUX
3.	KARATSAOUSIDIS Theocharis	CYP
5.	FIGUEIREDO Figue	AND
5.	PATSIANTOS Antonios	CYP

Num.	Competitor	State	1	2	3	Wins	Points
1.	NIKOLAOU Kyriakos	Cyprus		10	10	2	20
2.	PATINIOTIS Alexandos	Cyprus	0		10	1	10
3.	JOHANNESSEN Petur Sigurd	Faroe Islands	0	0		0	0

NIKOLAOU Kyriakos	CYP	1	NIKOLAOU K. (CYP)
PATINIOTIS Alexandos	CYP		

11 s0 / 00 s0 [01:06]

FINAL RESULTS		
1. PATINIOTIS Alexandos	CYP	
2. NIKOLAOU Kyriakos	CYP	

NIKOLAOU Kyriakos	CYP	2	NIKOLAOU K. (CYP)
JOHANNESSEN Petur Sigurd	FRO		

11 s0 / 00 s0 [00:50]

PATINIOTIS Alexandos	CYP	3	PATINIOTIS A. (CYP)
JOHANNESSEN Petur Sigurd	FRO		

10 s0 / 00 s0 [00:18]

NIKOLAOU Kyriakos	CYP	4	PATINIOTIS A. (CYP)
PATINIOTIS Alexandos	CYP		

00 s0 / 02 s0 [01:38]

Num.	Competitor	State	1	2	3	Wins	Points
1.	DUBRETA Anto	Montenegro		10	10	2	20
2.	LESCANO CAPDEVILA David	Andorra	0		10	1	10
3.	YIAPANIS Andreas	Cyprus	0	0		0	0

DUBRETA Anto	MNE	1	DUBRETA A. (MNE)
LESCANO CAPDEVILA David	AND		

10 s0 / 00 s0 [01:17]

FINAL RESULTS		
1. DUBRETA Anto	MNE	
2. LESCANO CAPDEVILA David	AND	

DUBRETA Anto	MNE	2	DUBRETA A. (MNE)
YIAPANIS Andreas	CYP		

11 s0 / 00 s0 [01:06]

LESCANO CAPDEVILA David	AND	3	LESCANO CAPDEVILA D. (AND)
YIAPANIS Andreas	CYP		

10 s0 / 00 s0 [00:27]

DUBRETA Anto	MNE	4	DUBRETA A. (MNE)
LESCANO CAPDEVILA David	AND		

10 s0 / 00 s0 [01:05]

POOL A  
POOL B

	ESPOSITO Katryna	MLT
	STYLIANOU Xanthia	CYP

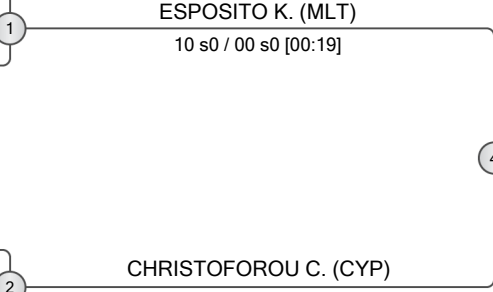

POOL C  
POOL D

	CHRISTOFOROU Christina	CYP
	ALEXANDROU Eirini	CYP

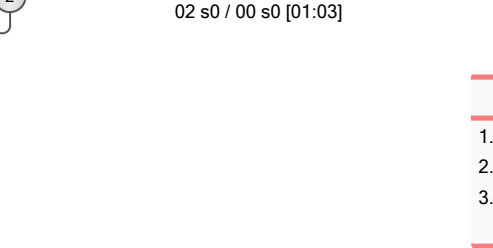

REPECHAGE

STYLIANOU X. (CYP)
ALEXANDROU E. (CYP)

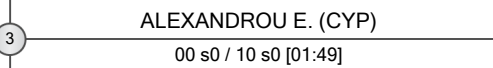

FINAL RESULTS		
1.	ESPOSITO Katryna	MLT
2.	CHRISTOFOROU Christina	CYP
3.	ALEXANDROU Eirini	CYP

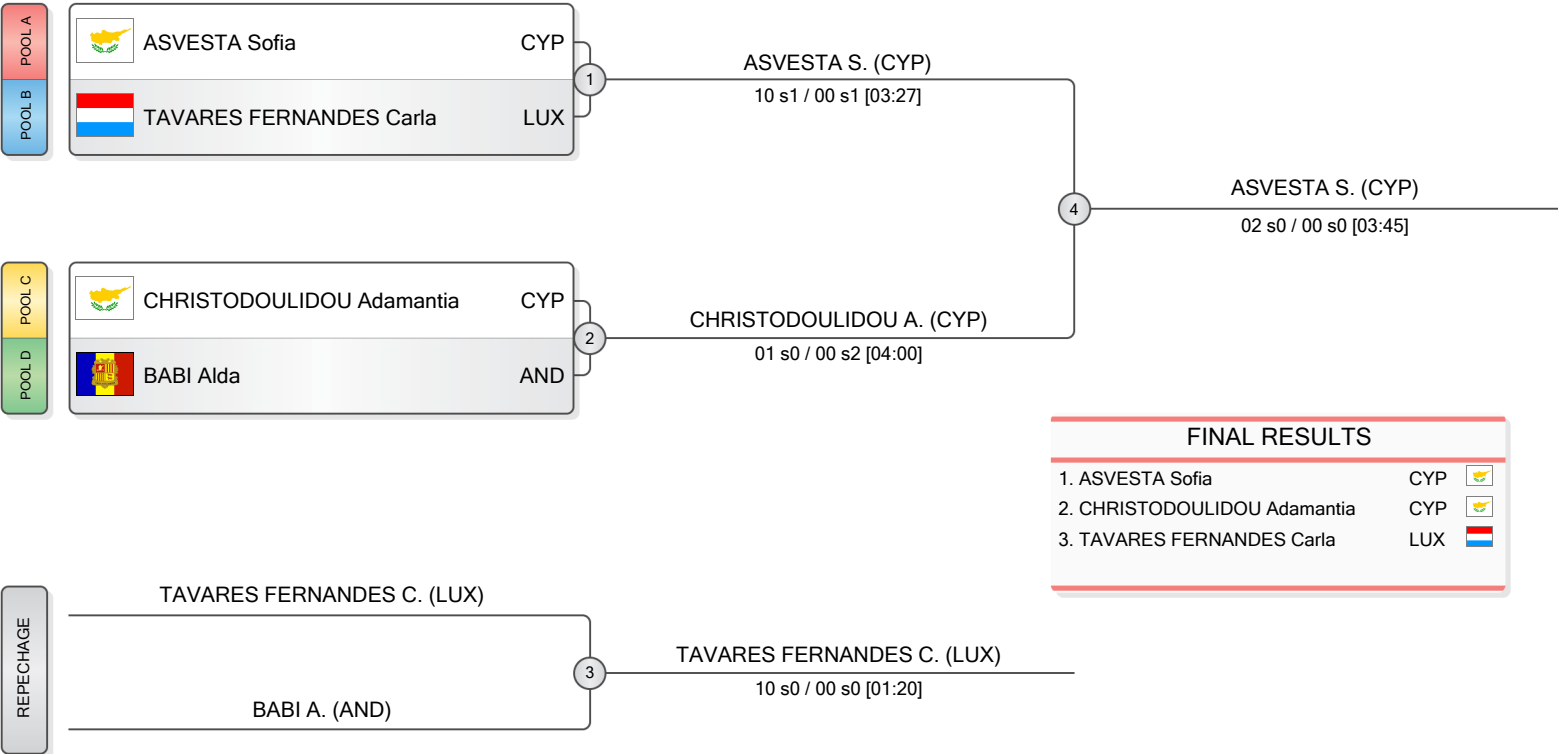

Num.	Competitor	State	1	2	3	Wins	Points
1.	KALAITSIDOU Veronika	Cyprus		0	0	0	0
2.	AZINOI Marina	Cyprus	10		0	1	10
3.	WYSS Lea	Liechtenstein	10	10		2	20

KALAITSIDOU Veronika	CYP	1	AZINOI M. (CYP)
AZINOI Marina	CYP		00 s1 / 10 s0 [00:34]

FINAL RESULTS	
1. AZINOI Marina	CYP
2. WYSS Lea	LIE

KALAITSIDOU Veronika	CYP	2	WYSS L. (LIE)
WYSS Lea	LIE		00 s0 / 02 s0 [00:25]

AZINOI Marina	CYP	3	WYSS L. (LIE)
WYSS Lea	LIE		00 s0 / 10 s0 [00:43]

WYSS Lea	LIE	4	AZINOI M. (CYP)
AZINOI Marina	CYP		00 s3 / 10 s0 [05:00]



Num.	Competitor	State	1	3	5	Wins	Points
1.	MOSR Anetta	Luxembourg		10	10	2	20
3.	VASILIOU Sofia	Cyprus	0		0	0	0
5.	SCHROLLER Lora	Luxembourg	0	10		1	10

Num.	Competitor	State	2	4	Wins	Points
2.	DEMOSTHENOUS Sofia	Cyprus		10	1	10
4.	BJARNADOTTIR Helena	Iceland	0		1	10

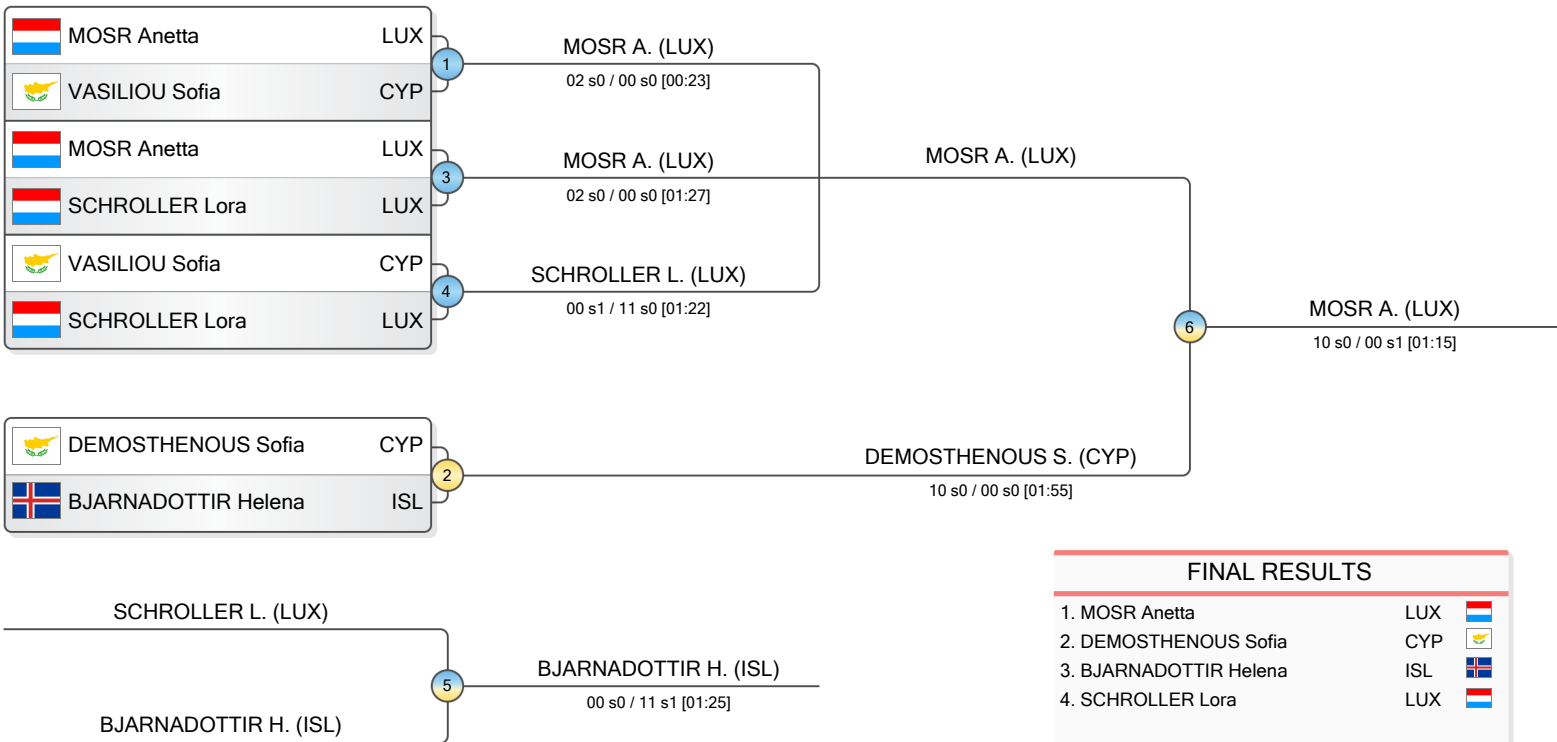

FINAL RESULTS		
1.	MOSR Anetta	LUX
2.	DEMOSTHENOUS Sofia	CYP
3.	BJARNADOTTIR Helena	ISL
4.	SCHROLLER Lora	LUX





Num.	Competitor	State	1	2	3	Wins	Points
1.	MICHAIL Maria	Cyprus		0	0	0	0
2.	DIMITRIOU Diana	Cyprus	0		10	2	10
3.	DONFACK Darlene	Luxembourg	0	0		1	0

MICHAIL Maria	CYP
DIMITRIOU Diana	CYP

1

DIMITRIOU D. (CYP)

00 s0 / 00 s0 [00:00]

FINAL RESULTS		
1. DIMITRIOU Diana	CYP	
2. DONFACK Darlene	LUX	

MICHAIL Maria	CYP
DONFACK Darlene	LUX

2

DONFACK D. (LUX)

00 s0 / 00 s0 [00:00]

DIMITRIOU Diana	CYP
DONFACK Darlene	LUX

3

DIMITRIOU D. (CYP)

02 s0 / 00 s0 [00:57]

DIMITRIOU Diana	CYP
DONFACK Darlene	LUX

4

DIMITRIOU D. (CYP)

10 s0 / 00 s0 [01:47]



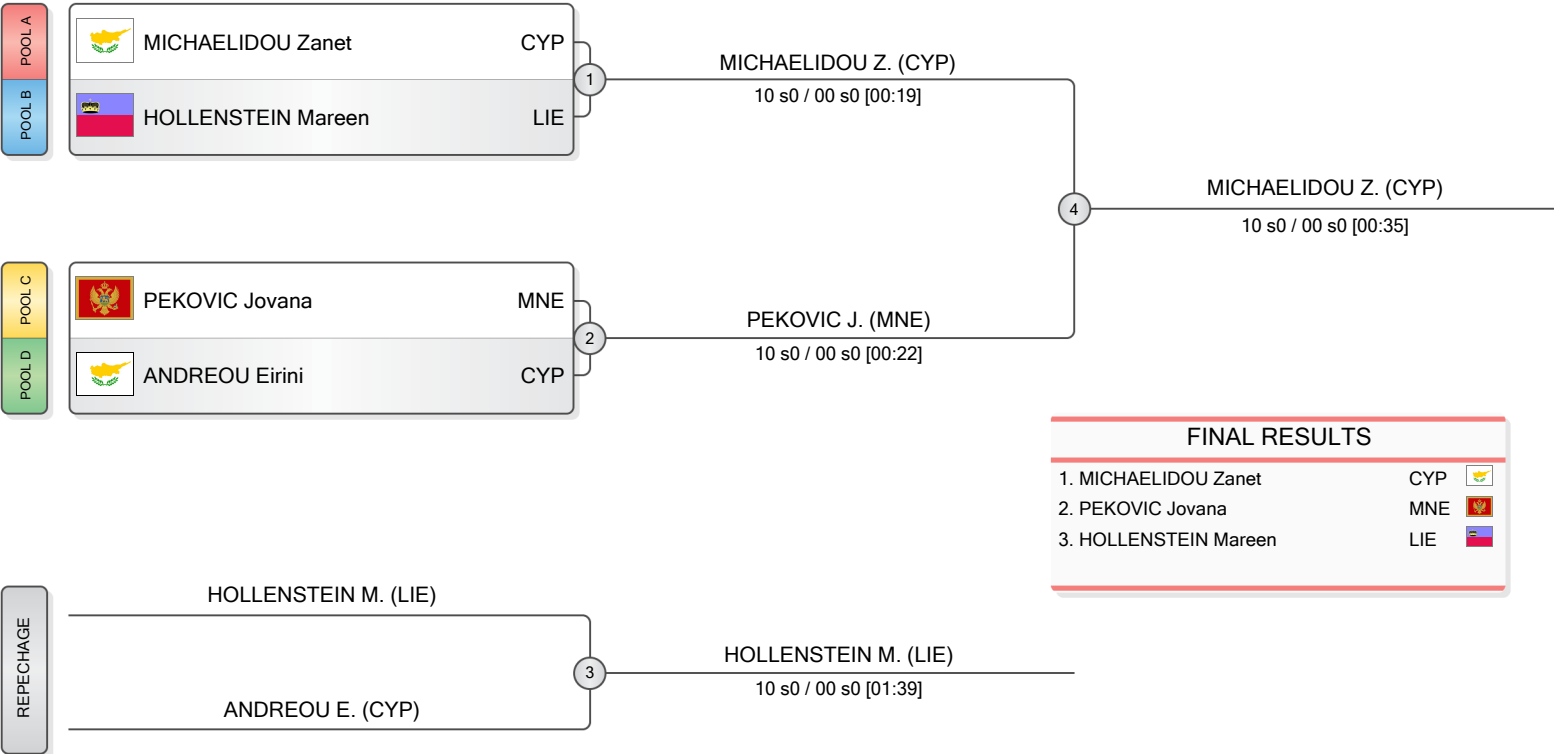

Num.	Competitor	State	1	2	3	Wins	Points
1.	NEOKLEOUS Georgia	Cyprus		0	0	0	0
2.	MRVALJEVIC Jovana	Montenegro	10		10	2	20
3.	KAISER Anja	Liechtenstein	10	1		1	11

NEOKLEOUS Georgia	CYP	1	MRVALJEVIC J. (MNE)
MRVALJEVIC Jovana	MNE		

00 s1 / 02 s0 [00:53]

FINAL RESULTS		
1.	MRVALJEVIC Jovana	MNE
2.	KAISER Anja	LIE

NEOKLEOUS Georgia	CYP	2	KAISER A. (LIE)
KAISER Anja	LIE		

00 s0 / 10 s0 [00:15]

MRVALJEVIC Jovana	MNE	3	MRVALJEVIC J. (MNE)
KAISER Anja	LIE		

02 s0 / 01 s0 [02:09]

MRVALJEVIC Jovana	MNE	4	MRVALJEVIC J. (MNE)
KAISER Anja	LIE		

01 s2 / 00 s1 [04:00]