

220 competitors from 25 nations

137 Men

83 Women











| -60 kg | -66 kg | -73 kg | -81 kg | -90 kg | -100 kg | +100 kg | Men |
|--------|--------|--------|--------|--------|---------|---------|-----|
| 14 | 20 | 33 | 18 | 22 | 14 | 16 | 137 |

| -48 kg | -52 kg | -57 kg | -63 kg | -70 kg | -78 kg | +78 kg | Women |
|--------|--------|--------|--------|--------|--------|--------|-------|
| 2 | 16 | 15 | 19 | 13 | 10 | 8 | 83 |

| Continent | AJU | JUA | EJU | OJU | PJC | Total |
|-------------|-----|-----|-----|-----|-----|-------|
| Nations | 1 | | 22 | 1 | 1 | 25 |
| Competitors | 1 | | 216 | 1 | 2 | 220 |









| Schedule | | |
|----------|-------|-------|
| Date | 6 Jul | 7 Jul |
| Start | 09:30 | 09:30 |
| Finals | 15:45 | 14:30 |









| -60 kg | | |
|--------|----------------------|---|
| 1 | WELING Bart | NED  |
| 2 | HEYDER Maximilian | GER  |
| 3 | NAERT Olivier | BEL  |
| 3 | AMARASEKARA Egilsten | NOR  |
| 5 | WONG Jason | NED  |
| 5 | PIECZYNSKI Hubert | POL  |
| 7 | TUPYTSKYI Denys | UKR  |
| 7 | BLASZCZAK Igor | POL  |









| -66 kg | | |
|--------|------------------------|---|
| 1 | BOUDA Romaric Wend-Yam | FRA  |
| 2 | NURKOVIC Jusuf | MNE  |
| 3 | CHERNOV Vadym | UKR  |
| 3 | FRYER Michael | GBR  |
| 5 | ALLAN Finlay | GBR  |
| 5 | BALARJISHVILI Georgios | CYP  |
| 7 | CARGNELUTTI Francesco | ITA  |
| 7 | YOUNG Charlie | GBR  |

| -73 kg | | |
|--------|--------------------|---|
| 1 | RUEBO Jano | GER  |
| 2 | KARIMOV Chusniddin | CZE  |
| 3 | BATCHAEV Zelemkhan | BEL  |
| 3 | NEBOTOV Serhii | UKR  |
| 5 | THIJSSSEN Niels | NED  |
| 5 | SLAMBERGER Lennart | GER  |
| 7 | TRILLJARV Matheas | EST  |
| 7 | DIKAJEV Saad | EST  |

| -81 kg | | |
|--------|----------------------|---|
| 1 | STARK Vladimir | GER  |
| 2 | TARKOWSKI Fabrycjusz | POL  |
| 3 | MLADY Petr | CZE  |
| 3 | VAN DUN Mo | NED  |
| 5 | PAASTEL Randel | EST  |
| 5 | HEG Koen | NED  |
| 7 | SNIJDERS Thomas | NED  |
| 7 | KOLOBOV Vladyslav | UKR  |







| -90 kg | | |
|--------|-------------------|---|
| 1 | LENZ Johann | GER  |
| 2 | VAN DIJK Mark | NED  |
| 3 | KRYZHANSKYI Marat | UKR  |
| 3 | RENES Tigo | NED  |
| 5 | SCHRIEVER Lasse | GER  |
| 5 | KANSY Fabian | GER  |
| 7 | SLYTERIS Augustas | LTU  |
| 7 | NETIAHA Luka | UKR  |









| -100 kg | | |
|---------|-------------------|---|
| 1 | SCHMIDT Tim | GER  |
| 2 | BULTHUIS Silvan | NED  |
| 3 | CARLETTI Jean | ITA  |
| 3 | BERGAMELLI Enrico | ITA  |
| 5 | DUINOVS Maksims | LAT  |
| 5 | SCHELL Joes | NED  |
| 7 | HUTSOL Danylo | UKR  |
| 7 | BARRATT Oliver | GBR  |









| +100 kg | | |
|---------|--------------------|---|
| 1 | SCHREIBER Jonas | GER  |
| 2 | PRIILINN TURK Karl | EST  |
| 3 | BRONIEC Patryk | POL  |
| 3 | HRYBYK Mykola | UKR  |
| 5 | PLOEHNERT Paavo | GER  |
| 5 | ANTONIOU Giannis | CYP  |
| 7 | GREENIDGE Wesley | GBR  |
| 7 | BLOM Jules | NED  |









| -48 kg | | |
|--------|----------------|---|
| 1 | URDIALES Manon | FRA  |
| | | |
| | | |
| | | |
| | | |
| | | |
| | | |







| -52 kg | | |
|--------|--------------------|---|
| 1 | CASTAGNOLA Martina | ITA  |
| 2 | WURFEL Annika | GER  |
| 3 | CIESLIK Klaudia | POL  |
| 3 | BARBER Caitlin | GBR  |
| 5 | BORODINA Anna | UKR  |
| 5 | CHEVALIER Mathilde | FRA  |
| 7 | SERRA Chiara | GER  |
| 7 | RIBOULON Cloe | FRA  |

| -57 kg | | |
|--------|-----------------------|---|
| 1 | ZIEGLER Jana | GER  |
| 2 | CORNELISSE Pleuni | NED  |
| 3 | LOXHA Flaka | KOS  |
| 3 | LAIHO Venla | FIN  |
| 5 | JANSSEN Danique | NED  |
| 5 | CHYZHEVSKA Anastasiia | UKR  |
| 7 | RASPE Vera | NED  |
| 7 | VERFAILLIE Luna | BEL  |

| -63 kg | | |
|--------|------------------------|---|
| 1 | NALBAT Kamile | NED  |
| 2 | SEDLMAIR Hanna | GER  |
| 3 | AVANZATO Carlotta | ITA  |
| 3 | FOLGER Viktoria | GER  |
| 5 | SAINT ETIENNE Perrine | FRA  |
| 5 | VON LEUPOLDT Charlotte | GER  |
| 7 | DAAMEN Maartje | NED  |
| 7 | ANTIPINA Anastasiia | UKR  |

| -70 kg | | |
|--------|---------------------|---|
| 1 | BUTKEREIT Miriam | GER  |
| 2 | MURPHY Bertille | GER  |
| 3 | MEHLAU Sarah | GER  |
| 3 | BARBAUD Gabrielle | FRA  |
| 5 | FRANZOSI Ludovica | ITA  |
| 5 | VAN WONDEREN Dagmar | NED  |
| 7 | SCHUTJES Lotte | NED  |
| 7 | HEYNS Maxine | BEL  |

| -78 kg | | |
|--------|--------------------------|---|
| 1 | NIEMEYER Mathilda Sophie | GER  |
| 2 | HOELTERHOFF Julie | GER  |
| 3 | SCHMID Lea | GER  |
| 3 | BUDDENKOTTE Eva Ronja | GER  |
| 5 | DZIOPA Paulina | POL  |
| 5 | DUDENAITE Migle Julija | LTU  |
| 7 | CALEO Irene | ITA  |
| 7 | LUDEMA Berber | NED  |

| +78 kg | | |
|--------|------------------|---|
| 1 | AKTAS Emma-Melis | EST  |
| 2 | BULAVINA Ruslana | UKR  |
| 3 | SIMONETTI Erica | ITA  |
| 3 | SWEERS Paulien | NED  |
| 5 | ANDREWS Sydnee | NZL  |
| 5 | LIS Wiktorja | POL  |
| | | |
| | | |

| # | Nation | 1. Place | 2. Place | 3. Place | 5. Place | 7. Place |
|-----|-------------------|----------|----------|----------|----------|----------|
| 1. | GER Germany | 8 | 5 | 4 | 5 | 1 |
| 2. | NED Netherlands | 2 | 3 | 3 | 6 | 6 |
| 3. | FRA France | 2 | | 1 | 2 | 1 |
| 4. | EST Estonia | 1 | 1 | | 1 | 2 |
| 5. | ITA Italy | 1 | | 4 | 1 | 2 |
| 6. | UKR Ukraine | | 1 | 4 | 2 | 5 |
| 7. | POL Poland | | 1 | 2 | 3 | 1 |
| 8. | CZE Czechia | | 1 | 1 | | |
| 9. | MNE Montenegro | | 1 | | | |
| 10. | GBR Great Britain | | | 2 | 1 | 3 |
| 11. | BEL Belgium | | | 2 | | 2 |
| 12. | FIN Finland | | | 1 | | |
| 12. | KOS Kosovo | | | 1 | | |
| 12. | NOR Norway | | | 1 | | |
| 15. | CYP Cyprus | | | | 2 | |
| 16. | LTU Lithuania | | | | 1 | 1 |
| 17. | LAT Latvia | | | | 1 | |
| 17. | NZL New Zealand | | | | 1 | |

Official person:



Statistics

Tallinn European Open 2024, 6-7 Jul 2024

Statistics

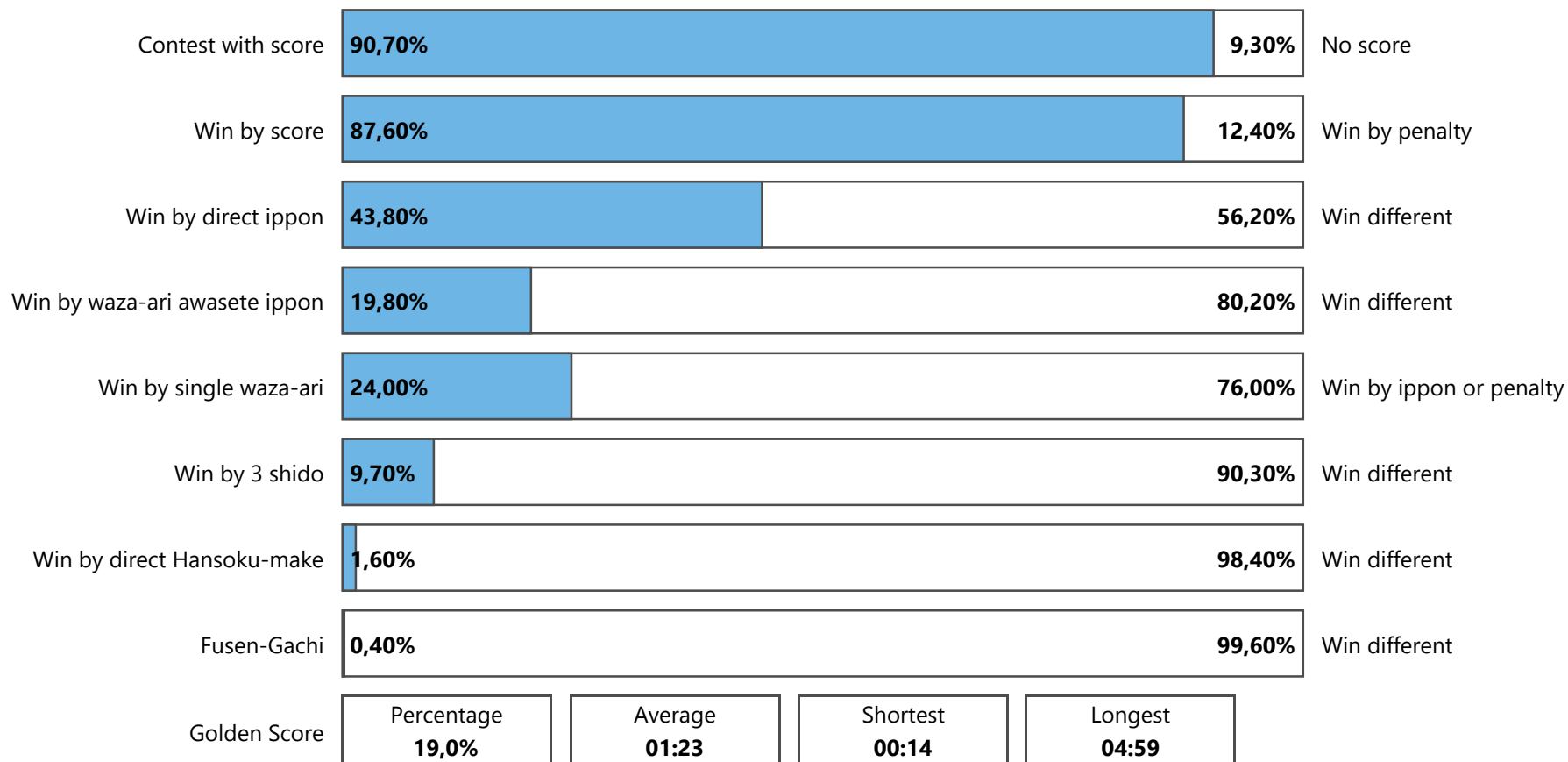



























Statistics

Tallinn European Open 2024, 6-7 Jul 2024

Statistics

| | -60 | -66 | -73 | -81 | -90 | -100 | +100 | M | -48 | -52 | -57 | -63 | -70 | -78 | +78 | W | Total |
|---|-------|-------|-------|-------|------|-------|-------|--------------|------|-------|-------|-------|-------|-------|-------|-------------|--------------|
| Competitors | 14 | 20 | 33 | 18 | 22 | 14 | 16 | 137 | 2 | 16 | 15 | 19 | 13 | 10 | 8 | 83 | 220 |
| Contests | 17 | 23 | 36 | 21 | 25 | 17 | 19 | 158 | 1 | 19 | 18 | 22 | 16 | 13 | 11 | 100 | 258 |
| Contests with score | 14 | 20 | 33 | 19 | 25 | 17 | 16 | 144 | 1 | 18 | 15 | 20 | 13 | 13 | 10 | 90 | 234 |
| Contests with score % | 82,4% | 87% | 91,7% | 90,5% | 100% | 100% | 84,2% | 91,1% | 100% | 94,7% | 83,3% | 90,9% | 81,3% | 100% | 90,9% | 90% | 90,7% |
| Wins by Score | 13 | 19 | 31 | 19 | 23 | 17 | 16 | 138 | 1 | 18 | 14 | 20 | 12 | 13 | 10 | 88 | 226 |
| Wins by Score % | 76,5% | 82,6% | 86,1% | 90,5% | 92% | 100% | 84,2% | 87,3% | 100% | 94,7% | 77,8% | 90,9% | 75% | 100% | 90,9% | 88% | 87,6% |
| Wins by direct Ippon | 5 | 9 | 13 | 9 | 14 | 7 | 9 | 66 | | 11 | 10 | 13 | 5 | 5 | 3 | 47 | 113 |
| Wins by direct Ippon % | 29,4% | 39,1% | 36,1% | 42,9% | 56% | 41,2% | 47,4% | 41,8% | 0% | 57,9% | 55,6% | 59,1% | 31,3% | 38,5% | 27,3% | 47% | 43,8% |
| Wins by Waza-ari Awasete Ippon | 4 | 3 | 6 | 2 | 7 | 6 | 3 | 31 | | 2 | 3 | 5 | 4 | 3 | 3 | 20 | 51 |
| Wins by Waza-ari Awasete Ippon % | 23,5% | 13% | 16,7% | 9,5% | 28% | 35,3% | 15,8% | 19,6% | 0% | 10,5% | 16,7% | 22,7% | 25% | 23,1% | 27,3% | 20% | 19,8% |
| Wins by single Waza-ari | 4 | 7 | 12 | 8 | 2 | 4 | 4 | 41 | 1 | 5 | 1 | 2 | 3 | 5 | 4 | 21 | 62 |
| Wins by single Waza-ari % | 23,5% | 30,4% | 33,3% | 38,1% | 8% | 23,5% | 21,1% | 25,9% | 100% | 26,3% | 5,6% | 9,1% | 18,8% | 38,5% | 36,4% | 21% | 24,0% |
| Wins by 3 Shido for opponent | 2 | 4 | 4 | | 2 | | 2 | 14 | | 1 | 4 | 1 | 4 | | 1 | 11 | 25 |
| Wins by 3 Shido for opponent % | 11,8% | 17,4% | 11,1% | 0% | 8% | 0% | 10,5% | 8,9% | 0% | 5,3% | 22,2% | 4,5% | 25% | 0% | 9,1% | 11% | 9,7% |
| Direct Hansoku-make | 1 | | 1 | 1 | | | | 3 | | | | 1 | | | | 1 | 4 |
| Wins by direct Hansoku-make % | 5,9% | 0% | 2,8% | 4,8% | 0% | 0% | 0% | 1,9% | 0% | 0% | 0% | 4,5% | 0% | 0% | 0% | 1% | 1,6% |
| Fusen-gachi | | | | 1 | | | | 1 | | | | | | | | | 1 |
| Fusen-gachi % | 0% | 0% | 0% | 4,8% | 0% | 0% | 0% | 0,6% | 0% | 0% | 0% | 0% | 0% | 0% | 0% | 0% | 0,4% |
| All positive Scores (Waza-ari + direct Ippon) | 21 | 26 | 42 | 21 | 41 | 28 | 20 | 199 | 1 | 21 | 19 | 30 | 18 | 16 | 17 | 122 | 321 |
| Average Scores per contests | 1,2 | 1,1 | 1,2 | 1 | 1,6 | 1,6 | 1,1 | 1,26 | 1 | 1,1 | 1,1 | 1,4 | 1,1 | 1,2 | 1,5 | 1,2 | 1,23 |
| All penalties (Shido + HSK) | 21 | 46 | 50 | 32 | 32 | 23 | 33 | 237 | 1 | 23 | 32 | 27 | 28 | 18 | 25 | 154 | 391 |
| Average penalty per contest | 1,2 | 2 | 1,4 | 1,5 | 1,3 | 1,4 | 1,7 | 1,5 | 1 | 1,2 | 1,8 | 1,2 | 1,8 | 1,4 | 2,3 | 1,53 | 1,51 |
| Golden Score | 3 | 8 | 6 | 7 | 3 | 1 | 3 | 31 | 1 | 6 | 3 | 3 | | 2 | 3 | 18 | 49 |
| Golden Score % | 17,6% | 34,8% | 16,7% | 33,3% | 12% | 5,9% | 15,8% | 19,6% | 100% | 31,6% | 16,7% | 13,6% | 0% | 15,4% | 27,3% | 18% | 19,0% |
| Osae-komi | | | | | | | | | | | | | | | | | |
| Osae-komi % | 0% | 0% | 0% | 0% | 0% | 0% | 0% | 0% | 0% | 0% | 0% | 0% | 0% | 0% | 0% | 0% | 0% |
| Wins by Penalty | 3 | 4 | 5 | 1 | 2 | | 2 | 17 | | 1 | 4 | 2 | 4 | | 1 | 12 | 29 |

| | | | -60 | -66 | -73 | -81 | -90 | -100 | +100 | M | -48 | -52 | -57 | -63 | -70 | -78 | +78 | W | Total | D |
|-----|---|-------------------|-----|-----|-----|-----|-----|------|------|-----|-----|-----|-----|-----|-----|-----|-----|----|-------|----|
| 1. |  | AUT Austria | 0 | 0 | 0 | 0 | 1 | 2 | 0 | 3 | 0 | 0 | 0 | 0 | 0 | 0 | 0 | 0 | 3 | 0 |
| 2. |  | BEL Belgium | 1 | 0 | 1 | 0 | 0 | 0 | 1 | 3 | 0 | 0 | 1 | 0 | 1 | 0 | 0 | 2 | 5 | 1 |
| 3. |  | CYP Cyprus | 0 | 2 | 0 | 0 | 0 | 0 | 1 | 3 | 0 | 0 | 0 | 0 | 0 | 0 | 0 | 0 | 3 | 1 |
| 4. |  | CZE Czechia | 0 | 0 | 1 | 1 | 0 | 0 | 0 | 2 | 0 | 0 | 0 | 0 | 0 | 0 | 0 | 0 | 2 | 1 |
| 5. |  | DEN Denmark | 0 | 0 | 0 | 0 | 0 | 0 | 0 | 0 | 0 | 0 | 1 | 0 | 0 | 0 | 0 | 1 | 1 | 0 |
| 6. |  | EST Estonia | 1 | 1 | 4 | 3 | 2 | 2 | 2 | 15 | 0 | 2 | 2 | 1 | 1 | 0 | 1 | 7 | 22 | 9 |
| 7. |  | FIN Finland | 0 | 1 | 2 | 0 | 2 | 0 | 0 | 5 | 0 | 0 | 1 | 1 | 2 | 1 | 0 | 5 | 10 | 2 |
| 8. |  | FRA France | 0 | 2 | 1 | 0 | 0 | 0 | 0 | 3 | 1 | 2 | 0 | 2 | 1 | 0 | 1 | 7 | 10 | 3 |
| 9. |  | GBR Great Britain | 0 | 3 | 1 | 0 | 1 | 1 | 1 | 7 | 0 | 2 | 1 | 1 | 0 | 1 | 0 | 5 | 12 | 3 |
| 10. |  | GER Germany | 2 | 2 | 6 | 1 | 4 | 1 | 3 | 19 | 0 | 2 | 1 | 6 | 3 | 4 | 0 | 16 | 35 | 6 |
| 11. |  | HUN Hungary | 0 | 0 | 0 | 1 | 0 | 0 | 0 | 1 | 0 | 0 | 0 | 0 | 0 | 0 | 0 | 0 | 1 | 0 |
| 12. |  | ITA Italy | 1 | 2 | 2 | 0 | 1 | 2 | 0 | 8 | 1 | 2 | 1 | 1 | 1 | 1 | 1 | 8 | 16 | 3 |
| 13. |  | KOS Kosovo | 0 | 0 | 1 | 0 | 0 | 0 | 0 | 1 | 0 | 1 | 1 | 0 | 0 | 0 | 0 | 2 | 3 | 1 |
| 14. |  | LAT Latvia | 1 | 0 | 2 | 2 | 1 | 1 | 1 | 8 | 0 | 1 | 0 | 0 | 0 | 0 | 0 | 1 | 9 | 3 |
| 15. |  | LTU Lithuania | 0 | 0 | 0 | 0 | 1 | 1 | 0 | 2 | 0 | 0 | 0 | 0 | 0 | 1 | 1 | 2 | 4 | 2 |
| 16. |  | MAR Morocco | 0 | 0 | 1 | 0 | 0 | 0 | 0 | 1 | 0 | 0 | 0 | 0 | 0 | 0 | 0 | 0 | 1 | 1 |
| 17. |  | MEX Mexico | 1 | 0 | 0 | 1 | 0 | 0 | 0 | 2 | 0 | 0 | 0 | 0 | 0 | 0 | 0 | 0 | 2 | 1 |
| 18. |  | MNE Montenegro | 0 | 1 | 1 | 0 | 0 | 0 | 0 | 2 | 0 | 0 | 0 | 0 | 0 | 0 | 0 | 0 | 2 | 0 |
| 19. |  | NED Netherlands | 2 | 1 | 1 | 3 | 4 | 2 | 1 | 14 | 0 | 1 | 3 | 4 | 2 | 1 | 1 | 12 | 26 | 7 |
| 20. |  | NOR Norway | 1 | 1 | 1 | 0 | 1 | 0 | 0 | 4 | 0 | 0 | 0 | 0 | 0 | 0 | 0 | 0 | 4 | 1 |
| 21. |  | NZL New Zealand | 0 | 0 | 0 | 0 | 0 | 0 | 0 | 0 | 0 | 0 | 0 | 0 | 0 | 0 | 1 | 1 | 1 | 0 |
| 22. |  | POL Poland | 2 | 1 | 2 | 2 | 1 | 0 | 1 | 9 | 0 | 1 | 0 | 1 | 0 | 1 | 1 | 4 | 13 | 5 |
| 23. |  | ROU Romania | 0 | 0 | 0 | 0 | 0 | 0 | 0 | 0 | 0 | 0 | 0 | 0 | 1 | 0 | 0 | 1 | 1 | 1 |
| 24. |  | SLO Slovenia | 0 | 0 | 0 | 1 | 0 | 1 | 0 | 2 | 0 | 1 | 1 | 0 | 0 | 0 | 0 | 2 | 4 | 2 |
| 25. |  | UKR Ukraine | 2 | 3 | 6 | 3 | 3 | 1 | 5 | 23 | 0 | 1 | 3 | 1 | 1 | 0 | 1 | 7 | 30 | 4 |
| | | | 14 | 20 | 33 | 18 | 22 | 14 | 16 | 137 | 2 | 16 | 15 | 19 | 13 | 10 | 8 | 83 | 220 | 57 |



Tallinn European Open 2024

Estonia, Tallinn, 6-7 Jul 2024

-60 kg
Men (14)

POOL A

| | | |
|--|-------------------|-----|
| | HEYDER Maximilian | GER |
| | TUPYTSKYI Denys | UKR |
| | SHCHEKOTIN Filipp | EST |

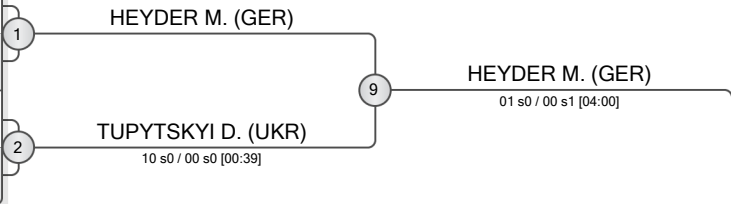

POOL B

| | | |
|--|-----------------------|-----|
| | PIECZYNSKI Hubert | POL |
| | SCHIRALDI Michele | ITA |
| | LATSCHINJAN Hratschik | GER |
| | WONG Jason | NED |

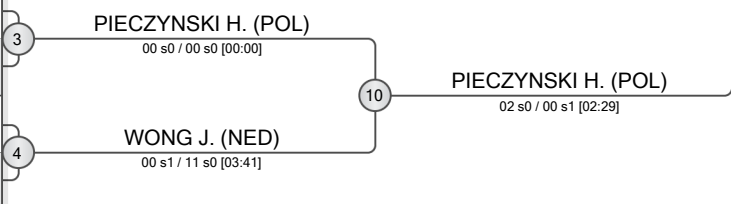

POOL C

| | | |
|--|--------------------|-----|
| | WELING Bart | NED |
| | BLASZCZAK Igor | POL |
| | RAMIREZ Juan Pablo | MEX |

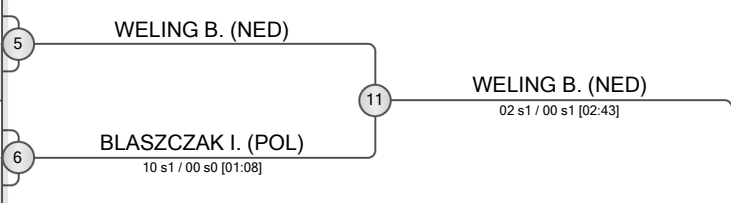

POOL D

| | | |
|--|----------------------|-----|
| | AMARASEKARA Egilsten | NOR |
| | LARKIN Danylo | UKR |
| | NAERT Olivier | BEL |
| | RIZOV S Andrejs | LAT |

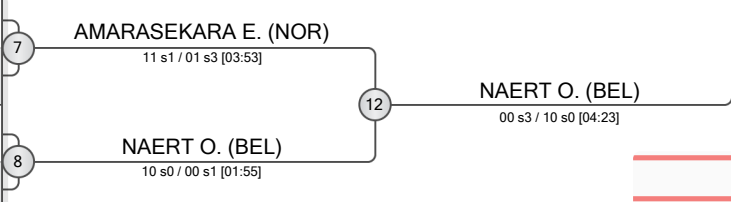

REPECHAGE

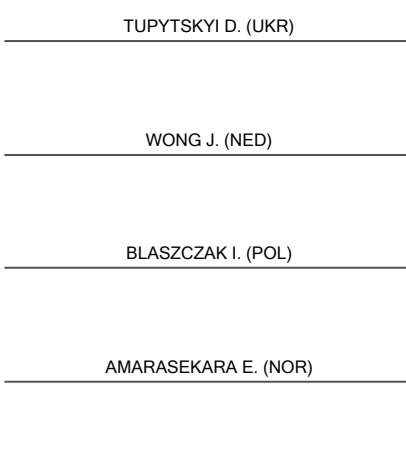

| FINAL RESULTS | | |
|---------------|----------------------|-----|
| 1. | WELING Bart | NED |
| 2. | HEYDER Maximilian | GER |
| 3. | NAERT Olivier | BEL |
| 3. | AMARASEKARA Egilsten | NOR |
| 5. | WONG Jason | NED |
| 5. | PIECZYNSKI Hubert | POL |
| 7. | TUPYTSKYI Denys | UKR |
| 7. | BLASZCZAK Igor | POL |





Tallinn European Open 2024

Estonia, Tallinn, 6-7 Jul 2024

-66 kg

Men (20)

POOL A

| | | |
|--|------------------------|-----|
| | BALARJISHVILI Georgios | CYP |
| | KONT Carl-Gustav | EST |
| | DUMONTIER Pierre | FRA |
| | CARGNELUTTI Francesco | ITA |
| | KURKOID Heorhii | UKR |

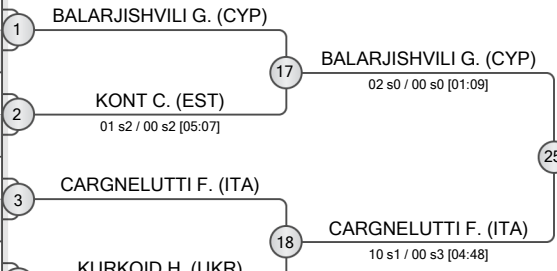

POOL B

| | | |
|--|-----------------|-----|
| | NURKOVIC Jusuf | MNE |
| | WEISSER Patrick | GER |
| | MARANDIAN Karo | UKR |
| | KRIJTHE Nanco | NED |
| | ALLAN Finlay | GBR |

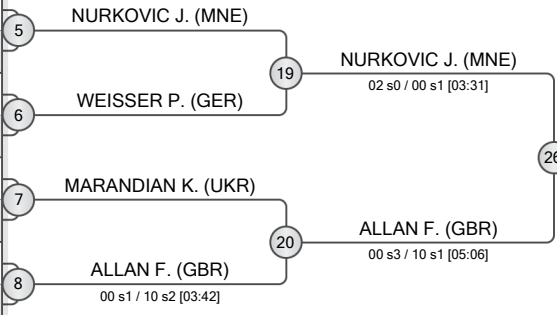

POOL C

| | | |
|--|---------------------|-----|
| | YOUNG Charlie | GBR |
| | KUJANHAARA Joonatan | FIN |
| | DUDORKHANOV Khusein | NOR |
| | CAGGIANO Luca | ITA |
| | CHERNOV Vadym | UKR |

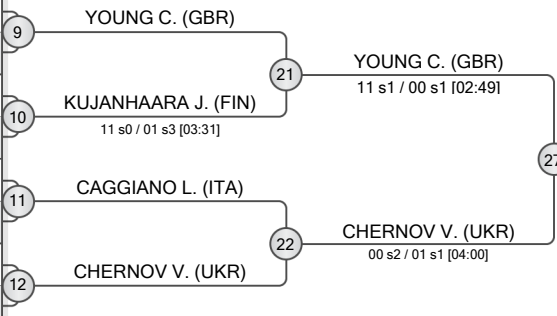

POOL D

| | | |
|--|------------------------|-----|
| | FRYER Michael | GBR |
| | TYLEK Pawel | POL |
| | EDMEIER Severin | GER |
| | BOUDA Romaric Wend-Yam | FRA |
| | CHRISTODOULIDES Petros | CYP |

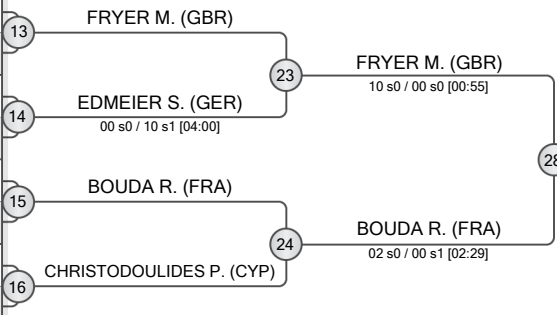

REPECHAGE

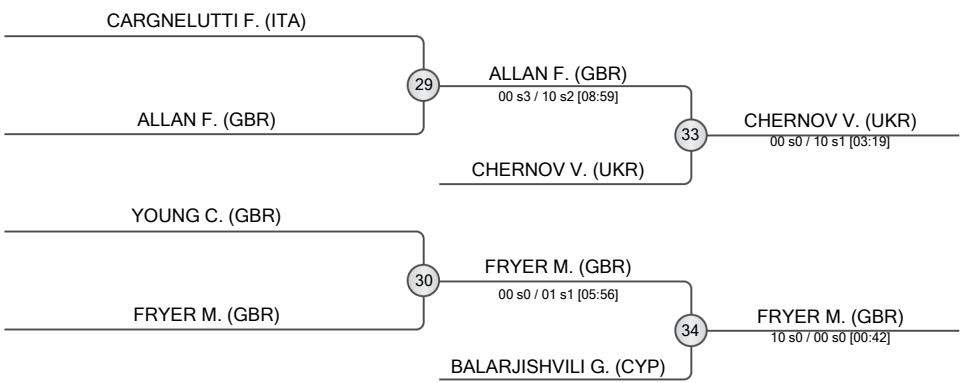

BOUDA R. (FRA) 35

BOUDA R. (FRA) 32

| FINAL RESULTS | | |
|---------------|------------------------|-----|
| 1. | BOUDA Romaric Wend-Yam | FRA |
| 2. | NURKOVIC Jusuf | MNE |
| 3. | CHERNOV Vadym | UKR |
| 3. | FRYER Michael | GBR |
| 5. | ALLAN Finlay | GBR |
| 5. | BALARJISHVILI Georgios | CYP |
| 7. | CARGNELUTTI Francesco | ITA |
| 7. | YOUNG Charlie | GBR |





Tallinn European Open 2024

Estonia, Tallinn, 6-7 Jul 2024

-73 kg
Men (33)

POOL A

| | | |
|--|--------------------|-----|
| | RUEBO Jano | GER |
| | BRUDETTI Luigi | ITA |
| | LIPARD Viljar | EST |
| | ROZHYNOV Mykhailo | UKR |
| | BATCHAEV Zelemkhan | BEL |
| | MEYER Luc | GER |
| | TUTUNAROV Yoan | NOR |
| | DE ANGELIS Anthony | LAT |

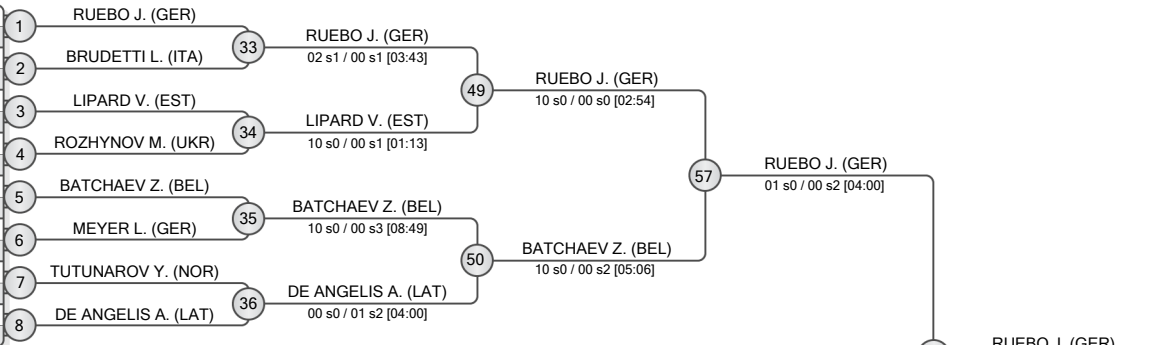

POOL B

| | | |
|--|---------------------|-----|
| | NURKOVIC Jahja | MNE |
| | ROS Artem | UKR |
| | TRILLJARV Matheas | EST |
| | ECABBANE Abdessamad | MAR |
| | MROWCZYNSKI Wiktor | POL |
| | KULIESHOV Nazar | UKR |
| | RONTY Sami | FIN |
| | SLAMBERGER Lennart | GER |

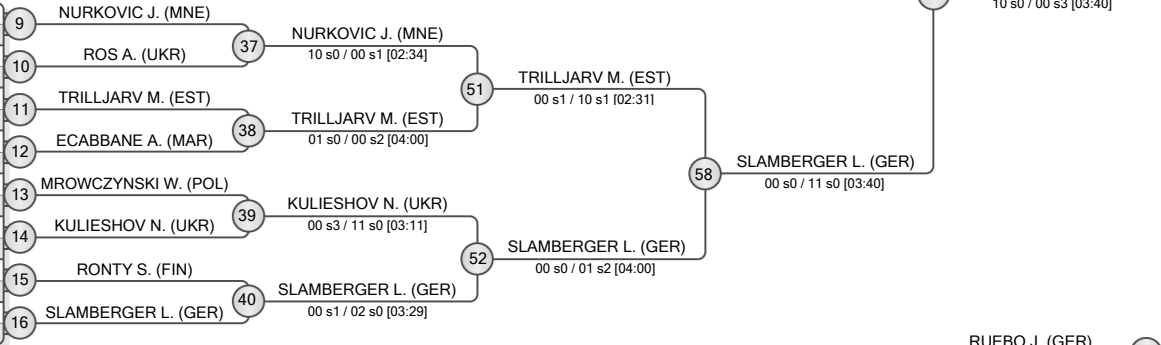

POOL C

| | | |
|--|--------------------|-----|
| | CENA Dardan | KOS |
| | NEBOTOV Serhii | UKR |
| | THOMAS Peter | GER |
| | SHORT Oliver | GBR |
| | KARIMOV Chusniddin | CZE |
| | LUHA Markus | EST |
| | KORHONEN Roope | FIN |
| | JAVORSKIS Roberts | LAT |

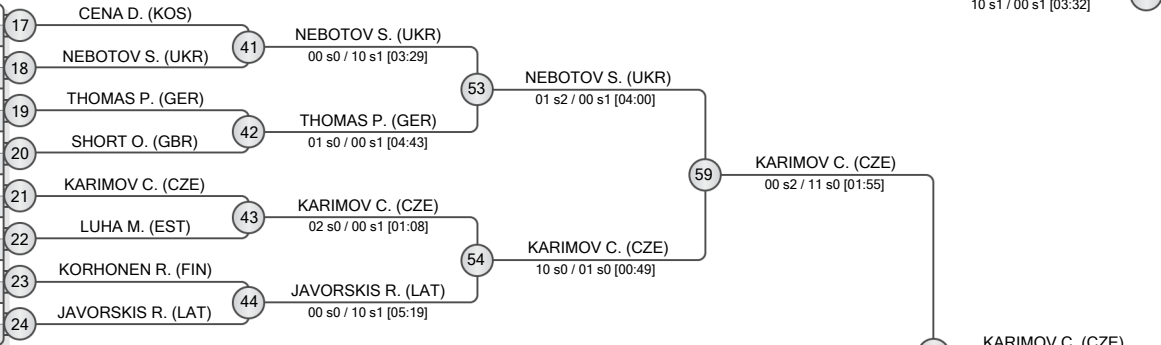

POOL D

| | | |
|--|----------------------|-----|
| | KAZIMIROV Vladyslav | UKR |
| | THIJSSSEN Niels | NED |
| | BIELINSKI Filip | POL |
| | WANDTKE Viktor Marko | GER |
| | SALVO Samuel | ITA |
| | KOSHLIAK Oleksandr | UKR |
| | DIKAJEV Saad | EST |
| | BLANDIN Antonin | FRA |
| | ABELTSHAUSER Kevin | GER |

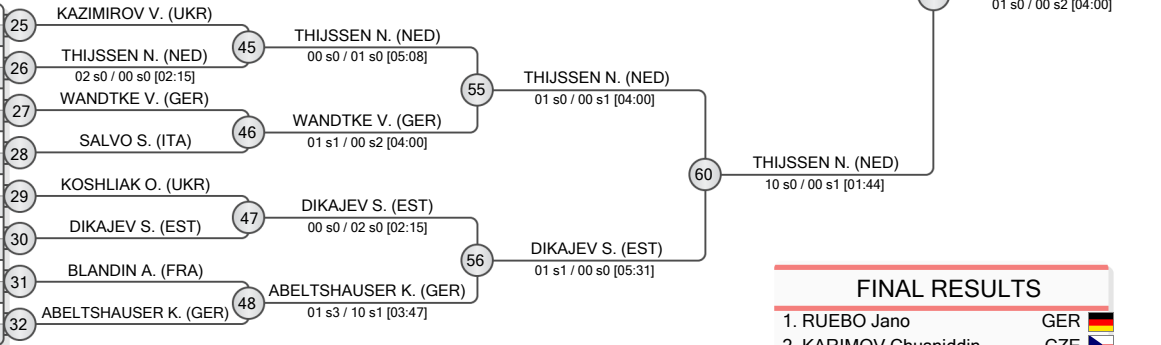

REPECHAGE

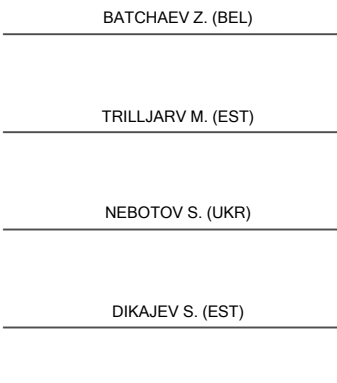

FINAL RESULTS

| | | | |
|----|--------------------|-----|--|
| 1. | RUEBO Jano | GER | |
| 2. | KARIMOV Chusniddin | CZE | |
| 3. | BATCHAEV Zelemkhan | BEL | |
| 3. | NEBOTOV Serhii | UKR | |
| 5. | THIJSSSEN Niels | NED | |
| 5. | SLAMBERGER Lennart | GER | |
| 7. | TRILLJARV Matheas | EST | |
| 7. | DIKAJEV Saad | EST | |





Tallinn European Open 2024

Estonia, Tallinn, 6-7 Jul 2024

-81 kg

Men (18)

POOL A

| | | |
|--|----------------|-----|
| | MLADY Petr | CZE |
| | KHOMULA Artem | UKR |
| | ROGALSKI Oskar | POL |
| | TALTS Rasmus | EST |
| | VAN DUN Mo | NED |

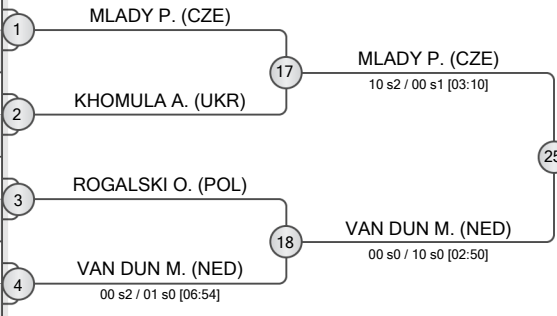

POOL B

| | | |
|--|--------------------|-----|
| | STARK Vladimir | GER |
| | PLOSTNIEKS Ronalds | LAT |
| | SNIJDERS Thomas | NED |
| | RAMIREZ Jose | MEX |

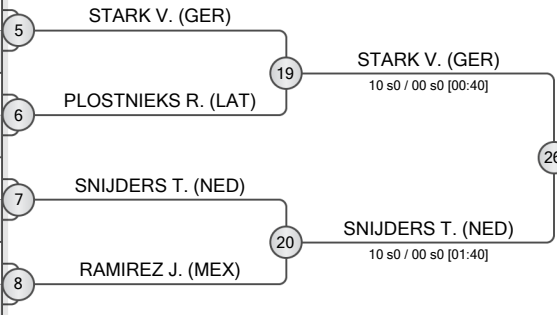

POOL C

| | | |
|--|-------------------|-----|
| | KOLOBOV Vladyslav | UKR |
| | PLANTAK Aljaz | SLO |
| | MIHALOVS Ivans | LAT |
| | PAASTEL Randel | EST |

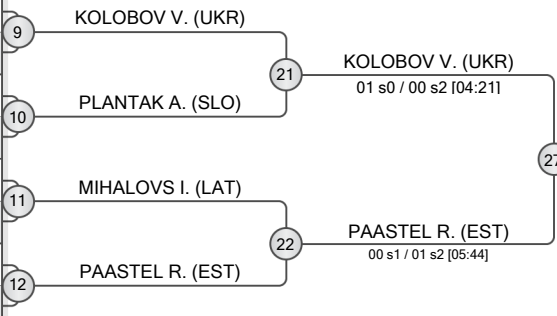

POOL D

| | | |
|--|----------------------|-----|
| | TOTH Botond | HUN |
| | RISTMAE Joonatan | EST |
| | HEG Koen | NED |
| | TARKOWSKI Fabrycjusz | POL |
| | LEONTIEV Vadym | UKR |

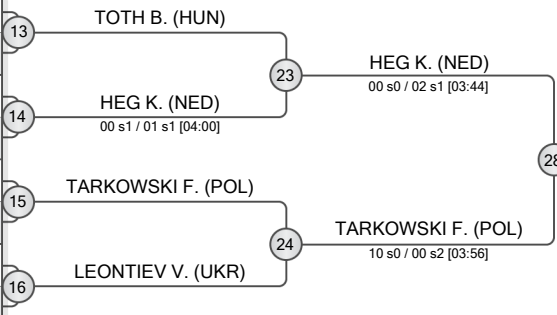

REPECHAGE

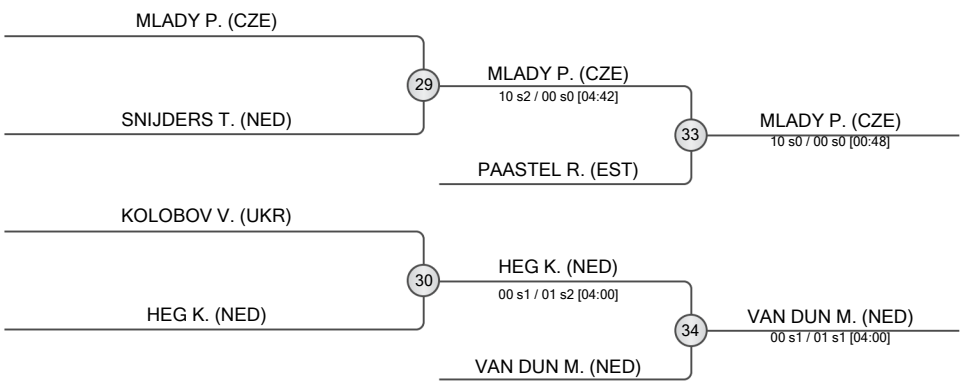

| FINAL RESULTS | |
|-------------------------|--|
| 1. STARK Vladimir | |
| 2. TARKOWSKI Fabrycjusz | |
| 3. MLADY Petr | |
| 3. VAN DUN Mo | |
| 5. PAASTEL Randel | |
| 5. HEG Koen | |
| 7. SNIJDERS Thomas | |
| 7. KOLOBOV Vladyslav | |





Tallinn European Open 2024

Estonia, Tallinn, 6-7 Jul 2024

-90 kg

Men (22)

POOL A

| | | |
|--|-----------------------|-----|
| | VAN DIJK Mark | NED |
| | EILERTSEN Kornelius | NOR |
| | BRETSCHNEIDER Gabriel | AUT |
| | KRYZHANSKYI Marat | UKR |
| | YLIRUUSI Teo | FIN |
| | SEIFERT Markus | GER |

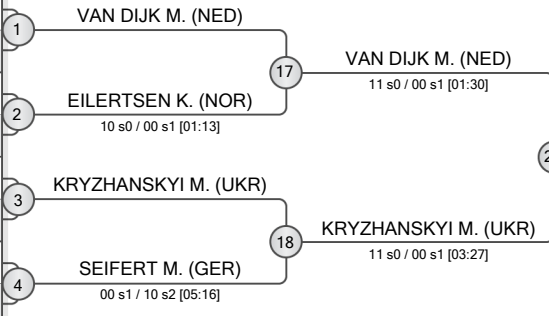

POOL B

| | | |
|--|-------------------|-----|
| | KANSY Fabian | GER |
| | REIMETS Georg | EST |
| | PANKOWSKI Jakub | POL |
| | DE BRUIN Jelle | NED |
| | SLYTERIS Augustas | LTU |

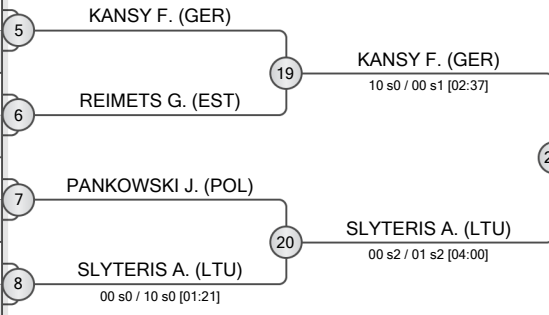

POOL C

| | | |
|--|-----------------------|-----|
| | RENES Tigo | NED |
| | MANFELDS Ralfs Karlis | LAT |
| | KANEVETS Artur | FIN |
| | VALIEIEV Tymur | UKR |
| | SCHRIEVER Lasse | GER |

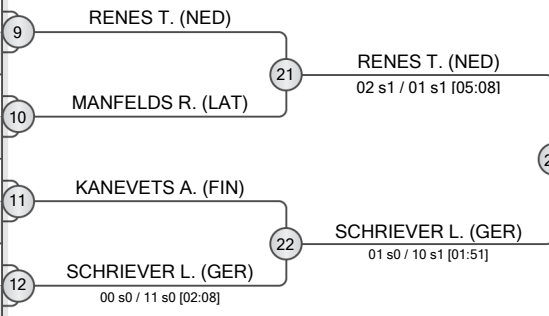

POOL D

| | | |
|--|---------------------|-----|
| | LENZ Johann | GER |
| | GREGORY Max | GBR |
| | SAMMARTINO Gabriele | ITA |
| | VAN HERK Ian | NED |
| | NETIAHA Luka | UKR |
| | HOLTSMEIER Oliver | EST |

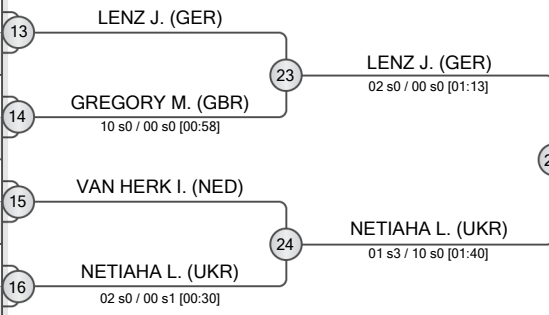

REPECHAGE

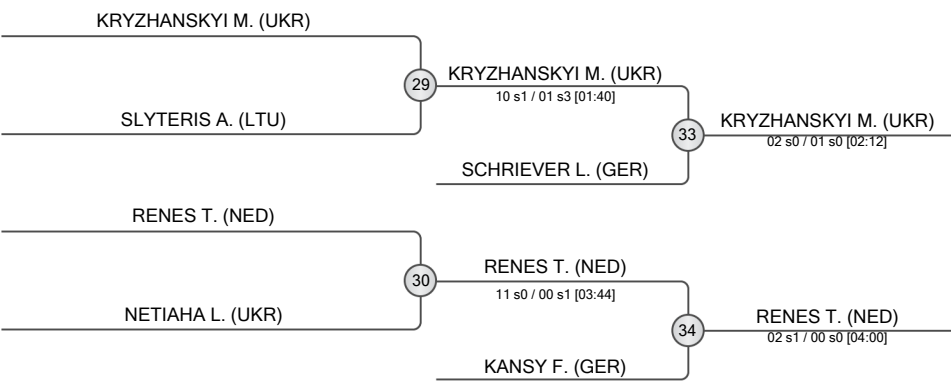

| FINAL RESULTS | |
|---------------|-------------------|
| 1. | LENZ Johann |
| 2. | VAN DIJK Mark |
| 3. | KRYZHANSKYI Marat |
| 3. | RENES Tigo |
| 5. | SCHRIEVER Lasse |
| 5. | KANSY Fabian |
| 7. | SLYTERIS Augustas |
| 7. | NETIAHA Luka |





Tallinn European Open 2024

Estonia, Tallinn, 6-7 Jul 2024

-100 kg
Men (14)

POOL A

| | | |
|--|---------------------|-----|
| | CARLETTI Jean | ITA |
| | BULTHUIS Silvan | NED |
| | KLIMASAUSKAS Mantas | LTU |

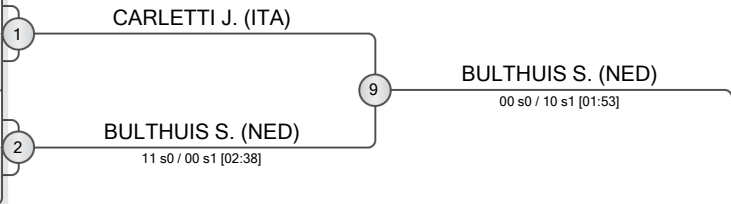

POOL B

| | | |
|--|--------------------|-----|
| | BERGAMELLI Enrico | ITA |
| | BORCHASHVILLI Adam | AUT |
| | HUTSOL Danylo | UKR |
| | OLEV Janari | EST |

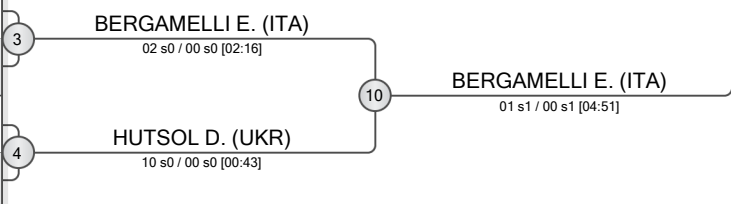

POOL C

| | | |
|--|----------------------|-----|
| | SCHELL Joes | NED |
| | SCHMIDT Tim | GER |
| | NIEDERDORFER Michael | AUT |

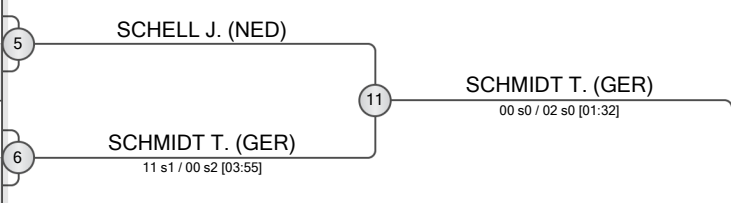

POOL D

| | | |
|--|----------------------|-----|
| | BARRATT Oliver | GBR |
| | VARES Jakob | EST |
| | BERTALANIC ZIZEK Gal | SLO |
| | DUINOVS Maksims | LAT |

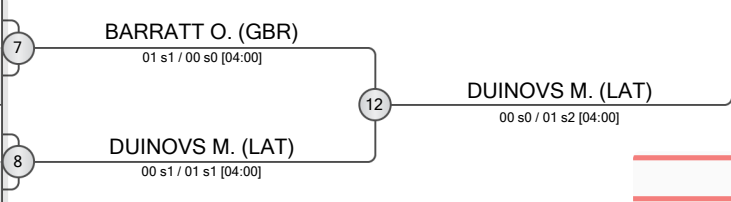

REPECHAGE

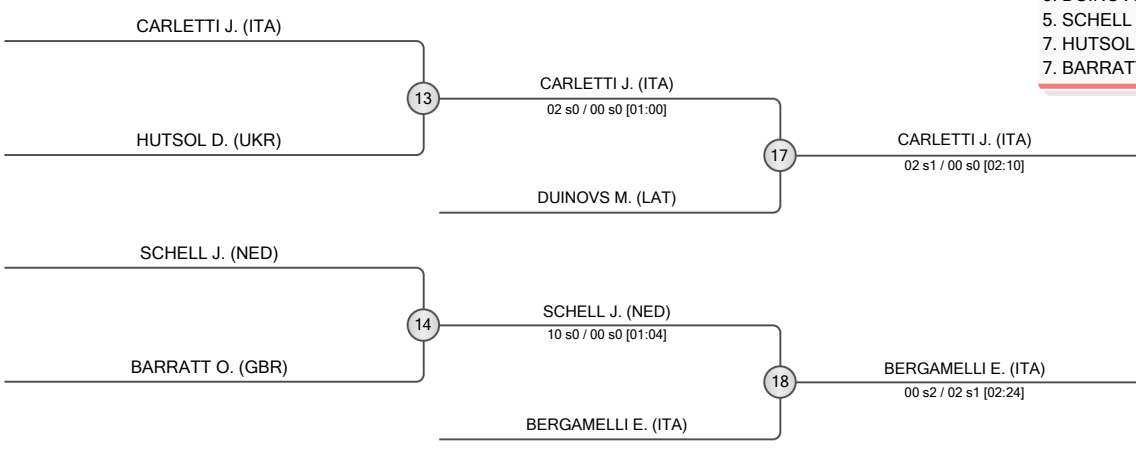

| FINAL RESULTS | | |
|---------------|-------------------|-----|
| 1. | SCHMIDT Tim | GER |
| 2. | BULTHUIS Silvan | NED |
| 3. | CARLETTI Jean | ITA |
| 3. | BERGAMELLI Enrico | ITA |
| 5. | DUINOVS Maksims | LAT |
| 5. | SCHELL Joes | NED |
| 7. | HUTSOL Danylo | UKR |
| 7. | BARRATT Oliver | GBR |





Tallinn European Open 2024

Estonia, Tallinn, 6-7 Jul 2024

+100 kg

Men (16)

POOL A

| | | |
|--|------------------|-----|
| | ANTONIOU Giannis | CYP |
| | DUNIAMALIEV Zaur | UKR |
| | PLOEHNERT Paavo | GER |
| | CAPELLE Edouard | BEL |

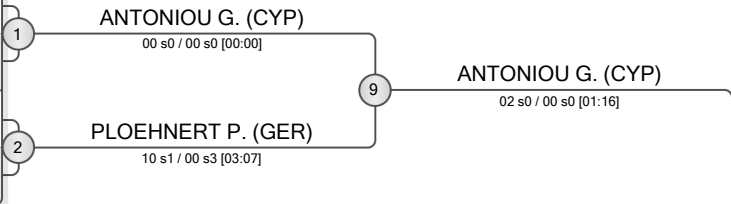

POOL B

| | | |
|--|--------------------|-----|
| | GREENIDGE Wesley | GBR |
| | MOISIEIEV Alieksei | UKR |
| | PRIILINN TURK Karl | EST |
| | LIKANSIS Gustavs | LAT |

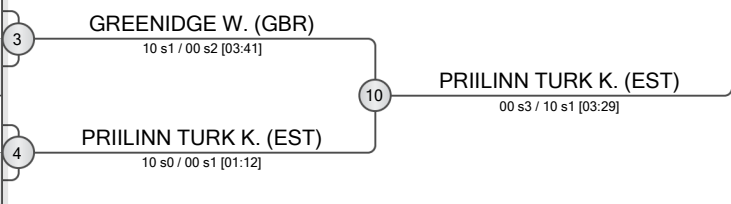

POOL C

| | | |
|--|----------------|-----|
| | KHAMMO Yakiv | UKR |
| | BRONIEC Patryk | POL |
| | BELZ Marvin | GER |
| | HRYBYK Mykola | UKR |

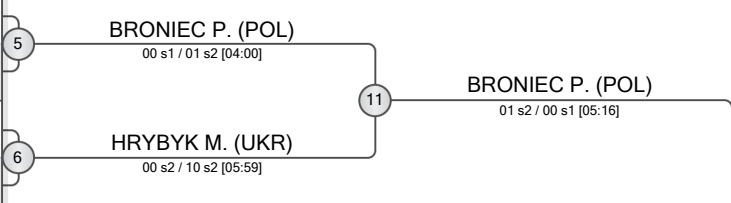

POOL D

| | | |
|--|------------------|-----|
| | SCHREIBER Jonas | GER |
| | MACHUTADZE Nodar | UKR |
| | BLOM Jules | NED |
| | KIRNA Kabriel | EST |

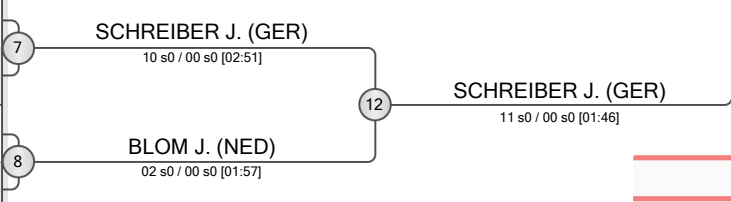

REPECHAGE

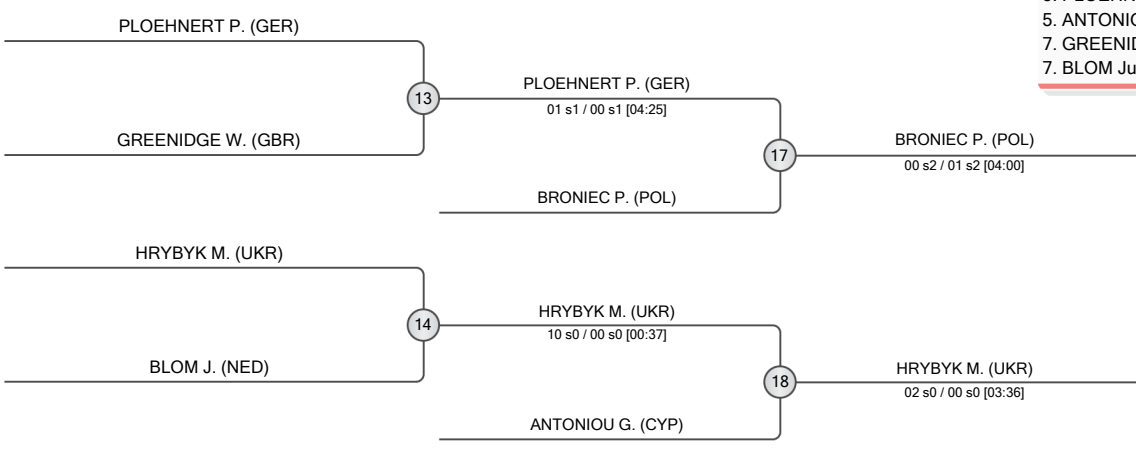

| FINAL RESULTS | | |
|---------------|--------------------|-----|
| 1. | SCHREIBER Jonas | GER |
| 2. | PRIILINN TURK Karl | EST |
| 3. | BRONIEC Patryk | POL |
| 3. | HRYBYK Mykola | UKR |
| 5. | PLOEHNERT Paavo | GER |
| 5. | ANTONIOU Giannis | CYP |
| 7. | GREENIDGE Wesley | GBR |
| 7. | BLOM Jules | NED |





Tallinn European Open 2024

Estonia, Tallinn, 6-7 Jul 2024

-48 kg

Women (2)

| Num. | Competitor | State | 1 | 2 | Wins | Points |
|------|------------------|--------|---|---|------|--------|
| 1. | GHIGLIONE Giulia | Italy | | 0 | 0 | 0 |
| 2. | URDIALES Manon | France | 1 | | 1 | 1 |

| | | |
|--|------------------|-----|
| | GHIGLIONE Giulia | ITA |
| | URDIALES Manon | FRA |

1

URDIALES M. (FRA)

00 s0 / 01 s1 [04:32]

| FINAL RESULTS | |
|-------------------|-----|
| 1. URDIALES Manon | FRA |





Tallinn European Open 2024

Estonia, Tallinn, 6-7 Jul 2024

-52 kg

Women (16)

POOL A

| | | |
|--|-----------------------|-----|
| | WURFEL Annika | GER |
| | DE LUCA Giulia Italia | ITA |
| | CIESLIK Klaudia | POL |
| | GALSTJAN Laura | LAT |

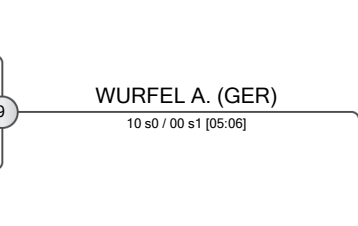
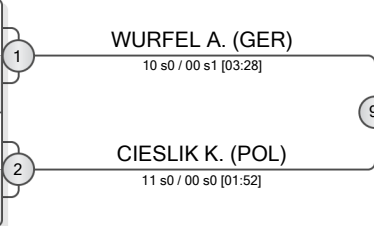

POOL B

| | | |
|--|--------------------|-----|
| | SERRA Chiara | GER |
| | MIHHAILOVA Darja | EST |
| | BOBROWSKA Sian | GBR |
| | CHEVALIER Mathilde | FRA |

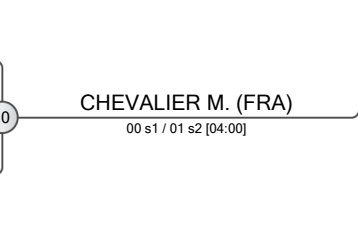
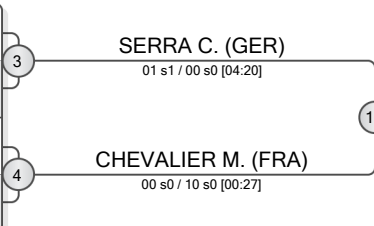

POOL C

| | | |
|--|---------------------|-----|
| | CASTAGNOLA Martina | ITA |
| | KIVIOJA Kadi | EST |
| | RIBOULON Cloe | FRA |
| | VAN DER SALM Franka | NED |

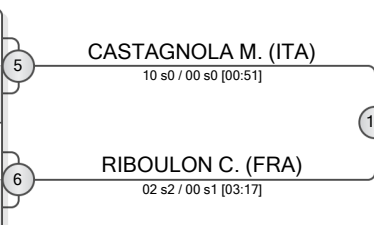

POOL D

| | | |
|--|----------------|-----|
| | MUMINOVIQ Erza | KOS |
| | BARBER Caitlin | GBR |
| | BORODINA Anna | UKR |
| | SAMEC Nusa | SLO |

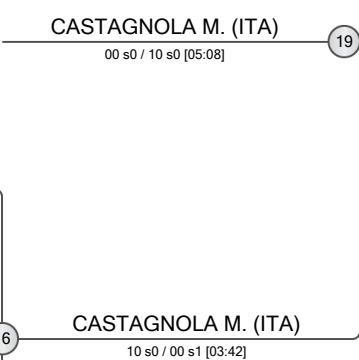
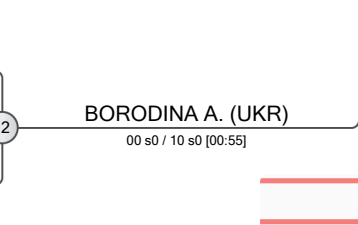
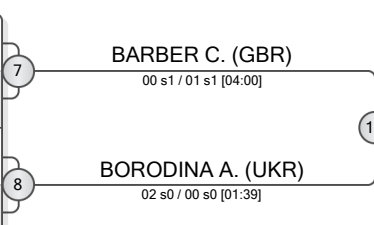

REPECHAGE

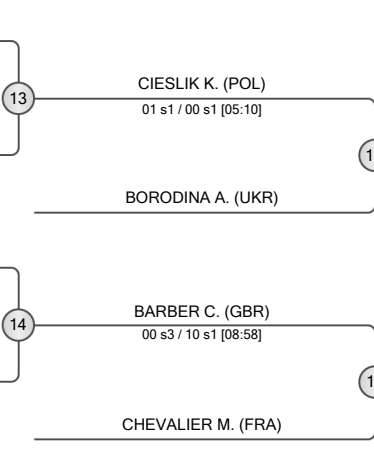

| FINAL RESULTS | | |
|---------------|--------------------|-----|
| 1. | CASTAGNOLA Martina | ITA |
| 2. | WURFEL Annika | GER |
| 3. | CIESLIK Klaudia | POL |
| 3. | BARBER Caitlin | GBR |
| 5. | BORODINA Anna | UKR |
| 5. | CHEVALIER Mathilde | FRA |
| 7. | SERRA Chiara | GER |
| 7. | RIBOULON Cloe | FRA |



POOL A

| | | |
|--|-------------------|-----|
| | CORNELISSE Pleuni | NED |
| | RASPE Vera | NED |
| | SOLLEY Lanina | GBR |

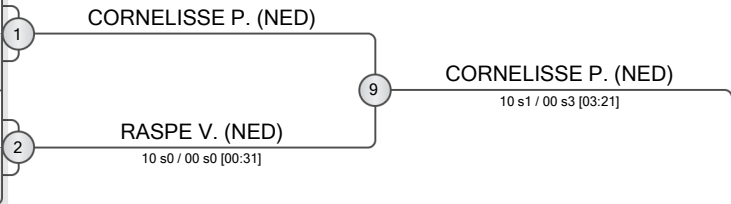

POOL B

| | | |
|--|-----------------------|-----|
| | CHYZHEVSKA Anastasiia | UKR |
| | PELLITTERI Silvia | ITA |
| | JANSSEN Danique | NED |
| | NURM Anna Liisa | EST |

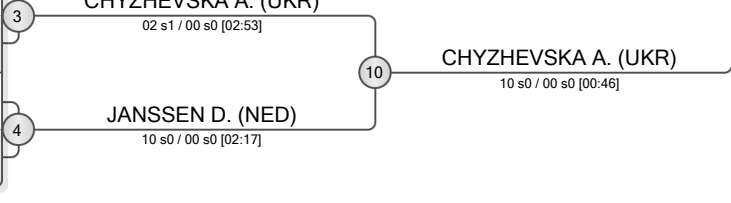

POOL C

| | | |
|--|--------------------|-----|
| | LOXHA Flaka | KOS |
| | BORDINSKYKH Sofiia | UKR |
| | TARKUS Merit | EST |
| | VERFAILLIE Luna | BEL |

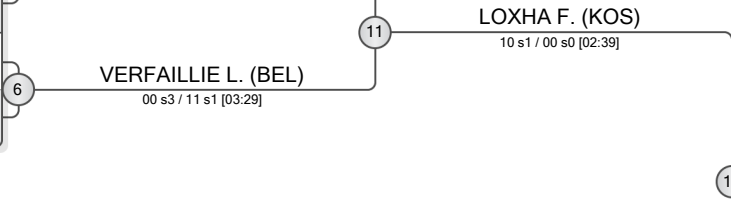

POOL D

| | | |
|--|-----------------|-----|
| | ZIEGLER Jana | GER |
| | SHYLOVA Alina | UKR |
| | GAJIC Jevgenija | SLO |
| | LAIHO Venla | FIN |

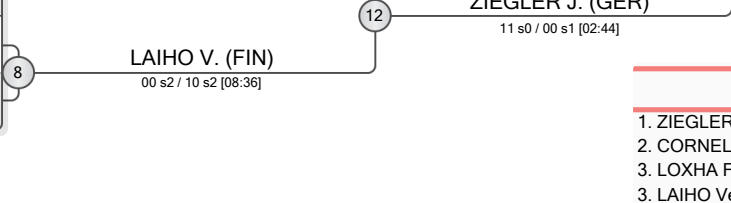

REPECHAGE

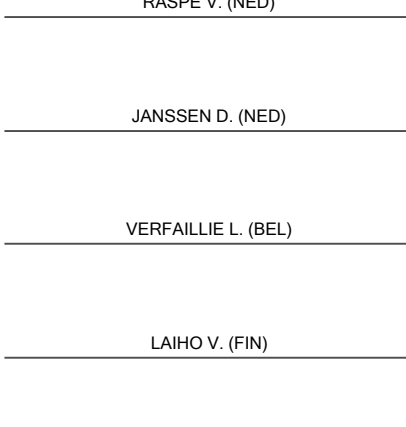

| FINAL RESULTS | | |
|---------------|-----------------------|-----|
| 1. | ZIEGLER Jana | GER |
| 2. | CORNELISSE Pleuni | NED |
| 3. | LOXHA Flaka | KOS |
| 3. | LAIHO Venla | FIN |
| 5. | JANSSEN Danique | NED |
| 5. | CHYZHEVSKA Anastasiia | UKR |
| 7. | RASPE Vera | NED |
| 7. | VERFAILLIE Luna | BEL |



Tallinn European Open 2024

Estonia, Tallinn, 6-7 Jul 2024

-63 kg

Women (19)

POOL A

| | | | | |
|--|-----------------|-----|---|-------------------|
| | GLUBIAK Martyna | POL | 1 | GLUBIAK M. (POL) |
| | SEDLMAIR Hanna | GER | 2 | SEDLMAIR H. (GER) |
| | DAAMEN Maartje | NED | 3 | DAAMEN M. (NED) |
| | KITCHEN Isobel | GBR | 4 | KITCHEN I. (GBR) |

POOL B

| | | | | |
|--|-----------------------|-----|---|-------------------------|
| | SAINT ETIENNE Perrine | FRA | 5 | SAINT ETIENNE P. (FRA) |
| | BAUER Bettina | GER | 6 | BAUER B. (GER) |
| | FOLGER Viktoria | GER | 7 | FOLGER V. (GER) |
| | VAN DE MEEBERG Rachel | NED | 8 | VAN DE MEEBERG R. (NED) |
| | NARVA Ada-Alexia | FIN | | |

POOL C

| | | | | |
|--|------------------------|-----|----|-----------------------|
| | CHRISTENSEN Helene | DEN | 9 | CHRISTENSEN H. (DEN) |
| | VON LEUPOLDT Charlotte | GER | 10 | VON LEUPOLDT C. (GER) |
| | NALBAT Kamile | NED | 11 | NALBAT K. (NED) |
| | KAPPLER Sarah | GER | 12 | KAPPLER S. (GER) |
| | LIPPUS Henrietta | EST | | |

POOL D

| | | | | |
|--|---------------------|-----|----|-------------------|
| | ANTIPINA Anastasiia | UKR | 13 | ANTIPINA A. (UKR) |
| | CABANNE Aurore | FRA | 14 | CABANNE A. (FRA) |
| | KROON Esmee | NED | 15 | KROON E. (NED) |
| | FISCHER Malin | GER | 16 | AVANZATO C. (ITA) |
| | AVANZATO Carlotta | ITA | | |

REPECHAGE

| | | | | | | |
|------------------------|----|------------------------|-----------------------|----|-------------------|-----------------------|
| DAAMEN M. (NED) | 29 | SAINT ETIENNE P. (FRA) | 00 s2 / 02 s1 [02:59] | 33 | AVANZATO C. (ITA) | 00 s0 / 11 s0 [01:50] |
| SAINT ETIENNE P. (FRA) | | | | | AVANZATO C. (ITA) | |
| VON LEUPOLDT C. (GER) | 30 | VON LEUPOLDT C. (GER) | 10 s0 / 00 s1 [02:16] | 34 | FOLGER V. (GER) | 00 s0 / 01 s1 [04:00] |
| ANTIPINA A. (UKR) | | | | | FOLGER V. (GER) | |

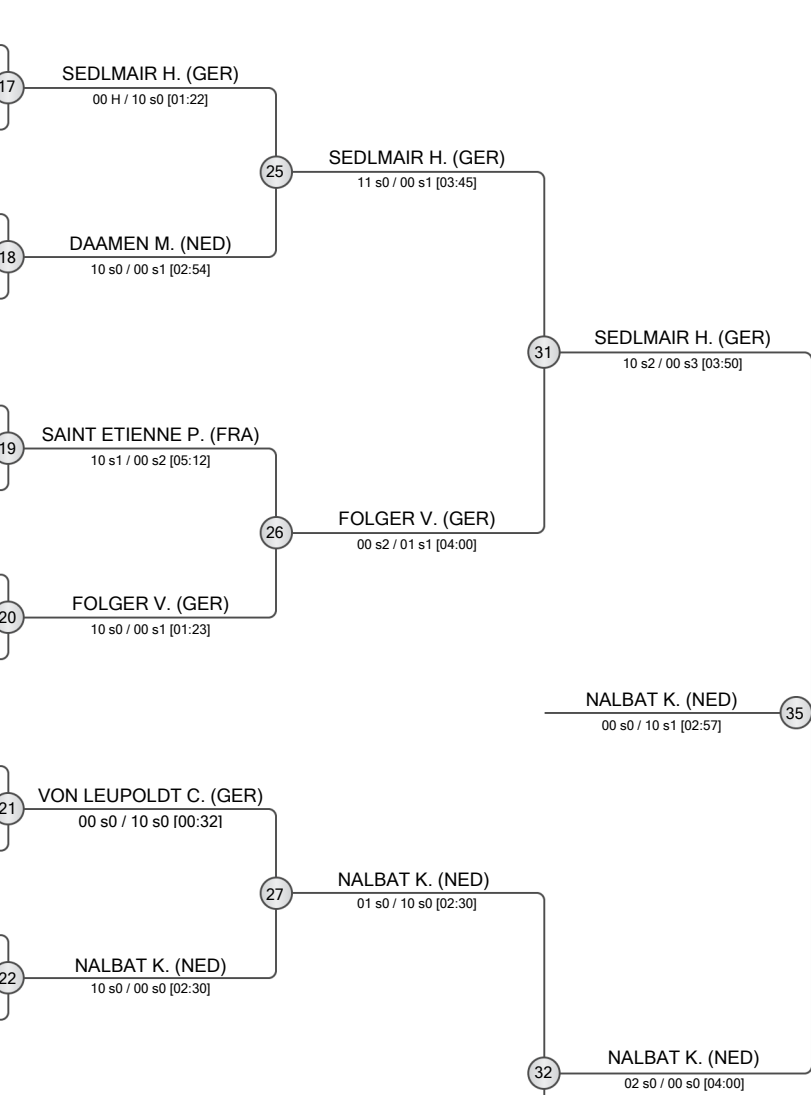

| FINAL RESULTS | |
|---------------|-----------------------|
| 1. | NALBAT Kamile |
| 2. | SEDLMAIR Hanna |
| 3. | AVANZATO Carlotta |
| 3. | FOLGER Viktoria |
| 5. | SAINT ETIENNE Perrine |
| 7. | DAAMEN Maartje |
| 7. | ANTIPINA Anastasiia |





Tallinn European Open 2024

Estonia, Tallinn, 6-7 Jul 2024

-70 kg
Women (13)

POOL A

| | | |
|--|------------------|-----|
| | BUTKEREIT Miriam | GER |
| | SCHUTJES Lotte | NED |
| | TSIMKO Olga | UKR |

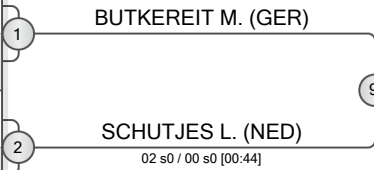

POOL B

| | | |
|--|-------------------|-----|
| | MEHLAU Sarah | GER |
| | PAPP Maria | EST |
| | BARBAUD Gabrielle | FRA |
| | NARVA Anni-Olivia | FIN |

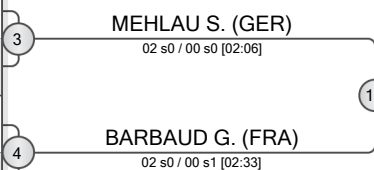

POOL C

| | | |
|--|----------------------------|-----|
| | VAN WONDEREN Dagmar | NED |
| | FRANZOSI Ludovica | ITA |
| | GORGUET-VERANES Maidelines | ROU |

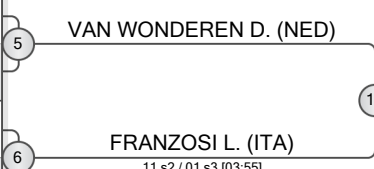

POOL D

| | | |
|--|-----------------|-----|
| | HEYNS Maxine | BEL |
| | MURPHY Bertille | GER |
| | TEPPO Unna | FIN |

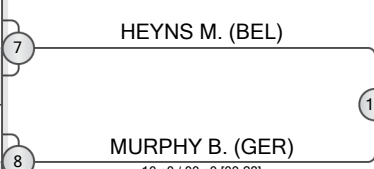

REPECHAGE

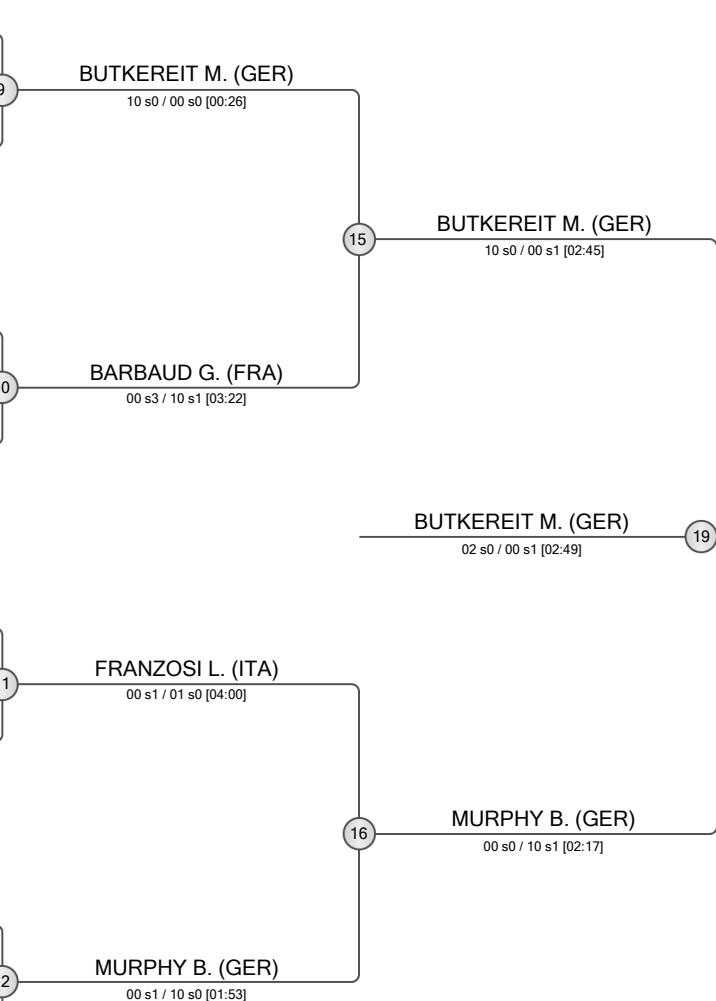

| FINAL RESULTS | | |
|---------------|---------------------|-----|
| 1. | BUTKEREIT Miriam | GER |
| 2. | MURPHY Bertille | GER |
| 3. | MEHLAU Sarah | GER |
| 3. | BARBAUD Gabrielle | FRA |
| 5. | FRANZOSI Ludovica | ITA |
| 5. | VAN WONDEREN Dagmar | NED |
| 7. | SCHUTJES Lotte | NED |
| 7. | HEYNS Maxine | BEL |





Tallinn European Open 2024

Estonia, Tallinn, 6-7 Jul 2024

-78 kg

Women (10)

POOL A

| | | |
|--|------------------------|-----|
| | DUDENAITE Migle Julija | LTU |
| | SCHMID Lea | GER |
| | LUDFORD Shelley | GBR |

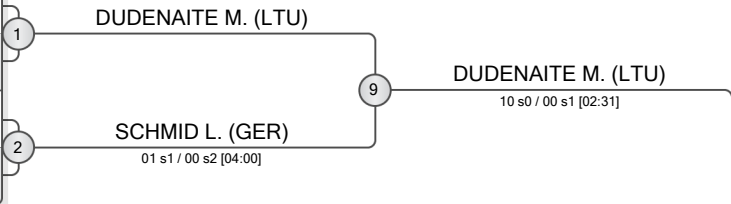

POOL B

| | | |
|--|-------------------|-----|
| | HOELTERHOFF Julie | GER |
| | CALEO Irene | ITA |

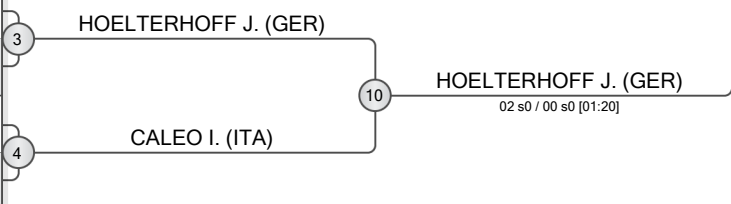

POOL C

| | | |
|--|--------------------------|-----|
| | BUDDENKOTTE Eva Ronja | GER |
| | KRAPU Emma | FIN |
| | NIEMEYER Mathilda Sophie | GER |

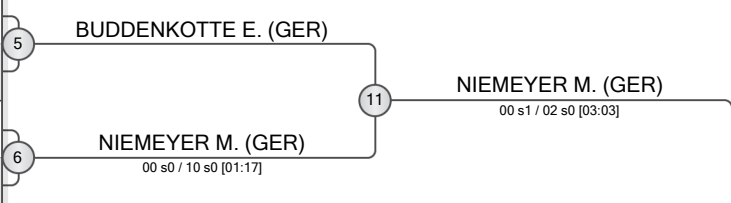

POOL D

| | | |
|--|----------------|-----|
| | LUDEMA Berber | NED |
| | DZIOPA Paulina | POL |

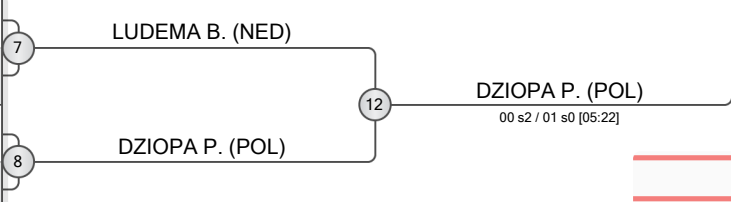

| FINAL RESULTS | | |
|---------------|--------------------------|-----|
| 1. | NIEMEYER Mathilda Sophie | GER |
| 2. | HOELTERHOFF Julie | GER |
| 3. | SCHMID Lea | GER |
| 3. | BUDDENKOTTE Eva Ronja | GER |
| 5. | DZIOPA Paulina | POL |
| 7. | CALEO Irene | ITA |
| 7. | LUDEMA Berber | NED |

REPECHAGE

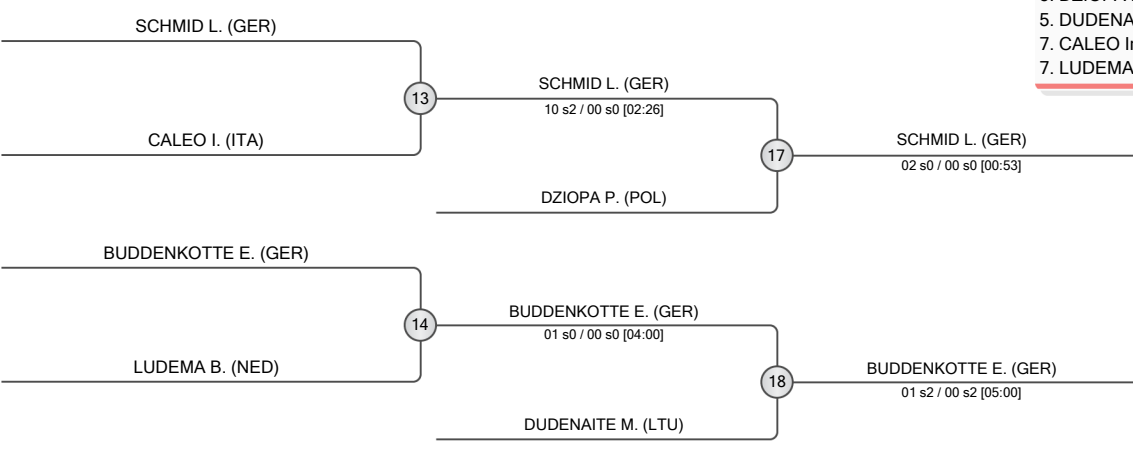

POOL A

ANDREWS Sydnee NZL
 AKTAS Emma-Melis EST

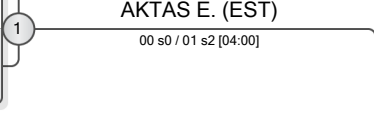

POOL B

SWEERS Paulien NED
 ZATCHI BI Oceane FRA

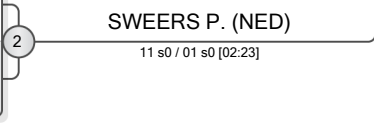

POOL C

SIMONETTI Erica ITA
 LIS Wiktoria POL

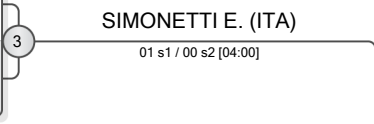

POOL D

BULAVINA Ruslana UKR
 STASIULYTE Rugile LTU

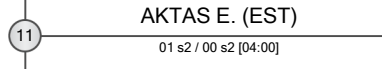
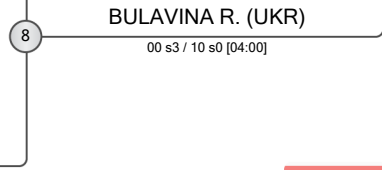
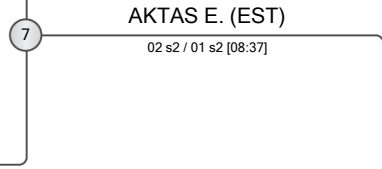
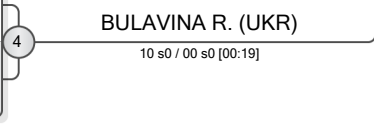

| FINAL RESULTS | |
|---------------------|-----|
| 1. AKTAS Emma-Melis | EST |
| 2. BULAVINA Ruslana | UKR |
| 3. SIMONETTI Erica | ITA |
| 3. SWEERS Paulien | NED |
| 5. ANDREWS Sydnee | NZL |
| 5. LIS Wiktoria | POL |

REPECHAGE

