

265 competitors from 18 nations

181 Men

84 Women





-50 kg	-55 kg	-60 kg	-66 kg	-73 kg	-81 kg	-90 kg	+90 kg	Men
14	16	26	37	35	24	17	12	181









-40 kg	-44 kg	-48 kg	-52 kg	-57 kg	-63 kg	-70 kg	+70 kg	Women
0	7	13	13	20	16	10	5	84







Continent	AJU	JUA	EJU	OJU	PJC	Total
Nations		1	16		1	18
Competitors		1	262		2	265

Schedule		
Date	19 Oct	20 Oct
Start	10:00	10:00
Finals	15:30	15:00

-50 kg		
1	ALEKSIEJUNAS Natas	LTU 
2	KOSTOEV Adam	SWE 
3	HERMANN Leon	GER 
3	DOBROWOLSKI Bartlomiej	POL 
5	SPINU Arsenijs	LAT 
5	CIMBOLAS Timas	LTU 
7	RAUDENIEKS Markus	LAT 
7	BRIDI Matteo	ITA 









-55 kg		
1	JAKUBAUSKAS Adris	LTU 
2	ANDERSON Evan	GBR 
3	KAZANA Kamil	POL 
3	MAKULAVICIUS Rokas	LTU 
5	SIENKIEWICZ Ryszard	POL 
5	WENCEL Jakub	POL 
7	SAULITE Toms	LAT 
7	GUCALUKS Kristaps	LAT 

-60 kg		
1	MUNIZ ACOSTA Jakub	POL 
2	SWITALA Pawel	POL 
3	AZARUMYAN Artak	EST 
3	POBLOCKI Samir	SWE 
5	WISNIEWSKI Dawid	POL 
5	JACKEVICIUS Rokas	LTU 
7	TANG Samuel	GBR 
7	MICHALAK Wojciech	POL 

-66 kg		
1	GUBBERUD Nino	NOR 
2	KARALEVICIUS Zygimantas	LTU 
3	NOGES Georg	EST 
3	LISZKA Konrad	POL 
5	FERENC Wojciech	POL 
5	HOMKA Eriks	LAT 
7	ZUGICKIS Markuss	LAT 
7	VAGULIS Danas	LTU 







-73 kg		
1	KULLO Tits	LAT 
2	ZVANERS Daniels	LAT 
3	GUDEJEVS Arsenijs	LAT 
3	MARLOV Alexander	SWE 
5	BORZECKI Jakub	POL 
5	ZBYTNIIEWSKI Aleksander	POL 
7	BECKER Georg	GER 
7	STANKEVICIUS Ignas	LTU 









-81 kg		
1	AVDEJEVS Aleksandrs	LAT 
2	BUMAZKINS Jelisejs	LAT 
3	BABAICENKO Tajus	LTU 
3	POPOVS Maksims	LAT 
5	JACENKO Arturs	LAT 
5	BOJANOWSKI Michal	POL 
7	ZARINS Ricards	LAT 
7	BETKOWSKI Jeremiasz	POL 





-90 kg		
1	MANFELDS Tomass	LAT 
2	GENYS Majus	LTU 
3	PETRAUSKAS Majus	LTU 
3	LIAUGAUDAS Matas	LTU 
5	ZILYS Tomas	LTU 
5	RUDI Lennox	GER 
7	NILLER Jaan	EST 
7	SUNDBY Marius	NOR 









+90 kg		
1	MASAK Marek-Adrian	EST 
2	KHACHATRYAN Anton	POL 
3	AFANASJEVS Nikita	LAT 
3	BLAZEVICIS Artemijs	LAT 
5	TAURA Patrikas	LTU 
5	APSALENS Aleksandrs	LAT 
7	MASTEIKA Titas	LTU 
7	NESTEROVS Vadims	LAT 

-40 kg		









-44 kg		
1	GASHI Blerina	KOS 
2	WALENDZIK Sandra	POL 
3	LAVRINJOVA Marija	EST 
3	AZARUMYAN Anna	EST 
5	PUOMILAHTI Iida	FIN 
5	BLASZCZYK Julia	POL 



-48 kg		
1	TWAROWSKA Barbara	POL 
2	HERTA Gabriela	MDA 
3	CHRISP Taylor	GBR 
3	PODYMSKA Nina	POL 
5	CZERWINSKA-KOWAR Roksana	POL 
5	BROVOLD Selma	NOR 
7	ARTEAGA Evelin	SWE 
7	LAPS Martyna	POL 

-52 kg		
1	MOS Marika	POL 
2	GRZESZCZYK Otylia	POL 
3	CORDOVA Sofia	SWE 
3	ROBINSON Lucy	GBR 
5	ZARUBA Viktorija	LTU 
5	TAIT Angelica	ITA 
7	KARNA Olivia	FIN 
7	GREGOR Stefanie	GER 

-57 kg		
1	WALEGA Magdalena	POL 
2	SKERYTE Ugne	LTU 
3	PEKKI Sofia	FIN 
3	BABULFATH Hanna	SWE 
5	LAPPETELAINEN Essi	FIN 
5	GOTTSCHALK Mia Loreen	GER 
7	BORCZ Blanka	POL 
7	AUBERT GOMEZ Maya	GBR 

-63 kg		
1	BUETTNER Alesia	GER 
2	WOZNICZKO Nadia	POL 
3	DALMASSO Madeleine	FRA 
3	THOMSON Maia	CAN 
5	DUDA Julia	POL 
5	KORDEL Mira	SWE 
7	WITTGREN Wilda	SWE 
7	GRAMBO Anna	NOR 

-70 kg		
1	BENKOVA Diana	POL 
2	OLSZEWSKA Kinga	POL 
3	POGOSYAN Gayane	EST 
3	ZYS Roksana	POL 
5	LATKOWSKI Antonia	GER 
5	STALIONYTE Paulina	LTU 
7	ISAJEVA Anastasija	LAT 
7	ARUKAEVU Getter	EST 

+70 kg		
1	TROKA Julia	POL 
2	ZAREBA Nikola	POL 
3	EININGE Saule	LTU 



Medals

Riga Cadet European Cup 2024, 19-20 Oct 2024

Medals

#	Nation		1. Place	2. Place	3. Place	5. Place	7. Place
1.		POL Poland	6	7	5	10	4
2.		LAT Latvia	3	2	4	4	7
3.		LTU Lithuania	2	3	5	6	3
4.		EST Estonia	1		5		2
5.		GER Germany	1		1	3	2
6.		NOR Norway	1			1	2
7.		KOS Kosovo	1				
8.		SWE Sweden		1	4	1	2
9.		GBR Great Britain		1	2		2
10.		MDA Republic of Moldova		1			
11.		FIN Finland			1	2	1
12.		CAN Canada			1		
12.		FRA France			1		
14.		ITA Italy				1	1

Official person:



Statistics

Riga Cadet European Cup 2024, 19-20 Oct 2024

Statistics

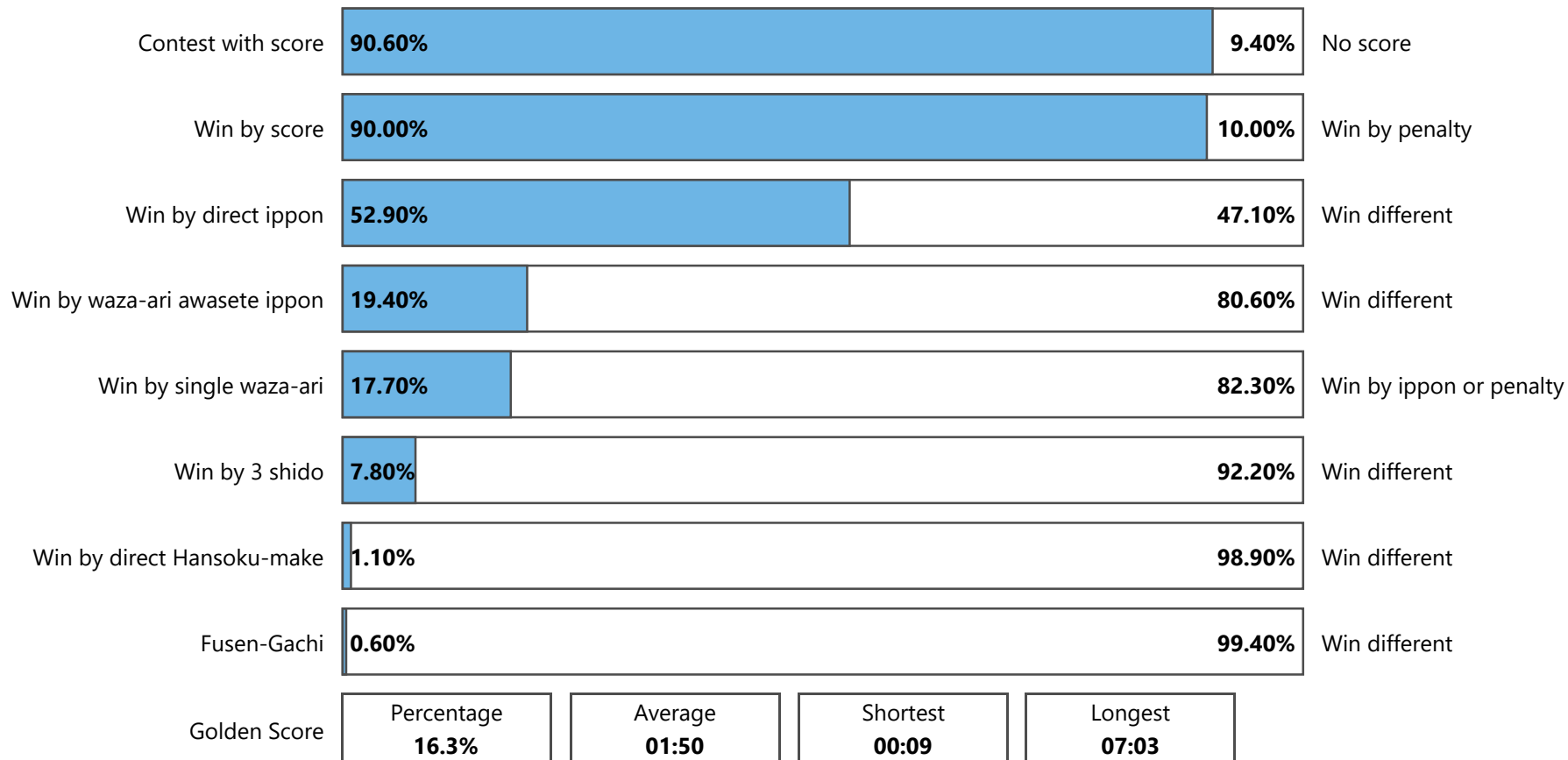



Statistics

Riga Cadet European Cup 2024, 19-20 Oct 2024

Statistics

	-50	-55	-60	-66	-73	-81	-90	+90	M	-40	-44	-48	-52	-57	-63	-70	+70	W	Total
Competitors	14	16	26	37	35	24	17	12	181		7	13	13	20	16	10	5	84	265
Contests	19	23	36	50	46	33	24	16	247		9	18	17	27	23	14	6	114	361
Contests with score	19	20	31	46	44	31	21	15	227		8	14	17	25	20	10	6	100	327
Contests with score %	100%	87%	86.1%	92%	95.7%	93.9%	87.5%	93.8%	91.9%	0%	88.9%	77.8%	100%	92.6%	87%	71.4%	100%	87.7%	90.6%
Wins by Score	18	20	31	46	44	31	20	14	224		9	14	17	25	20	10	6	101	325
Wins by Score %	94.7%	87%	86.1%	92%	95.7%	93.9%	83.3%	87.5%	90.7%	0%	100%	77.8%	100%	92.6%	87%	71.4%	100%	88.6%	90.0%
Wins by direct Ippon	9	11	18	24	25	23	13	10	133		2	10	9	16	11	6	4	58	191
Wins by direct Ippon %	47.4%	47.8%	50%	48%	54.3%	69.7%	54.2%	62.5%	53.8%	0%	22.2%	55.6%	52.9%	59.3%	47.8%	42.9%	66.7%	50.9%	52.9%
Wins by Waza-ari Awasete Ippon	1	2	4	14	10	6	5	1	43		5	2	4	6	7	1	2	27	70
Wins by Waza-ari Awasete Ippon %	5.3%	8.7%	11.1%	28%	21.7%	18.2%	20.8%	6.3%	17.4%	0%	55.6%	11.1%	23.5%	22.2%	30.4%	7.1%	33.3%	23.7%	19.4%
Wins by single Waza-ari	8	7	9	8	9	2	2	3	48		2	2	4	3	2	3		16	64
Wins by single Waza-ari %	42.1%	30.4%	25%	16%	19.6%	6.1%	8.3%	18.8%	19.4%	0%	22.2%	11.1%	23.5%	11.1%	8.7%	21.4%	0%	14.0%	17.7%
Wins by 3 Shido for opponent	1	2	5	4	2	1	3	2	20			4		1	1	2		8	28
Wins by 3 Shido for opponent %	5.3%	8.7%	13.9%	8%	4.3%	3%	12.5%	12.5%	8.1%	0%	0%	22.2%	0%	3.7%	4.3%	14.3%	0%	7.0%	7.8%
Direct Hansoku-make		1							1					1	2			3	4
Wins by direct Hansoku-make %	0%	4.3%	0%	0%	0%	0%	0%	0%	0.4%	0%	0%	0%	0%	3.7%	8.7%	0%	0%	2.6%	1.1%
Fusen-gachi						1	1		2										2
Fusen-gachi %	0%	0%	0%	0%	0%	3%	4.2%	0%	0.8%	0%	0%	0%	0%	0%	0%	0%	0%	0%	0.6%
All positive Scores (Waza-ari + direct Ippon)	20	22	39	69	65	45	29	19	308		14	21	28	34	31	14	8	150	458
Average Scores per contests	1.1	1	1.1	1.4	1.4	1.4	1.2	1.2	1.22		1.6	1.2	1.6	1.3	1.3	1	1.3	1.16	1.19
All penalties (Shido + HSK)	31	35	53	54	58	22	41	24	318		3	32	8	23	23	17	8	114	432
Average penalty per contest	1.6	1.5	1.5	1.1	1.3	0.7	1.7	1.5	1.36		0.3	1.8	0.5	0.9	1	1.2	1.3	0.88	1.12
Golden Score	5	6	8	10	7	2	1	1	40			6	2	2	2	5	2	19	59
Golden Score %	26.3%	26.1%	22.2%	20%	15.2%	6.1%	4.2%	6.3%	16.2%	0%	0%	33.3%	11.8%	7.4%	8.7%	35.7%	33.3%	16.7%	16.3%
Osae-komi	3	18	11	34	13	15	18	5	117		8	4	10	15	5	7	1	50	167
Osae-komi %	16%	78%	31%	68%	28%	45%	75%	31%	47.4%	0%	89%	22%	59%	56%	22%	50%	17%	43.9%	46.3%
Wins by Penalty	1	3	5	4	2	1	3	2	21			4		2	3	2		11	32



Nations Overview

Riga Cadet European Cup 2024, 19-20 Oct 2024

Nations

Overview

			-50	-55	-60	-66	-73	-81	-90	+90	M	-40	-44	-48	-52	-57	-63	-70	+70	W	Total	D	
1.		BIH	Bosnia and Herzegovina	0	0	0	0	1	1	0	0	2	0	0	0	0	0	0	0	0	0	2	1
2.		CAN	Canada	0	0	0	0	0	0	1	1	0	0	0	0	0	1	0	0	1	1	2	0
3.		EST	Estonia	0	3	2	5	4	5	4	1	24	0	2	0	0	0	1	2	1	6	30	8
4.		FIN	Finland	1	1	1	2	1	0	2	1	9	0	1	1	1	3	0	0	0	6	15	2
5.		FRA	France	0	0	0	0	0	0	0	0	0	0	0	0	0	1	0	0	1	1	2	
6.		GBR	Great Britain	0	1	1	0	0	0	0	0	2	0	0	1	2	1	0	0	0	4	6	3
7.		GER	Germany	1	2	2	2	4	2	1	0	14	0	0	0	1	4	2	1	0	8	22	7
8.		ITA	Italy	1	0	1	0	0	0	0	0	2	0	0	1	1	0	0	0	0	2	4	2
9.		KGZ	Kyrgyzstan	0	1	0	0	0	0	0	0	1	0	0	0	0	0	0	0	0	0	1	1
10.		KOS	Kosovo	0	0	0	0	0	0	0	0	0	0	1	0	0	0	0	0	0	1	1	1
11.		LAT	Latvia	3	2	8	10	12	10	1	4	50	0	0	1	2	2	2	1	0	8	58	21
12.		LTU	Lithuania	4	2	2	9	5	1	5	3	31	0	1	0	1	2	1	1	1	7	38	7
13.		MDA	Republic of Moldova	1	0	0	1	0	0	0	0	2	0	0	1	0	0	0	0	0	1	3	1
14.		NOR	Norway	0	0	1	1	0	1	1	0	4	0	0	1	0	1	1	0	0	3	7	2
15.		POL	Poland	1	4	5	4	4	2	2	2	24	0	2	4	2	3	4	4	3	22	46	19
16.		POR	Portugal	1	0	2	1	1	1	1	0	7	0	0	1	1	1	1	0	0	4	11	2
17.		SVK	Slovakia	0	0	0	0	0	0	0	0	0	0	0	1	1	0	0	0	2	2	1	
18.		SWE	Sweden	1	0	1	2	3	1	0	0	8	0	0	2	1	2	2	1	0	8	16	5
				14	16	26	37	35	24	17	12	181	0	7	13	13	20	16	10	5	84	265	85



Riga Cadet European Cup 2024

Latvia, Riga, 19-20 Oct 2024

-50 kg

Men (14)

POOL A

	ALEKSIEJUNAS Natas	LTU
	SILEN Topi	FIN
	SPINU Arsenijs	LAT

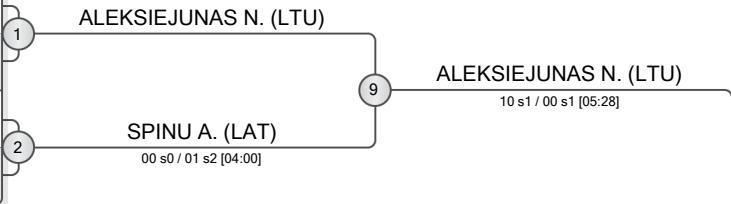

POOL B

	CARP Maxim	MDA
	ZUKAUSKAS Matas	LTU
	RAUDENIEKS Markus	LAT
	DOBROWOLSKI Bartlomiej	POL

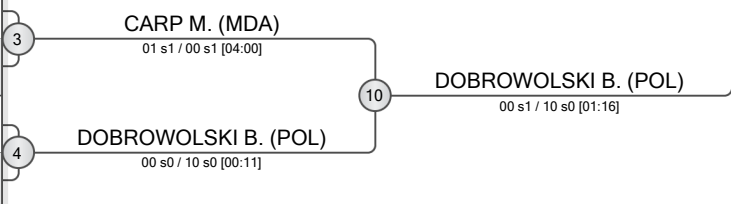

POOL C

	HERMANN Leon	GER
	BELIK Vadim	LTU
	BRIDI Matteo	ITA

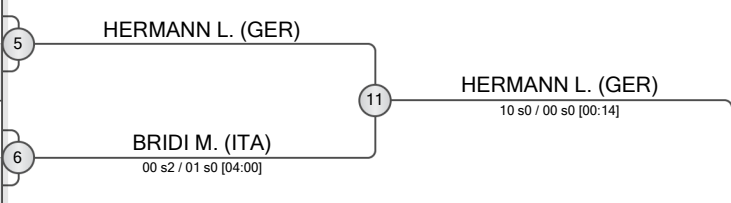

POOL D

	CIMBOLAS Timas	LTU
	CALADO Daniel	POR
	MARCENKO Artjoms	LAT
	KOSTOEV Adam	SWE

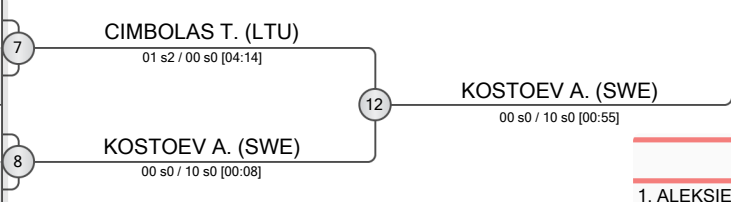

REPECHAGE

13 SPINU A. (LAT)	14 RAUDENIEKS M. (LAT)	15 BRIDI M. (ITA)	16 CIMBOLAS T. (LTU)
19 SPINU A. (LAT)	20 CIMBOLAS T. (LTU)	21 HERMANN L. (GER)	22 DOBROWOLSKI B. (POL)

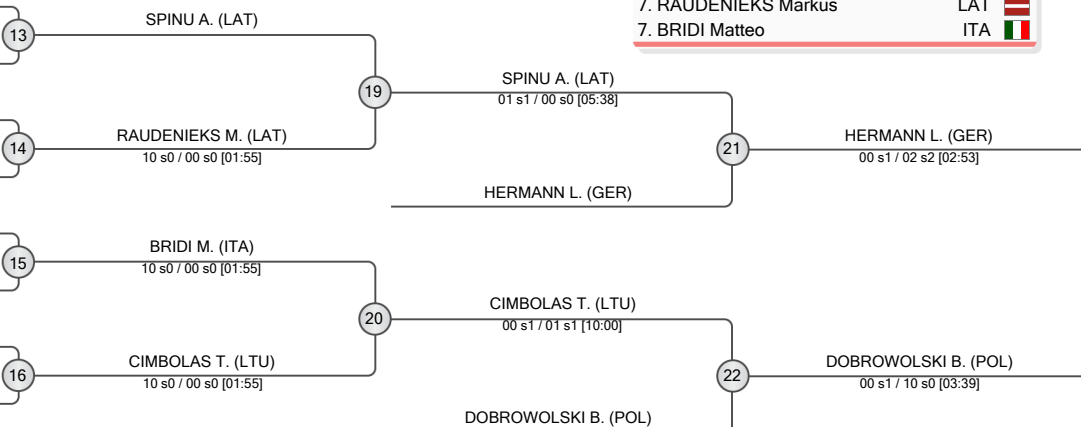

FINAL RESULTS

1.	ALEKSIEJUNAS Natas	LTU	
2.	KOSTOEV Adam	SWE	
3.	HERMANN Leon	GER	
3.	DOBROWOLSKI Bartlomiej	POL	
5.	SPINU Arsenijs	LAT	
5.	CIMBOLAS Timas	LTU	
7.	RAUDENIEKS Markus	LAT	
7.	BRIDI Matteo	ITA	





Riga Cadet European Cup 2024

Latvia, Riga, 19-20 Oct 2024

-55 kg

Men (16)

POOL A

	MAKULAVICIUS Rokas	LTU
	SAULITE Toms	LAT
	CZALBOWSKI Szymon	POL
	POHJA Totti	FIN

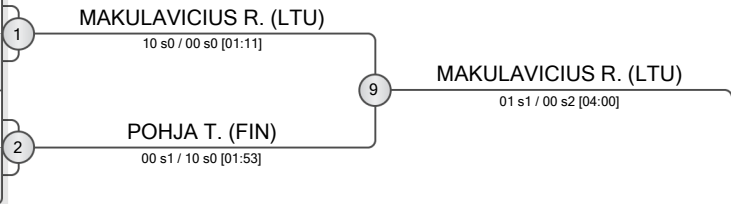

POOL B

	SIENKIEWICZ Ryszard	POL
	CORDES Ben	GER
	ANDERSON Evan	GBR
	KUDEVIIITA Marten	EST

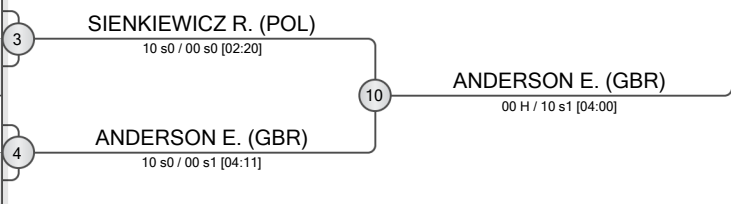

POOL C

	JAKUBAUSKAS Adris	LTU
	WENCEL Jakub	POL
	ADYLBKOV Alymbek	KGZ
	MOROZOV Aleksei	EST

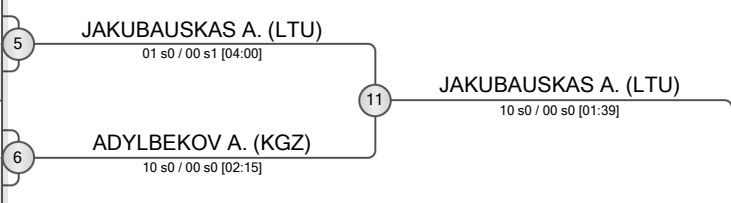

POOL D

	KAZANA Kamil	POL
	KOLOSSOV Kristo	EST
	OESTERWIND Max	GER
	GUCALUKS Kristaps	LAT

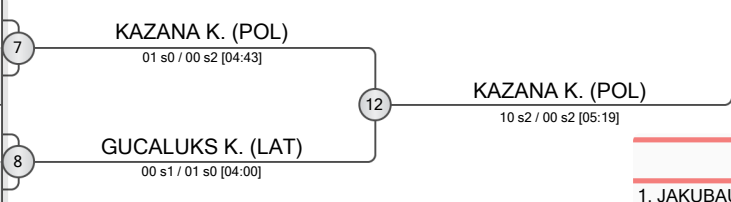

REPECHAGE

SAULITE T. (LAT)	POHJA T. (FIN)	13
KUDEVIIITA M. (EST)	SIENKIEWICZ R. (POL)	14
WENCEL J. (POL)	ADYLBKOV A. (KGZ)	15
KOLOSSOV K. (EST)	GUCALUKS K. (LAT)	16

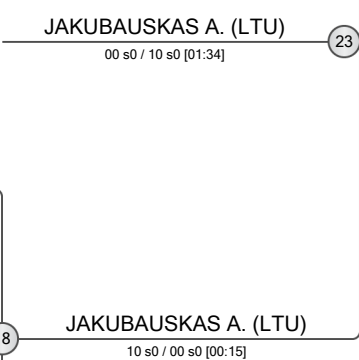
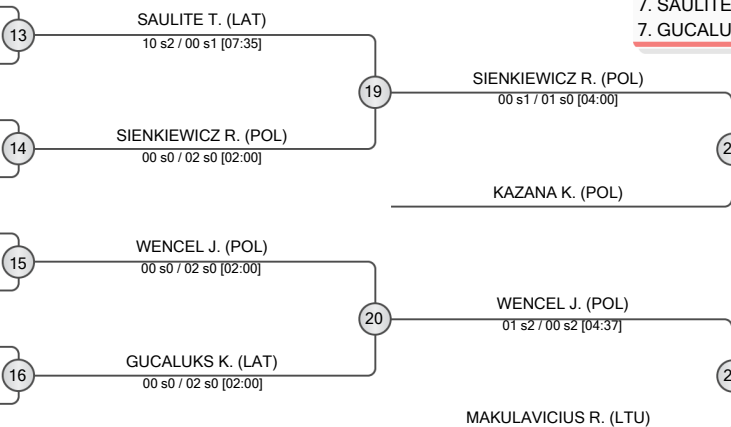

FINAL RESULTS		
1.	JAKUBAUSKAS Adris	LTU
2.	ANDERSON Evan	GBR
3.	KAZANA Kamil	POL
3.	MAKULAVICIUS Rokas	LTU
5.	SIENKIEWICZ Ryszard	POL
5.	WENCEL Jakub	POL
7.	SAULITE Toms	LAT
7.	GUCALUKS Kristaps	LAT





Riga Cadet European Cup 2024

Latvia, Riga, 19-20 Oct 2024

-60 kg

Men (26)

POOL A

	BREKKE-JENSSEN Torstein	NOR
	AZERA Rodrigo	POR
	RIEKSTS Janis	LAT
	HANISCH Quentin	GER
	AZARUMYAN Artak	EST
	ALEKSEJEVS Aleksandrs	LAT
	MUNIZ ACOSTA Jakub	POL

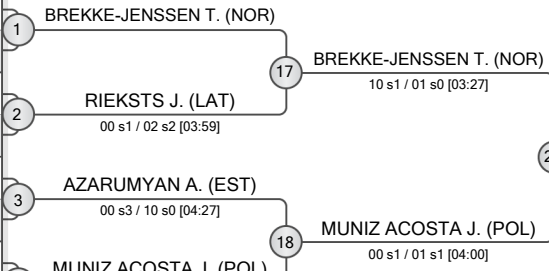

POOL B

	BALAYEV Samir	FIN
	SWOLKOWICZ Wojciech	POL
	ABALIHINS Daniels	LAT
	TANG Samuel	GBR
	FADEJEVS Artemijs	LAT
	JACKEVICIUS Rokas	LTU

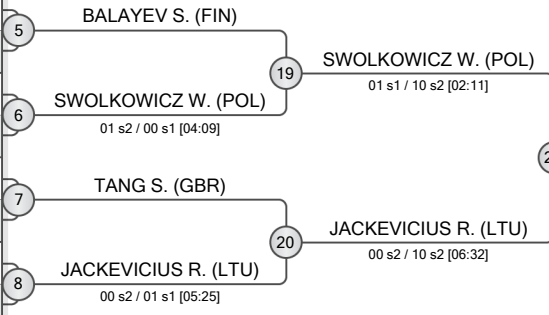

POOL C

	WISNIEWSKI Dawid	POL
	DIAS Antonio	POR
	POLISKO Ruslans	LAT
	MICHALAK Wojciech	POL
	DUDOCKINS Mareks	LAT
	BEZUGLOV Ilja	EST
	SCHUERER Hannes	GER

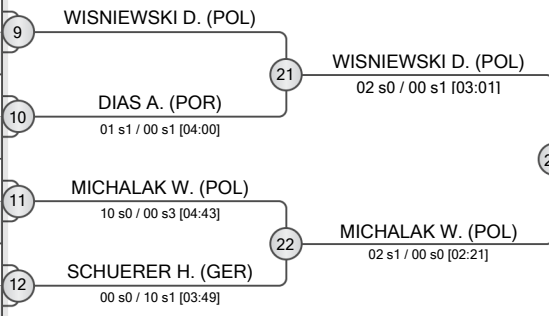

POOL D

	POBLOCKI Samir	SWE
	SADLAUSKAS Danielius	LTU
	LAZAREVS Jegors	LAT
	SWITALA Pawel	POL
	CARCANGIU Nicola	ITA
	STRAUSS Fricis Roberts	LAT

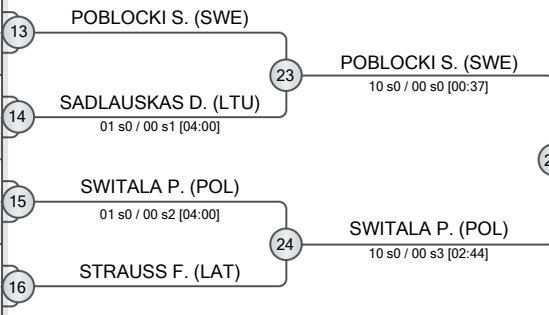

REPECHAGE

ALEKSEJEVS A. (LAT)	29 AZARUMYAN A. (EST) [01:10]
AZARUMYAN A. (EST)	30 TANG S. (GBR) [00:36]
FADEJEVS A. (LAT)	31 DIAS A. (POR)
TANG S. (GBR)	32 STRAUSS F. (LAT) [01:35]
DIAS A. (POR)	33 BREKKE-JENSSEN T. (NOR)
CARCANGIU N. (ITA)	34 SWOLKOWICZ W. (POL)
STRAUSS F. (LAT)	35 MICHALAK W. (POL) [00:48]
	36 POBLOCKI S. (SWE) [00:29]

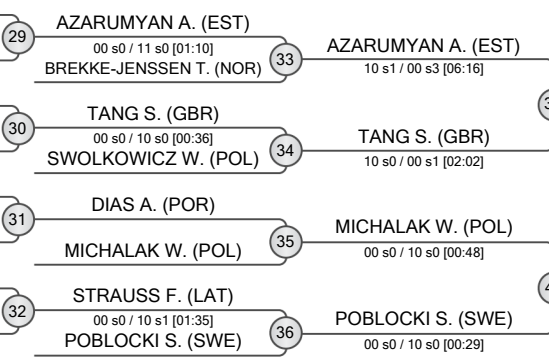

FINAL RESULTS	
1. MUNIZ ACOSTA Jakub	POL
2. SWITALA Pawel	POL
3. AZARUMYAN Artak	EST
3. POBLOCKI Samir	SWE
5. WISNIEWSKI Dawid	POL
5. JACKEVICIUS Rokas	LTU
7. TANG Samuel	GBR
7. MICHALAK Wojciech	POL





Riga Cadet European Cup 2024

Latvia, Riga, 19-20 Oct 2024

-66 kg

Men (37)

POOL A

	KARALEVICIUS Zygimantas	LTU
	BIRKHANS Toms Kristians	LAT
	HERTA David	MDA
	KASPARAVICIUS Nidijus	LTU
	ZUGICKIS Markuss	LAT
	KUTSON Kristjan	EST
	TONISSON Jonathan	FIN
	DAUKSTS Reinis	LAT
	BABRAVICIUS Vincentas	LTU

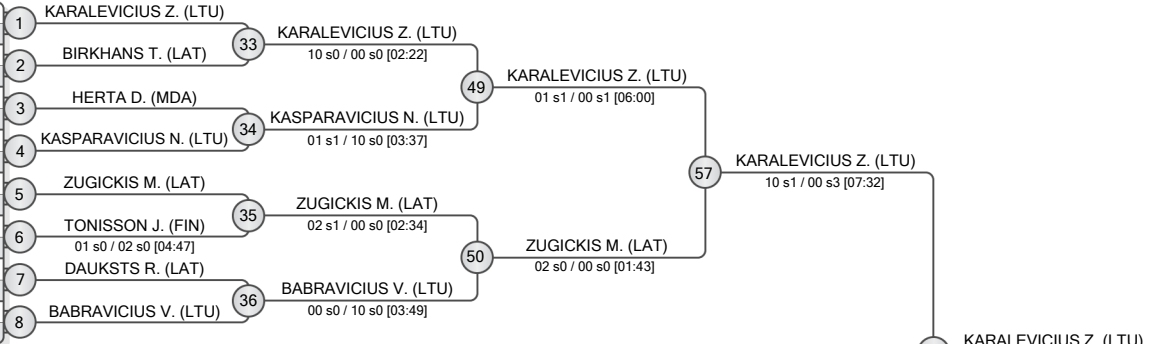

POOL B

	FERENC Wojciech	POL
	SAVICKIS Lukas	LTU
	TSCHERHEIKO Malik	GER
	HOMKA Eriks	LAT
	GEVRYIE Gabriel	SWE
	VELYKYI Artur	POL
	NARKUS Girvydas	LTU
	TAMMIN Daniel	EST
	JEKABSONS Bruno	LAT

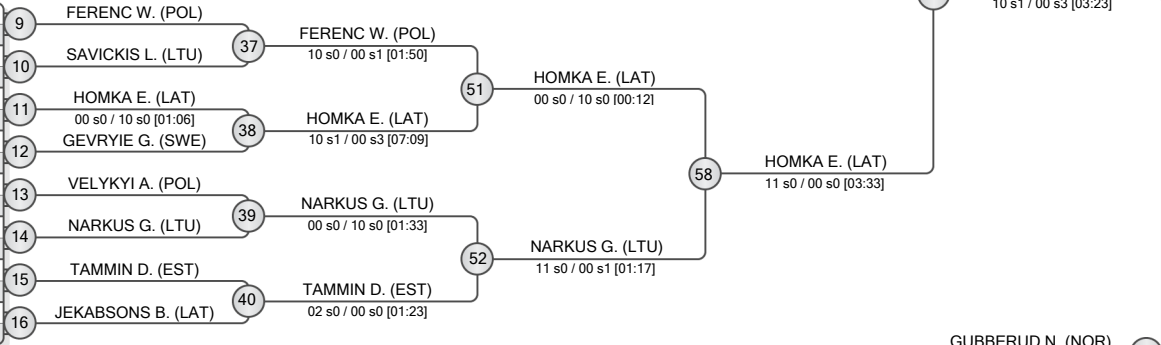

POOL C

	VAGULIS Danas	LTU
	TAMMI Gleb	FIN
	BELOGLAZOVVS Vladimirs	LAT
	TYMINSKI Maksymilian	POL
	NOGES Georg	EST
	BERG Bert	EST
	JAKOVLEVS Edvards	LAT
	CORDEIRO Vasco	POR
	MARKSAITIS Matas	LTU

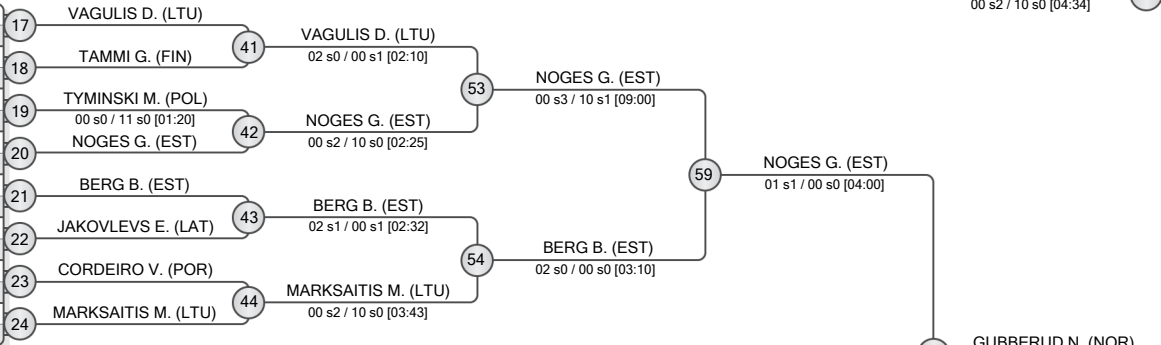

POOL D

	PEHRSON Leo	SWE
	PABERZIS Andrejs	LAT
	GUBBERUD Nino	NOR
	STANEVICIUS Aurimas	LTU
	SAVINS Avivs	LAT
	LAVRINJOV Volodomor	EST
	IVANOVAS Mantas	LTU
	LISZKA Konrad	POL
	PONOMARENKO Ivan	GER
	SERGEJEVS Aleksandrs	LAT

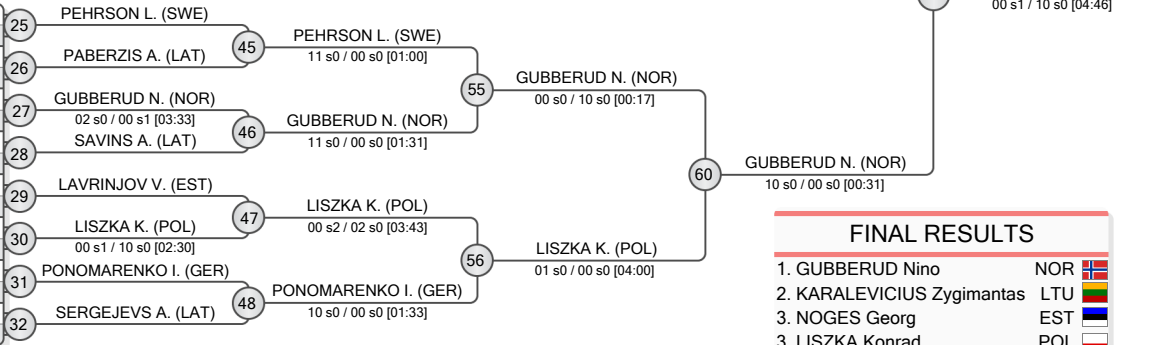

FINAL RESULTS	
1.	GUBBERUD Nino NOR
2.	KARALEVICIUS Zygimantas LTU
3.	NOGES Georg EST
3.	LISZKA Konrad POL
5.	FERENC Wojciech POL
5.	HOMKA Eriks LAT
7.	ZUGICKIS Markuss LAT
7.	VAGULIS Danas LTU

REPECHAGE

	BIRKHANS T. (LAT)	61	BIRKHANS T. (LAT)	61
	TSCHERHEIKO M. (GER)		KASPARAVICIUS N. (LTU)	65
	GEVRYIE G. (SWE)	62	ZUGICKIS M. (LAT)	69
			ZUGICKIS M. (LAT)	69
			FERENC W. (POL)	70
			NARKUS G. (LTU)	70
	TYMINSKI M. (POL)	63		
	STANEVICIUS A. (LTU)		VAGULIS D. (LTU)	71
	SAVINS A. (LAT)	64	BERG B. (EST)	71
			PEHRSON L. (SWE)	72
			LISZKA K. (POL)	76
			LISZKA K. (POL)	76

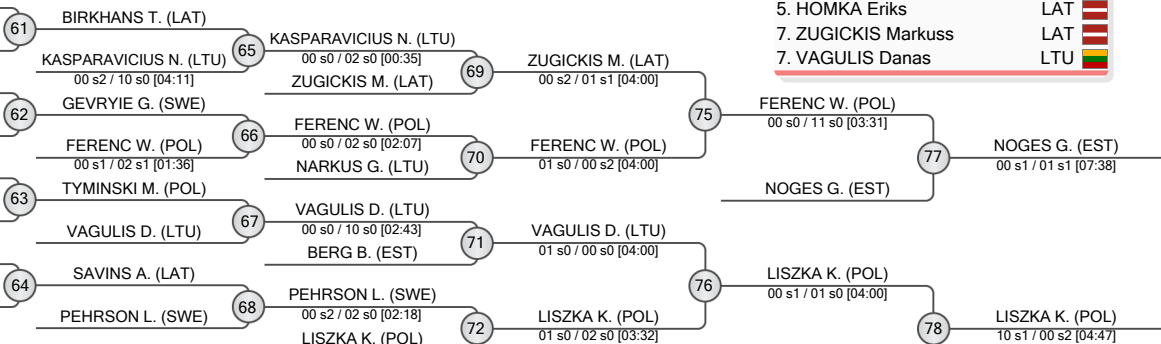



Riga Cadet European Cup 2024

Latvia, Riga, 19-20 Oct 2024

-73 kg

Men (35)

POOL A

	RACKA Norbertas	LTU	1	RACKA N. (LTU)			
	PADEL Linus	GER	2	PADEL L. (GER)	33	RACKA N. (LTU)	02 s0 / 00 s0 [02:40]
	BASMAKOVŠ Ilarions	LAT	3	BASMAKOVŠ I. (LAT)			
	HRISTOFOROV Bruno	EST	4	HRISTOFOROV B. (EST)	34	BASMAKOVŠ I. (LAT)	10 s1 / 01 s0 [02:51]
	KWIECINSKI Antoni	POL	5	KWIECINSKI A. (POL)			
	GUDEJEVS Arsenijs	LAT	6	GUDEJEVS A. (LAT)	35	GUDEJEVS A. (LAT)	00 s2 / 01 s2 [04:54]
	JAMAK Ahmed	BIH	7	JAMAK A. (BIH)			
	PAVARŠ Markuss	LAT	7	PAVARŠ M. (LAT)			
	MARLOV Alexander	SWE	8	MARLOV A. (SWE)	36	MARLOV A. (SWE)	00 s0 / 02 s0 [00:55]

POOL B

	BRIGMANIS-BRIGIS Ernests	LAT	9	BRIGMANIS-BRIGIS E. (LAT)			
	BECKER Georg	GER	10	BECKER G. (GER)	37	BECKER G. (GER)	00 s0 / 10 s0 [00:09]
	MIKONIS Dangiras	LTU	11	MIKONIS D. (LTU)			
	SOARES Isac	POR	12	SOARES I. (POR)	38	MIKONIS D. (LTU)	10 s0 / 00 s0 [01:24]
	JAPINS Raivis	LAT	13	JAPINS R. (LAT)			
	CERNIAVSKIJ Kiril	LTU	14	CERNIAVSKIJ K. (LTU)	39	CERNIAVSKIJ K. (LTU)	01 s0 / 10 s0 [03:03]
	RZEMIENIECKI Filip	POL	15	RZEMIENIECKI F. (POL)			
	SEIDELBERG Marten	EST	15	SEIDELBERG M. (EST)	40	ZVANERS D. (LAT)	10 s0 / 00 s0 [01:08]
	ZVANERS Daniels	LAT	16	ZVANERS D. (LAT)			

POOL C

	KULLO Tits	LAT	17	KULLO T. (LAT)			
	KOPONEN Ohto	FIN	18	KOPONEN O. (FIN)	41	KULLO T. (LAT)	10 s0 / 00 s1 [02:53]
	RAUSKA Davis	LAT	19	RAUSKA D. (LAT)			
	ZBYTNIIEWSKI Aleksander	POL	20	ZBYTNIIEWSKI A. (POL)	42	ZBYTNIIEWSKI A. (POL)	00 s1 / 02 s0 [00:46]
	ADATINS Sergejs	LAT	21	ADATINS S. (LAT)			
	JAKAS Eimantas	LTU	22	JAKAS E. (LTU)	43	JAKAS E. (LTU)	01 s0 / 10 s0 [02:32]
	BURMEISTER Luis	GER	23	BURMEISTER L. (GER)			
	LUNDBERG Vincent	SWE	23	LUNDBERG V. (SWE)	44	LUNDBERG V. (SWE)	00 s1 / 01 s2 [04:11]
	OTSMANN Ats	EST	24	OTSMANN A. (EST)			

POOL D

	PURPISS Nikass	LAT	25	PURPISS N. (LAT)			
	VINGISAAR Kristjan	EST	26	VINGISAAR K. (EST)	45	PURPISS N. (LAT)	02 s0 / 00 s0 [01:28]
	BORZECKI Jakub	POL	27	BORZECKI J. (POL)			
	STEPINS Valters	LAT	28	STEPINS V. (LAT)	46	BORZECKI J. (POL)	10 s0 / 00 s1 [04:34]
	HAJIYEV Ali	SWE	29	HAJIYEV A. (SWE)			
	CELADINS Nikita	LAT	30	CELADINS N. (LAT)	47	HAJIYEV A. (SWE)	02 s0 / 00 s0 [01:26]
	BRUECKNER Hannes	GER	31	BRUECKNER H. (GER)			
	STANKEVICIUS Ignas	LTU	32	STANKEVICIUS I. (LTU)	48	STANKEVICIUS I. (LTU)	00 s1 / 01 s1 [04:00]

REPECHAGE

	PAVARŠ M. (LAT)	61	PAVARŠ M. (LAT)				
			GUDEJEVS A. (LAT)	65	GUDEJEVS A. (LAT)		
			BASMAKOVŠ I. (LAT)	69	GUDEJEVS A. (LAT)		
	RZEMIENIECKI F. (POL)	62	RZEMIENIECKI F. (POL)				
			CERNIAVSKIJ K. (LTU)	66	RZEMIENIECKI F. (POL)		
			BECKER G. (GER)	70	BECKER G. (GER)		
	KOPONEN O. (FIN)	63	KOPONEN O. (FIN)				
			ZBYTNIIEWSKI A. (POL)	67	ZBYTNIIEWSKI A. (POL)		
			LUNDBERG V. (SWE)	71	ZBYTNIIEWSKI A. (POL)		
	STEPINS V. (LAT)	64	STEPINS V. (LAT)				
			PURPISS N. (LAT)	68	STEPINS V. (LAT)		
			STANKEVICIUS I. (LTU)	72	STANKEVICIUS I. (LTU)		

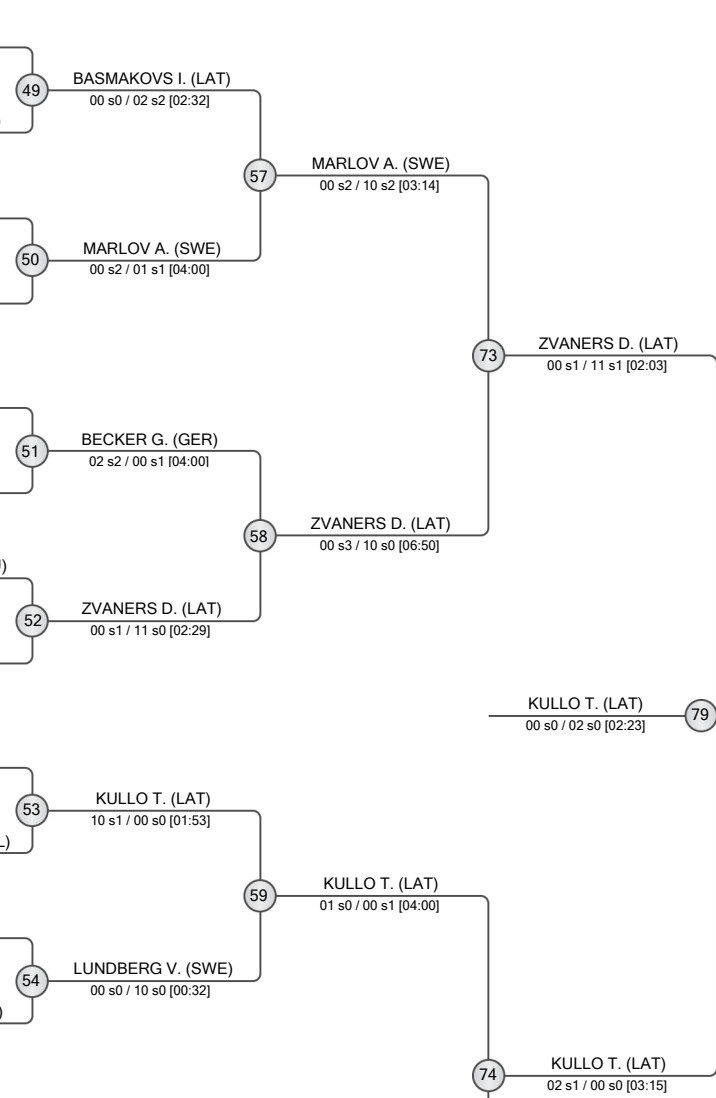

FINAL RESULTS		
1.	KULLO Tits	LAT
2.	ZVANERS Daniels	LAT
3.	GUDEJEVS Arsenijs	LAT
3.	MARLOV Alexander	SWE
5.	BORZECKI Jakub	POL
5.	ZBYTNIIEWSKI Aleksander	POL
7.	BECKER Georg	GER
7.	STANKEVICIUS Ignas	LTU



Riga Cadet European Cup 2024

Latvia, Riga, 19-20 Oct 2024

-81 kg

Men (24)

POOL A

	BABAICENKO Tajus	LTU
	AVDEJEVS Aleksandrs	LAT
	VITAL Frederico	POR
	GOLTZ Jerome	GER
	LOSANS Arnolds	LAT
	TRUUVERK Huud-Keerit	EST

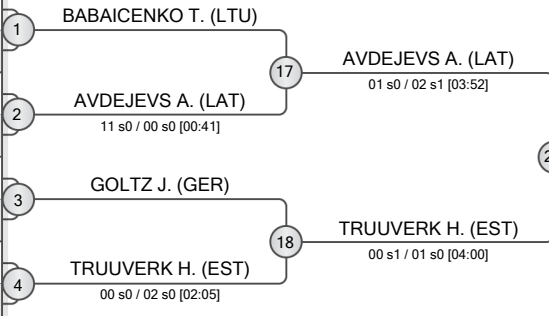

POOL B

	DURDEVIC Adrian	BIH
	INNO Oliver	EST
	VJAZEMSKIS Aigars	LAT
	ZARINS Ricards	LAT
	BOJANOWSKI Michal	POL
	PERELIGINS Arturs	LAT

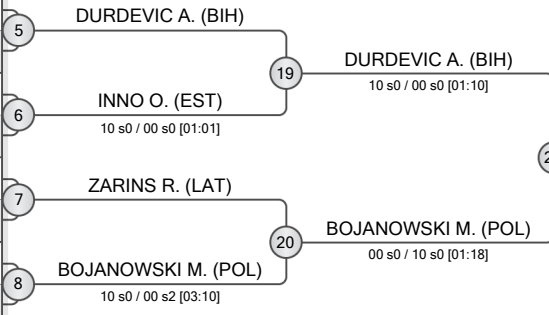

POOL C

	JACENKO Arturs	LAT
	SOLHAUG Fredrik Holm	NOR
	LEETSAR Kaur	EST
	BETKOWSKI Jeremiasz	POL
	KOLOSOVS Dmitrijs	LAT
	KIKAS Aleksei	EST

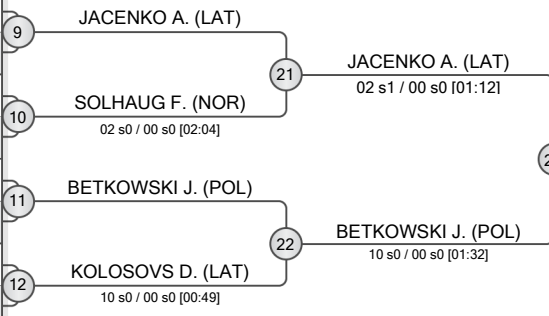

POOL D

	BUMAZKINS Jelisejs	LAT
	MARTINI Nicolas	GER
	BAKRADZE Oskar	EST
	POPOVS Maksims	LAT
	ZALEVSKIS Fjodors	LAT
	MATTSSON Wilmer	SWE

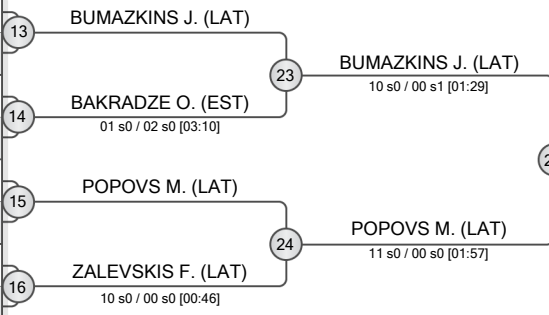

REPECHAGE

VITAL F. (POR)	(29) BABAICENKO T. (LTU) [00 s0 / 10 s0 [00:23]]	(33) BABAICENKO T. (LTU) [10 s0 / 00 s0 [00:20]]
BABAICENKO T. (LTU)	(30) ZARINS R. (LAT) [00 s0 / 11 s0 [01:08]]	(34) ZARINS R. (LAT) [10 s0 / 00 s0 [00:00]]
PERELIGINS A. (LAT)	(31) SOLHAUG F. (NOR)	(35) BETKOWSKI J. (POL) [00 s1 / 10 s1 [01:50]]
ZARINS R. (LAT)	(32) BAKRADZE O. (EST)	(36) POPOVS M. (LAT) [00 s0 / 11 s0 [01:02]]
SOLHAUG F. (NOR)		
SOLHAUG F. (NOR)		
BAKRADZE O. (EST)		

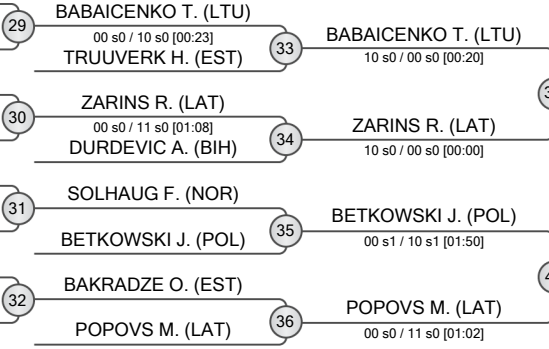

FINAL RESULTS	
1.	AVDEJEVS Aleksandrs LAT
2.	BUMAZKINS Jelisejs LAT
3.	BABAICENKO Tajus LTU
3.	POPOVS Maksims LAT
5.	JACENKO Arturs LAT
7.	BOJANOWSKI Michal POL
7.	ZARINS Ricards LAT
7.	BETKOWSKI Jeremiasz POL





Riga Cadet European Cup 2024

Latvia, Riga, 19-20 Oct 2024

-90 kg

Men (17)

POOL A

	MANFELDS Tomass	LAT
	ZILYS Tomas	LTU
	KOMIN Kirill	EST
	PASZEK Damian	POL

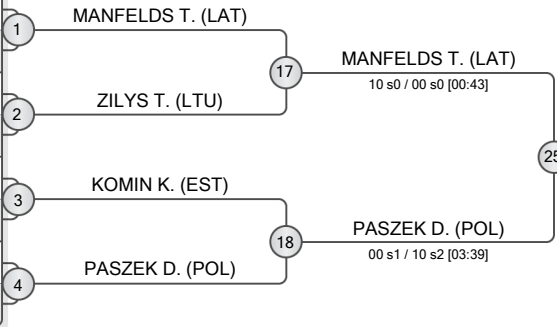

POOL B

	ANTHONI Oliver	FIN
	PICANCO Goncalo	POR
	NILLER Jaan	EST
	LIAUGAUDAS Matas	LTU

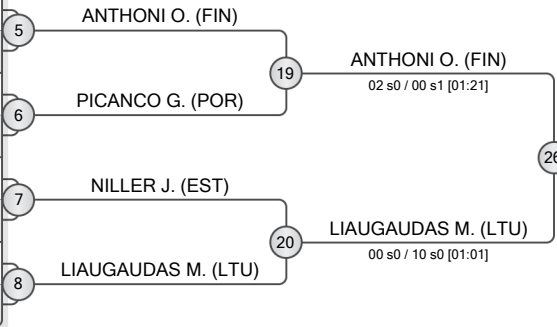

POOL C

	GENYS Majus	LTU
	WOJCIK Patryk	POL
	SUNDBY Marius	NOR
	JURGENSON Samuel	EST
	NACISCIONIS Nedas	LTU

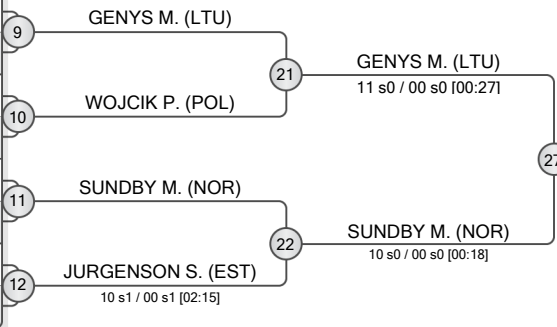

POOL D

	PETRAUSKAS Majus	LTU
	RUDI Lennox	GER
	KOORT Ken-Kermo	EST
	LAMBACKA Perttu	FIN

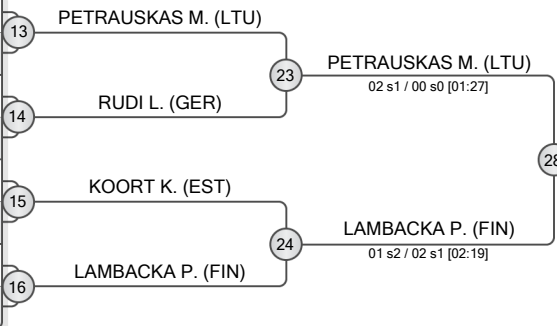

REPECHAGE

ZILYS T. (LTU)	29	ZILYS T. (LTU)	33
NILLER J. (EST)	30	NILLER J. (EST)	34
WOJCIK P. (POL)	31	SUNDBY M. (NOR)	35
RUDI L. (GER)	32	RUDI L. (GER)	36

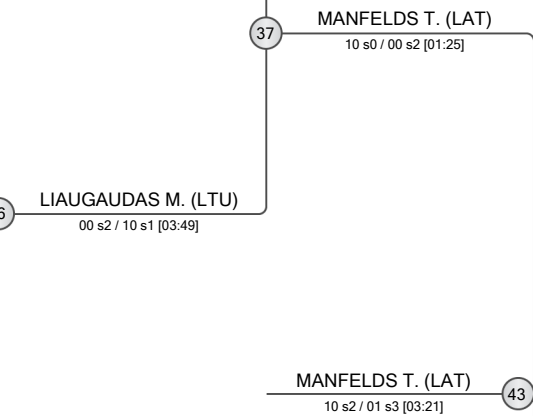
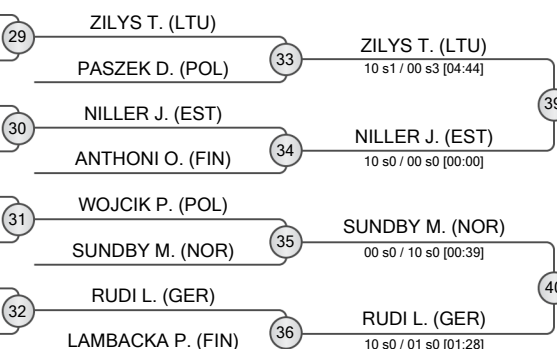

FINAL RESULTS	
1. MANFELDS Tomass	LAT
2. GENYS Majus	LTU
3. PETRAUSKAS Majus	LTU
3. LIAUGAUDAS Matas	LTU
5. ZILYS Tomas	LTU
5. RUDI Lennox	GER
7. NILLER Jaan	EST
7. SUNDBY Marius	NOR





Riga Cadet European Cup 2024

Latvia, Riga, 19-20 Oct 2024

+ 90 kg

Men (12)

POOL A

	MASAK Marek-Adrian	EST
	SAMUILAU Ivan	POL
	AFANASJEVS Nikita	LAT

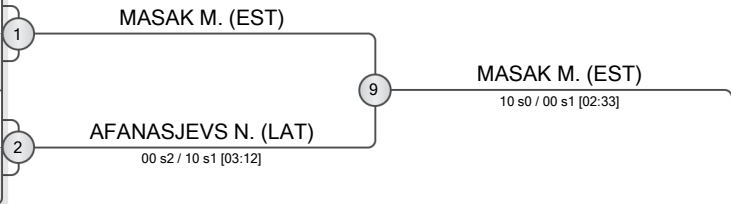

POOL B

	STIVENSON Arthur	CAN
	BLAZEVICIS Artemijs	LAT
	MASTEIKA Titas	LTU

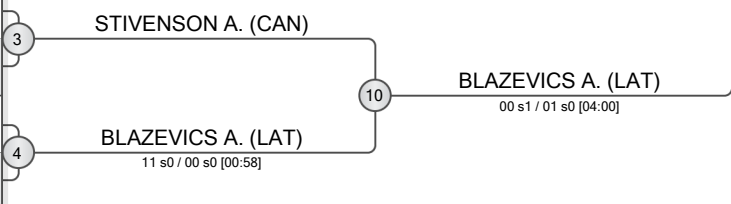

POOL C

	KHACHATRYAN Anton	POL
	APSALONS Aleksandrs	LAT
	PALEICIKAS Nikolas	LTU

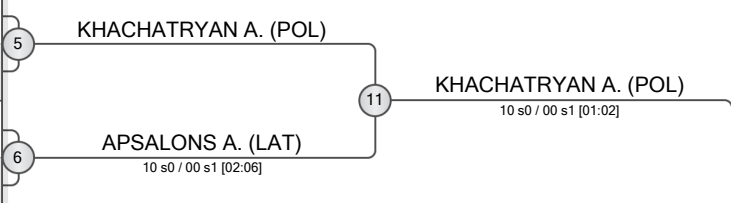

POOL D

	TAURA Patrikas	LTU
	NESTEROVS Vadims	LAT
	NARVA Miska	FIN

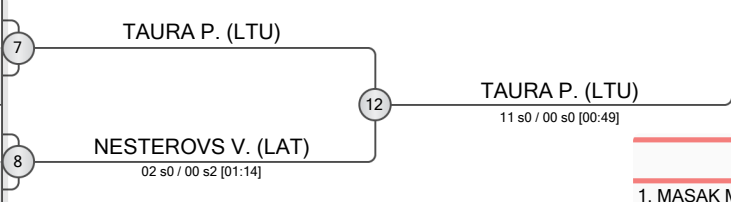

FINAL RESULTS		
1.	MASAK Marek-Adrian	EST
2.	KHACHATRYAN Anton	POL
3.	AFANASJEVS Nikita	LAT
3.	BLAZEVICIS Artemijs	LAT
5.	TAURA Patrikas	LTU
5.	APSALONS Aleksandrs	LAT
7.	MASTEIKA Titas	LTU
7.	NESTEROVS Vadims	LAT

REPECHAGE

AFANASJEVS N. (LAT)	13
MASTEIKA T. (LTU)	14
STIVENSON A. (CAN)	14
APSALONS A. (LAT)	15
NESTEROVS V. (LAT)	16

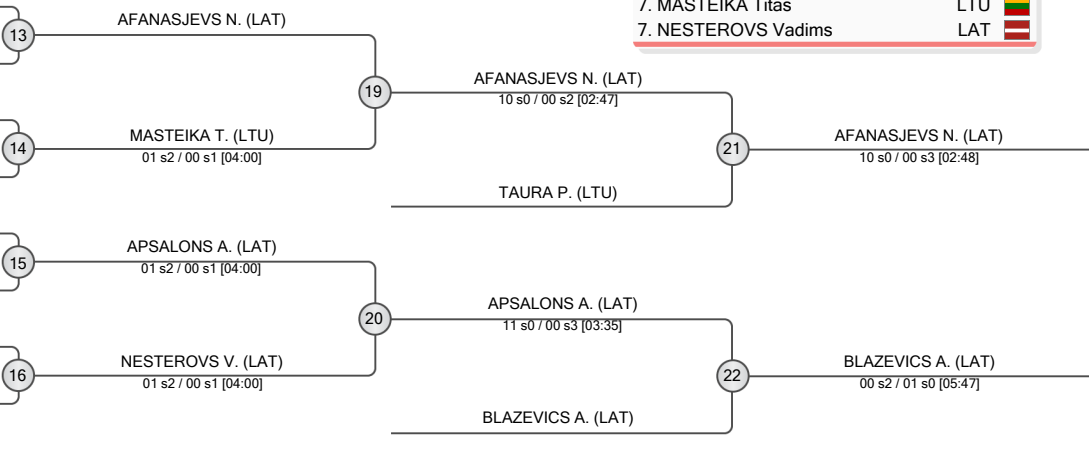



Riga Cadet European Cup 2024

Latvia, Riga, 19-20 Oct 2024

-44 kg

Women (7)

POOL A

WALENDZIK Sandra POL

WALENDZIK S. (POL)

POOL B

AZARUMYAN Anna EST
 PUOMILAHTI Iida FIN

AZARUMYAN A. (EST)

02 s0 / 00 s0 [01:54]

POOL C

LUKOSHEVSKA Nadia LTU
 LAVRINJOVA Marija EST

LAVRINJOVA M. (EST)

00 s0 / 01 s0 [04:00]

POOL D

BLASZCZYK Julia POL
 GASHI Blerina KOS

GASHI B. (KOS)

00 s1 / 02 s0 [02:14]

WALENDZIK S. (POL)

02 s0 / 00 s0 [02:53]

GASHI B. (KOS)

00 s0 / 01 s1 [04:00]

GASHI B. (KOS)

00 s0 / 02 s0 [00:49]

FINAL RESULTS

1. GASHI Blerina	KOS	
2. WALENDZIK Sandra	POL	
3. LAVRINJOVA Marija	EST	
3. AZARUMYAN Anna	EST	
5. PUOMILAHTI Iida	FIN	
5. BLASZCZYK Julia	POL	

REPECHAGE

PUOMILAHTI I. (FIN)

PUOMILAHTI I. (FIN)

LUKOSHEVSKA N. (LTU)
 BLASZCZYK J. (POL)

BLASZCZYK J. (POL)

00 s0 / 02 s0 [01:18]

PUOMILAHTI I. (FIN)
 LAVRINJOVA M. (EST)

LAVRINJOVA M. (EST)

LAVRINJOVA M. (EST)

00 s0 / 10 s0 [01:22]

AZARUMYAN A. (EST)

00 s0 / 10 s0 [01:22]





Riga Cadet European Cup 2024

Latvia, Riga, 19-20 Oct 2024

-48 kg

Women (13)

POOL A

	TWAROWSKA Barbara	POL
	LAVROVA Delija	LAT
	ARTEAGA Evelin	SWE

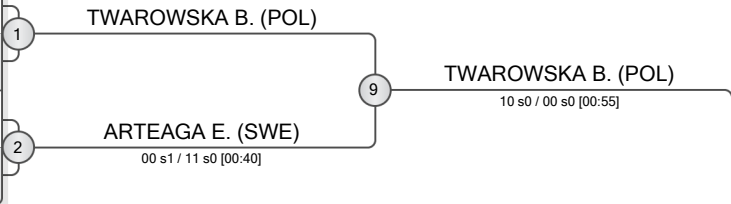

POOL B

	CHRISP Taylor	GBR
	MANTYKENTTA Sara	FIN
	FARIAS Isabel	POR
	PODYMSKA Nina	POL

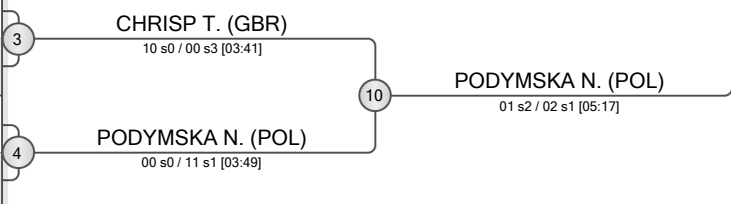

POOL C

	HERTA Gabriela	MDA
	LAPS Martyna	POL
	PETERSON Elsa	SWE

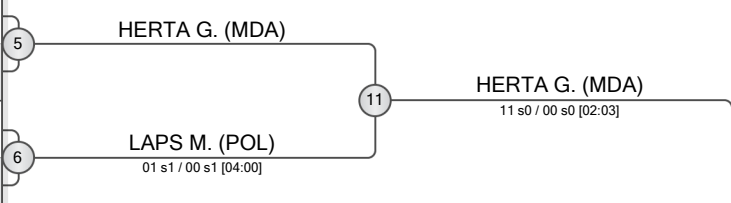

POOL D

	BROVOLD Selma	NOR
	CZERWINSKA-KOWAR Roksana	POL
	PISONI Alina	ITA

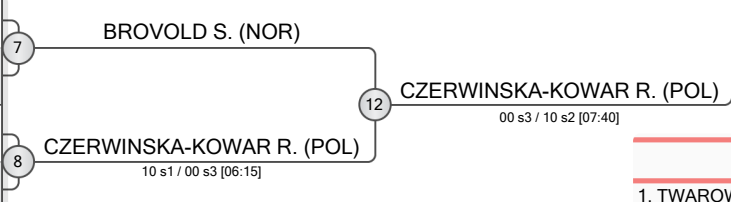

REPECHAGE

13	ARTEAGA E. (SWE)
14	CHRISP T. (GBR)
15	LAPS M. (POL)
16	BROVOLD S. (NOR)

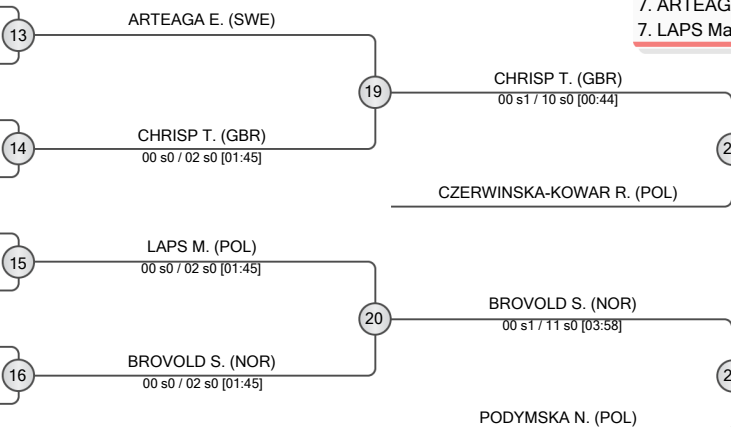

FINAL RESULTS		
1.	TWAROWSKA Barbara	POL
2.	HERTA Gabriela	MDA
3.	CHRISP Taylor	GBR
5.	CZERWINSKA-KOWAR Roksana	POL
5.	BROVOLD Selma	NOR
7.	ARTEAGA Evelin	SWE
7.	LAPS Martyna	POL





Riga Cadet European Cup 2024

Latvia, Riga, 19-20 Oct 2024

-52 kg

Women (13)

POOL A

	ROBINSON Lucy	GBR
	KAZACENKO Evelina	LAT
	ZARUBA Viktorija	LTU

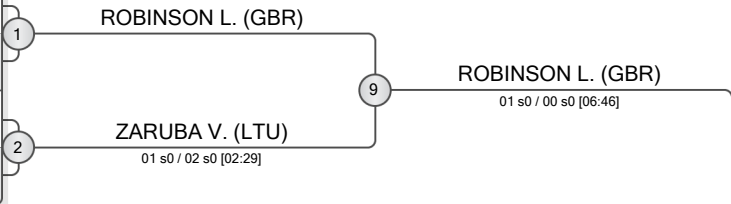

POOL B

	VADOVICOVA Vivien	SVK
	KARNA Olivia	FIN
	GOULART Vitoria	POR
	GRZESZCZYK Otylia	POL

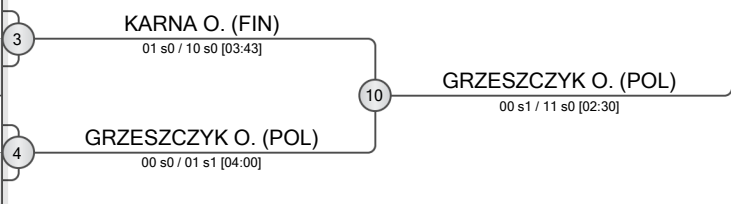

POOL C

	CORDOVA Sofia	SWE
	BARFOOT-SAUNT Olivia	GBR
	GREGOR Stefanie	GER

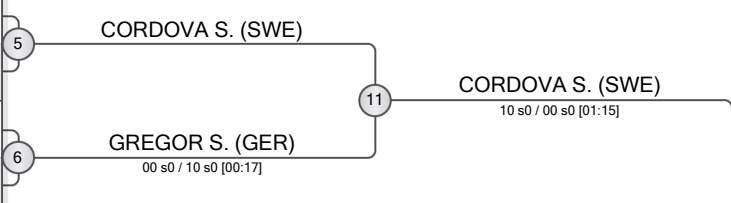

POOL D

	MOS Marika	POL
	TAIT Angelica	ITA
	ZUCIKA Ksenija	LAT

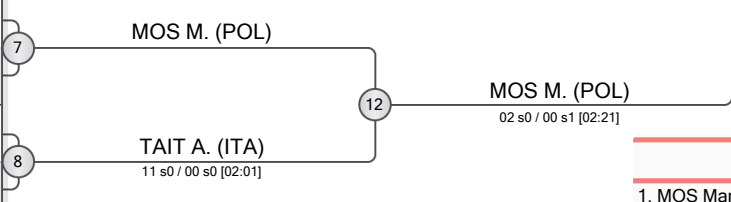

FINAL RESULTS		
1.	MOS Marika	POL
2.	GRZESZCZYK Otylia	POL
3.	CORDOVA Sofia	SWE
3.	ROBINSON Lucy	GBR
5.	ZARUBA Viktorija	LTU
5.	TAIT Angelica	ITA
7.	KARNA Olivia	FIN
7.	GREGOR Stefanie	GER

REPECHAGE

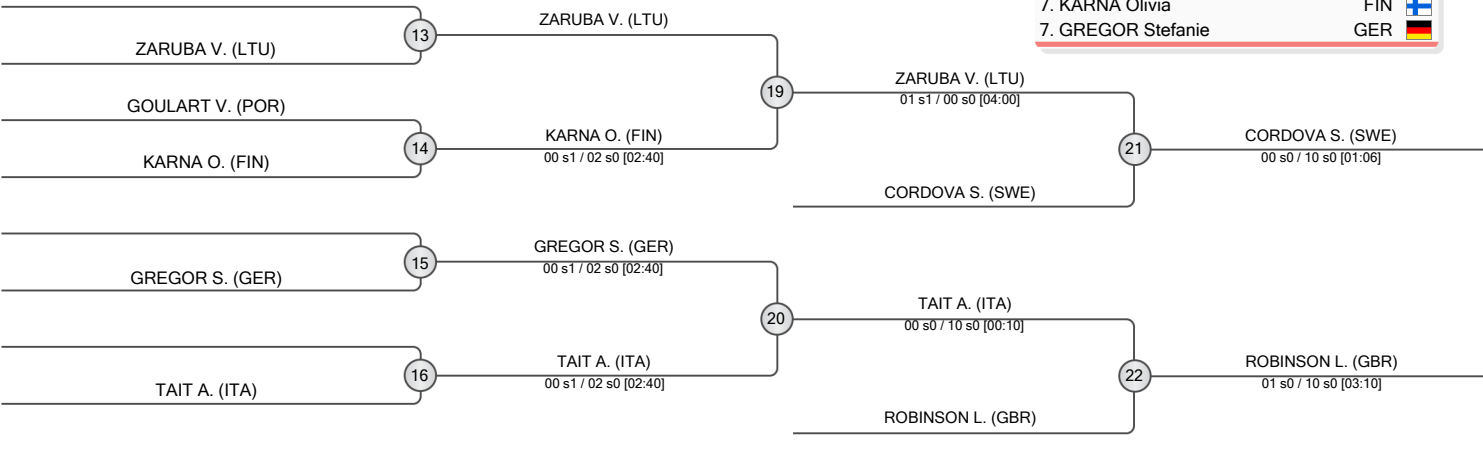



Riga Cadet European Cup 2024

Latvia, Riga, 19-20 Oct 2024

-57 kg

Women (20)

POOL A

	SKERYTE Ugne	LTU
	VATER Fiona	GER
	GANOVSKA Sofia	SVK
	PEKKI Sofia	FIN
	PETERSON Ebba	SWE

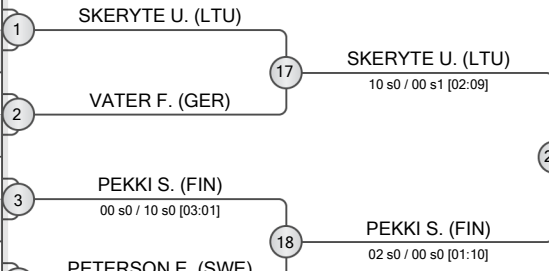

POOL B

	RASIMENOKA Marija	LAT
	GOTTSCHALK Mia Loreen	GER
	KERGALVE Viktorija	LAT
	BORCZ Blanka	POL
	MATIAS Ana	POR

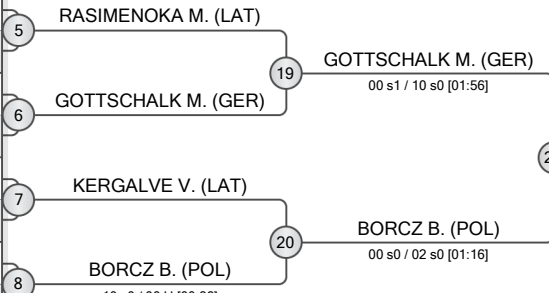

POOL C

	WALEGA Magdalena	POL
	AUBERT GOMEZ Maya	GBR
	TRAAVIK Asal	NOR
	PLATHE Hanna	GER
	KARJALAINEN Eila	FIN

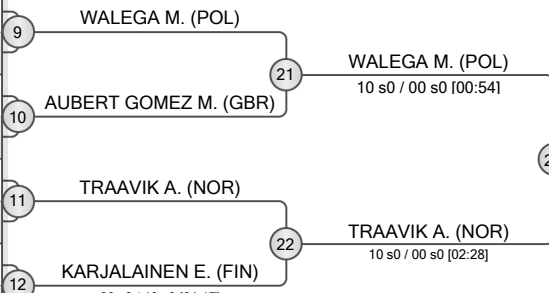

POOL D

	LAPPETELAINEN Essi	FIN
	CESLAUSKAITE Deimante	LTU
	BABULFATH Hanna	SWE
	SIEMKO Julia	POL
	KOAR Lindsay Maria	GER

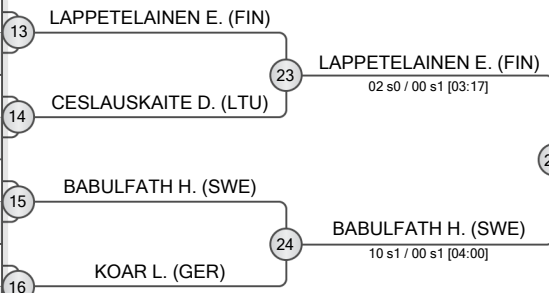

REPECHAGE

VATER F. (GER)	29	VATER F. (GER)	33	PEKKI S. (FIN)
RASIMENOKA M. (LAT)	30	RASIMENOKA M. (LAT)	34	BORCZ B. (POL)
AUBERT GOMEZ M. (GBR)	31	AUBERT GOMEZ M. (GBR)	35	AUBERT GOMEZ M. (GBR)
CESLAUSKAITE D. (LTU)	32	CESLAUSKAITE D. (LTU)	36	BABULFATH H. (SWE)

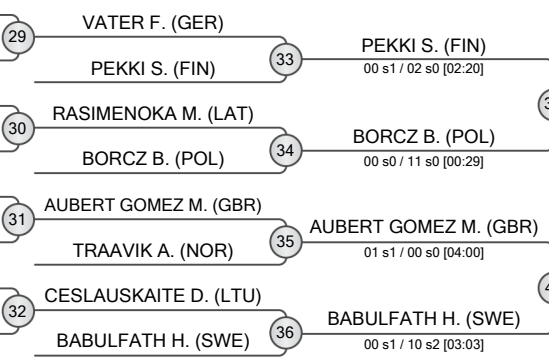

WALEGA M. (POL) [43]

WALEGA M. (POL) [38]

FINAL RESULTS	
1. WALEGA Magdalena	POL
2. SKERYTE Ugne	LTU
3. PEKKI Sofia	FIN
3. BABULFATH Hanna	SWE
5. LAPPETELAINEN Essi	FIN
5. GOTTSCHALK Mia Loreen	GER
7. BORCZ Blanka	POL
7. AUBERT GOMEZ Maya	GBR





Riga Cadet European Cup 2024

Latvia, Riga, 19-20 Oct 2024

-63 kg

Women (16)

POOL A

	DALMASSO Madeleine	FRA
	CIESZYNSKA Oliwia	POL
	SEMOUD Luna	GER
	THOMSON Maia	CAN

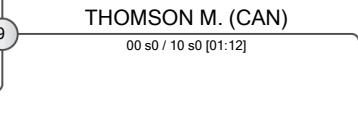
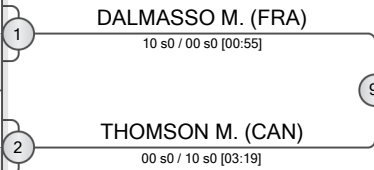

POOL B

	WOZNICZKO Nadia	POL
	KONNAPER E. Emma Karoliina	EST
	HASNASA Olga	LAT
	WITGREN Wilda	SWE

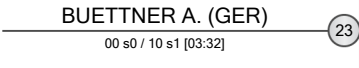
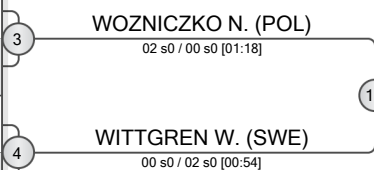

POOL C

	RAGAUŠKAITE Viktorija	LTU
	GRAMBO Anna	NOR
	KUTKEVICA Sofija	LAT
	DUDA Julia	POL

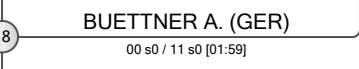
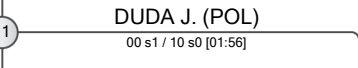
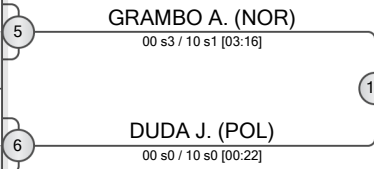

POOL D

	TATAJ Julia	POL
	KORDEL Mira	SWE
	MACOVEI Laura	POR
	BUETTNER Alesia	GER

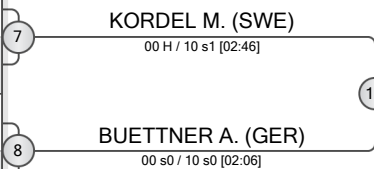

FINAL RESULTS		
1.	BUETTNER Alesia	GER
2.	WOZNICZKO Nadia	POL
3.	DALMASSO Madeleine	FRA
3.	THOMSON Maia	CAN
5.	DUDA Julia	POL
5.	KORDEL Mira	SWE
7.	WITGREN Wilda	SWE
7.	GRAMBO Anna	NOR

REPECHAGE

SEMOUD L. (GER)	13
DALMASSO M. (FRA)	14
KONNAPER E. (EST)	15
WITGREN W. (SWE)	16
KUTKEVICA S. (LAT)	17
GRAMBO A. (NOR)	18
MACOVEI L. (POR)	19
KORDEL M. (SWE)	20

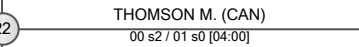
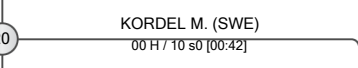
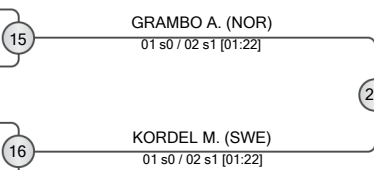
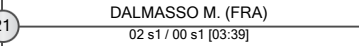
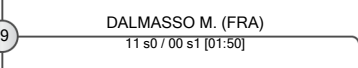
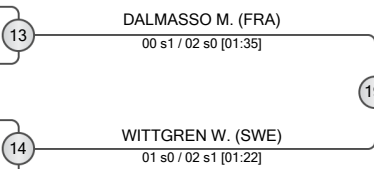



Riga Cadet European Cup 2024

Latvia, Riga, 19-20 Oct 2024

-70 kg

Women (10)

POOL A

	ISAJEVA Anastasija	LAT
	ZYS Roksana	POL

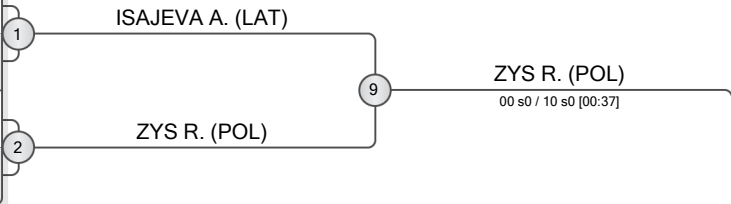

POOL B

	BENKOVA Diana	POL
	JOHANSSON Ronja	SWE
	POGOSYAN Gayane	EST

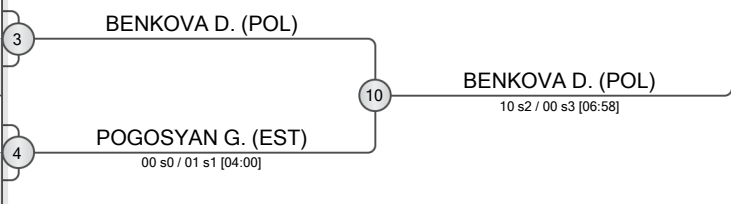

POOL C

	STALIONYTE Paulina	LTU
	OLSZEWSKA Kinga	POL

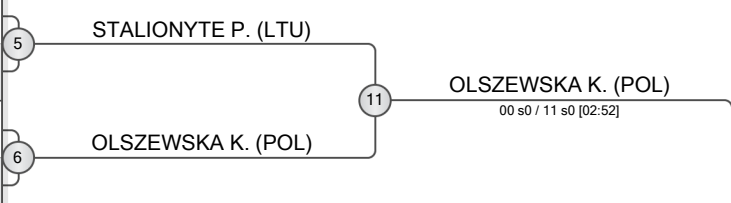

POOL D

	STRAK Oliwia	POL
	ARUKAEVU Getter	EST
	LATKOWSKI Antonia	GER

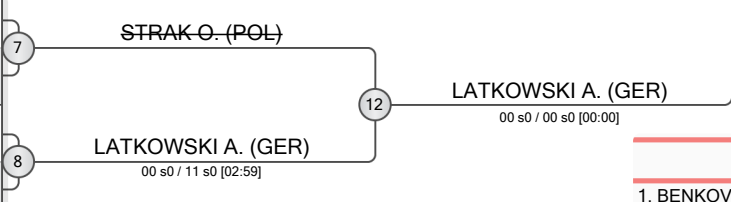

REPECHAGE

ISAJEVA A. (LAT)	13
POGOSYAN G. (EST)	14
STALIONYTE P. (LTU)	15
ARUKAEVU G. (EST)	16

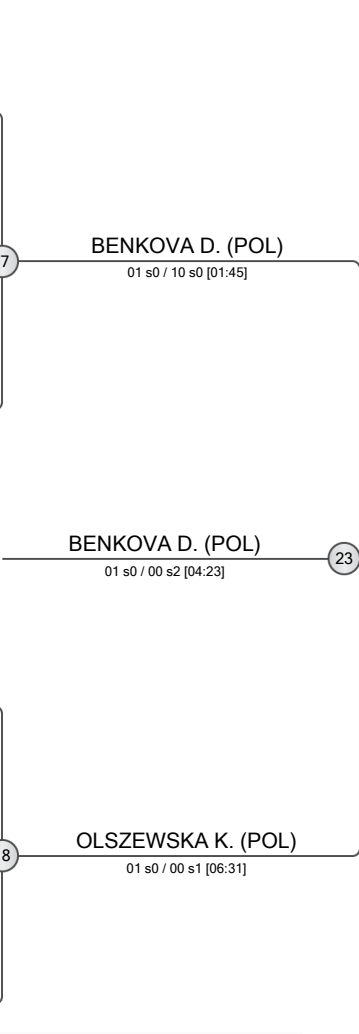
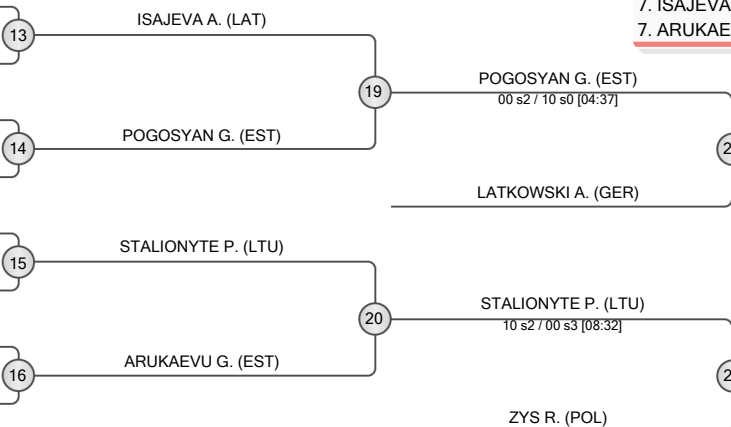

FINAL RESULTS		
1. BENKOVA Diana	POL	
2. OLSZEWSKA Kinga	POL	
3. POGOSYAN Gayane	EST	
3. ZYS Roksana	POL	
5. LATKOWSKI Antonia	GER	
5. STALIONYTE Paulina	LTU	
7. ISAJEVA Anastasija	LAT	
7. ARUKAEVU Getter	EST	





Riga Cadet European Cup 2024

Latvia, Riga, 19-20 Oct 2024

+ 70 kg

Women (5)

Num.	Competitor	State	1	3	5	Wins	Points
1.	ZAREBA Nikola	Poland		10	10	2	20
3.	EININGE Saule	Lithuania	0		10	2	20
5.	BUKOWSKA Maria	Poland	0	0		0	0

Num.	Competitor	State	2	4	Wins	Points
2.	TROKA Julia	Poland		10	1	10
4.	TALVET Iti	Estonia	0		0	0

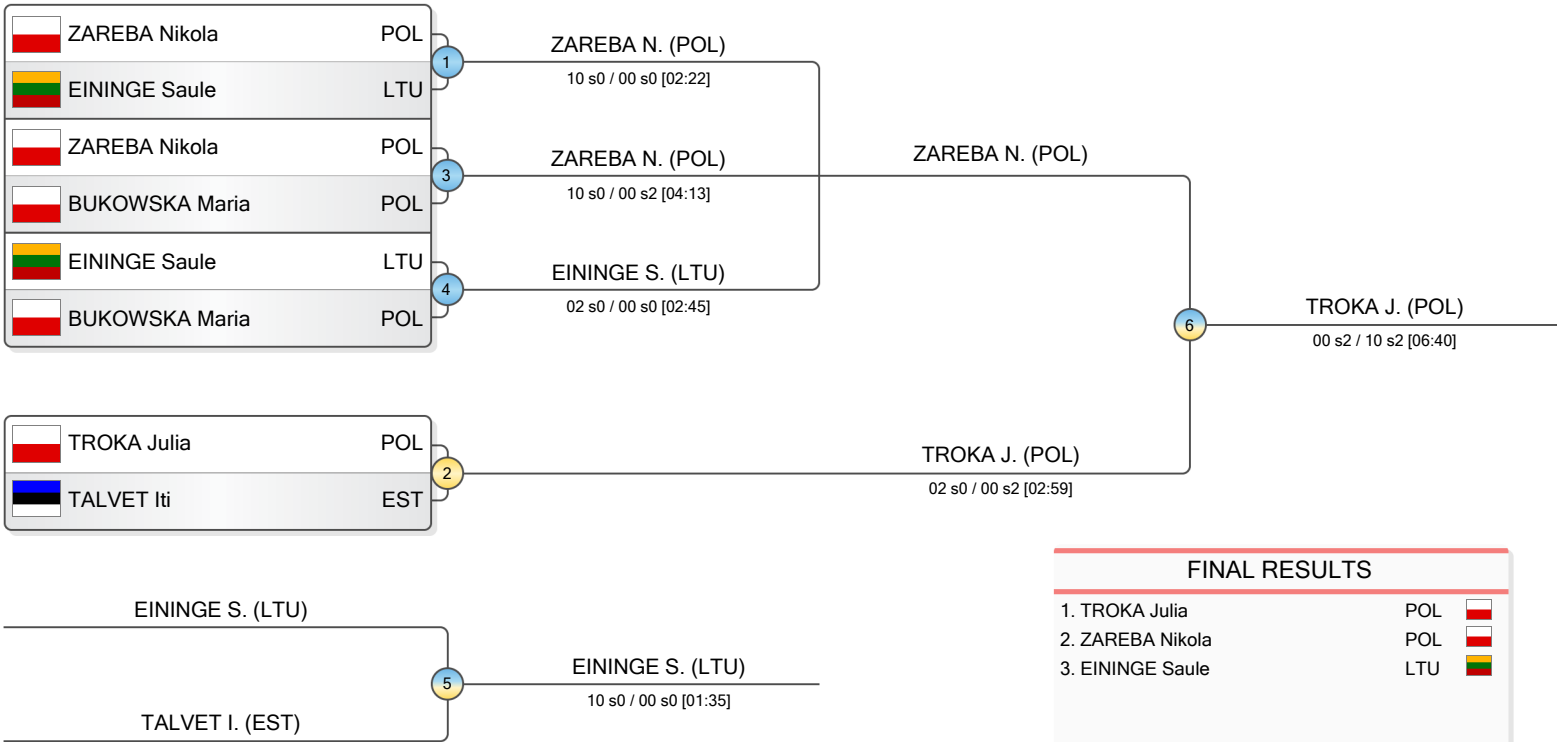

FINAL RESULTS		
1.	TROKA Julia	POL
2.	ZAREBA Nikola	POL
3.	EININGE Saule	LTU

