

563 competitors from 27 nations

363 Men

200 Women

64.48%

35.52%

-50 kg	-55 kg	-60 kg	-66 kg	-73 kg	-81 kg	-90 kg	+90 kg	Men
24	31	61	65	68	65	29	20	363









-40 kg	-44 kg	-48 kg	-52 kg	-57 kg	-63 kg	-70 kg	+70 kg	Women
2	11	24	31	46	43	29	14	200

Continent	AJU	JUA	EJU	OJU	PJC	Total
Nations		1	24	1	1	27
Competitors		2	550	10	1	563

Schedule		
Date	9 Nov	10 Nov
Start	09:00	09:00
End	16:00	17:00
Finals start	16:00	17:00
Finals end	18:30	19:30

-50 kg		
1	SZABO Milan	HUN 
2	MARTINOV Tsvetelin	BUL 
3	BOLKVADZE Saba	GEO 
3	DUFRAIGNE Mathis	FRA 
5	PENEZ Enzo	FRA 
5	DAMM Oliver	HUN 
7	DOBROWOLSKI Bartlomiej	POL 
7	GART Lidor	ISR 





-55 kg		
1	ORUJOV Bayram	AZE 
2	MILOSEVIC Aleksa	SRB 
3	ZINCHUK Maksym	UKR 
3	GIVISHVILI Nikoloz	GEO 
5	GOLDMAN Gilad	ISR 
5	GALENKOV Ivo	BUL 
7	MATVIICHUK Vladyslav	UKR 
7	KOSTOEV Adam	SWE 



-60 kg		
1	HEYDAROV Khazar	UKR 
2	TCHIBERASHVILI Vakhtangi	GEO 
3	MUNIZ ACOSTA Jakub	POL 
3	GALO Bence	HUN 
5	FRIDMAN Maor	ISR 
5	BASOV Renat	UKR 
7	MICHALAK Wojciech	POL 
7	NAGY Aron	HUN 

-66 kg		
1	MARTYNCHUK Oleksandr	UKR 
2	NAZARENKO Illia	UKR 
3	ODKLADAL Juraj	SVK 
3	OSTAPENKO Bohdan	UKR 
5	ABBASOV Yusif	AZE 
5	STOEGMANN Stefan	AUT 
7	HADZI-VELJKOVIC Nikola	CRO 
7	NARKUS Girvydas	LTU 

-73 kg		
1	KISS Szabolcs	HUN 
2	MILJIC Sinisa	SRB 
3	ADORJANI Andras	HUN 
3	RUDENKO Tymofii	UKR 
5	DIMITROV Ivo	BUL 
5	MARLOV Alexander	SWE 
7	MAKHASHEV Elbert	AUT 
7	BORZECKI Jakub	POL 









-81 kg		
1	KARAKIN Serhii	UKR 
2	VITKOVIĆ Andrej	SRB 
3	GORUN Volodymyr	UKR 
3	HARMASH Ivan	UKR 
5	HALICH Dmytro	UKR 
5	GUSIC Imran	BIH 
7	TOLGYESI Bende	HUN 
7	BABAICENKO Tajus	LTU 





-90 kg		
1	GENYS Majus	LTU 
2	SIMIC Nemanja	SRB 
3	ALIYEV Janpolad	AZE 
3	SAMOILOV Arkadii	UKR 
5	OBRADOVIC Nikola	SRB 
5	MAKARENKO Artur	UKR 
7	BILOUS Illia	UKR 
7	PASZEK Damian	POL 







+90 kg		
1	SZEKERES Abel	HUN 
2	LUBURA Nikola	BIH 
3	ABALAKI Ioane	GEO 
3	CSERMAK Daniel	HUN 
5	CORKOVIC Filip	SRB 
5	MASIMOV Javidan	AZE 
7	STIVENSON Arthur	CAN 
7	ANGERER Lukas	AUT 

-40 kg		
1	PIRBUS-GROF Nora	HUN 









-44 kg		
1	WALENDZIK Sandra	POL 
2	SERBAN Denisa	ROU 
3	PAPAI Stella	HUN 
3	TANACKOV Marija	SRB 
5	BLASZCZYK Julia	POL 
5	KUNYIK Laura-Sophie	AUT 
7	NOSENKO Yelyzaveta	UKR 
7	DUBLJEVIC Ivana	SRB 









-48 kg		
1	HIROSE Rika	AUS 
2	KRIZOVA Kristina Lili	SVK 
3	KISS Viktoria	HUN 
3	TUCAJ Martina	CRO 
5	PEREIRA Mariana	POR 
5	PODYMSKA Nina	POL 
7	MAYRHOFER Lena	AUT 
7	CULJAK Petra	BIH 





















-52 kg		
1	VAS Mira	HUN 
2	SZABO Reka	HUN 
3	MOS Marika	POL 
3	HARANI Talya	ISR 
5	CORDOVA Sofia	SWE 
5	MOMOT Neonila	UKR 
7	MIKOTA Katharina	AUT 
7	BARISIC Laura	CRO 

-57 kg		
1	SEVERYN Anastasiia	UKR 
2	WALEGA Magdalena	POL 
3	VARADI Noemi	HUN 
3	VEINHANDL OBAID Haya	SLO 
5	JUTTNER Janka	HUN 
5	BOZSO Zita	HUN 
7	JANUSZ Urszula	POL 
7	SCHWARZBAUER Carina	AUT 

-63 kg		
1	WOZNICZKO Nadia	POL 
2	SAMOILIUK Diana	UKR 
3	PAVLOVIC Nevena	SRB 
3	SKILJEVIC Ana	BIH 
5	MATUSZEKOVA Paula	SVK 
5	ANDRIC Nina	SRB 
7	SCERBOVA Amalie	CZE 
7	ZIVANOVIC Tijana	SRB 

-70 kg		
1	RULLIER Lucie	FRA 
2	ZYS Roksana	POL 
3	MENANTEAU Jeanne	FRA 
3	USURELU Alexia	ROU 
5	WOGERER Selina	AUT 
5	SARKOZI Zsuzsa	HUN 
7	PAVIC Lucia	SRB 
7	MCHENRY Hannah	AUS 

+70 kg		
1	FEUILLET--NGUIMGO Emma	FRA 
2	TROKA Julia	POL 
3	HOELLWART Michaela	AUT 
3	FILKOROVA Nina	SVK 
5	ZAREBA Nikola	POL 
5	HEURTEAU Bleuene	FRA 
7	KOCIEBA Aleksandra	POL 
7	PODZEMNA Zuzana	CZE 

#	Nation		1. Place	2. Place	3. Place	5. Place	7. Place
1.		HUN Hungary	5	1	6	4	2
2.		UKR Ukraine	4	2	6	4	3
3.		POL Poland	2	3	2	3	6
4.		FRA France	2		2	2	
5.		AZE Azerbaijan	1		1	2	
6.		LTU Lithuania	1				2
7.		AUS Australia	1				1
8.		SRB Serbia		4	2	3	3
9.		GEO Georgia		1	3		
10.		SVK Slovakia		1	2	1	
11.		BIH Bosnia and Herzegovina		1	1	1	1
12.		ROU Romania		1	1		
13.		BUL Bulgaria		1		2	
14.		AUT Austria			1	3	5
15.		ISR Israel			1	2	1
16.		CRO Croatia			1		2
17.		SLO Slovenia			1		
18.		SWE Sweden				2	1
19.		POR Portugal				1	
20.		CZE Czechia					2
21.		CAN Canada					1

Official person:



Statistics

Gyor Cadet European Cup 2024, 9-10 Nov 2024

Statistics

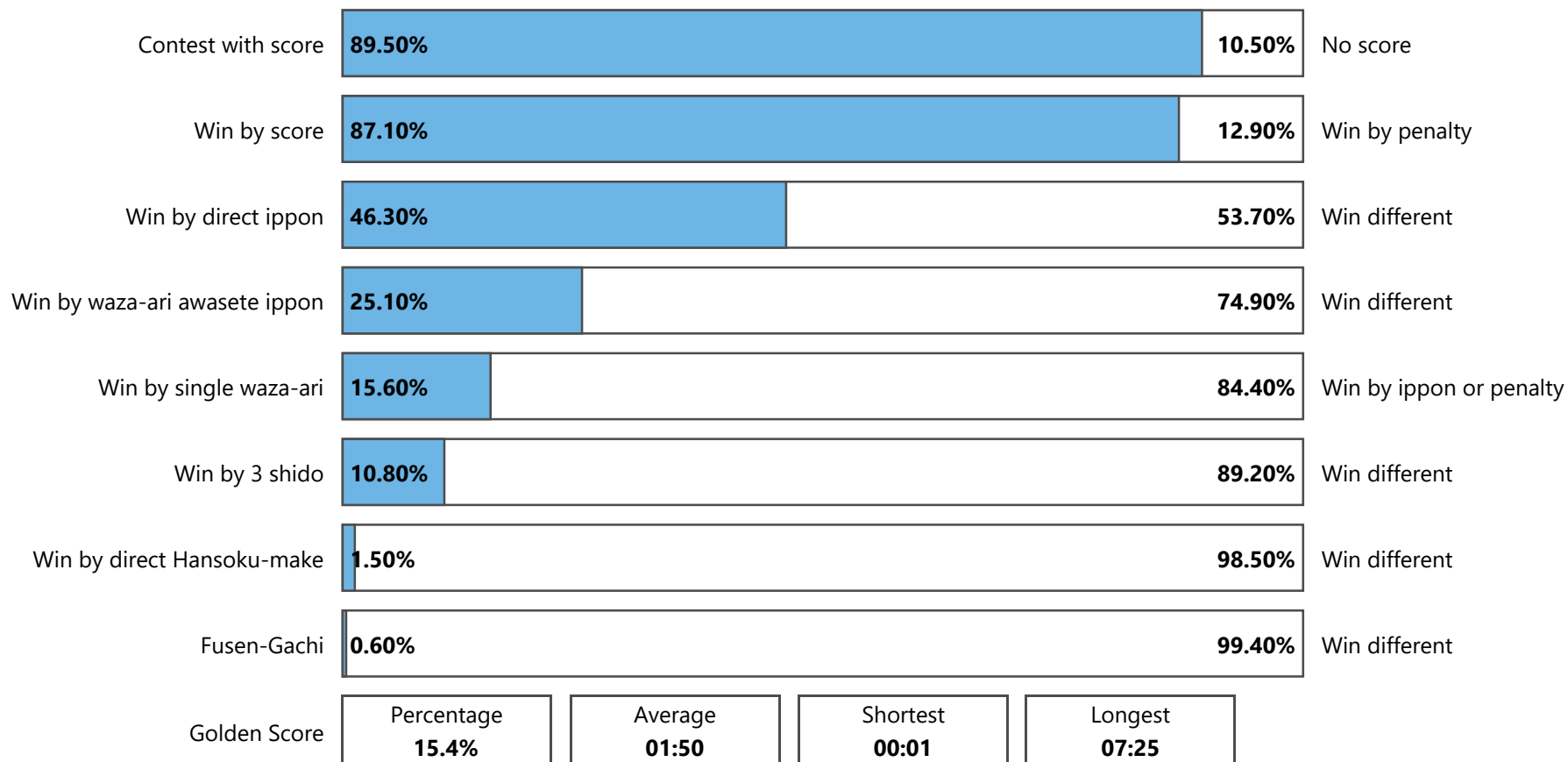





























Statistics

Gyor Cadet European Cup 2024, 9-10 Nov 2024

Statistics

	-50	-55	-60	-66	-73	-81	-90	+90	M	-40	-44	-48	-52	-57	-63	-70	+70	W	Total
Competitors	24	31	61	65	68	65	29	20	363	2	11	24	31	46	43	29	14	200	563
Contests	31	42	73	80	83	80	38	28	455	1	15	31	41	57	54	39	19	257	712
Contests with score	27	38	68	74	74	76	34	23	414	1	13	28	36	46	50	34	15	223	637
Contests with score %	87.1%	90.5%	93.2%	92.5%	89.2%	95%	89.5%	82.1%	91.0%	100%	86.7%	90.3%	87.8%	80.7%	92.6%	87.2%	78.9%	86.8%	89.5%
Wins by Score	27	38	66	72	70	74	33	22	402	1	13	28	35	44	50	32	15	218	620
Wins by Score %	87.1%	90.5%	90.4%	90%	84.3%	92.5%	86.8%	78.6%	88.4%	100%	86.7%	90.3%	85.4%	77.2%	92.6%	82.1%	78.9%	84.8%	87.1%
Wins by direct Ippon	14	21	31	44	41	39	22	12	224		8	12	15	19	27	15	10	106	330
Wins by direct Ippon %	45.2%	50%	42.5%	55%	49.4%	48.8%	57.9%	42.9%	49.2%	0%	53.3%	38.7%	36.6%	33.3%	50%	38.5%	52.6%	41.2%	46.3%
Wins by Waza-ari Awasete Ippon	7	10	22	15	17	19	9	7	106		3	9	11	20	17	11	2	73	179
Wins by Waza-ari Awasete Ippon %	22.6%	23.8%	30.1%	18.8%	20.5%	23.8%	23.7%	25%	23.3%	0%	20%	29%	26.8%	35.1%	31.5%	28.2%	10.5%	28.4%	25.1%
Wins by single Waza-ari	6	7	13	13	12	16	2	3	72	1	2	7	9	5	6	6	3	39	111
Wins by single Waza-ari %	19.4%	16.7%	17.8%	16.3%	14.5%	20%	5.3%	10.7%	15.8%	100%	13.3%	22.6%	22%	8.8%	11.1%	15.4%	15.8%	15.2%	15.6%
Wins by 3 Shido for opponent	4	4	5	7	12	4	4	5	45		2	3	5	9	4	6	3	32	77
Wins by 3 Shido for opponent %	12.9%	9.5%	6.8%	8.8%	14.5%	5%	10.5%	17.9%	9.9%	0%	13.3%	9.7%	12.2%	15.8%	7.4%	15.4%	15.8%	12.5%	10.8%
Direct Hansoku-make			2	1	1	2	1	1	8				1	1			1	3	11
Wins by direct Hansoku-make %	0%	0%	2.7%	1.3%	1.2%	2.5%	2.6%	3.6%	1.8%	0%	0%	0%	2.4%	1.8%	0%	0%	5.3%	1.2%	1.5%
Fusen-gachi														3		1		4	4
Fusen-gachi %	0%	0%	0%	0%	0%	0%	0%	0%	0%	0%	0%	0%	0%	5.3%	0%	2.6%	0%	1.6%	0.6%
All positive Scores (Waza-ari + direct Ippon)	41	53	112	104	117	112	49	33	621	1	20	44	54	76	80	56	21	352	973
Average Scores per contests	1.3	1.3	1.5	1.3	1.4	1.4	1.3	1.2	1.34	1	1.3	1.4	1.3	1.3	1.5	1.4	1.1	1.29	1.31
All penalties (Shido + HSK)	42	47	86	129	135	91	59	38	627	1	20	35	47	75	58	55	29	320	947
Average penalty per contest	1.4	1.1	1.2	1.6	1.6	1.1	1.6	1.4	1.38	1	1.3	1.1	1.1	1.3	1.1	1.4	1.5	1.22	1.3
Golden Score	3	5	12	13	10	12	5	3	63		3	6	8	11	11	4	4	47	110
Golden Score %	9.7%	11.9%	16.4%	16.3%	12%	15%	13.2%	10.7%	13.8%	0%	20%	19.4%	19.5%	19.3%	20.4%	10.3%	21.1%	18.3%	15.4%
Osae-komi																			
Osae-komi %	0%	0%	0%	0%	0%	0%	0%	0%	0%	0%	0%	0%	0%	0%	0%	0%	0%	0%	0%
Wins by Penalty	4	4	7	8	13	6	5	6	53		2	3	6	10	4	6	4	35	88

			-50	-55	-60	-66	-73	-81	-90	+90	M	-40	-44	-48	-52	-57	-63	-70	+70	W	Total	D
1.	 AUS	Australia	0	2	1	0	3	2	0	0	8	0	0	1	0	0	0	1	0	2	10	3
2.	 AUT	Austria	1	3	2	4	6	4	2	1	23	0	1	3	1	6	2	2	1	16	39	18
3.	 AZE	Azerbaijan	2	1	4	5	2	4	1	1	20	0	0	0	0	0	0	0	0	0	20	2
4.	 BIH	Bosnia and Herzegovina	0	0	1	3	3	2	0	2	11	0	0	1	0	0	1	1	0	3	14	5
5.	 BUL	Bulgaria	2	1	1	4	1	1	1	0	11	0	1	4	1	0	0	0	0	6	17	4
6.	 CAN	Canada	0	0	0	0	0	0	0	1	1	0	0	0	0	0	0	0	0	0	1	0
7.	 CRO	Croatia	0	2	3	2	2	2	0	1	12	0	0	2	2	3	2	2	0	11	23	7
8.	 CZE	Czechia	0	0	3	2	2	2	1	1	11	0	0	0	2	3	3	1	1	10	21	5
9.	 DEN	Denmark	0	0	1	1	0	0	0	0	2	0	0	0	1	0	1	1	0	3	5	1
10.	 FRA	France	2	0	1	0	0	0	0	0	3	0	0	1	0	1	0	2	2	6	9	7
11.	 GEO	Georgia	2	1	2	2	1	1	1	1	11	0	0	0	0	0	0	0	0	0	11	4
12.	 GRE	Greece	1	1	0	0	0	2	0	0	4	0	0	0	0	0	2	0	0	2	6	1
13.	 HUN	Hungary	4	2	9	10	9	10	9	5	58	2	1	3	5	8	5	7	1	32	90	42
14.	 ISR	Israel	2	3	10	6	2	3	2	0	28	0	1	0	2	4	5	0	0	12	40	9
15.	 ITA	Italy	1	0	0	0	0	2	0	0	3	0	0	0	0	1	1	0	0	2	5	5
16.	 KGZ	Kyrgyzstan	0	0	1	0	1	0	0	0	2	0	0	0	0	0	0	0	0	0	2	1
17.	 LAT	Latvia	0	0	0	0	0	1	0	0	1	0	0	0	0	0	0	0	0	0	1	0
18.	 LTU	Lithuania	2	0	1	4	3	2	2	1	15	0	0	0	2	0	1	1	1	5	20	3
19.	 MDA	Republic of Moldova	1	0	1	2	3	1	0	0	8	0	0	0	0	0	0	0	0	0	8	3
20.	 POL	Poland	1	3	4	5	6	2	2	0	23	0	2	1	3	4	4	2	3	19	42	15
21.	 POR	Portugal	0	0	0	0	0	0	0	0	0	0	0	1	0	1	0	0	0	2	2	2
22.	 ROU	Romania	1	2	3	1	4	3	1	1	16	0	1	1	4	4	5	5	1	21	37	7
23.	 SLO	Slovenia	0	0	0	0	0	0	0	0	0	0	0	0	0	1	0	1	0	2	2	2
24.	 SRB	Serbia	0	1	4	1	3	4	2	2	17	0	3	0	1	0	3	1	1	9	26	13
25.	 SVK	Slovakia	1	3	2	4	3	4	2	0	19	0	0	4	2	6	3	0	1	16	35	11
26.	 SWE	Sweden	0	1	0	1	4	1	0	0	7	0	0	1	1	1	2	1	0	6	13	5
27.	 UKR	Ukraine	1	5	7	8	10	12	3	3	49	0	1	1	4	3	3	1	2	15	64	9
			24	31	61	65	68	65	29	20	363	2	11	24	31	46	43	29	14	200	563	184



Gyor Cadet European Cup 2024

Hungary, Gyor, 9-10 Nov 2024

-50 kg

Men (24)

POOL A

	MARTINOV Tsvetelin	BUL
	CZINEGE David	HUN
	DALOIA Antonio	ITA
	BOLKVDZDE Saba	GEO
	VICOL Gabriel	MDA
	BELIK Vadim	LTU

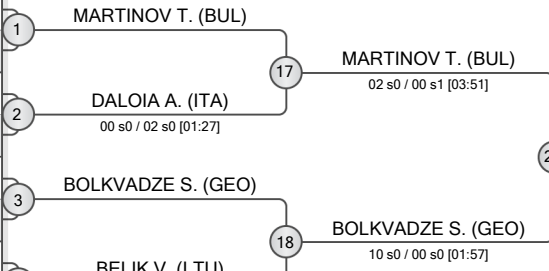

POOL B

	DOBROWOLSKI Bartlomiej	POL
	MAMMADLI Mehdi	AZE
	COLAK Ismail	AUT
	DAMM Oliver	HUN
	BILKA Oliver	SVK
	NEMSCHITZ Guy	ISR

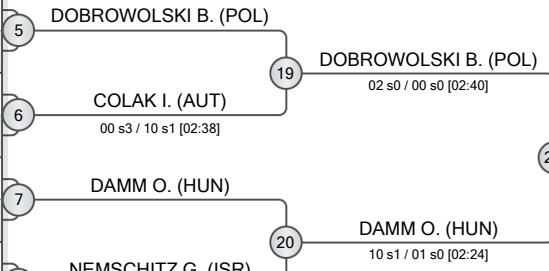

POOL C

	PENEZ Enzo	FRA
	LEITERT Csongor	HUN
	KOVAL Ivan	UKR
	ATANASOV Atanas	BUL
	GART Lidor	ISR
	ANASTASOPOULOS Dimitrios-Dionysios	GRE

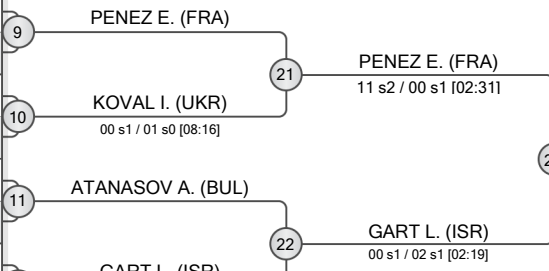

POOL D

	SZABO Milan	HUN
	ZUKAUSKAS Matas	LTU
	AKHUNDOV Ali	AZE
	DUFRAIGNE Mathis	FRA
	KHARIBEGASHVILI Daviti	GEO
	VLAD Sorin	ROU

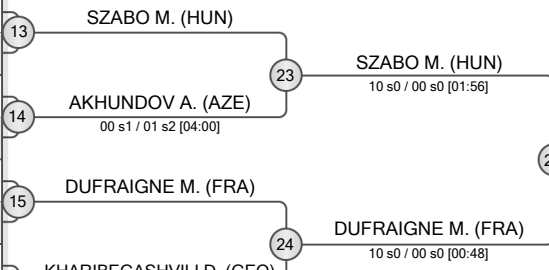

REPECHAGE

29 DALOIA A. (ITA)	30 NEMSCHITZ G. (ISR)	31 KOVAL I. (UKR)	32 AKHUNDOV A. (AZE)
33 BOLKVDZDE S. (GEO)	34 DOBROWOLSKI B. (POL)	35 GART L. (ISR)	36 DUFRAIGNE M. (FRA)

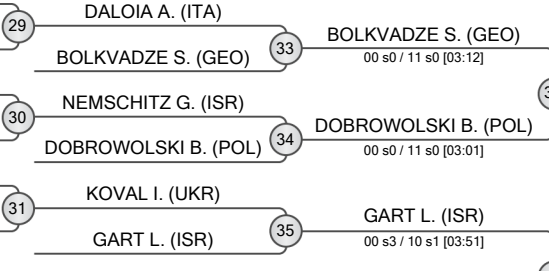

FINAL RESULTS	
1. SZABO Milan	HUN
2. MARTINOV Tsvetelin	BUL
3. BOLKVDZDE Saba	GEO
3. DUFRAIGNE Mathis	FRA
5. PENEZ Enzo	FRA
7. DOBROWOLSKI Bartlomiej	HUN
7. GART Lidor	ISR



Gyor Cadet European Cup 2024

Hungary, Gyor, 9-10 Nov 2024

-55 kg

Men (31)

POOL A

	BUTUCI Kristian	CRO
	LACIKA Silvio	SVK
	GOESCHKA Bernhard	AUT
	ZINCHUK Maksym	UKR
	PONEVACS Zoltan	HUN
	BUCUROIU Andrei	ROU
	GIVISHVILI Nikolozi	GEO

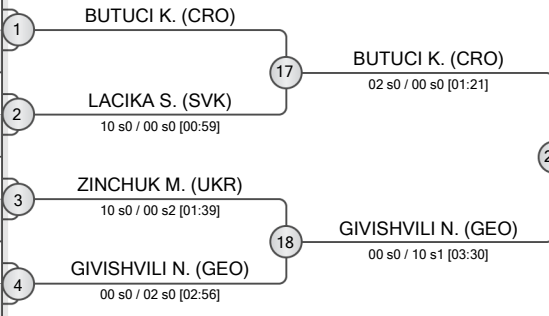

POOL B

	KELLY Kaian	AUS
	MAVRIDIS Leonidas	GRE
	TURCHYN Matviei	UKR
	CARNI Inbar	ISR
	MATVIICHUK Vladyslav	UKR
	STRASZAK Mateusz	POL
	ORNIK Yann	AUT
	MILOSEVIC Aleksa	SRB

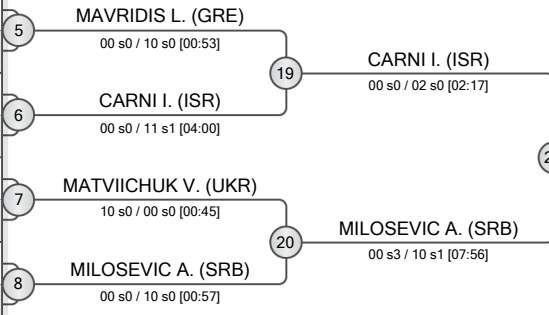

POOL C

	SORICI Alin Marian	ROU
	GALENKOV Ivo	BUL
	KOBRYN Oliwer	POL
	VAKIL Christoph	AUT
	ORUJOV Bayram	AZE
	RAJNIC Matej	SVK
	ROLNIK Gali	ISR
	TATARYN Nikita	UKR

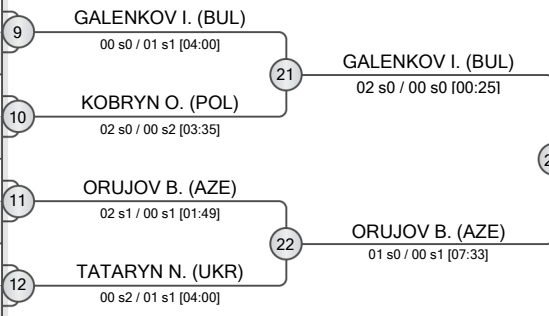

POOL D

	COOK Lochlan	AUS
	GOLDMAN Gilad	ISR
	KOSTOEV Adam	SWE
	KYREIEV Nikita	UKR
	WENCEL Jakub	POL
	MISKOVIC HASANBEGOVIC Noa	CRO
	FAQIR Sammy	HUN
	MARKOVICS Andrej	SVK

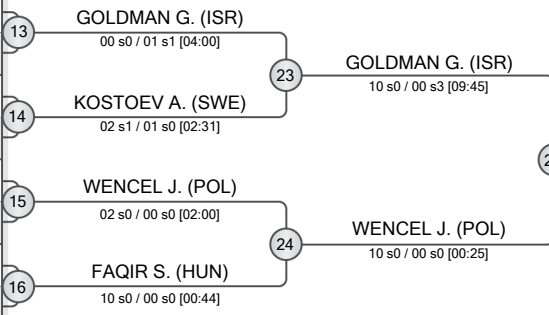

REPECHAGE

BUCUROIU A. (ROU)	29 ZINCHUK M. (UKR)
ZINCHUK M. (UKR)	30 MATVIICHUK V. (UKR)
ORNIK Y. (AUT)	31 TATARYN N. (UKR)
MATVIICHUK V. (UKR)	32 KOSTOEV A. (SWE)
RAJNIC M. (SVK)	33 BUTUCI K. (CRO)
TATARYN N. (UKR)	34 CARNI I. (ISR)
COOK L. (AUS)	35 GALENKOV I. (BUL)
KOSTOEV A. (SWE)	36 WENCEL J. (POL)

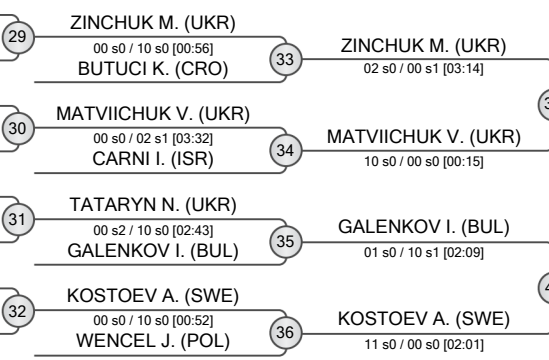

FINAL RESULTS

- ORUJOV Bayram (AZE)
- MILOSEVIC Aleksa (SRB)
- ZINCHUK Maksym (UKR)
- GIVISHVILI Nikolozi (GEO)
- GOLDMAN Gilad (ISR)
- GALENKOV Ivo (BUL)
- MATVIICHUK Vladyslav (UKR)
- KOSTOEV Adam (SWE)



Gyor Cadet European Cup 2024

Hungary, Gyor, 9-10 Nov 2024

-60 kg

Men (61)

POOL A

	GALO Bence	HUN
	PFANDL Jan	AUT
	BATALIN Nikita	UKR
	PIERROT Marius	FRA
	VAN TIJN Itay	ISR
	ISAKOV Nikola	SRB
	STEFANEK Hunor	HUN
	MICHALAK Wojciech	POL
	IONITA David	ROU
	KLIMENT Zalan	HUN
	LOBACHINSKY Lion	ISR
	LIAKHOVYI Mykhailo	UKR
	ATANASOV Yuliyian	BUL
	TOMASIC Mateo	CRO
	HASANOGLHU Omar	AZE

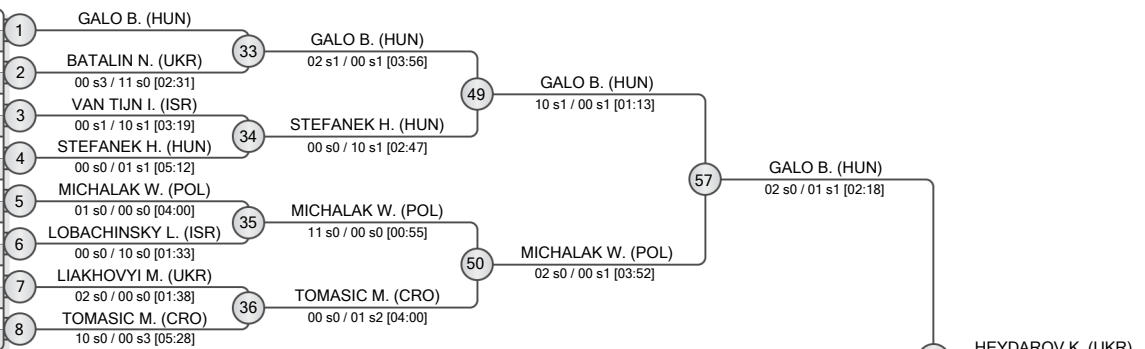

POOL B

	RADANOV Nikola	SRB
	SWOLKOWICZ Wojciech	POL
	TULINOV Tymur	UKR
	BRISUDA Filip	SVK
	PERGEL Tamas	HUN
	GEGIA Giorgi	GEO
	KHAMIYEV Sanan	AZE
	KAPLAN Yonatan	ISR
	FRIDMAN Maor	ISR
	VALJENT Matyas	CZE
	ASMAN Noah	AUS
	HEYDAROV Khazar	UKR
	CUCU Mihai	MDA
	SCHRODL Kornel	HUN
	OHRENSTEIN Yehonatan	ISR
	TODOROVIC Ivan	CRO

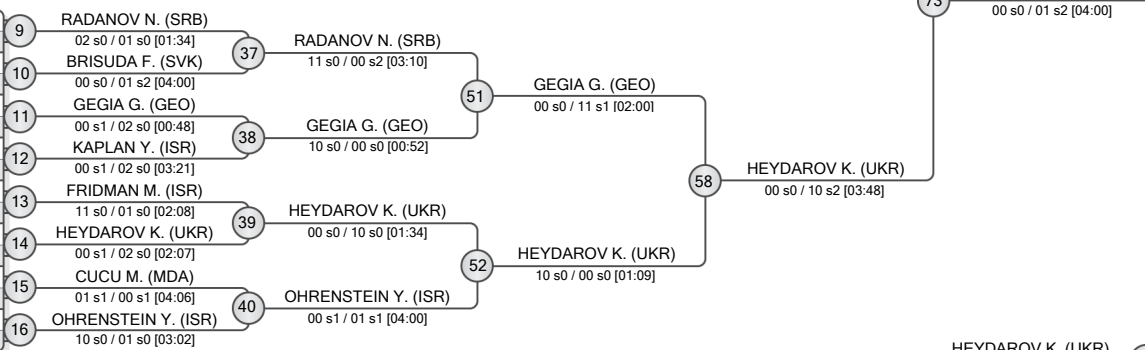

POOL C

	MUNIZ ACOSTA Jakub	POL
	SALVI Oskar	AUT
	POPIER Jan	SVK
	LANGE Marcus	DEN
	AMICHAI Yoav	ISR
	BASOV Renat	UKR
	SZEGNER Daniel	HUN
	JACKEVICIUS Rokas	LTU
	ALLAHVERDI Isa	AZE
	GARIC Maksim	SRB
	GREENBERG Omer	ISR
	PINKE Bence	HUN
	HONZAK Adam	CZE
	RIZEA Tudor	ROU
	MALIKOV Semen	UKR

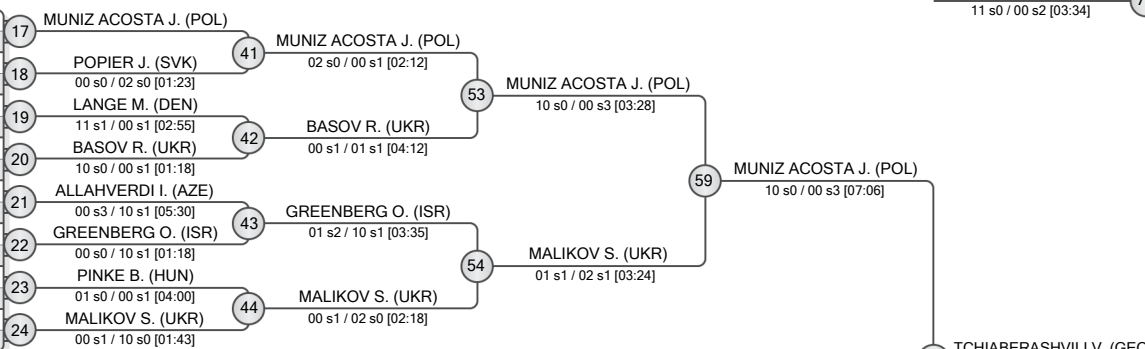

POOL D

	TCHIBERASHVILI Vakhtangi	GEO
	VASVARI Ianis Raul	ROU
	KISFOLDI Laszlo	HUN
	DURAK Dzan	BIH
	MAGURA Danilo	SRB
	ALIYEV Davud	AZE
	SNIR Yoav David	ISR
	WISNIEWSKI Dawid	POL
	SPICKA Matej	CZE
	BEZIC Ivan	CRO
	GILAD Itay	ISR
	ALYMBAEV Ayar	KGZ
	SHELEF Maayan	ISR
	NAGY Aron	HUN
	REMETSKI Mark	UKR

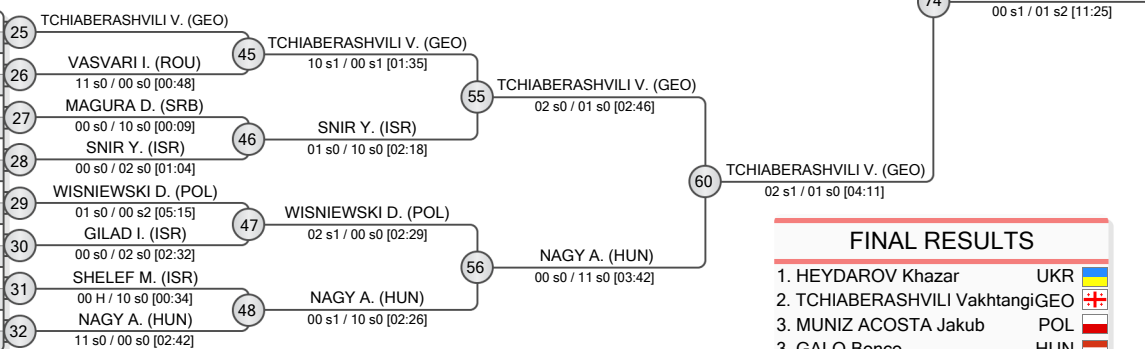

FINAL RESULTS		
1.	HEYDAROV Khazar	UKR
2.	TCHIBERASHVILI Vakhtangi	GEO
3.	MUNIZ ACOSTA Jakub	POL
3.	GALO Bence	HUN
5.	FRIDMAN Maor	ISR
5.	BASOV Renat	UKR
7.	MICHALAK Wojciech	POL
7.	NAGY Aron	HUN

REPECHAGE

	BATALIN N. (UKR)	61	BATALIN N. (UKR)
	ASMAN N. (AUS)	62	FRIDMAN M. (ISR)
	POPIER J. (SVK)	63	POPIER J. (SVK)
	VASVARI I. (ROU)	64	VASVARI I. (ROU)

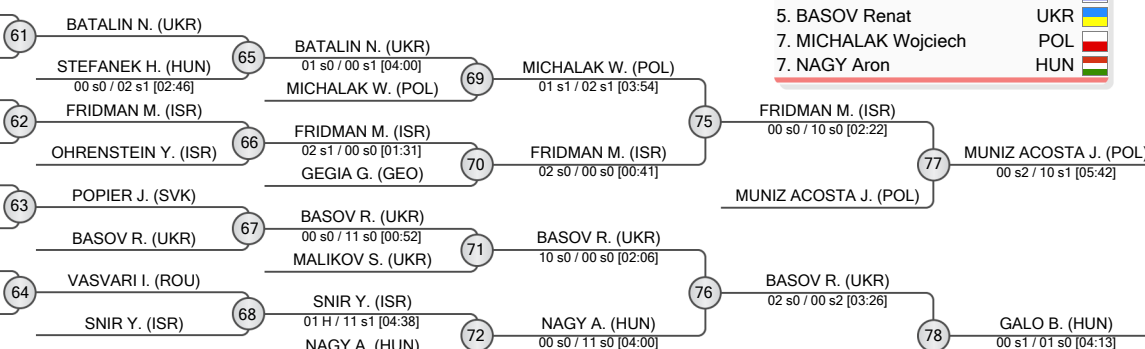



Gyor Cadet European Cup 2024

Hungary, Gyor, 9-10 Nov 2024

-66 kg

Men (65)

POOL A

UKR	1	NAZARENKO I. (UKR)
CZE	2	DVORAK P. (CZE)
LTU	3	BABRAVICIUS V. (LTU)
HUN	4	LENGYEL C. (HUN)
POL	5	ADAMOSZEK B. (POL)
MDA	6	SOLOTCHI V. (MDA)
ISR	7	HADAD L. (ISR)
HUN	8	GONDOR Kristof
SVK	8	TOMAS M. (SVK)
CRO	9	ROZGA R. (CRO)
HUN	10	FEKE A. (HUN)
ROU	11	MIRESCU C. (ROU)
BUL	12	GRIGOROV Y. (BUL)
AUT	13	KERN N. (AUT)
UKR	14	ZAPOROZHETS I. (UKR)
POL	15	GALINSKI M. (POL)
AZE	16	ABBASOV Y. (AZE)

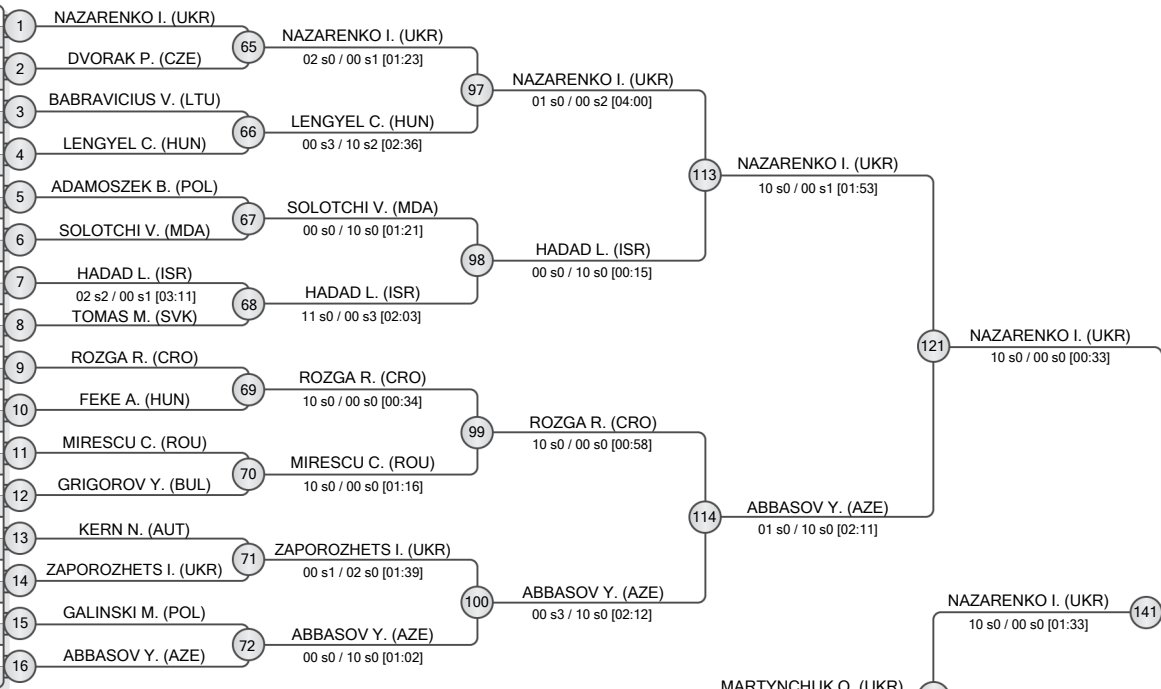

POOL B

CRO	17	HADZI-VELJKOVIC N. (CRO)
HUN	18	GAL K. (HUN)
UKR	19	HRYNKO B. (UKR)
ISR	20	PERTSEV E. (ISR)
AZE	21	SEYIDALIYEV S. (AZE)
LTU	22	KASPARAVICIUS N. (LTU)
SVK	23	SALAY R. (SVK)
BIH	24	SOMIC A. (BIH)
UKR	25	OSTAPENKO Bohdan
HUN	26	VARJU C. (HUN)
POL	27	SAPUNOV A. (POL)
AUT	28	ARSLAN H. (AUT)
ISR	29	MAOR R. (ISR)
GEO	30	SHERIPADZE D. (GEO)
DEN	31	NIELSEN E. (DEN)
BUL	32	PAVLOV P. (BUL)

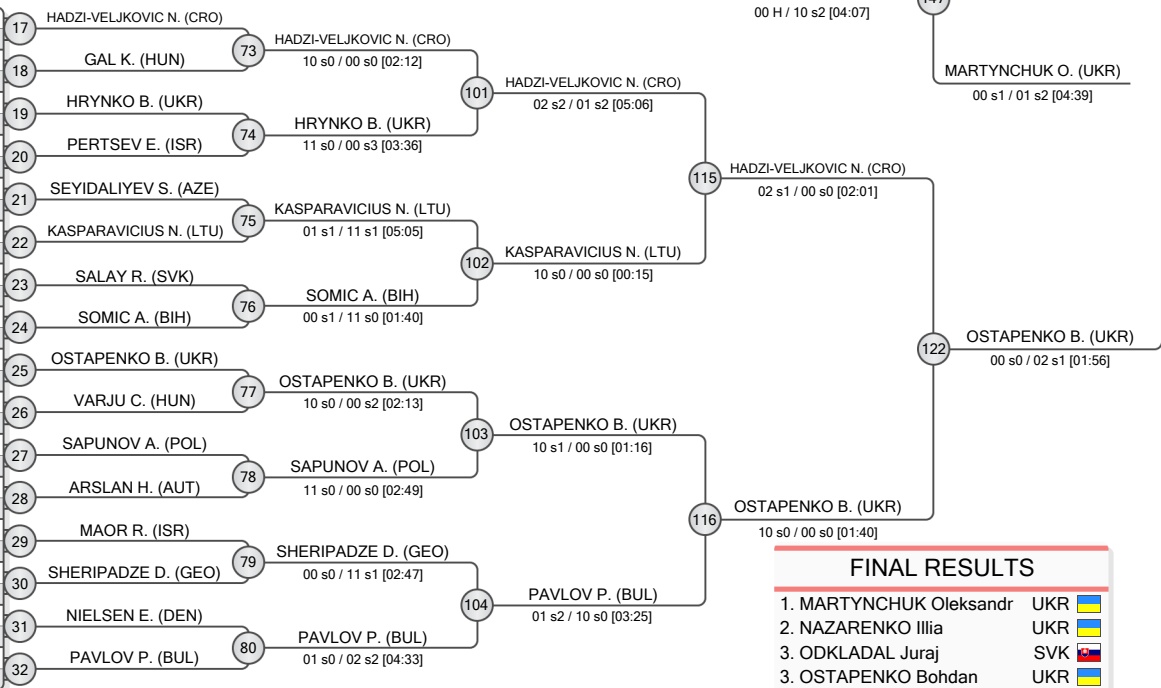

FINAL RESULTS		
1.	MARTYNCHUK Oleksandr	UKR
2.	NAZARENKO Illia	UKR
3.	ODKLADAL Juraj	SVK
4.	OSTAPENKO Bohdan	UKR
5.	ABBASOV Yusif	AZE
5.	STOEGMANN Stefan	AUT
7.	HADZI-VELJKOVIC Nikola	CRO
7.	NARKUS Girvydas	LTU

REPECHAGE

CZE	125	DVORAK P. (CZE)
HUN	126	VARJU C. (HUN)
LTU	127	SAVICKIS L. (LTU)
ISR	128	VIMER I. (ISR)

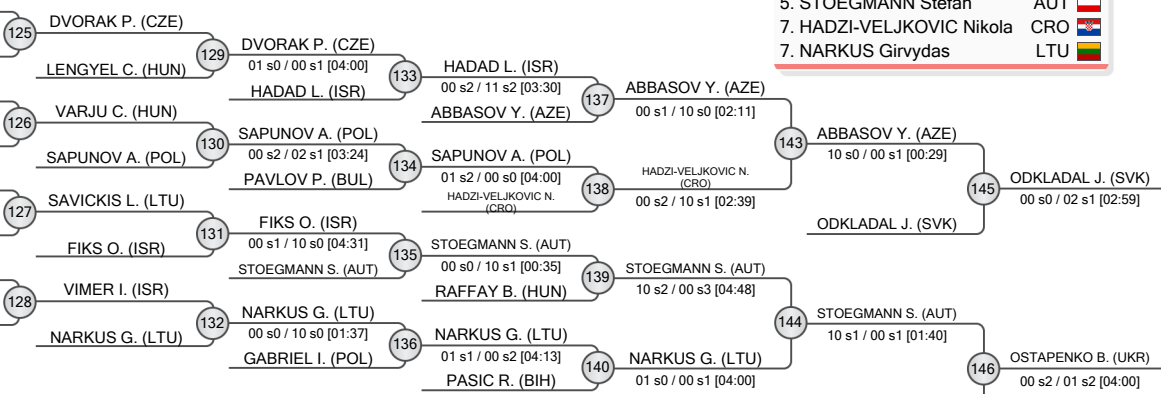



Gyor Cadet European Cup 2024

Hungary, Gyor, 9-10 Nov 2024

-66 kg

Men (65)

POOL C

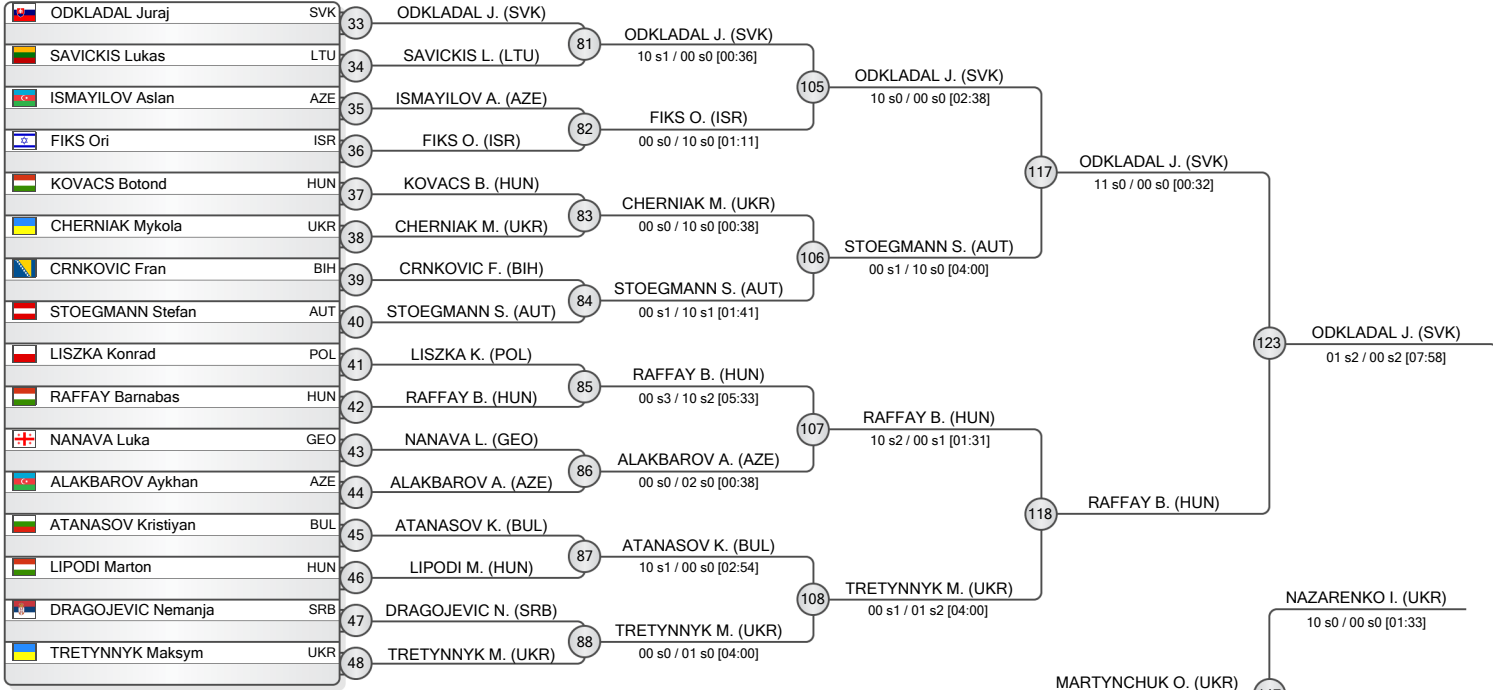

POOL D

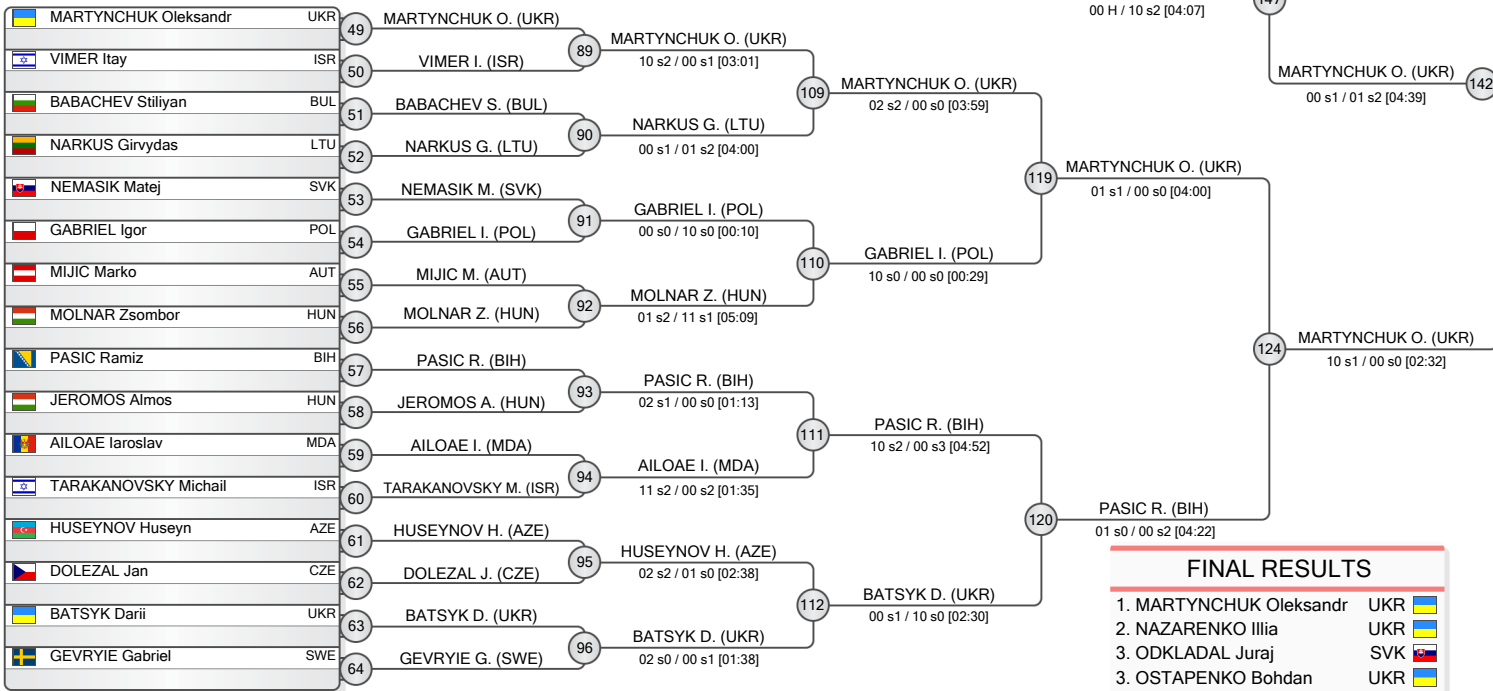

FINAL RESULTS		
1.	MARTYNCHUK Oleksandr	UKR
2.	NAZARENKO Illia	UKR
3.	ODKLADAL Juraj	SVK
3.	OSTAPENKO Bohdan	UKR
5.	ABBASOV Yusif	AZE
7.	STOEGMANN Stefan	AUT
7.	HADZI-VELJKOVIC Nikola	CRO
7.	NARKUS Girvydas	LTU

REPECHAGE

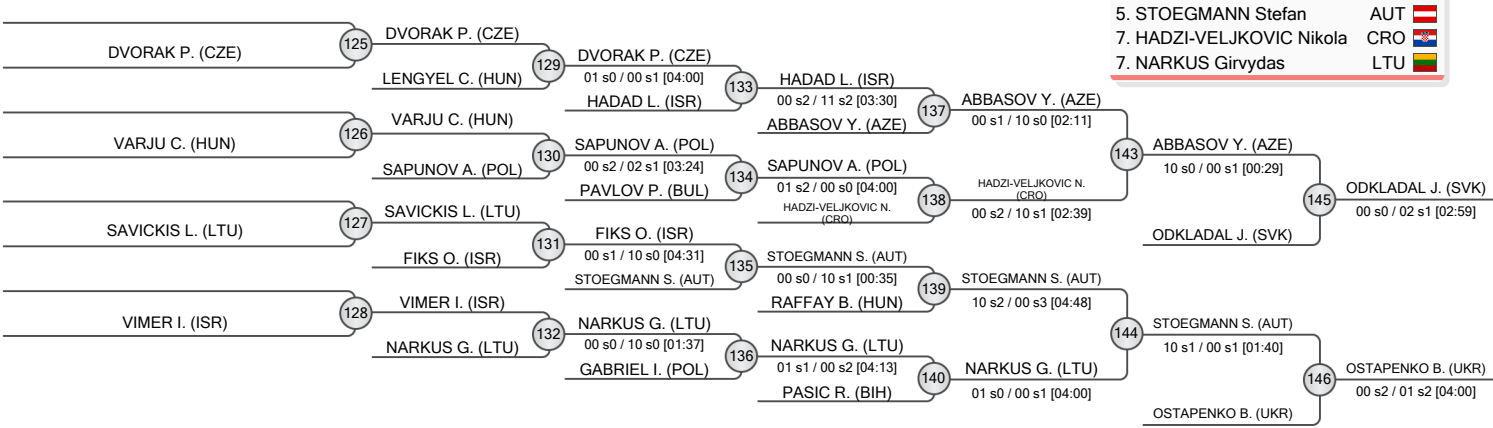



Gyor Cadet European Cup 2024

Hungary, Gyor, 9-10 Nov 2024

-73 kg

Men (68)

POOL C

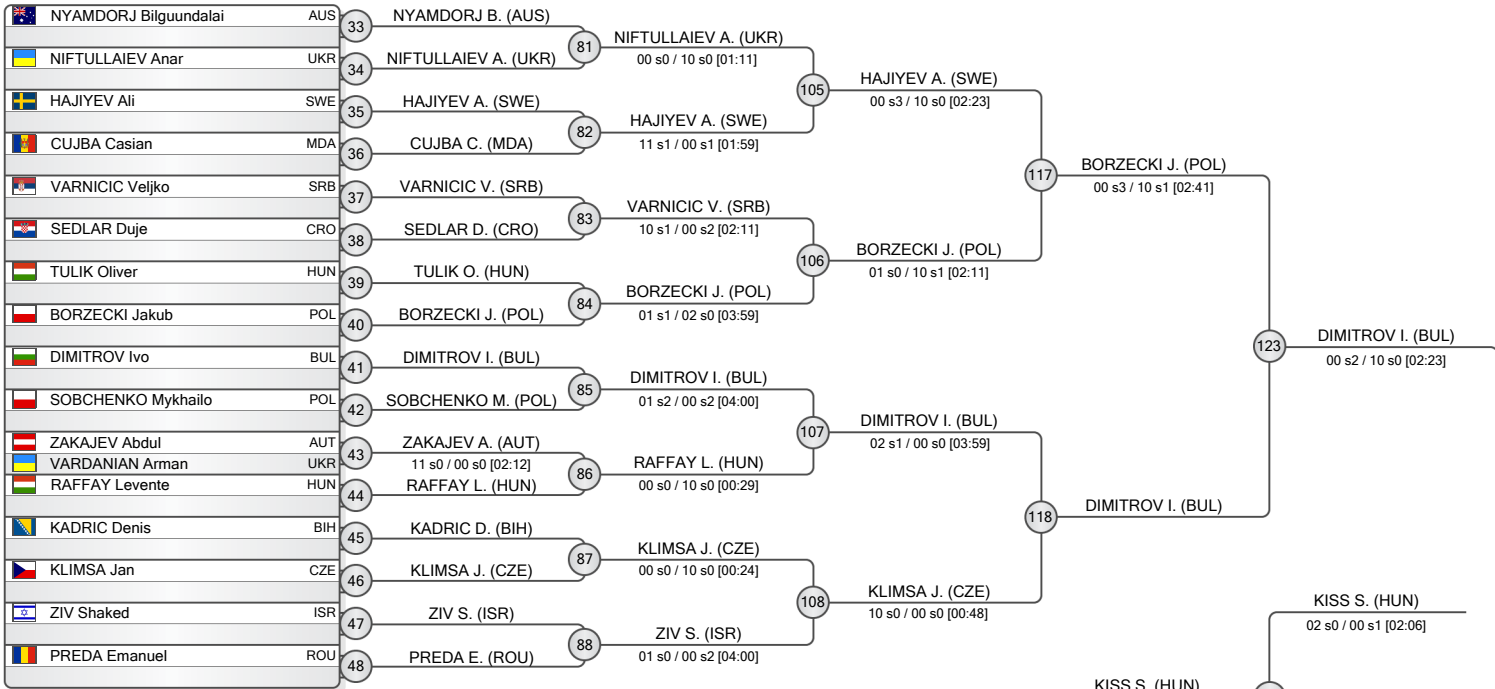

POOL D

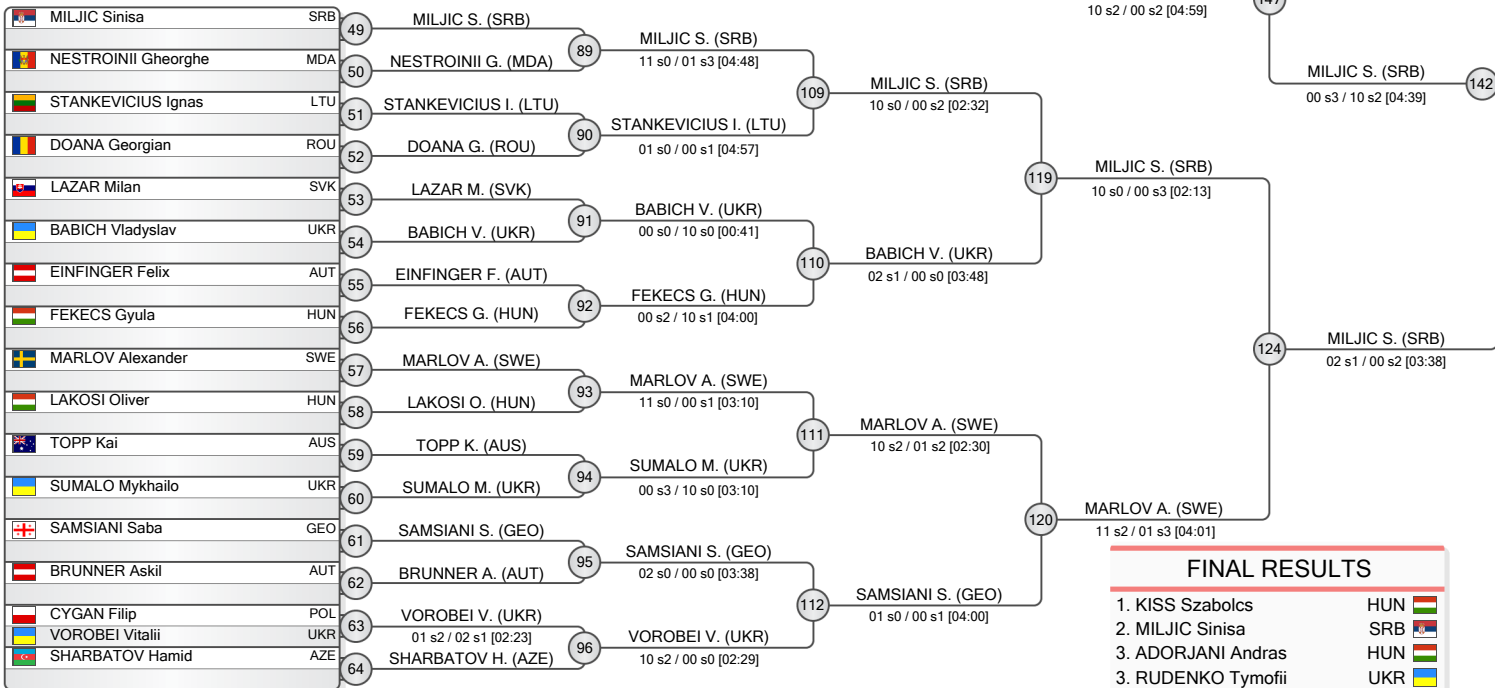

FINAL RESULTS		
1.	KISS Szabolcs	HUN
2.	MILJIC Sinisa	SRB
3.	ADORJANI Andras	HUN
3.	RUDENKO Tymofii	UKR
5.	DIMITROV Ivo	BUL
5.	MARLOV Alexander	SWE
7.	MAKHASHEV Elbert	AUT
7.	BORZECKI Jakub	POL

REPECHAGE

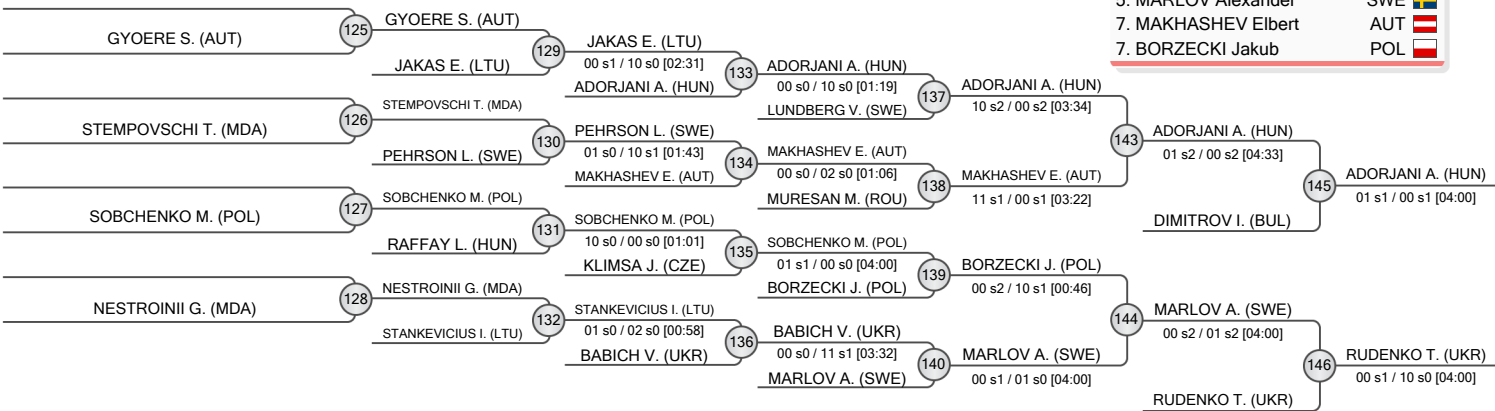



Gyor Cadet European Cup 2024

Hungary, Gyor, 9-10 Nov 2024

-81 kg

Men (65)

POOL A

	KELLY Akos	AUS	1	KELLY A. (AUS)
	SHNIDERMAN Liroy	ISR	2	SHNIDERMAN L. (ISR)
	TOLGYESI Bende	HUN	3	TOLGYESI B. (HUN)
	IGNAT Darius Stefan	ROU	4	IGNAT D. (ROU)
	HAISHUK Mykyta	UKR	5	HAISHUK M. (UKR)
	KLIMES Vojtech	CZE	6	KLIMES V. (CZE)
	ZEIDGULIYEV Akif	AZE	7	ZEIDGULIYEV A. (AZE)
	HAJNECKY Marco	SVK	8	HAJNECKY M. (SVK)
	CAPEZZUTO Antonio	ITA	9	CAPEZZUTO A. (ITA)
	KARAKIN Serhii	UKR	10	KARAKIN S. (UKR)
	HERNADI Csongor	HUN	11	HERNADI C. (HUN)
	RACKA Norbertas	LTU	12	RACKA N. (LTU)
	GRABNER Erik	AUT	13	GRABNER E. (AUT)
	LAZAROV Ventsislav	BUL	14	LAZAROV V. (BUL)
	SLOVIC Milos	SRB	15	SLOVIC M. (SRB)
	ROTAR Maksym	UKR	16	ROTAR M. (UKR)

POOL B

	GUSIC Imran	BIH	17	GUSIC I. (BIH)
	MARTIS Jakub	SVK	18	MARTIS J. (SVK)
	BOUNTANIOTIS Georgios	GRE	19	MARGREITER S. (AUT)
	MARGREITER Simon	AUT	19	MARGREITER S. (AUT)
	VLAHOV Andrija	CRO	20	VLAHOV A. (CRO)
	STANIEK Szymon	POL	21	STANIEK S. (POL)
	BACIU Dumitru	MDA	22	BACIU D. (MDA)
	MIKLOSVOLGYI Mate	HUN	23	MIKLOSVOLGYI M. (HUN)
	SUTU Vasyi	UKR	24	SUTU V. (UKR)
	ZURABASHVILI Giorgi	GEO	25	ZURABASHVILI G. (GEO)
	VANIARKHA Vladyslav	UKR	26	VANIARKHA V. (UKR)
	JOVANOVIC Todor	SRB	27	JOVANOVIC T. (SRB)
	PRIKKEL Zsombor	HUN	28	PRIKKEL Z. (HUN)
	MEHDIYEV Ahmad	AZE	29	MEHDIYEV A. (AZE)
	HALASZ Aron	HUN	30	HALASZ A. (HUN)
	GARAGAU Razvan	ROU	31	GARAGAU R. (ROU)
	GORUN Volodymyr	UKR	32	GORUN V. (UKR)

REPECHAGE

125	CAPEZZUTO A. (ITA)
126	MARTIS J. (SVK)
127	WOERMANSEDER K. (AUT)
128	BASAN U. (UKR)
129	RACKA N. (LTU)
130	VLAHOV A. (CRO)
131	HORVATH N. (HUN)
132	SVALINA N. (CRO)
133	GRABNER E. (AUT)
134	SUTU V. (UKR)
135	HORVATH N. (HUN)
136	BETKOWSKI J. (POL)
137	TOLGYESI B. (HUN)
138	GORUN V. (UKR)
139	BABAICENKO T. (LTU)
140	HARMASH I. (UKR)
141	KARAKIN S. (UKR)
142	GUSIC I. (BIH)
143	GORUN V. (UKR)
144	HARMASH I. (UKR)
145	GORUN V. (UKR)
146	HARMASH I. (UKR)

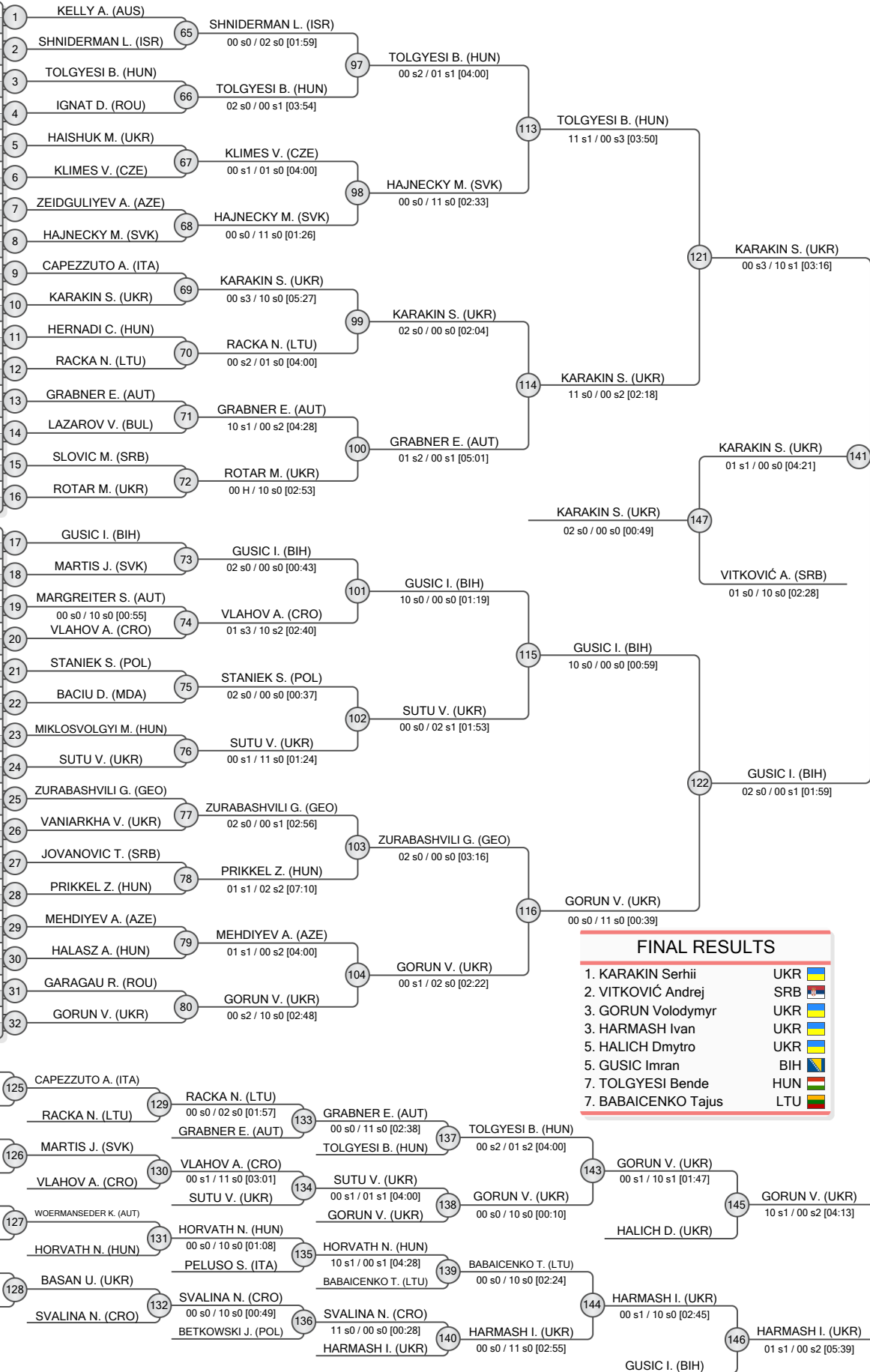



Gyor Cadet European Cup 2024

Hungary, Gyor, 9-10 Nov 2024

-81 kg

Men (65)

POOL C

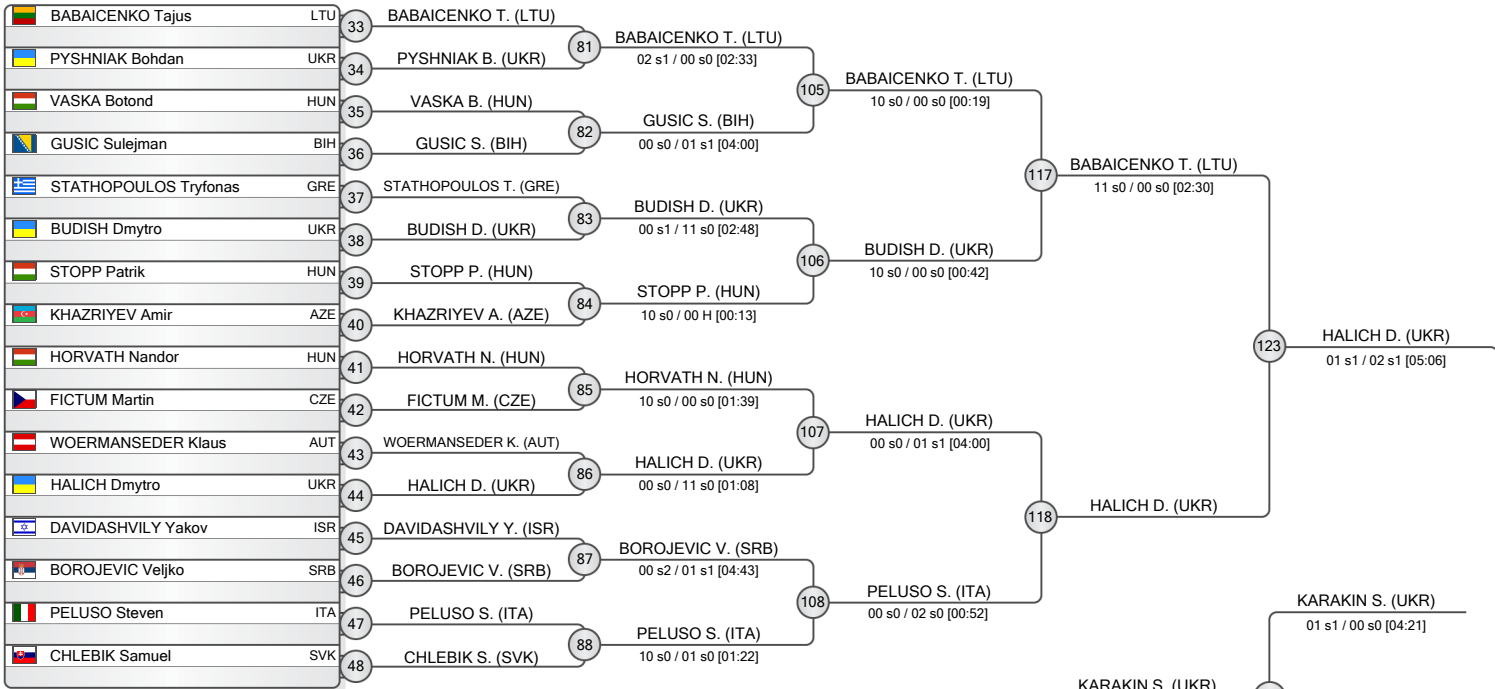

POOL D

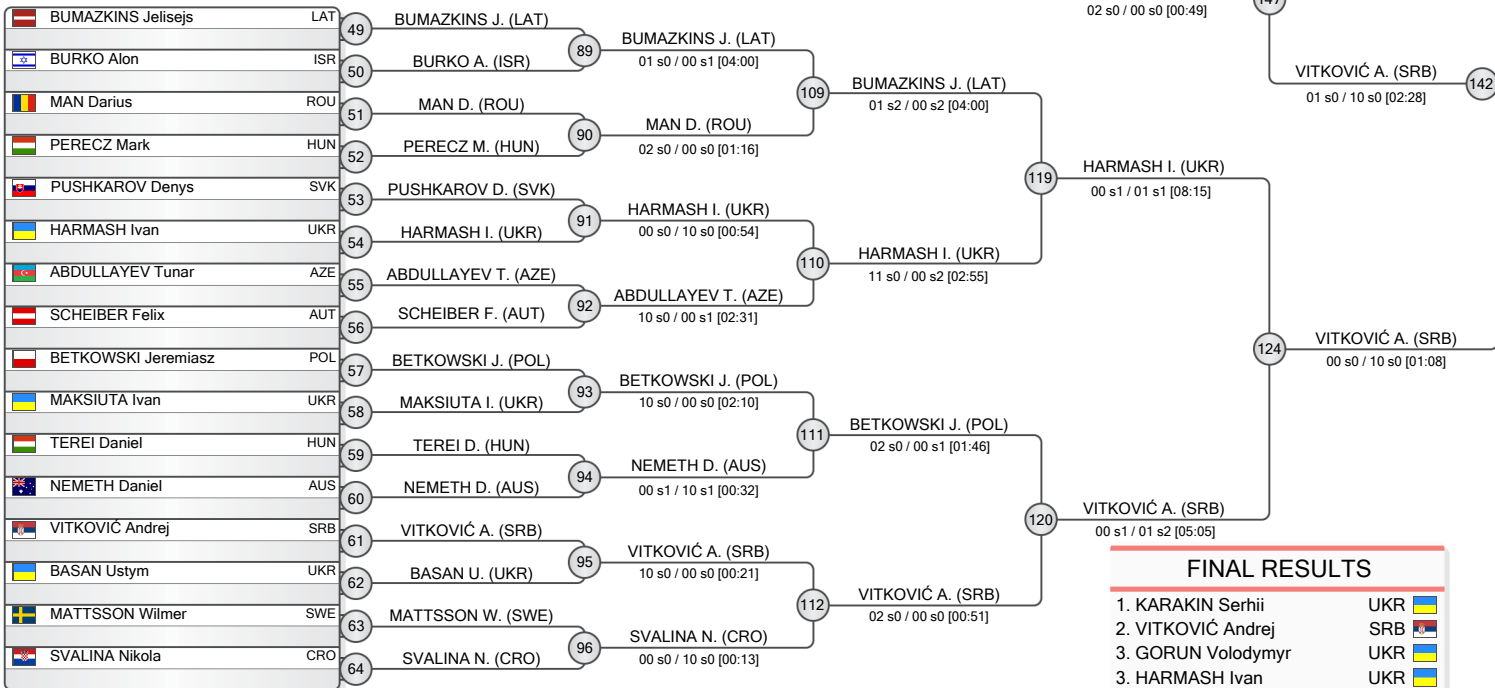

REPECHAGE

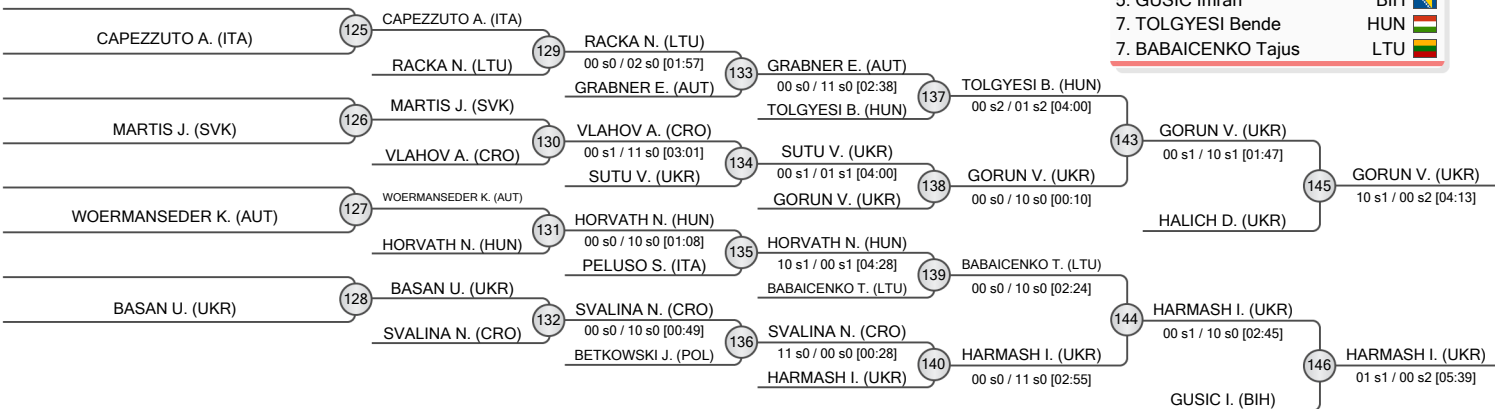

FINAL RESULTS		
1.	KARAKIN Serhii	UKR
2.	VITKOVIĆ Andrej	SRB
3.	GORUN Volodymyr	UKR
3.	HARMASH Ivan	UKR
5.	HALICH Dmytro	UKR
7.	TOLGYESI Bende	HUN
7.	BABAICENKO Tajus	LTU



Gyor Cadet European Cup 2024

Hungary, Gyor, 9-10 Nov 2024

-90 kg

Men (29)

POOL A

	SAMOILOV Arkadii	UKR
	TAKACS Abel	HUN
	ALIYEV Janpolad	AZE
	LASZCZOK Nikodem	POL
	TOTH Zsombor	HUN
	OHAYON Noam	ISR
	HECKO Daniel	SVK

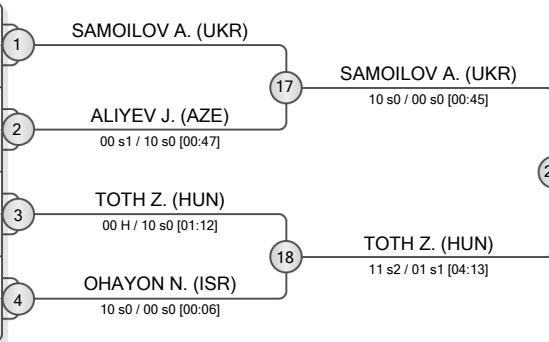

POOL B

	SIMIC Nemanja	SRB
	NONCHEV Dimitar	BUL
	BILOUS Illia	UKR
	SALAMON Barnabas	HUN
	HORNGACHER Lorenz	AUT
	KOVACS Mark	HUN
	CZIBULA Bernat	HUN
	RICHTER Mikulas	CZE

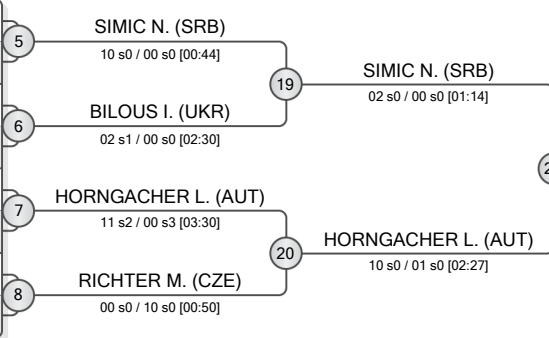

POOL C

	GENYS Majus	LTU
	PASZEK Damian	POL
	KORODI Zsombor	HUN
	SVATEK Jozef	SVK
	GREINER Christian	AUT
	GAL Ofri	ISR
	TORMA Zalan	HUN

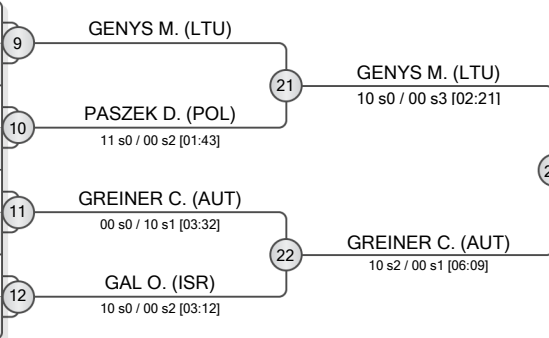

POOL D

	PETRAUSKAS Majus	LTU
	OBRADOVIC Nikola	SRB
	KERTAI Oliver	HUN
	KOGUASHVILI Giorgi	GEO
	MAKARENKO Artur	UKR
	LOVASZI Bendeguz	HUN
	NEACSU Rares	ROU

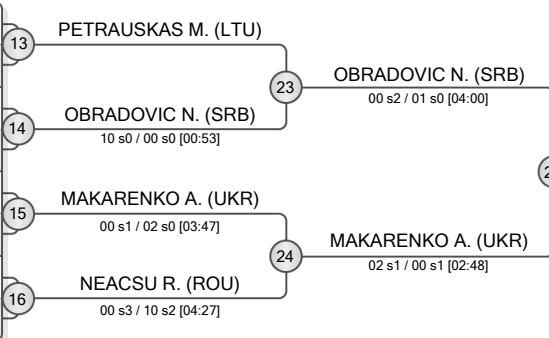

REPECHAGE

29	ALIYEV J. (AZE)	33	ALIYEV J. (AZE)
30	NONCHEV D. (BUL)	34	BILOUS I. (UKR)
31	PASZEK D. (POL)	35	PASZEK D. (POL)
32	PETRAUSKAS M. (LTU)	36	MAKARENKO A. (UKR)

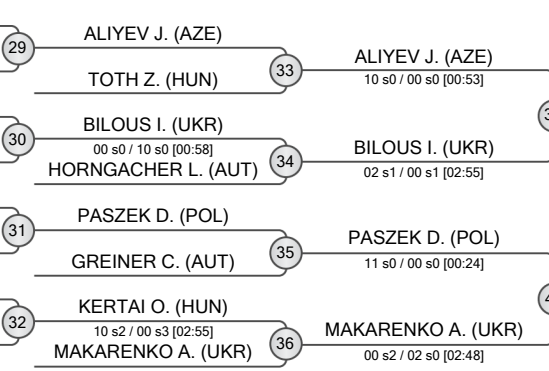

FINAL RESULTS	
1.	GENYS Majus (LTU)
2.	SIMIC Nemanja (SRB)
3.	ALIYEV Janpolad (AZE)
3.	SAMOILOV Arkadii (UKR)
5.	OBRADOVIC Nikola (SRB)
7.	BILOUS Illia (UKR)
7.	PASZEK Damian (POL)



Gyor Cadet European Cup 2024

Hungary, Gyor, 9-10 Nov 2024

+ 90 kg

Men (20)

POOL A

	NOVAKOVIC Petar	SRB
	TIUKH Yurii	UKR
	MASIMOV Javidan	AZE
	STIVENSON Arthur	CAN
	FALUSI Zsolt	HUN

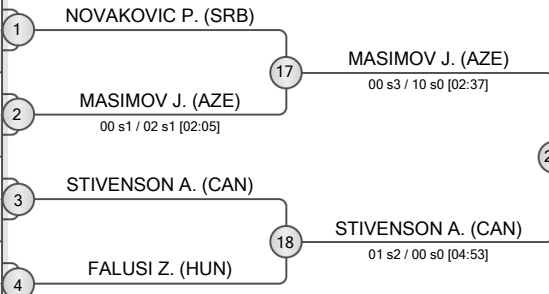

POOL B

	LUBURA Nikola	BIH
	PETROVSZKI Mark	HUN
	ZHADAN Serhii	UKR
	CORKOVIC Filip	SRB
	TRUHLAR Martin	CZE

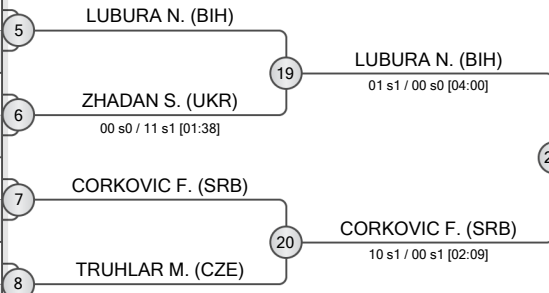

POOL C

	ABALAKI Ioane	GEO
	CSERMAK Daniel	HUN
	BERECKA Pjer	CRO
	PALEICIKAS Nikolas	LTU
	MUHTARI Imran	BIH

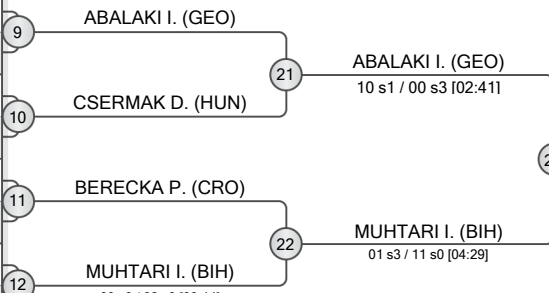

POOL D

	SZEKERES Abel	HUN
	SHYSHOV Mykhailo	UKR
	CUIBUS Raul	ROU
	ANGERER Lukas	AUT
	DZAPKU Armin	HUN

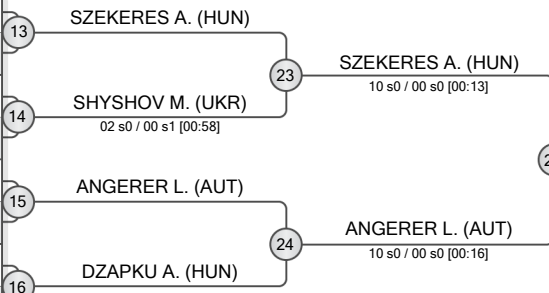

REPECHAGE

29	TIUKH Y. (UKR)	TIUKH Y. (UKR)
30	NOVAKOVIC P. (SRB)	ZHADAN S. (UKR)
31	ZHADAN S. (UKR)	CSERMAK D. (HUN)
32	CSERMAK D. (HUN)	SHYSHOV M. (UKR)

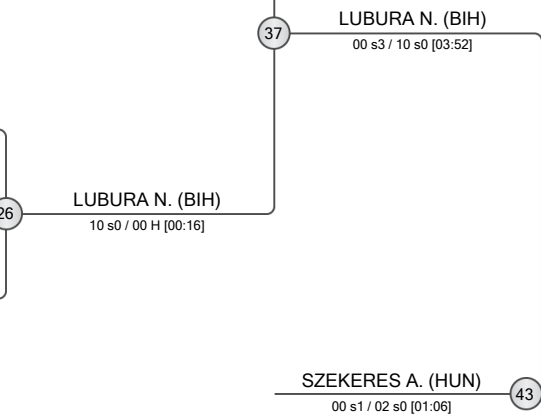
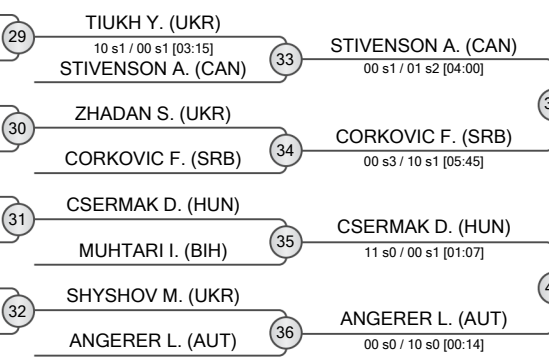

FINAL RESULTS		
1.	SZEKERES Abel	HUN
2.	LUBURA Nikola	BIH
3.	ABALAKI Ioane	GEO
3.	CSERMAK Daniel	HUN
5.	CORKOVIC Filip	SRB
7.	MASIMOV Javidan	AZE
7.	STIVENSON Arthur	CAN
7.	ANGERER Lukas	AUT



Gyor Cadet European Cup 2024

Hungary, Gyor, 9-10 Nov 2024

-40 kg

Women (2)

Num.	Competitor	State	1	2	Wins	Points
1.	PIRBUS-GROF Nora	Hungary		1	1	1
2.	SIRKO Dalma	Hungary	0		0	0

PIRBUS-GROF Nora	HUN
SIRKO Dalma	HUN

1

PIRBUS-GROF N. (HUN)

01 s1 / 00 s0 [04:00]

FINAL RESULTS	
1. PIRBUS-GROF Nora	HUN

POOL A

	TANACKOV Marija	SRB
	NOSENKO Yelyzaveta	UKR
	LIBERMAN Shir	ISR

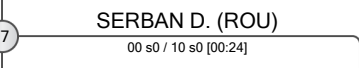
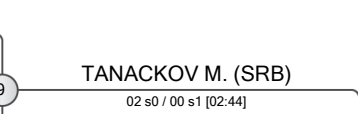
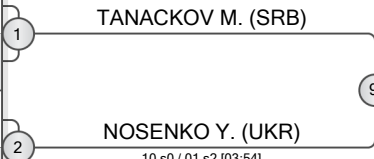

POOL B

	SERBAN Denisa	ROU
	PAPAI Stella	HUN

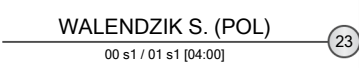
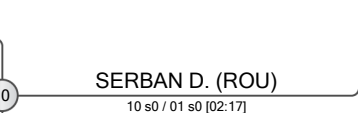
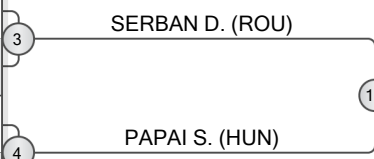

POOL C

	WALENDZIK Sandra	POL
	DUBLJEVIC Ivana	SRB
	VASILEVA Raya	BUL

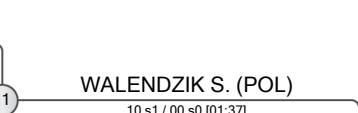
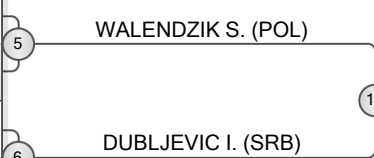

POOL D

	GORANOVIC Katarina	SRB
	BLASZCZYK Julia	POL
	KUNYIK Laura-Sophie	AUT

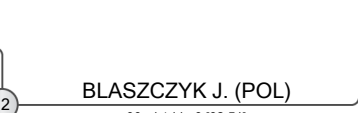
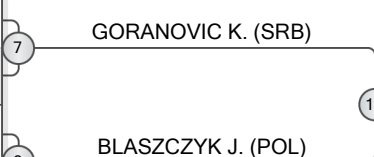

FINAL RESULTS		
1.	WALENDZIK Sandra	POL
2.	SERBAN Denisa	ROU
3.	PAPAI Stella	HUN
3.	TANACKOV Marija	SRB
5.	BLASZCZYK Julia	POL
5.	KUNYIK Laura-Sophie	AUT
7.	NOSENKO Yelyzaveta	UKR
7.	DUBLJEVIC Ivana	SRB

REPECHAGE

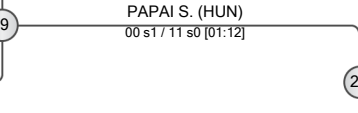
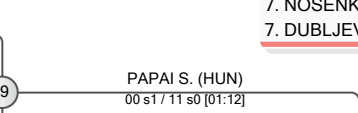
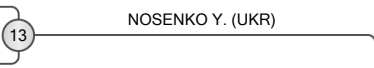



Gyor Cadet European Cup 2024

Hungary, Gyor, 9-10 Nov 2024

-48 kg

Women (24)

POOL A

	HIROSE Rika	AUS
	PETERSON Elsa	SWE
	STOLLAROVA Sofia	SVK
	MAYRHOFER Lena	AUT
	PRATH Irisz	HUN
	KOVACHEVA Preslava	BUL

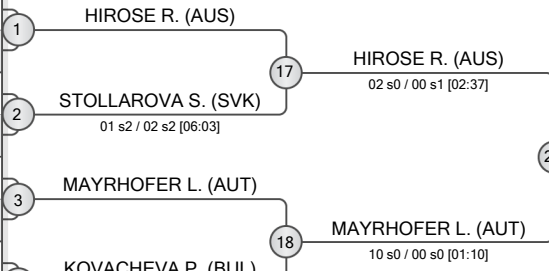

POOL B

	TUCAJ Martina	CRO
	TUERK Helin	AUT
	ZITOUNI Shelssy	FRA
	PEREIRA Mariana	POR
	ILIEVA Andrea	BUL
	LUPTAKOVA Paulina	SVK

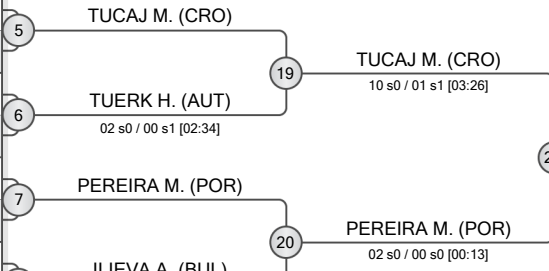

POOL C

	KISS Viktoria	HUN
	NEDVYHA Yaroslava	UKR
	ANTOVA Zoya	BUL
	PODYMSKA Nina	POL
	MATEJKOVA Teresa	SVK
	PULJIC Lucija	CRO

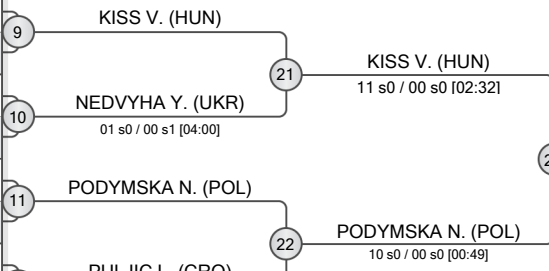

POOL D

	KRIZOVA Kristina Lili	SVK
	GANGL Anna	AUT
	GRIGOROVA Kalina	BUL
	CULJAK Petra	BIH
	MAKKAI Szonja	HUN
	MUNTEANU Ana Maria	ROU

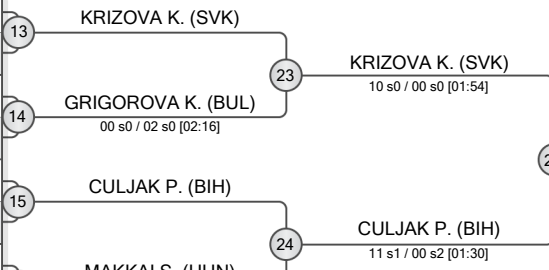

REPECHAGE

STOLLAROVA S. (SVK)	29	STOLLAROVA S. (SVK)	33	MAYRHOFER L. (AUT)
TUERK H. (AUT)	30	TUERK H. (AUT)	34	PEREIRA M. (POR)
NEDVYHA Y. (UKR)	31	NEDVYHA Y. (UKR)	35	PODYMSKA N. (POL)
GRIGOROVA K. (BUL)	32	GRIGOROVA K. (BUL)	36	CULJAK P. (BIH)

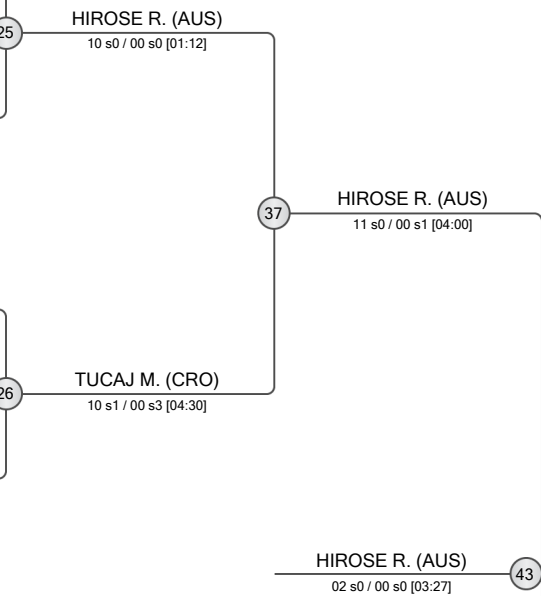
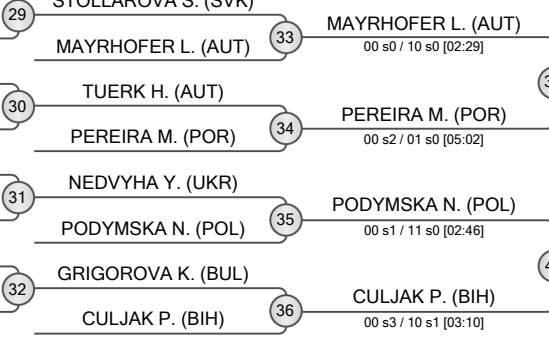

FINAL RESULTS		
1.	HIROSE Rika	AUS
2.	KRIZOVA Kristina Lili	SVK
3.	KISS Viktoria	HUN
3.	TUCAJ Martina	CRO
5.	PEREIRA Mariana	POR
5.	PODYMSKA Nina	POL
7.	MAYRHOFER Lena	AUT
7.	CULJAK Petra	BIH



Gyor Cadet European Cup 2024

Hungary, Gyor, 9-10 Nov 2024

-52 kg

Women (31)

POOL A

	VAS Mira	HUN
	MIKOTA Katharina	AUT
	IERMOLENKO Ielyzaveta	UKR
	ZARUBA Viktorija	LTU
	KEJDOVA Emma	CZE
	ZIVKOVIC Valentina	CRO
	TEISANU Teodora	ROU

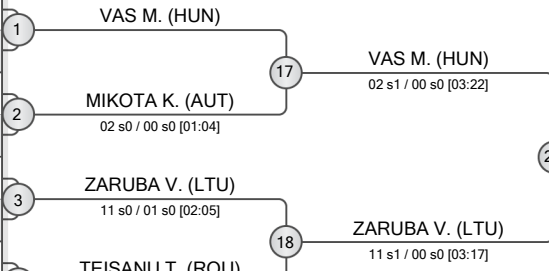

POOL B

	CORDOVA Sofia	SWE
	IATAGAN Maria	ROU
	SUVEGES Fanni	HUN
	FROSZTEGA Iga	POL
	YEMELIANOVA Yelyzaveta	UKR
	HARANI Talya	ISR
	VADOVICOVA Vivien	SVK
	SLOTH HANSEN Alice	DEN

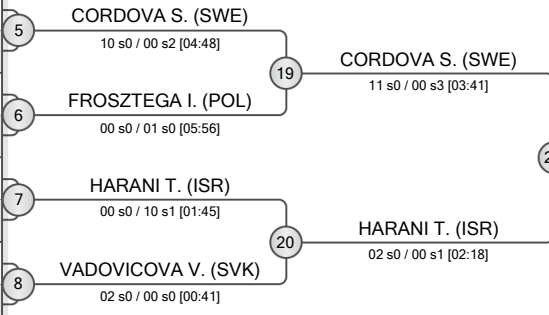

POOL C

	BARISIC Laura	CRO
	RAUS Kira	HUN
	LAVRENOVA Kamila	UKR
	TOMESCU Yasmine	ROU
	SZABO Reka	HUN
	STOEVA Andrea	BUL
	BUSAUSKAITE Migne	LTU
	VRBOVSKA Laura	SVK

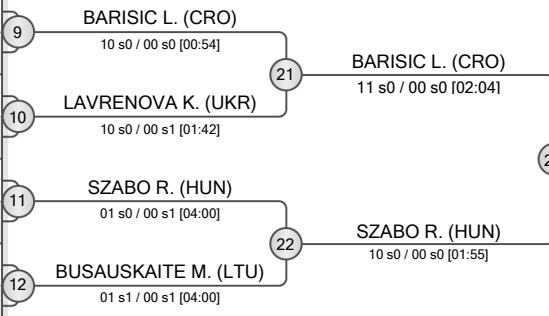

POOL D

	MOS Marika	POL
	POSPISILOVA Adela	CZE
	MANDA Lorena	ROU
	PALLAI Dora	HUN
	GRZESZCZYK Otylia	POL
	NEVO Liri	ISR
	STOJANOV Lenka	SRB
	MOMOT Neonila	UKR

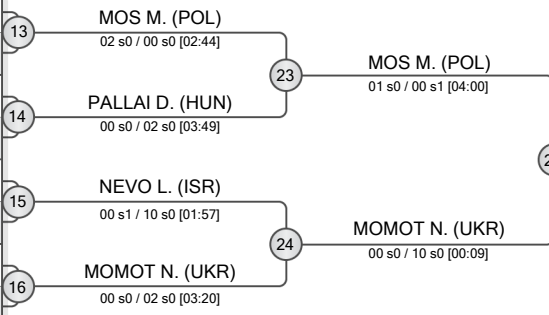

REPECHAGE

MIKOTA K. (AUT)	29	MIKOTA K. (AUT)	33
YEMELIANOVA Y. (UKR)		ZARUBA V. (LTU)	
VADOVICOVA V. (SVK)	30	VADOVICOVA V. (SVK)	34
STOEVA A. (BUL)		CORDOVA S. (SWE)	
BUSAUSKAITE M. (LTU)	31	BUSAUSKAITE M. (LTU)	35
POSPISILOVA A. (CZE)		BARISIC L. (CRO)	
PALLAI D. (HUN)	32	PALLAI D. (HUN)	36
		MOMOT N. (UKR)	

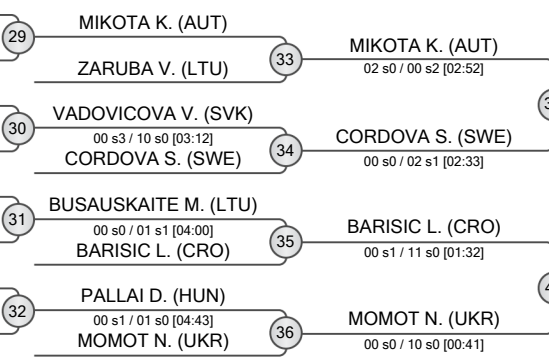

FINAL RESULTS	
1. VAS Mira	HUN
2. SZABO Reka	HUN
3. MOS Marika	POL
3. HARANI Talya	ISR
5. CORDOVA Sofia	SWE
7. MIKOTA Katharina	AUT
7. BARISIC Laura	CRO



Gyor Cadet European Cup 2024

Hungary, Gyor, 9-10 Nov 2024

-57 kg

Women (46)

POOL A

1	VEINHANDL OBAID Haya SLO
2	HULOVA Karolina CZE
3	TAMTAM Greta HUN
4	LOURENCO Rita POR
5	BOLTVANNOVA Lea SVK
6	ZEDDA Lucrezia ITA
7	MAJ Veronika HUN
8	JANUSZ Urszula POL
9	MEKAITON Shira ISR
10	SEYR Julia AUT
11	STAIKU Patricia ROU

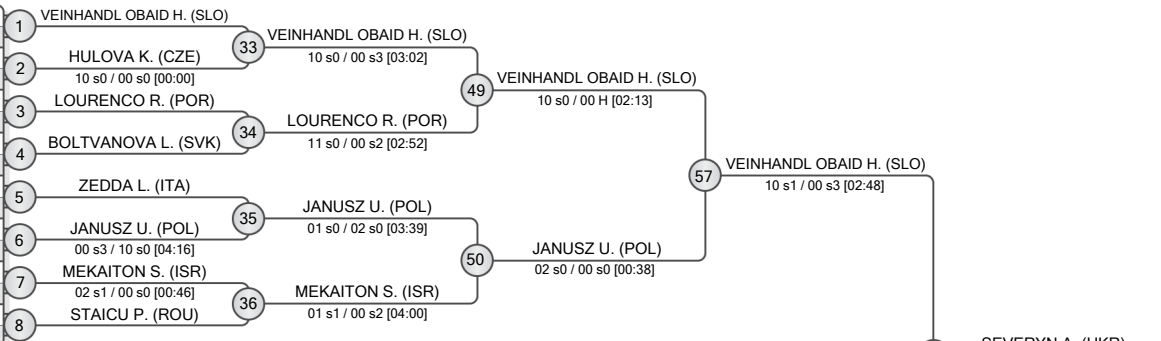

POOL B

9	GLIGA Ana ROU
10	KISSOVA Natalia SVK
11	BARTYIK Iza HUN
12	VONDRAKOVA Lada CZE
13	KOSHNITZKY Maya ISR
14	ANETSHOFER Helena AUT
15	BORCZ Blanka POL
16	VOJDOVA Zoe SVK
17	JUTTNER Janka HUN
18	MARKOVIC Nikolina Karla CRO
19	BAUER Susanne AUT
20	SEVERYN Anastasiia UKR

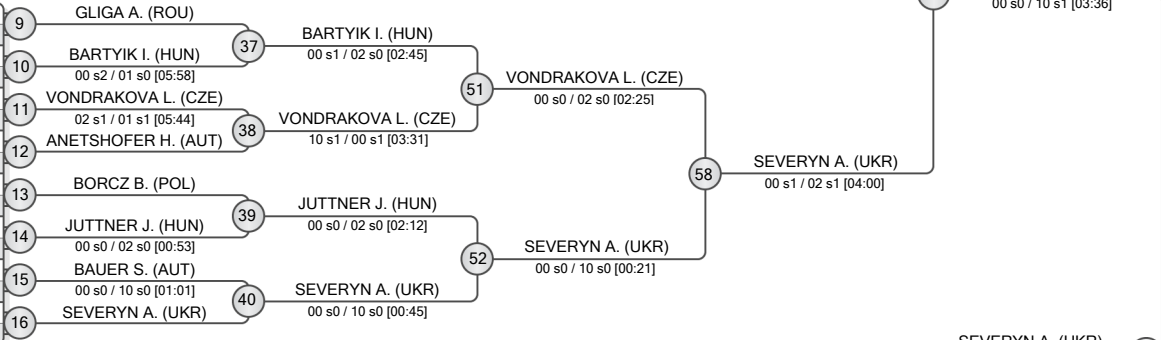

POOL C

17	WALEGA Magdalena POL
18	BOZSO Zita HUN
19	HALLER Eva AUT
20	KADIC Ira CRO
21	SHTEPU Yelyzaveta UKR
22	DANISOVA Ema SVK
23	DYE Isciane FRA
24	MRAZ Dora HUN
25	PERRY Gil ISR
26	SCHINWALD Marlene AUT
27	KRAUS Daria ROU

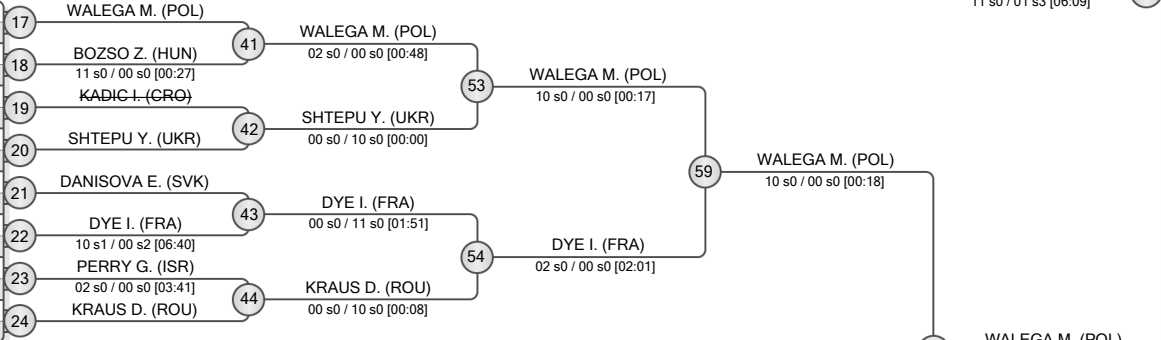

POOL D

25	BABULFATH Hanna SWE
26	MOKRY Sandra POL
27	NEAGU Isabela Ioana ROU
28	JONAS Maayan ISR
29	MOHAROS Zsofia HUN
30	GANOVSKA Sofia SVK
31	MARKOVICSOVA Emma SVK
32	BOIKO Lucija CRO
33	BOIKO Veronika UKR
34	HERMANOVA Karolina CZE
35	SCHWARZBAUER Carina AUT
36	VARADI Noemi HUN

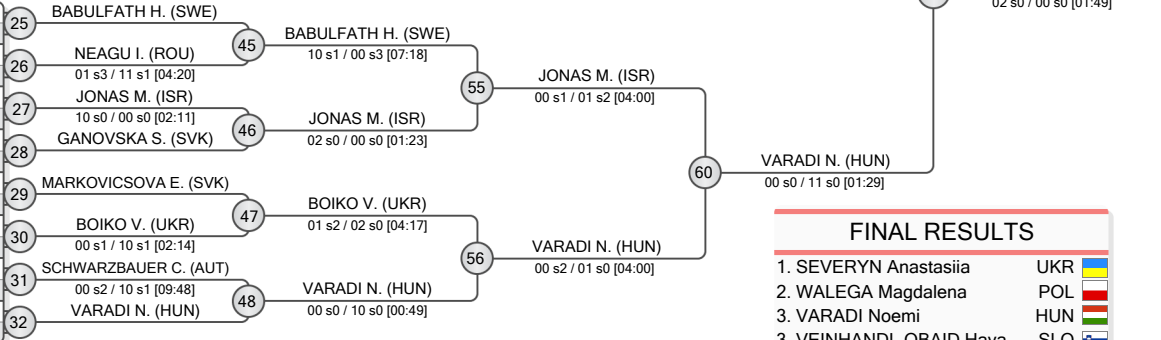

FINAL RESULTS		
1.	SEVERYN Anastasiia	UKR
2.	WALEGA Magdalena	POL
3.	VARADI Noemi	HUN
4.	VEINHANDL OBAID Haya	SLO
5.	JUTTNER Janka	HUN
6.	BOZSO Zita	HUN
7.	JANUSZ Urszula	POL
8.	SCHWARZBAUER Carina	AUT

REPECHAGE

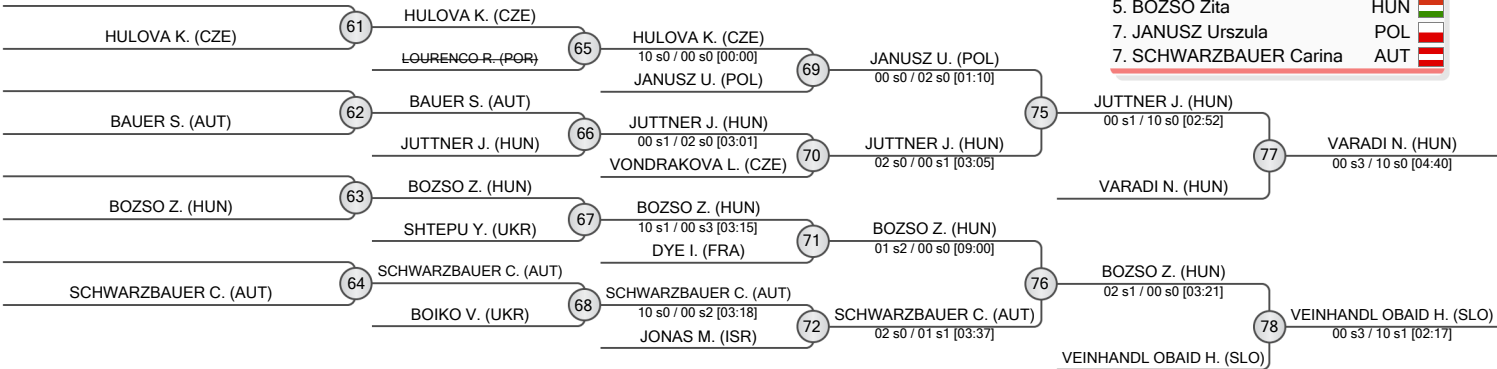



Gyor Cadet European Cup 2024

Hungary, Gyor, 9-10 Nov 2024

-63 kg

Women (43)

POOL A

OPANASENKO Kristina	UKR	1	OPANASENKO K. (UKR)	33	OPANASENKO K. (UKR)
TAKACS Sara	HUN	2	WATROBA D. (POL)	00 s1 / 11 s0 [02:04]	10 s0 / 00 s0 [00:41]
WATROBA Dominika	POL	2	00 s1 / 11 s0 [02:04]		
SCERBOVA Amalie	CZE	3	SCERBOVA A. (CZE)	02 s0 / 00 s0 [01:22]	SKILJEVIC A. (BIH)
KUBA Amalia	ROU	3	02 s0 / 00 s0 [01:22]		00 s2 / 02 s1 [03:07]
SKILJEVIC Ana	BIH	4	SKILJEVIC A. (BIH)	00 s2 / 02 s1 [03:07]	
KORDEL Mira	SWE	5	KORDEL M. (SWE)		
BACHLER Anna	AUT	6	DRDAKOVA M. (SVK)	00 s0 / 02 s2 [02:39]	KORDEL M. (SWE)
DRDAKOVA Martina	SVK	6	00 s0 / 02 s2 [02:39]		10 s0 / 00 s0 [02:31]
TOTH Emma	HUN	7	TOTH E. (HUN)		
COHEN Maayane Jeny Esther	ISR	8	COHEN M. (ISR)	10 s1 / 00 s0 [02:07]	TOTH E. (HUN)
					10 s1 / 00 s0 [02:07]

POOL B

SADILKOVA Zuzana	CZE	9	SADILKOVA Z. (CZE)	37	SADILKOVA Z. (CZE)
FROSONI Giorgia	ITA	10	FROSONI G. (ITA)	10 s2 / 00 s0 [03:32]	SKILJEVIC A. (BIH)
CHRISAKI Anni-Iris	GRE	11	CHRISAKI A. (GRE)	10 s0 / 01 s0 [01:13]	01 s0 / 02 s1 [03:26]
PUKHOVA Polina	ISR	11	10 s0 / 01 s0 [01:13]		
DUDA Julia	POL	12	DUDA J. (POL)	10 s0 / 00 s0 [03:39]	SKILJEVIC A. (BIH)
PAVLOVIC Nevena	SRB	13	PAVLOVIC N. (SRB)		11 s1 / 00 s0 [03:31]
KERTAI Kira	HUN	14	IMERI S. (CRO)	00 s0 / 02 s0 [01:03]	
IMERI Sara	CRO	14	00 s0 / 02 s0 [01:03]		
ELBAZ Shani	ISR	15	ADAMACHI M. (ROU)	00 s0 / 10 s1 [03:25]	KORDEL M. (SWE)
ADAMACHI Maya	ROU	15	00 s0 / 10 s1 [03:25]		10 s0 / 00 s0 [01:31]
SAMOILIU D. Diana	UKR	16	SAMOILIU D. (UKR)	00 s0 / 10 s0 [00:18]	TOTH E. (HUN)
					10 s1 / 00 s0 [02:07]

POOL C

BOB Isabel	ROU	17	BOB I. (ROU)	41	BOB I. (ROU)
YERMIAHU Mai	ISR	18	YERMIAHU M. (ISR)	10 s2 / 00 s3 [05:24]	SKILJEVIC A. (BIH)
PAPASTERGIOU Anna	GRE	18	10 s2 / 00 s3 [05:24]		01 s0 / 02 s1 [03:26]
SISKOVA Stela	CZE	19	KOMODOWSKI I. (DEN)	00 s0 / 10 s0 [02:19]	SKILJEVIC A. (BIH)
KOMODOWSKI Ingrid	DEN	19	00 s0 / 10 s0 [02:19]		00 s2 / 01 s0 [04:00]
IMERI Esra	CRO	20	IMERI E. (CRO)	02 s0 / 00 s0 [01:23]	SKILJEVIC A. (BIH)
MATUSZEKOVA Paula	SVK	21	MATUSZEKOVA P. (SVK)		00 s0 / 02 s0 [03:38]
ZIVANOVIC Tijana	SRB	22	ZIVANOVIC T. (SRB)	10 s0 / 00 s0 [00:54]	SKILJEVIC A. (BIH)
TOROK Csenge	HUN	23	TOROK C. (HUN)	02 s0 / 00 s0 [03:09]	SKILJEVIC A. (BIH)
NAGY Csilla	ROU	23	02 s0 / 00 s0 [03:09]		00 s0 / 10 s0 [00:18]
SOTNYK Viktoriia	UKR	24	SOTNYK V. (UKR)	10 s0 / 00 s3 [04:14]	SKILJEVIC A. (BIH)
					00 s0 / 10 s0 [00:18]

POOL D

WOZNICZKO Nadia	POL	25	WOZNICZKO N. (POL)	45	WOZNICZKO N. (POL)
UNGUREANU Bianca	ROU	26	UNGUREANU B. (ROU)	01 s0 / 00 s1 [04:57]	WOZNICZKO N. (POL)
PINTER Julia	HUN	26	01 s0 / 00 s1 [04:57]		11 s0 / 00 s1 [01:34]
ANDRIC Nina	SRB	27	ANDRIC N. (SRB)	02 s1 / 00 s0 [03:27]	WOZNICZKO N. (POL)
SKERYTE Ugne	LTU	28	SKERYTE U. (LTU)	02 s0 / 00 s0 [00:35]	WOZNICZKO N. (POL)
TATAJ Julia	POL	29	TATAJ J. (POL)		11 s0 / 00 s2 [06:06]
BADASH Naama	ISR	30	BADASH N. (ISR)	02 s0 / 00 s0 [00:49]	WOZNICZKO N. (POL)
PETERSON Ebba	SWE	31	BABJAKOVA V. (SVK)	00 s0 / 02 s0 [00:37]	WOZNICZKO N. (POL)
BABJAKOVA Viktoria	SVK	31	00 s0 / 02 s0 [00:37]		10 s0 / 00 s3 [04:42]
RAMA Bleona	AUT	32	RAMA B. (AUT)	00 s0 / 10 s0 [01:11]	WOZNICZKO N. (POL)
					10 s0 / 00 s3 [04:42]

REPECHAGE

SCERBOVA A. (CZE)	61	SCERBOVA A. (CZE)	65	SCERBOVA A. (CZE)	69	SCERBOVA A. (CZE)
ADAMACHI M. (ROU)	62	ADAMACHI M. (ROU)	66	PAVLOVIC N. (SRB)	70	PAVLOVIC N. (SRB)
ZIVANOVIC T. (SRB)	63	ZIVANOVIC T. (SRB)	67	00 s1 / 01 s0 [04:00]	71	PAVLOVIC N. (SRB)
UNGUREANU B. (ROU)	64	UNGUREANU B. (ROU)	68	00 s1 / 01 s0 [04:00]	72	PAVLOVIC N. (SRB)
				11 s0 / 01 s1 [02:56]	73	PAVLOVIC N. (SRB)
				10 s1 / 00 s2 [02:58]	74	PAVLOVIC N. (SRB)
				00 s3 / 10 s1 [04:39]	75	PAVLOVIC N. (SRB)
				11 s0 / 00 s0 [03:49]	76	PAVLOVIC N. (SRB)
				01 s1 / 02 s1 [02:28]	77	PAVLOVIC N. (SRB)
				10 s0 / 00 s1 [01:44]	78	PAVLOVIC N. (SRB)

73	SAMOILIU D. (UKR)	01 s2 / 02 s1 [05:26]
74	WOZNICZKO N. (POL)	00 s2 / 02 s0 [02:16]
75	WOZNICZKO N. (POL)	00 s1 / 10 s1 [02:57]
76	WOZNICZKO N. (POL)	10 s0 / 00 s3 [04:42]
77	PAVLOVIC N. (SRB)	00 s1 / 01 s2 [05:51]
78	SKILJEVIC A. (BIH)	01 s1 / 02 s1 [02:54]
79	WOZNICZKO N. (POL)	00 s2 / 02 s0 [02:16]

FINAL RESULTS

1.	WOZNICZKO Nadia	POL	
2.	SAMOILIU Diana	UKR	
3.	PAVLOVIC Nevena	SRB	
3.	SKILJEVIC Ana	BIH	
5.	MATUSZEKOVA Paula	SVK	
5.	ANDRIC Nina	SRB	
7.	SCERBOVA Amalie	CZE	
7.	ZIVANOVIC Tijana	SRB	



Gyor Cadet European Cup 2024

Hungary, Gyor, 9-10 Nov 2024

-70 kg

Women (29)

POOL A

	RULLIER Lucie	FRA
	WOEGERER Selina	AUT
	STALIONYTE Paulina	LTU
	HUDIKA Vita	CRO
	EICHMULLER Boglarka	HUN
	JURCIKOVA Viktorie	CZE
	FEHER Zara	ROU

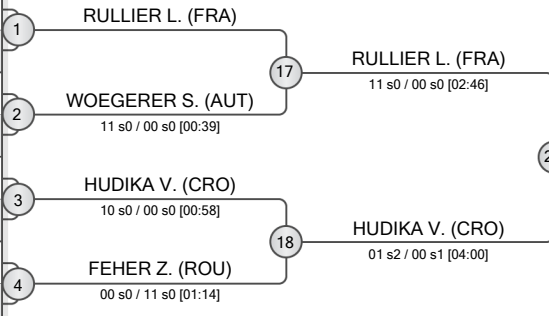

POOL B

	USURELU Alexia	ROU
	PAVIC Lucia	SRB
	BOTOS Lujza	HUN
	PARTLIC Julija	SLO
	OLSZEWSKA Kinga	POL
	SUCIU Anamaria	ROU
	KIRALY Regina	HUN
	SMILJIC Anja	BIH

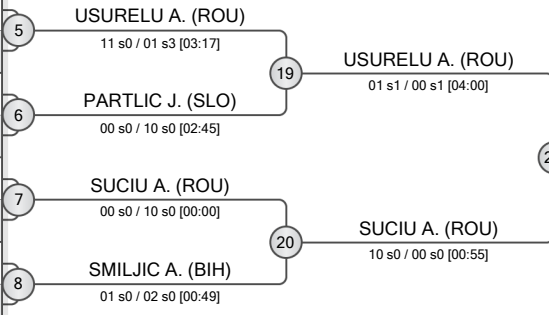

POOL C

	MCHENRY Hannah	AUS
	PANOVICS Hanga	HUN
	BOGDAN Smaranda	ROU
	KRUPL Georgina	HUN
	DOVHUN Yana	UKR
	MENANTEAU Jeanne	FRA
	BAUMANN Rosalie	AUT

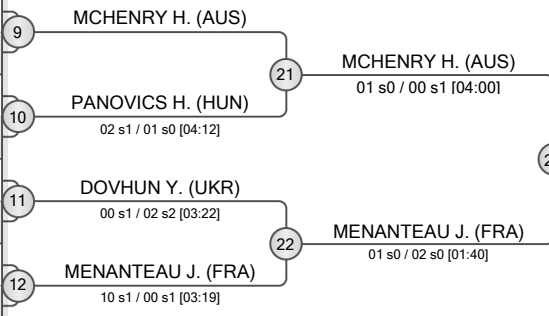

POOL D

	SARKOZI Zsuzsa	HUN
	JOHANSSON Ronja	SWE
	EHMSEN Karen	DEN
	ZYS Rokšana	POL
	DUDAS Cezara	ROU
	BESKER Ana	CRO
	CSISZAR Kincso	HUN

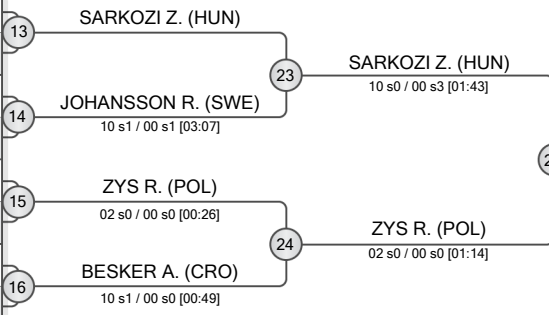

REPECHAGE

WOEGERER S. (AUT)	29	WOEGERER S. (AUT)
PAVIC L. (SRB)	30	PAVIC L. (SRB)
PARTLIC J. (SLO)	30	PARTLIC J. (SLO)
BAUMANN R. (AUT)	31	DOVHUN Y. (UKR)
DOVHUN Y. (UKR)	31	DOVHUN Y. (UKR)
DUDAS C. (ROU)	32	BESKER A. (CRO)
BESKER A. (CRO)	32	BESKER A. (CRO)

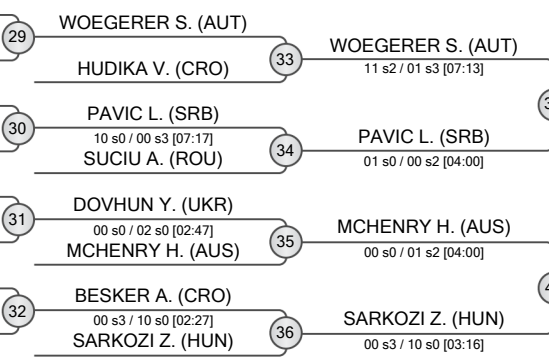

FINAL RESULTS		
1.	RULLIER Lucie	FRA
2.	ZYS Rokšana	POL
3.	MENANTEAU Jeanne	FRA
4.	USURELU Alexia	ROU
5.	WOEGERER Selina	AUT
6.	PAVIC Lucia	SRB
7.	MCHENRY Hannah	AUS



Gyor Cadet European Cup 2024

Hungary, Gyor, 9-10 Nov 2024

+ 70 kg

Women (14)

POOL A

	FEUILLET--NGUIMGO Emma	FRA
	COCIORBA Ioana	ROU
	HOELLWART Michaela	AUT

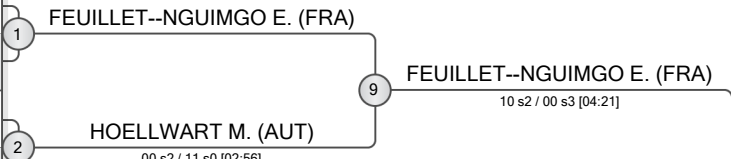

POOL B

	FILKOROVA Nina	SVK
	KOCIEBA Aleksandra	POL
	RADAKOVIC Milica	SRB
	SOTSKA Tetiana	UKR

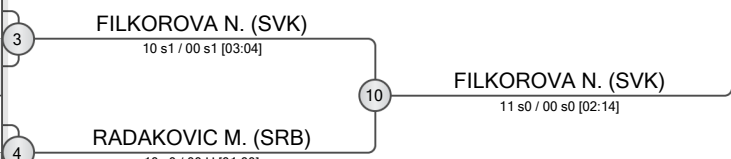

POOL C

	TROKA Julia	POL
	HEURTEAU Bleuene	FRA
	KERTESZ Livia	HUN

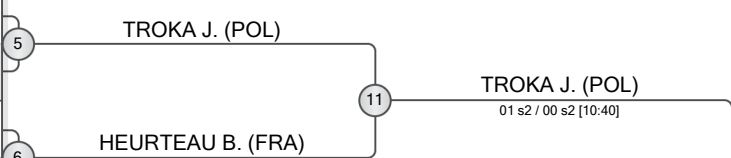

POOL D

	ZAREBA Nikola	POL
	PODZEMNA Zuzana	CZE
	EININGE Saule	LTU
	KHIMCHYK Myroslava	UKR

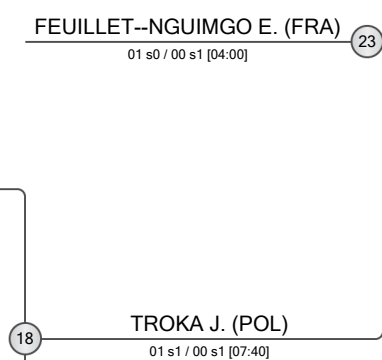
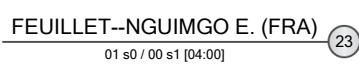
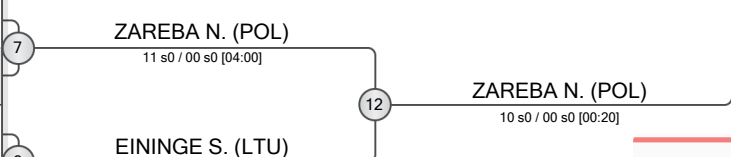

REPECHAGE

13	HOELLWART M. (AUT)
14	KOCIEBA A. (POL)
15	HEURTEAU B. (FRA)
16	PODZEMNA Z. (CZE)
17	FEUILLET--NGUIMGO E. (FRA)
18	TROKA J. (POL)
19	HOELLWART M. (AUT)
20	HEURTEAU B. (FRA)
21	HOELLWART M. (AUT)
22	FILKOROVA N. (SVK)

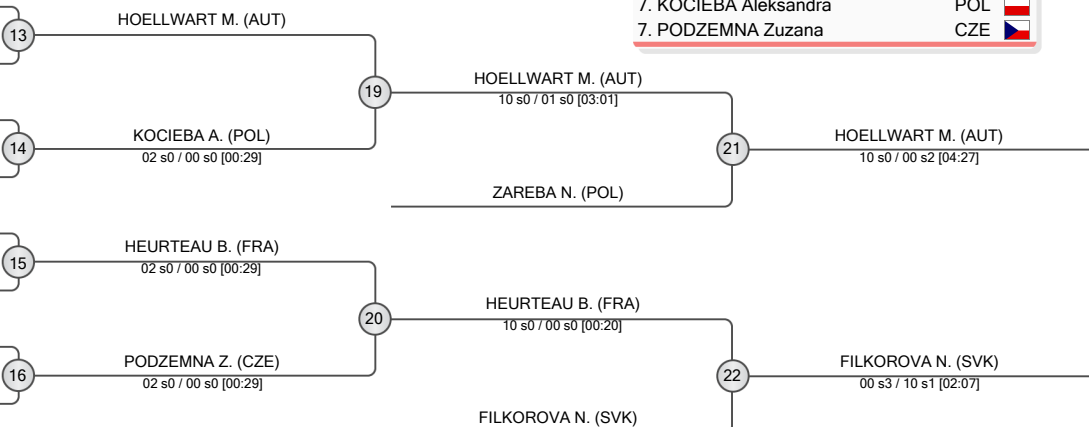

FINAL RESULTS		
1.	FEUILLET--NGUIMGO Emma	FRA
2.	TROKA Julia	POL
3.	HOELLWART Michaela	AUT
3.	FILKOROVA Nina	SVK
5.	ZAREBA Nikola	POL
5.	HEURTEAU Bleuene	FRA
7.	KOCIEBA Aleksandra	POL
7.	PODZEMNA Zuzana	CZE