



Poznan Junior European Cup 2024

Poland, Poznan, 13-14 Apr 2024

-60 kg

Men (32)

POOL A

	ORYNBASSAR Talgat	KAZ
	DRESE Leonas	GER
	ZACHA Viktor	CZE
	GAJCY Nikodem	POL
	DEMPSEY Ross	GBR
	KIM Serhii	UKR
	WELLENS Mattias	BEL
	TOMANEK Jozef	SVK

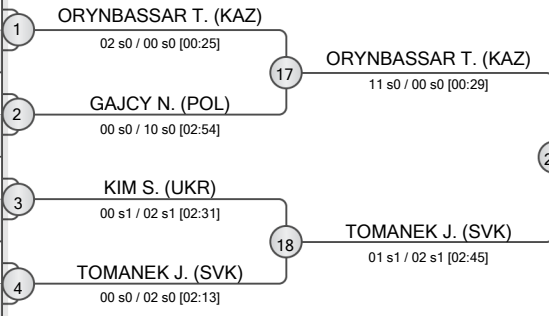

POOL B

	PIECHOTA Stanislaw	POL
	AVRAMENKO Danylo	UKR
	SHCHEKOTIN Filipp	EST
	KULUSHEV Daniyar	KAZ
	SIMONOV Yeroslav	ISR
	KUROWSKI Jakub	POL
	CABECANA Luke	GER
	WALINGA Ruben	NED

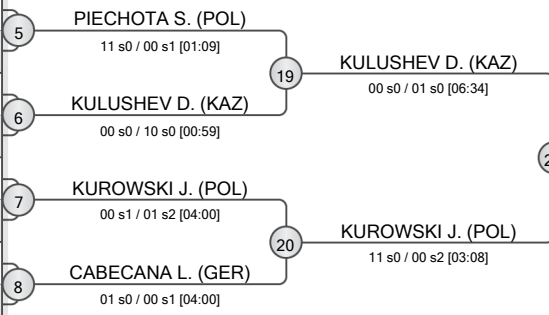

POOL C

	IGNASIAK Ksawery	POL
	SERIKOV Madi	KAZ
	RICHTER Arjan	GER
	VOVK Anton	UKR
	RUZA Lukas	CZE
	BIEDRZYCKI Hubert	POL
	MIRIJEV Farhad	EST
	MIDDLETON Vas	AUS

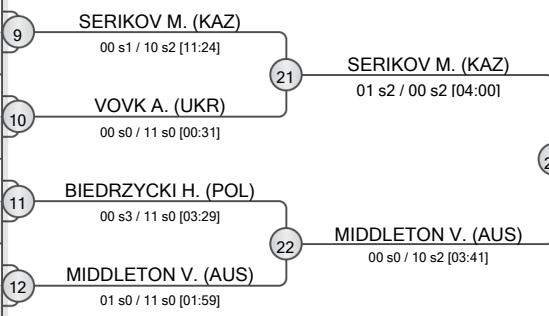

POOL D

	KARGULOV Aldiyar	KAZ
	MARCHEL Aleksander	POL
	LOEFFLER Kilian	GER
	WALKER Samuel	GBR
	KUTSCHER Nicolas	GER
	RUBINSTEIN Roy	ISR
	CLARK Peter	EST
	DZHAMALDINOV Amsar	BEL

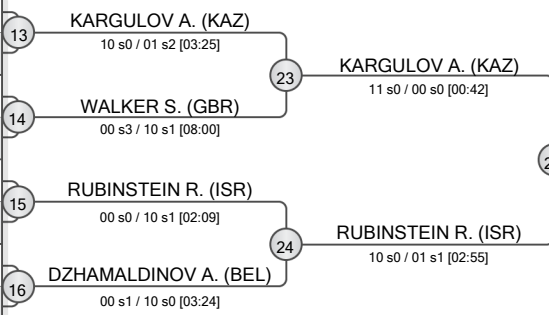

REPECHAGE

	DRESE L. (GER)	
29	GAJCY N. (POL)	
	SIMONOV Y. (ISR)	
30	CABECANA L. (GER)	
	MIRIJEV F. (EST)	
31	BIEDRZYCKI H. (POL)	
	MARCHEL A. (POL)	
32	WALKER S. (GBR)	

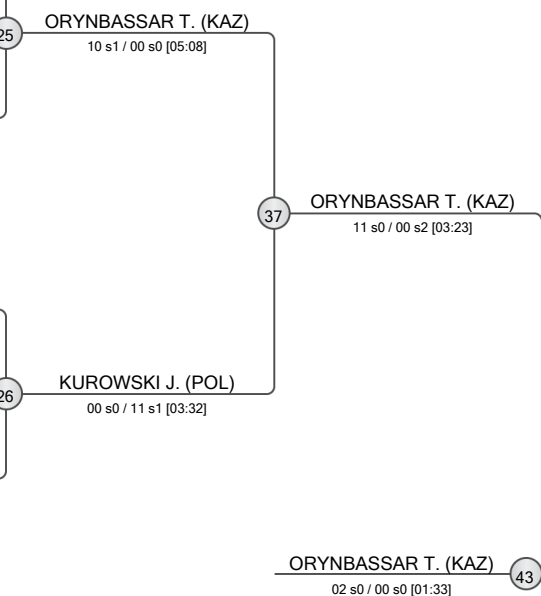
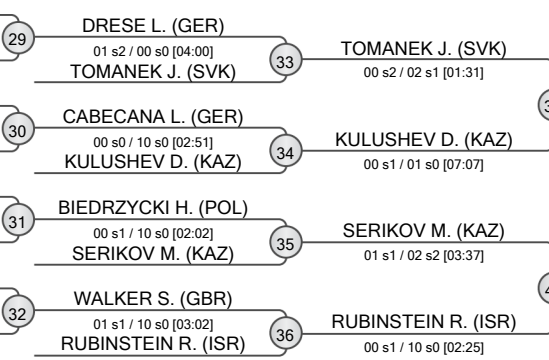

FINAL RESULTS	
1.	ORYNBASSAR Talgat KAZ
2.	KARGULOV Aldiyar KAZ
3.	MIDDLETON Vas AUS
3.	KUROWSKI Jakub POL
5.	KULUSHEV Daniyar KAZ
5.	SERIKOV Madi KAZ
7.	TOMANEK Jozef SVK
7.	RUBINSTEIN Roy ISR





Poznan Junior European Cup 2024

Poland, Poznan, 13-14 Apr 2024

-66 kg

Men (49)

POOL A

	VAN HARTEN Jochem	NED
	SZATMARI Mark	CZE
	BAKYTOV Dossymzhan	KAZ
	STEFANSKI Adrian	POL
	BOLZAN Nikita	LTU
	BALIEV Ramzan	GER
	SHERER Ziv	ISR
	JAKIMOV Edward	EST
	PIATKOWSKI Adam	POL
	MASLAC Rajko	SVK
	ROMAS Denys	UKR
	EMMERLING Anton	GER

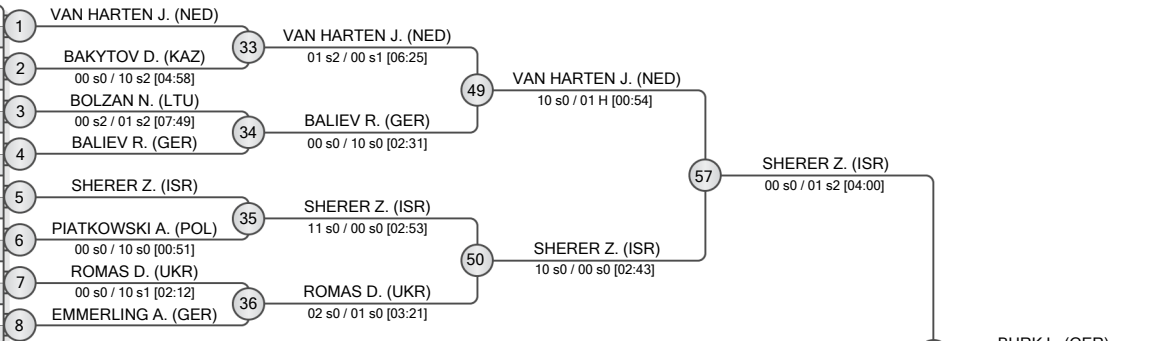

POOL B

	SHEYNFELD Lenny	USA
	KOVALOV Vadym	UKR
	KORNATKA Kacper	POL
	DEKAN Roman	SVK
	BAIKENZHEYEV Ayan	KAZ
	BURK Lenny Linus	GER
	TOURNIER Timeo	AUS
	HURSKAINEN Perttu	FIN
	ZDANOWSKI Eryk	POL
	BEN SAAD Firas	AUT
	DUBINA Hlib	UKR
	VELSTRA Sil	NED

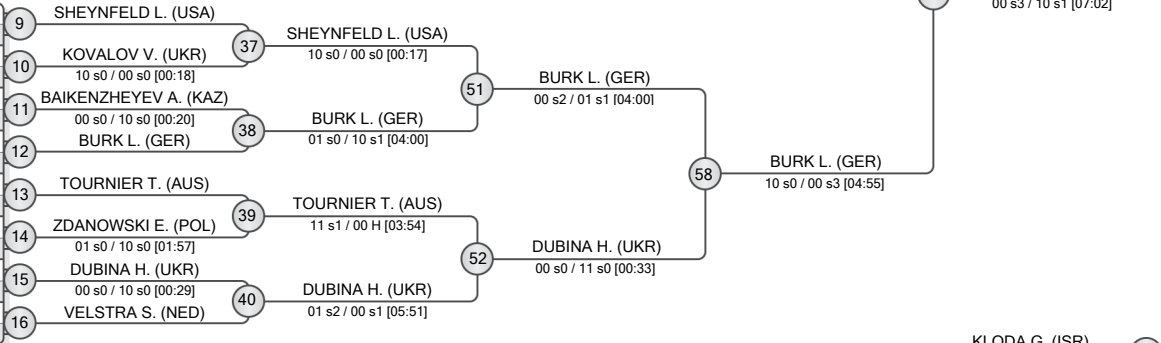

POOL C

	SCHMIDT Noel	GER
	DERKACZ Marcel	POL
	KRAVCHENKO Danylo	UKR
	LAVI Ori	ISR
	POLIKEVICIUS Simas	LTU
	BAJTOS Jakub	SVK
	SIMOENS Xander	BEL
	KAMINSKY A. (UKR)	UKR
	JANSEN Zef	NED
	YERZHANOV Yerasyl	KAZ
	TSUKANOV Nazar	POL
	NOVIKOV Jegor	EST

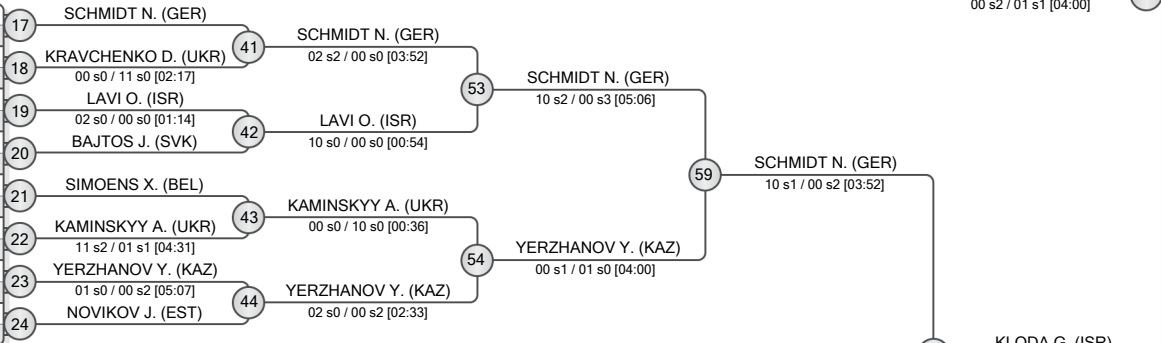

POOL D

	ZHUBATKANOV Akylzhan	KAZ
	TOSZEGI Adam	GER
	FITYKA Mateusz	POL
	JAKIMOV Robert	EST
	NIEMENKARI Kasper	FIN
	BETKOWSKI Milosz	POL
	SOROCHAN Artem	UKR
	BLUHME Alexander	AUT
	KITAGAWA Alexander	GER
	VREELING Tristan	NED
	SZOPA Mikolaj	POL
	JOST Kimi	AUS
	KLODA Gal	ISR

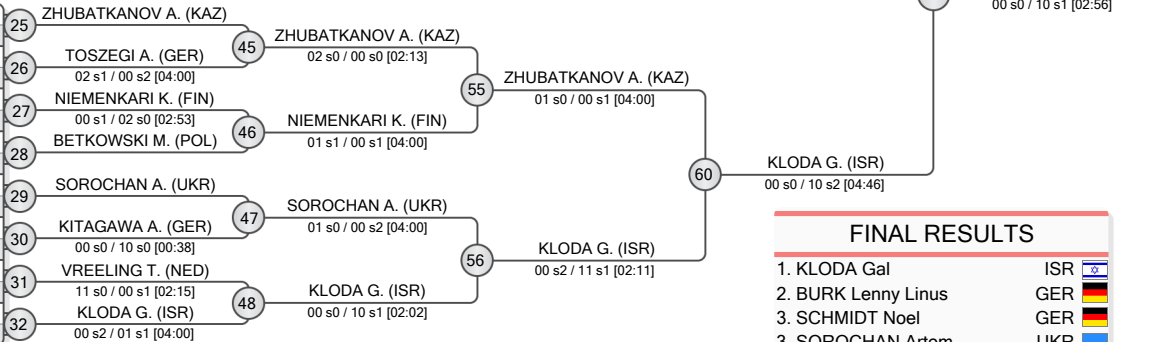

FINAL RESULTS		
1.	KLODA Gal	ISR
2.	BURK Lenny Linus	GER
3.	SCHMIDT Noel	GER
3.	SOROCHAN Artem	UKR
5.	VAN HARTEN Jochem	NED
5.	SHERER Ziv	ISR
7.	DUBINA Hlib	UKR
7.	KRAVCHENKO Danylo	UKR

REPECHAGE

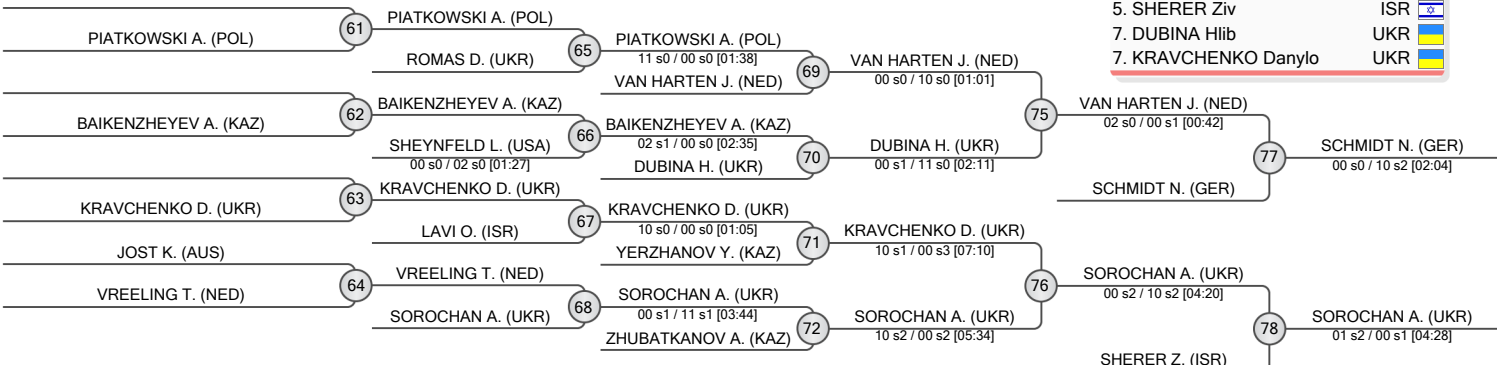



Poznan Junior European Cup 2024

Poland, Poznan, 13-14 Apr 2024

-73 kg

Men (60)

POOL A

ALMAT Adilet	KAZ
MURAWSKI Maximilian	GER
FISER Stepan	CZE
ABDULLAEV Abdusamad	GER
CRAMP Thomas	AUS
MORITZ Ohad	ISR
JAGIELSKI Aleksander	POL
NEUMANN Eryk	GBR
COENE Daan	BEL
IVTCHENKO Josef	GER
WIWATOWSKI Bartosz	POL
MIRIJEV Paerviz	EST
FEDORYK Danylo	UKR
KIVELAE Ville	FIN
LIWOCHA Krystian	GER

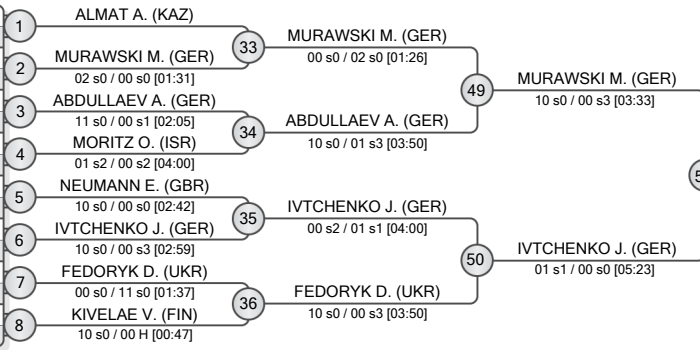

POOL B

DOKTOROV Denys	UKR
STROMBERGER Alexander	GER
URO Lenni	FIN
ZHAKASHOV Aibek	KAZ
JAREMKO Kamil	POL
JACKSON Thomas	GBR
BULINGER Eduard	GER
VAN DER VEEN Quinten	NED
KASERER Alexander	AUT
SHAHBERDIAN Gianni	BEL
HUEPENBECKER Louis	GER
KUCZYNSKI Jakub	POL
LYSENKO Vladyslav	UKR
JOVSA Deividas	LTU
AKOTO Raphael	GER

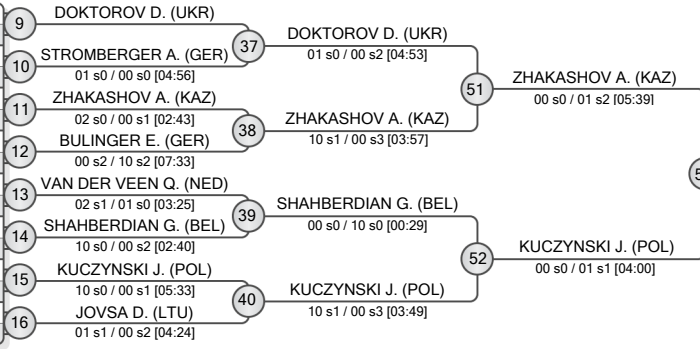

POOL C

GAZALOEV Mouhammad	BEL
VON LEUPOLDT Leonhard	GER
DIKAJEV Saad	EST
JOHANEK David	CZE
AKOPJAN Arthur	GER
MAMINSKI Konrad	POL
RANKINEN Jere	FIN
FRIDMAN ZILBERSTEIN Reem	ISR
BUECH Sebastian	GER
DOVICIC Tomas	SVK
DAVIES Peter	GBR
KRAWCZYK Bartosz	POL
KHALIDOV Said-Magomed	UKR
WEEDE Luca	GER
KENESKAN Yernar	KAZ

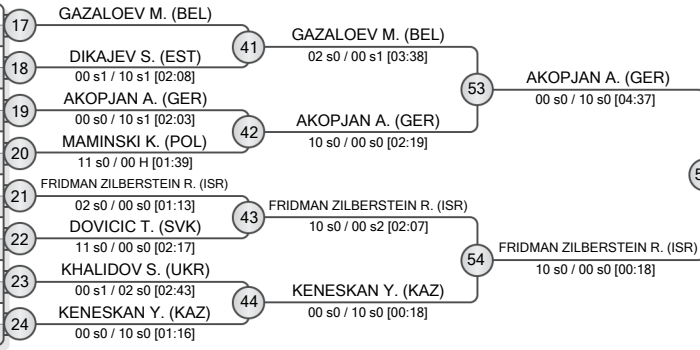

POOL D

GOSPODINOV Dimitar	BUL
CALINSKI Aleksy	POL
TINKOCZY Matyas	NED
MIESENBERGER Martin	AUT
GUENTHER Nouri	GER
KRYL Jan	CZE
DAVID Hugo	FRA
KAZIMIERCZAK Adam	POL
YOSUL Can Ilias	GER
TAAVITSAINEN Jesper	FIN
MARINX Ray	BEL
SZULIK Szymon	POL
REDDIG Finn Luka	GER
HEFFERNAN Eden	GBR
LEKISHVILI Heorhii	UKR

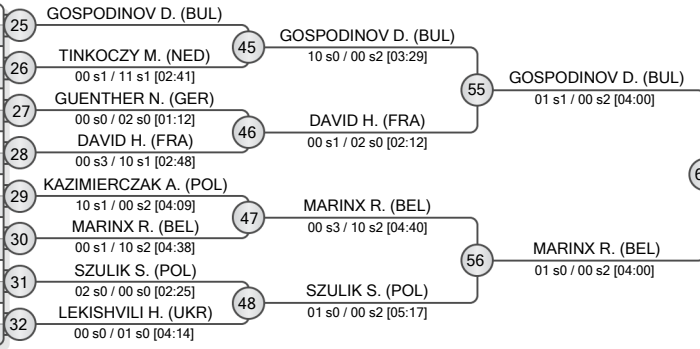

REPECHAGE

WIWATOWSKI B. (POL)	61	NEUMANN E. (GBR)	65	FEDORYK D. (UKR)
NEUMANN E. (GBR)	62	FEDORYK D. (UKR)	66	MURAWSKI M. (GER)
JAREMKO K. (POL)	63	BULINGER E. (GER)	67	MURAWSKI M. (GER)
BULINGER E. (GER)	64	DOKTOROV D. (UKR)	68	KUCZYNSKI J. (POL)
BUECH S. (GER)		BUECH S. (GER)		KUCZYNSKI J. (POL)
DOVICIC T. (SVK)		KENESKAN Y. (KAZ)		AKOPJAN A. (GER)
TAAVITSAINEN J. (FIN)		AKOPJAN A. (GER)		AKOPJAN A. (GER)
KAZIMIERCZAK A. (POL)		SZULIK S. (POL)		SZULIK S. (POL)
		SZULIK S. (POL)		GOSPODINOV D. (BUL)

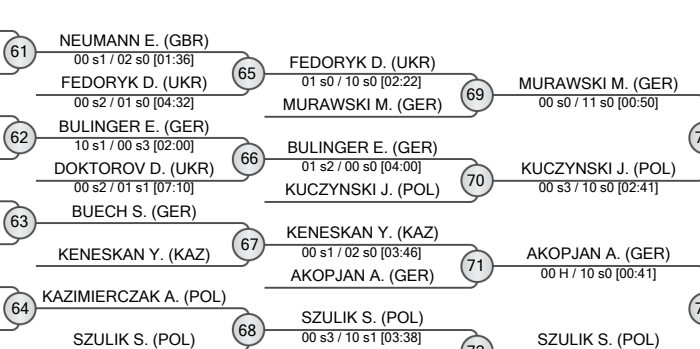

FINAL RESULTS		
1.	FRIDMAN ZILBERSTEIN Reem	ISR
2.	ZHAKASHOV Aibek	KAZ
3.	MARINX Ray	BEL
4.	AKOPJAN Arthur	GER
5.	MURAWSKI Maximilian	GER
6.	IVTCHENKO Josef	GER
7.	KUCZYNSKI Jakub	POL
8.	SZULIK Szymon	POL





Poznan Junior European Cup 2024

Poland, Poznan, 13-14 Apr 2024

-81 kg

Men (42)

POOL A

KUMISBAY Azat	KAZ	1	KUMISBAY A. (KAZ)	33	KUMISBAY A. (KAZ)
GOEBEL Matti	GER	2	LEPIANKA B. (POL)	01 H / 10 s0 [02:35]	10 s0 / 00 H [00:26]
LEPIANKA Bartosz	POL	3	ARATEN S. (ISR)	34	ARATEN S. (ISR)
ARATEN Shahar	ISR	4	NARKUS V. (LTU)	34	10 s0 / 00 s0 [00:20]
NARKUS Vygidras	LTU	5	EAMES B. (AUS)	35	EAMES B. (AUS)
EAMES Bailey	AUS	6	BORYSIK K. (POL)	35	10 s0 / 01 s0 [01:53]
BORYSIK Konrad	POL	7	MAERKT E. (GER)	36	MAERKT E. (GER)
MAERKT Elija Ruben	GER	8	PRYBYSHENIA I. (UKR)	36	01 s2 / 00 s0 [04:00]
PROELL Michael	AUT				02 s0 / 00 s1 [02:30]
PRYBYSHENIA Illia	UKR				

POOL B

NASCHCHO Issa	AUT	9	NASCHCHO I. (AUT)	37	NASCHCHO I. (AUT)
BOUATIA Kamil	POL	10	KAUN S. (GER)	37	02 s0 / 00 s0 [03:11]
KAUN Sebastian	GER	11	KRYLOV D. (KAZ)	38	KRYLOV D. (KAZ)
KRYLOV Danil	KAZ	12	KRAUSS J. (POL)	38	02 s0 / 00 s0 [02:11]
KRAUSS Jan	POL	13	TARKOWSKI F. (POL)	39	TARKOWSKI F. (POL)
TARKOWSKI Fabrycius	POL	14	HASSOUN A. (BEL)	39	11 s0 / 00 s0 [01:38]
OHNEISER Lukas	GER	15	KHAKIMOV M. (UKR)	40	00 s2 / 10 s0 [03:13]
HASSOUN Alhamzah	BEL	16	BLIN M. (CZE)	40	01 s1 / 00 s2 [04:30]
KHAKIMOV Mahomed	UKR				10 s0 / 00 s1 [01:11]
HAKANSON Rasmus	SWE				
BLIN Matej	CZE				

POOL C

KORCHEMLIUK Stanislav	UKR	17	KORCHEMLIUK S. (UKR)	41	KESHET HALEVI O. (ISR)
KESHET HALEVI Ori	ISR	18	KESHET HALEVI O. (ISR)	41	00 s0 / 02 s0 [01:30]
SZYPEREK Mateusz	POL	19	VON SCHRADER R. (AUT)	42	10 s0 / 00 s0 [00:09]
BRZUSZCZYNSKI Szymon	POL	20	LEHNIGER J. (GER)	42	10 s1 / 00 s0 [01:14]
VON SCHRADER Ruben	AUT	21	GOLLAND C. (GER)	43	10 s1 / 00 s0 [03:50]
LEHNIGER Joseph	GER	22	NIELZIEV T. (UKR)	43	00 s0 / 02 s0 [03:45]
GOLLAND Caspar	GER	23	HULIN K. (POL)	44	10 s0 / 00 s0 [00:48]
NIELZIEV Taras	UKR	24	JOLKIN N. (EST)	44	00 s1 / 02 s0 [02:37]
POTUCEK Tomas	CZE				
HULIN Kamil	POL				
JOLKIN Nikita	EST				

POOL D

DE LANGE Joshua	NED	25	DE LANGE J. (NED)	45	DE LANGE J. (NED)
SAHIR Stanislav	UKR	26	SAILAUBAY N. (KAZ)	45	10 s0 / 00 s1 [00:36]
SAILAUBAY Nurlan	KAZ	27	KRIZEK S. (CZE)	46	00 s0 / 01 s1 [07:13]
KRIZEK Simon	CZE	28	WATKOWSKI K. (POL)	46	02 s0 / 00 s0 [02:34]
WATKOWSKI Kacper	POL	29	CHRISTIAENS N. (BEL)	47	CHRISTIAENS N. (BEL)
CHRISTIAENS Noah	BEL	30	ZULYS A. (LTU)	47	10 s0 / 00 s0 [01:27]
ZULYS Algirdas	LTU	31	PANEK S. (POL)	48	PANEK S. (POL)
PANEK Szymon	POL	32	KIRK J. (GBR)	48	02 s1 / 00 s0 [02:01]
GINAEV Maik	GER				
KIRK Joseph	GBR				

REPECHAGE

LEPIANKA B. (POL)	61	ARATEN S. (ISR)	65	LEPIANKA B. (POL)	69	MAERKT E. (GER)
HASSOUN A. (BEL)	62	HASSOUN A. (BEL)	66	HASSOUN A. (BEL)	70	MAERKT E. (GER)
GOLLAND C. (GER)	63	KHAKIMOV M. (UKR)	66	NASCHCHO I. (AUT)	70	NASCHCHO I. (AUT)
ZULYS A. (LTU)	64	GOLLAND C. (GER)	67	GOLLAND C. (GER)	71	KESHET HALEVI O. (ISR)
		JOLKIN N. (EST)	67	KESHET HALEVI O. (ISR)	71	KESHET HALEVI O. (ISR)
		ZULYS A. (LTU)	68	PANEK S. (POL)	72	DE LANGE J. (NED)
		PANEK S. (POL)	68	DE LANGE J. (NED)	72	DE LANGE J. (NED)

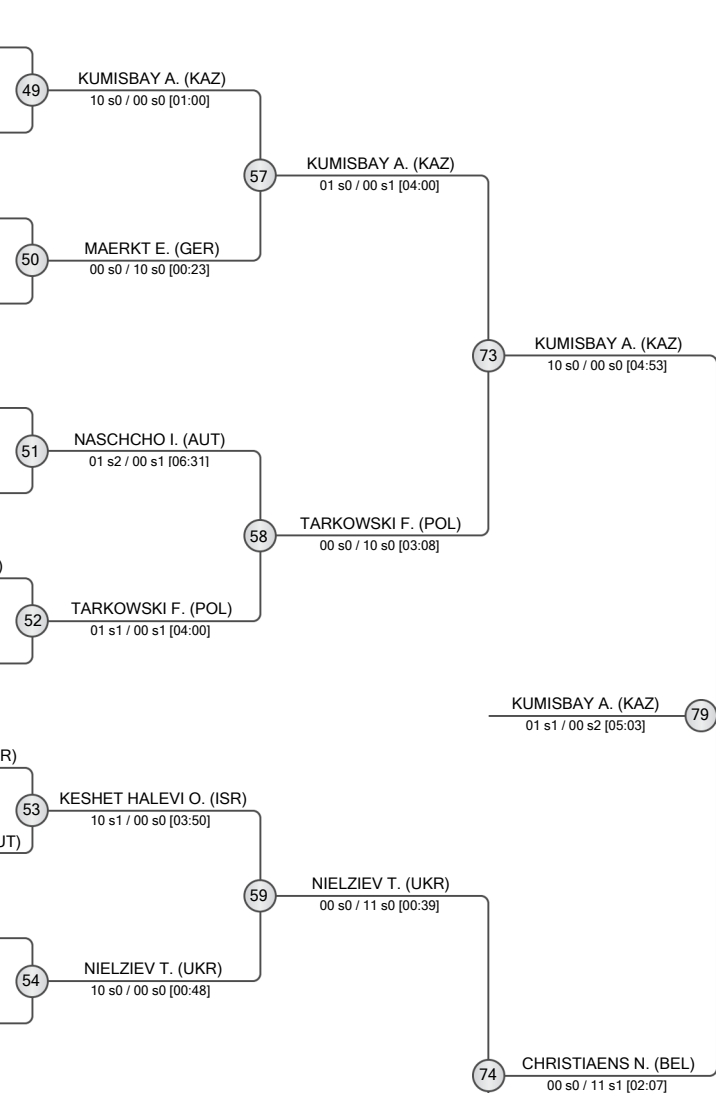

FINAL RESULTS	
1. KUMISBAY Azat	KAZ
2. CHRISTIAENS Noah	BEL
3. NIELZIEV Taras	UKR
3. DE LANGE Joshua	NED
5. NASCHCHO Issa	AUT
5. TARKOWSKI Fabrycius	POL
7. MAERKT Elija Ruben	GER
7. KESHET HALEVI Ori	ISR





Poznan Junior European Cup 2024

Poland, Poznan, 13-14 Apr 2024

-90 kg
Men (35)

POOL A

	CLOETE Ilan	AUS
	HOLTSMEIER Oliver	EST
	WAWRZONEK Jakub	POL
	FOUQUET-PERTUSA Lucas	FRA
	BAALMANS Nijs	NED
	BISENOV Nurzhan	KAZ
	ZIELINSKI Juliusz	POL
	PARSHYN Viacheslav	UKR
	RIEDEL Louis	GER

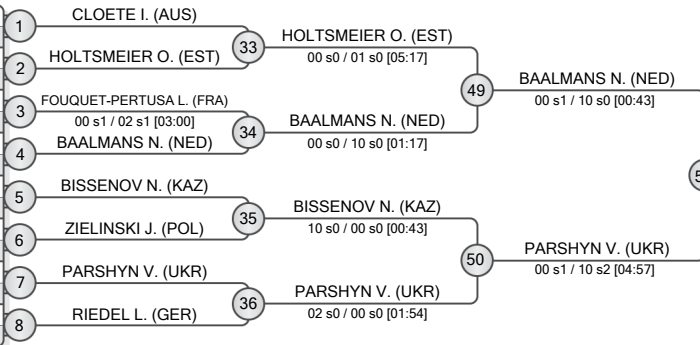

POOL B

	BOLDYRIEV Oleksii	UKR
	DRAG Stanislaw	POL
	SZYMAINSKI Paul	GER
	SCHEFFEL Oliver	SVK
	DEN HARTOG Floris	NED
	ALTYNBAY Aziz	KAZ
	WEITZBAUER Niklas	AUT
	KIELESINSKI Jakub	POL
	PACARIZ Armin	GER

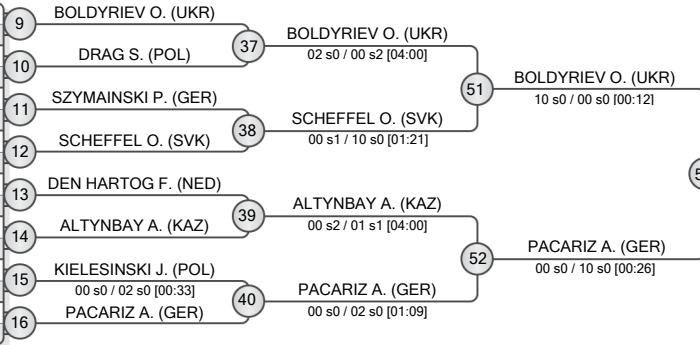

POOL C

	KUTENKOV Ivan	UKR
	STAWINSKI Patryk	POL
	WESTERMARCK Pyry	FIN
	HOF Yehonatan	ISR
	PROELL Ronald	AUT
	ALTAYEV Ulan	KAZ
	GRZESKOWIAK Adam	POL
	KOELBLINGER Marius	GER
	EL GOURARI Ayoub	NED

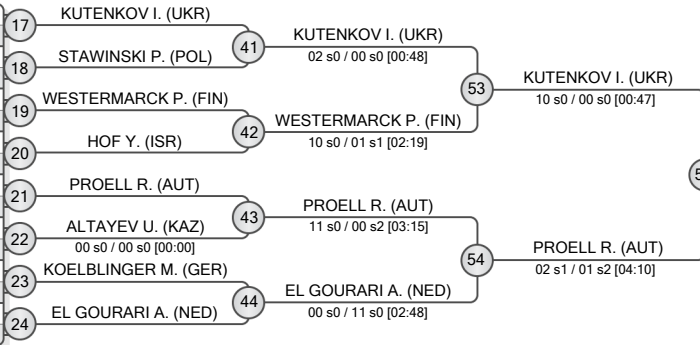

POOL D

	WASIKOWSKI Michal	POL
	OMELCHENKO Bohdan	UKR
	ERLER Maximilian	GER
	BEYERS Carstens	AUS
	RAKOV Yegor	KAZ
	DOL Giel	NED
	VOLKOV Kiril	LTU
	DEMYDENKO Yaroslav	UKR

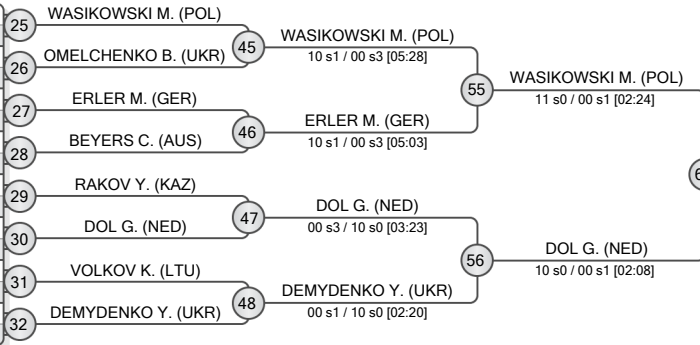

FINAL RESULTS		
1.	PACARIZ Armin	GER
2.	DOL Giel	NED
3.	FOUQUET-PERTUSA Lucas	FRA
4.	KUTENKOV Ivan	UKR
5.	PROELL Ronald	AUT
6.	BAALMANS Nijs	NED
7.	ALTYNBAY Aziz	KAZ
8.	WASIKOWSKI Michal	POL

REPECHAGE

61	FOUQUET-PERTUSA L. (FRA)
62	KIELESINSKI J. (POL)
63	ALTAYEV U. (KAZ)
64	RAKOV Y. (KAZ)

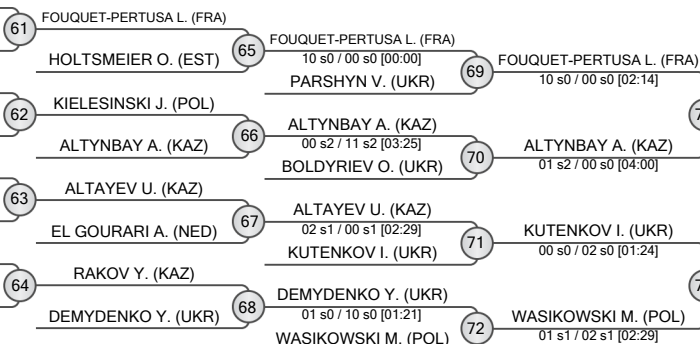



Poznan Junior European Cup 2024

Poland, Poznan, 13-14 Apr 2024

-100 kg
Men (16)

POOL A

	VARES Jakob	EST
	MAHAMEED Vincent	POL
	PECHA Matej	SVK
	FULNECEK Simon	CZE

POOL B

	MOSKVYCH Vladyslav	UKR
	FRANSENS Leonhard	NED
	JESIOLOWSKI Jan	POL
	DUISENBEEK Ramazan	KAZ

POOL C

	KUBIAK Damian	POL
	RISUKHIN Bohdan	UKR
	BASCHIN Jannis	GER
	RAIS Bibarys	KAZ

POOL D

	LHOTZKY Frantisek	CZE
	KRZYNOWEK Oskar	POL
	YUDANOV Nikita	UKR
	KLIMCIAUSKAS Antanas	LTU

REPECHAGE

MAHAMEED V. (POL)	13	FULNECEK S. (CZE)
FULNECEK S. (CZE)		
FRANSENS L. (NED)	14	FRANSENS L. (NED)
DUISENBEEK R. (KAZ)		
RAIS B. (KAZ)	15	KUBIAK D. (POL)
KUBIAK D. (POL)		
KLIMCIAUSKAS A. (LTU)	16	LHOTZKY F. (CZE)
LHOTZKY F. (CZE)		

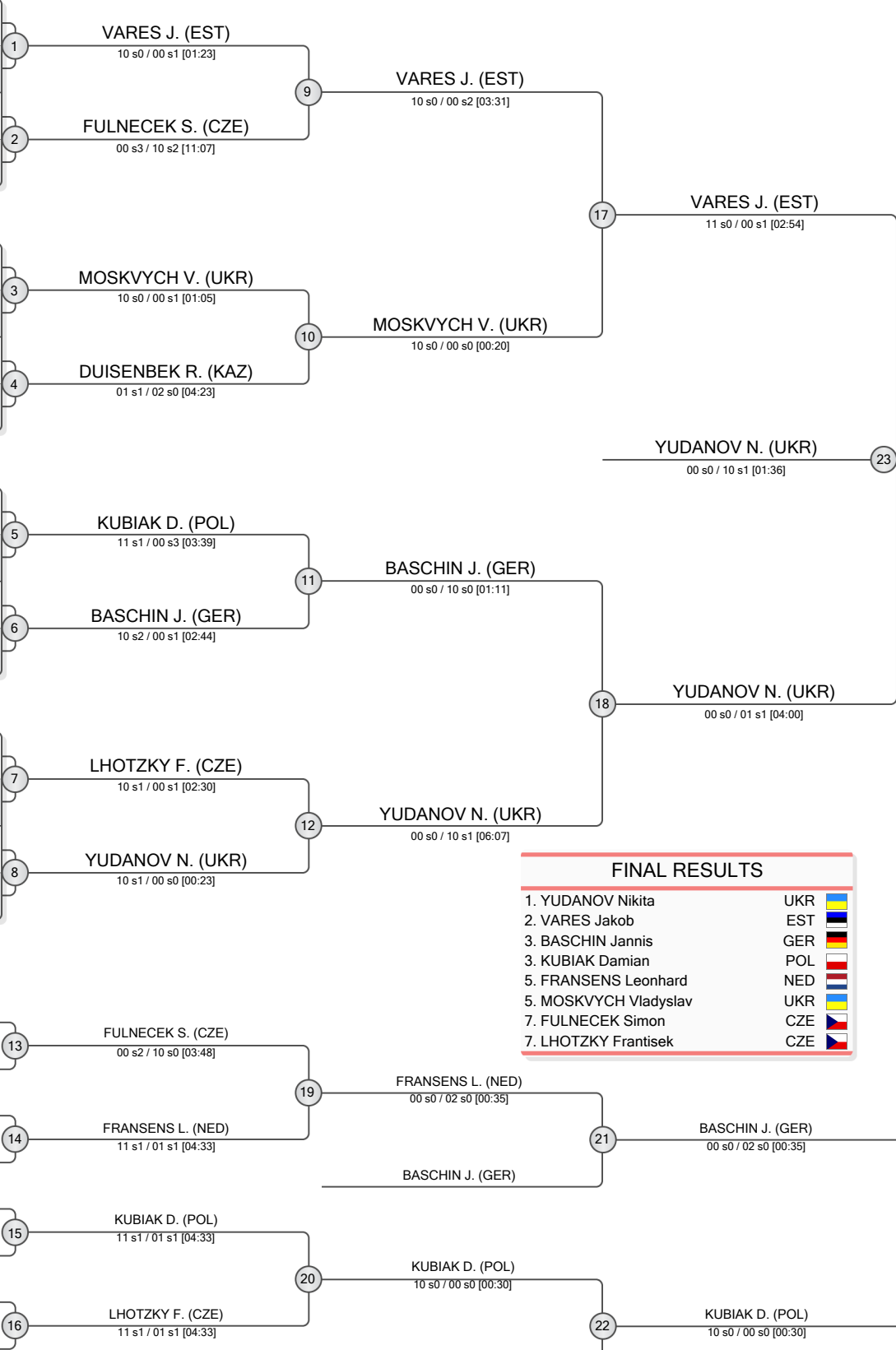



Poznan Junior European Cup 2024

Poland, Poznan, 13-14 Apr 2024

+100 kg

Men (12)

POOL A

	RASKA Tomas	CZE
	DOBRIAN Marcel	POL
	YAROSHENKO Fedir	UKR

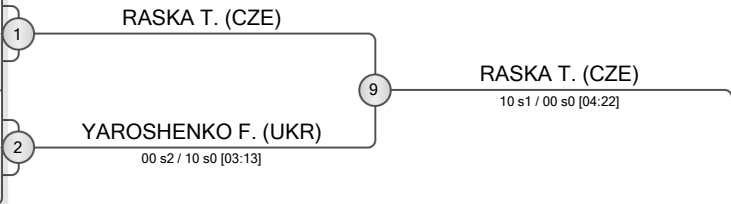

POOL B

	SUHA Mortaza	GER
	NIKITENKO Nikita	GER
	KLOS Milosz	POL

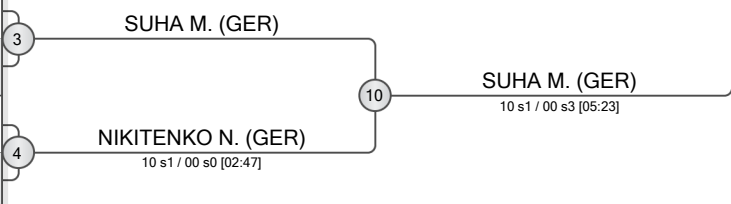

POOL C

	KIRNA Kabriel	EST
	STREMAUSKAS Mykolas	LTU
	SEDLAK Martin	CZE

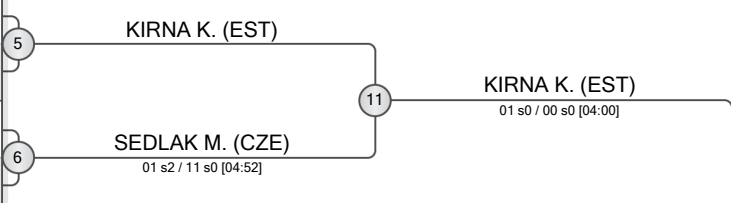

POOL D

	NURTILEPULY Zhantilek	KAZ
	OMELCHENKO Yaroslav	UKR
	CHAMERSKI Daniel	POL

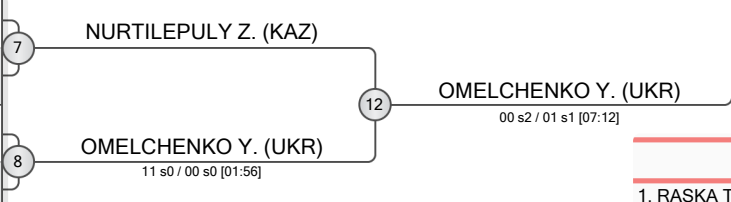

REPECHAGE

13	YAROSHENKO F. (UKR)
14	NIKITENKO N. (GER)
15	SEDLAK M. (CZE)
16	NURTILEPULY Z. (KAZ)

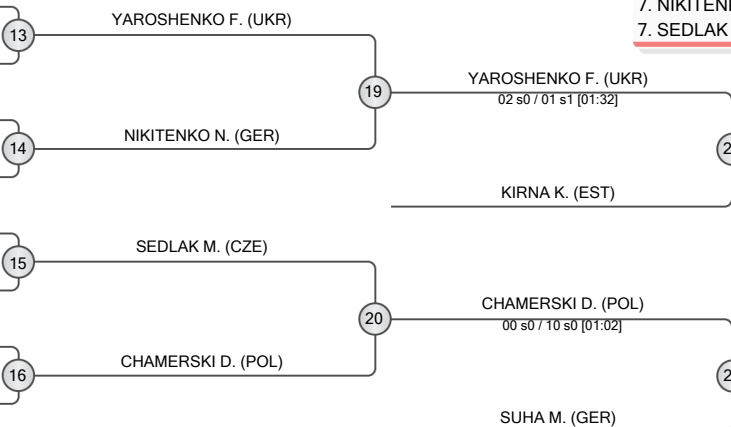

FINAL RESULTS		
1.	RASKA Tomas	CZE
2.	OMELCHENKO Yaroslav	UKR
3.	YAROSHENKO Fedir	UKR
3.	SUHA Mortaza	GER
5.	KIRNA Kabriel	EST
5.	CHAMERSKI Daniel	POL
7.	NIKITENKO Nikita	GER
7.	SEDLAK Martin	CZE





Poznan Junior European Cup 2024

Poland, Poznan, 13-14 Apr 2024

-48 kg

Women (16)

POOL A

	ALIYEVA Konul	AZE
	RIKMANSPOEL Maud	NED
	YULDASHBEKOVA Sabina	KAZ
	GALICKA Natalia	POL

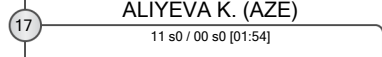
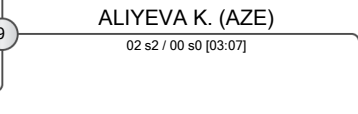

POOL B

	SIBILLE Victoria	BEL
	KUKHAR Milena	UKR
	HENDRIKS Milou	NED
	GHAFFAR Asal	GER

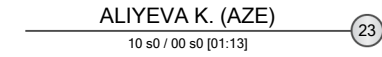
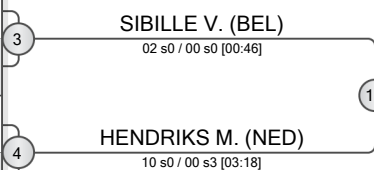

POOL C

	SUPERSON Anastasiia	UKR
	WARNERS Megan	NED
	KOZUCH Oliwia	POL
	LOEHNER Liv Grete	GER

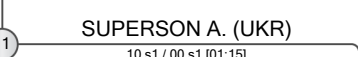
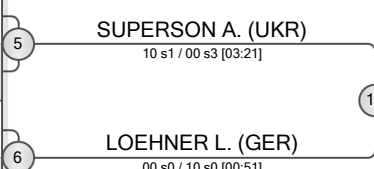

POOL D

	SHAW Summer	GBR
	KORCAKOVA Marketa	CZE
	PEHERSTORFER Lisa	AUT
	MIRZAYEVA Farida	AZE

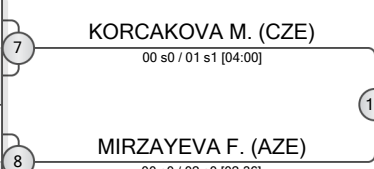

FINAL RESULTS		
1.	ALIYEVA Konul	AZE
2.	MIRZAYEVA Farida	AZE
3.	SUPERSON Anastasiia	UKR
3.	SIBILLE Victoria	BEL
5.	HENDRIKS Milou	NED
5.	KORCAKOVA Marketa	CZE
7.	RIKMANSPOEL Maud	NED
7.	WARNERS Megan	NED

REPECHAGE

RIKMANSPOEL M. (NED)	13	RIKMANSPOEL M. (NED) 01 s0 / 00 s2 [04:00]
YULDASHBEKOVA S. (KAZ)		
KUKHAR M. (UKR)		
HENDRIKS M. (NED)	14	HENDRIKS M. (NED) 00 s0 / 10 s1 [01:45]
WARNERS M. (NED)		
LOEHNER L. (GER)	15	WARNERS M. (NED) 00 s0 / 10 s1 [01:45]
PEHERSTORFER L. (AUT)		
KORCAKOVA M. (CZE)	16	KORCAKOVA M. (CZE) 00 s0 / 10 s1 [01:45]

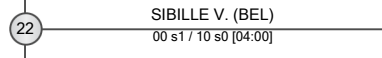
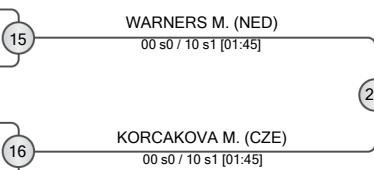
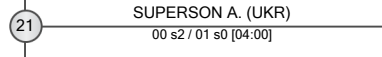
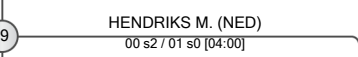
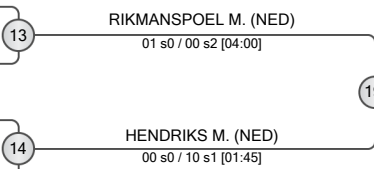



Poznan Junior European Cup 2024

Poland, Poznan, 13-14 Apr 2024

-52 kg
Women (22)

POOL A

	DJERIOU Lena	GER
	JAKOBCZYK Maria	POL
	MIROSHNICHENKO Marharyta	UKR
	GADASHOVA Khadizha	AZE
	KHUSNADIN Zarina	KAZ
	SEYNHAEVE Erin	BEL

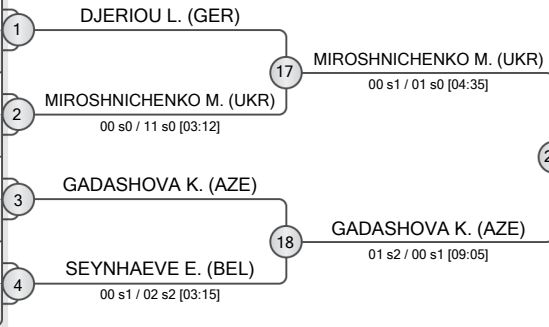

POOL B

	BOTHY Sarah	FRA
	GROSS Alexandra	GER
	WARNERS Glen	NED
	FROSZTEGA Iga	POL
	KAIRAT Ayaulym	KAZ

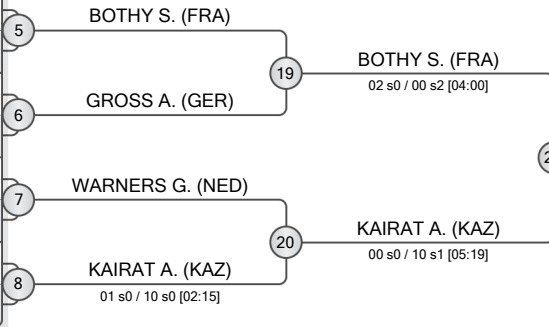

POOL C

	SARSENBEB Nurailym	KAZ
	MARQUES Alicia	FRA
	JETTER Lara Matilda	GER
	LIMZAIIEVA Tetiana	UKR
	SLAZOK Wiktoria	POL

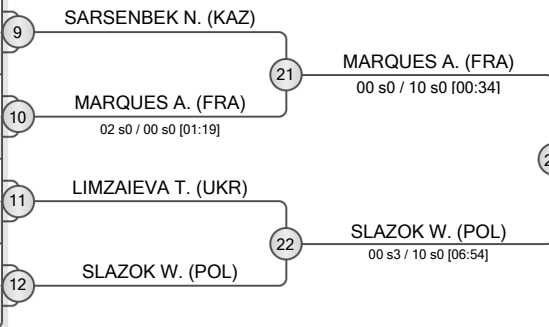

POOL D

	SICKINGER Larissa	AUT
	HRECHKA Sofia	UKR
	GULIYEVA Nuray	AZE
	ERIKSSON GHAZINOUR Isabella	SWE
	GUETH Nina	GER
	FACHE Lola	BEL

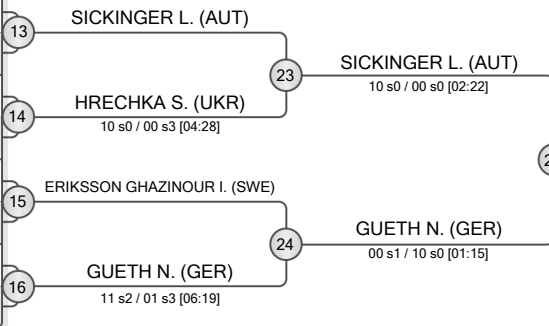

REPECHAGE

29 SEYNHAEVE E. (BEL)	30 GROSS A. (GER)	31 SARSENBEB N. (KAZ)	32 ERIKSSON GHAZINOUR I. (SWE)
33 MIROSHNICHENKO M. (UKR)	34 KAIRAT A. (KAZ)	35 SARSENBEB N. (KAZ)	36 FACHE L. (BEL)
37 BOTHY S. (FRA)	38 MARQUES A. (FRA)	39 KAIRAT A. (KAZ)	40 FACHE L. (BEL)
41 KAIRAT A. (KAZ)	42 FACHE L. (BEL)	43 BOTHY S. (FRA)	44 GADASHOVA K. (AZE)

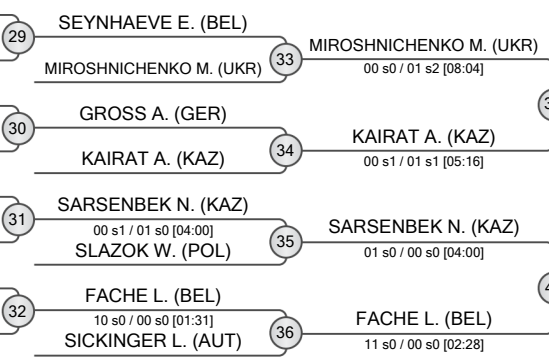

FINAL RESULTS	
1. BOTHY Sarah	FRA
2. MARQUES Alicia	FRA
3. KAIRAT Ayaulym	KAZ
3. FACHE Lola	BEL
5. GUETH Nina	GER
7. MIROSHNICHENKO Marharyta	UKR
7. SARSENBEB Nurailym	KAZ





Poznan Junior European Cup 2024

Poland, Poznan, 13-14 Apr 2024

-57 kg
Women (27)

POOL A

	ABDIROVA Dana	KAZ
	ZOZULINSKA Kalina	POL
	PATANE Maya	GER
	WATSON Nora	BEL
	CHERNUKHA Veronika	UKR
	HAYUN Ilay	ISR
	LIPPERT Sarah	AUT

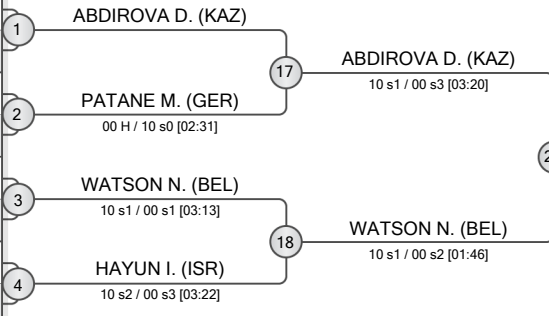

POOL B

	BIRRI Madeleine	GBR
	BAYRAMOVA Gulnara	AZE
	BIELAWSKA Emilia	POL
	BULANDA Julia	POL
	ZHALINOVA Akbota	KAZ
	AUMANN Felizitas	GER

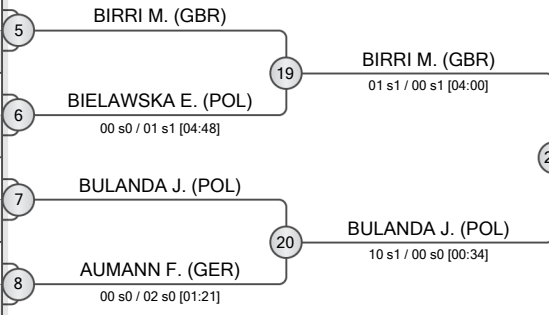

POOL C

	SHYNKARENKO Inna	UKR
	ROZENBAUM Magdalena	POL
	STERNON Camille	BEL
	DOIG Sunny	GBR
	NOUFAL Noor	NED
	RICHTER Miu	GER
	MUKHANBET Dina	KAZ

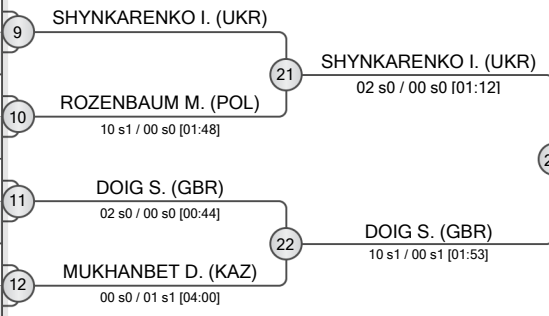

POOL D

	MELIS Emma	FRA
	KOSTER Skadi	GER
	SIENICKA Karolina	POL
	ZAGURI Daniella	ISR
	GASIMOVA Fidan	AZE
	ENDRIEKUTE Barbora	LTU
	WYBANSKA Aleksandra	POL

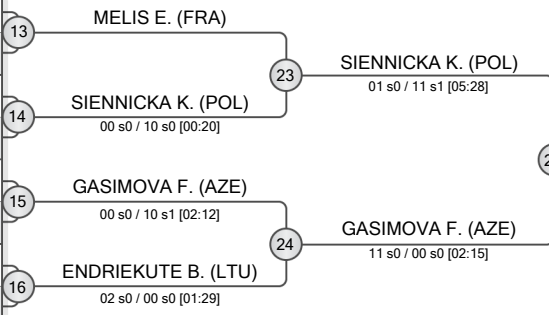

REPECHAGE

29: PATANE M. (GER)	30: AUMANN F. (GER)	31: ROZENBAUM M. (POL)	32: MELIS E. (FRA)
33: WATSON N. (BEL)	34: BIRRI M. (GBR)	35: DOIG S. (GBR)	36: GASIMOVA F. (AZE)

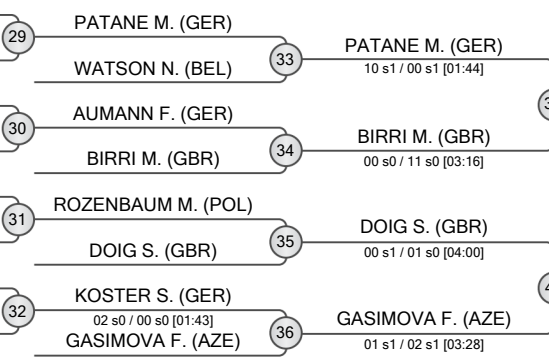

FINAL RESULTS	
1.	SIENICKA Karolina (POL)
2.	ABDIROVA Dana (KAZ)
3.	BIRRI Madeleine (GBR)
3.	BULANDA Julia (POL)
5.	SHYNKARENKO Inna (UKR)
7.	PATANE Maya (GER)
7.	GASIMOVA Fidan (AZE)





Poznan Junior European Cup 2024

Poland, Poznan, 13-14 Apr 2024

-63 kg
Women (29)

POOL A

	SKALSKA Anna	CZE
	PTASINSKA Amelia	POL
	MAYRHOFER Magdalena	AUT
	GRASSIN Eva	FRA
	NOWACZYK Alicja	POL
	BACKLUND Vilda	SWE
	VER EECKE Sara	BEL

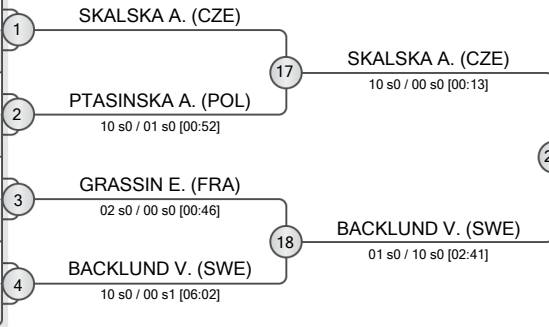

POOL B

	STARZER Emily	AUT
	RIDDERING Suus	NED
	TANZHARYKOVA Uldana	KAZ
	ATAYEVA Leyla	AZE
	WOODWARD Gabrielle	AUS
	SHMUEL Lior	ISR
	ECKMANN Greta	GER
	PIETRZAK Gabriela	POL

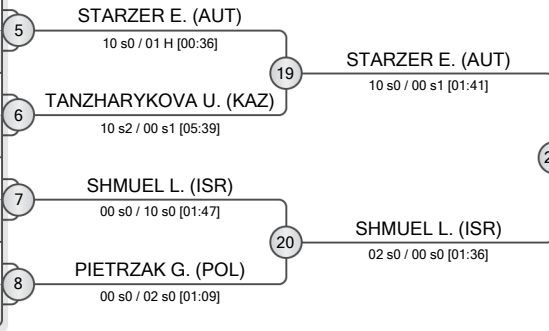

POOL C

	BAUER Sara-Joy	GER
	LEYSNER Mika	NED
	CHIPAN Jaelynn	FRA
	TELMAN Karlygash	KAZ
	DELAHUNTY Olivia	GBR
	NARVA Ada-Alexia	FIN
	STOJEK Nina	POL

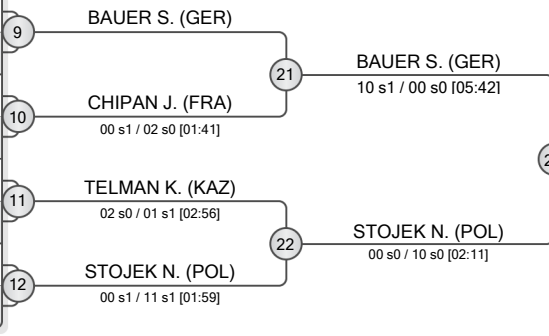

POOL D

	SCHLOEGL Franziska	AUT
	WITKOWSKA Wiktoria	POL
	TERLETSKA Olha	UKR
	TOMANKOVA Lenka	SVK
	SINNEMA Fleur	NED
	BAGNIEWSKA Amelia	POL
	LOVANG Tyra	SWE

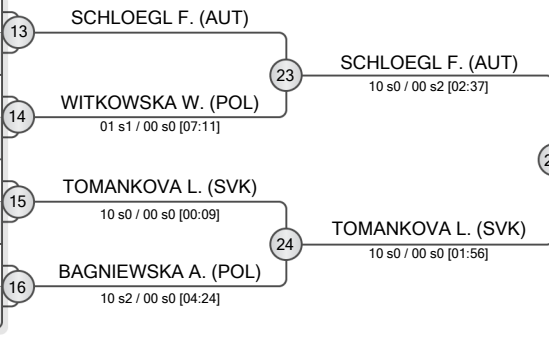

REPECHAGE

PTASINSKA A. (POL)	29	PTASINSKA A. (POL)	
WOODWARD G. (AUS)		BACKLUND V. (SWE)	33
PIETRZAK G. (POL)	30	PIETRZAK G. (POL)	
		STARZER E. (AUT)	34
		CHIPAN J. (FRA)	31
		STOJEK N. (POL)	35
WITKOWSKA W. (POL)	32	WITKOWSKA W. (POL)	
		TOMANKOVA L. (SVK)	36

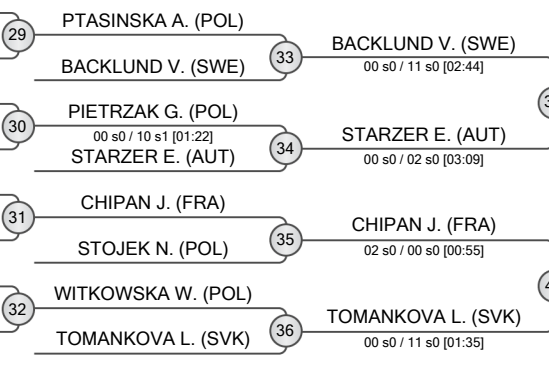

FINAL RESULTS	
1.	SHMUEL Lior
2.	SCHLOEGL Franziska
3.	BAUER Sara-Joy
3.	CHIPAN Jaelynn
5.	BACKLUND Vilda
7.	STARZER Emily
7.	TOMANKOVA Lenka





Poznan Junior European Cup 2024

Poland, Poznan, 13-14 Apr 2024

-70 kg
Women (25)

POOL A

	KOWALEWSKA Aleksandra	POL
	NILSSON Ingrid	SWE
	ABDULLAYEVA Parvana	AZE
	PAPP Maria	EST
	MARCZAK Julia	POL
	VIDENEIEVA Alisa	UKR
	NEMCOVA Barbora	CZE

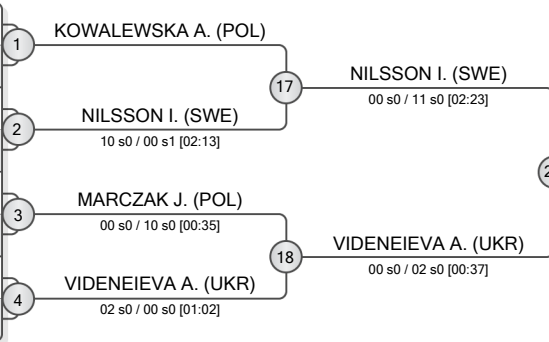

POOL B

	RYTSKA Mariia	UKR
	FIZELOVA Ema	SVK
	NUIJTEN Kaylie	NED
	HAYES Taylah	AUS
	ROMANIUK Marcelina	POL
	HAPPE Lilli	GER

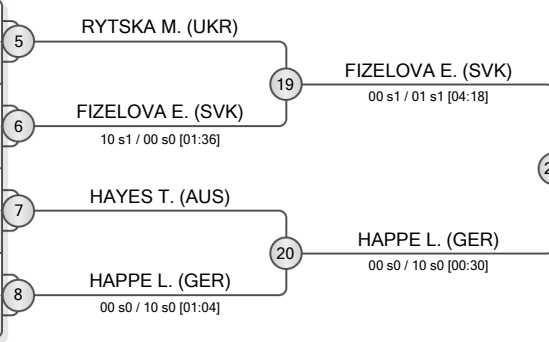

POOL C

	GRAUER Tayla	GER
	VANBRABANT Jutta	BEL
	NARVA Anni-Olivia	FIN
	WOOD Nicole	GBR
	BARON Wiktoria	POL
	ADIL Sagira	KAZ

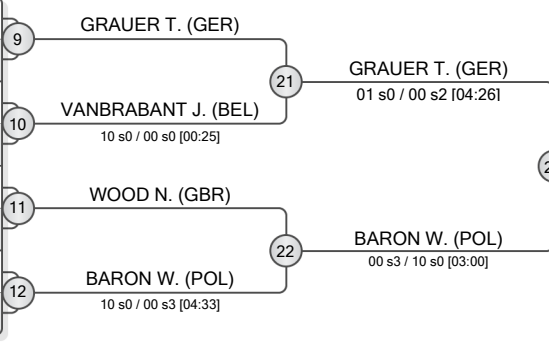

POOL D

	MALKA Avia	ISR
	NAVICKAITE Marta	LTU
	PIKOSZ Nicole	POL
	USANOVA Valeria	EST
	ROMER Lise May	FRA
	NEZNAIEVA Alona	UKR

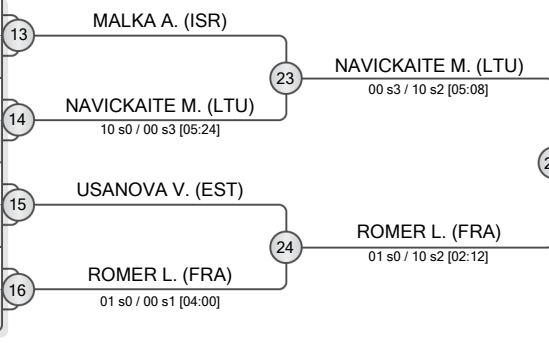

REPECHAGE

ABDULLAYEVA P. (AZE)	29	ABDULLAYEVA P. (AZE)	33	VIDENEIEVA A. (UKR)
KOWALEWSKA A. (POL)		10 s0 / 00 s0 [00:00]		00 s0 / 10 s0 [02:19]
NUIJTEN K. (NED)	30	NUIJTEN K. (NED)	34	HAPPE L. (GER)
RYTSKA M. (UKR)		02 s0 / 01 s1 [03:33]		00 s0 / 10 s0 [00:38]
VANBRABANT J. (BEL)	31	VANBRABANT J. (BEL)	35	BARON W. (POL)
NEZNAIEVA A. (UKR)		BARON W. (POL)		00 s3 / 10 s0 [03:21]
USANOVA V. (EST)	32	USANOVA V. (EST)	40	USANOVA V. (EST)
		00 s0 / 10 s0 [01:05]		00 s0 / 02 s0 [00:46]
		NAVICKAITE M. (LTU)	36	NILSSON I. (SWE)
		10 s0 / 00 s3 [02:34]		00 s1 / 10 s0 [02:31]

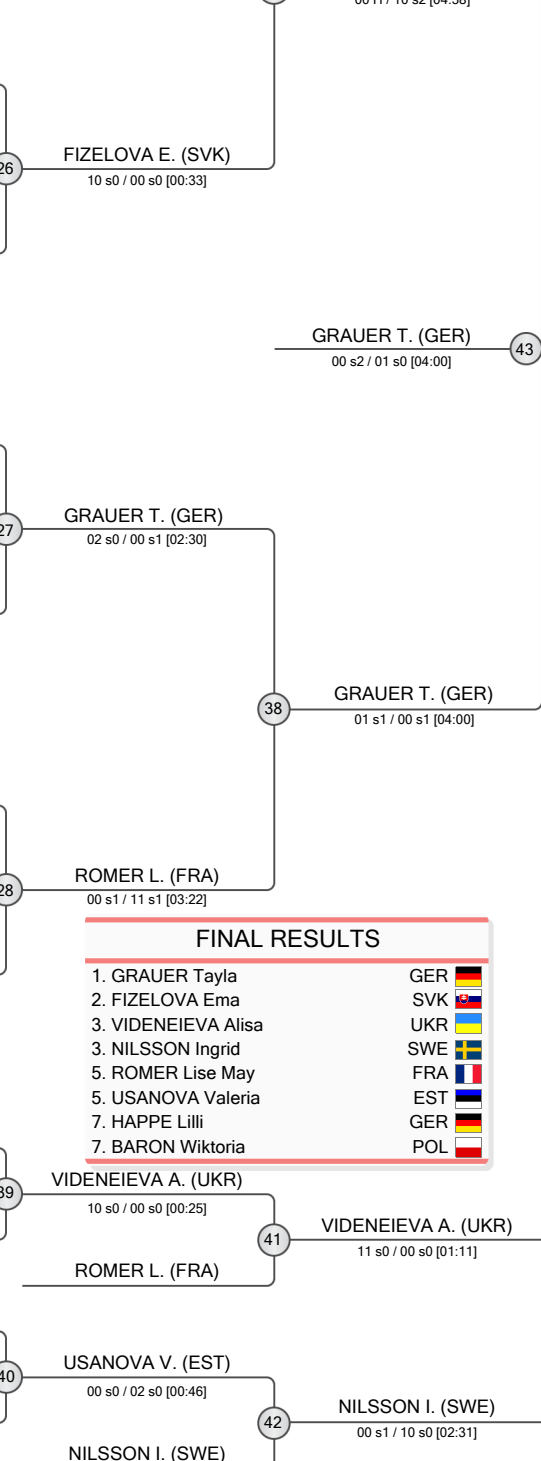

FINAL RESULTS	
1. GRAUER Tayla	GER
2. FIZELOVA Ema	SVK
3. VIDENEIEVA Alisa	UKR
3. NILSSON Ingrid	SWE
5. ROMER Lise May	FRA
7. HAPPE Lilli	GER
7. BARON Wiktoria	POL





Poznan Junior European Cup 2024

Poland, Poznan, 13-14 Apr 2024

-78 kg
Women (22)

POOL A

	NIEMEYER Mathilda Sophie	GER
	EININGE Saule	LTU
	OMAROVA Bakytgul	KAZ
	KUZMA-EBEL Dominika	POL
	SOKCEVIC Christina	AUT

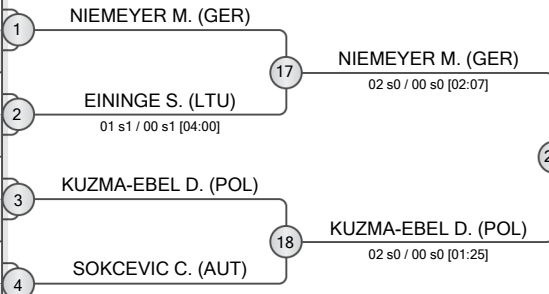

POOL B

	JOYCE Alannah	AUS
	TALVET Iti	EST
	LUEDEMANN Jessie	GER
	KAZAKOVA Anna	UKR
	HOJDAROVA Stepanka	CZE
	PETRIS Oceane	FRA

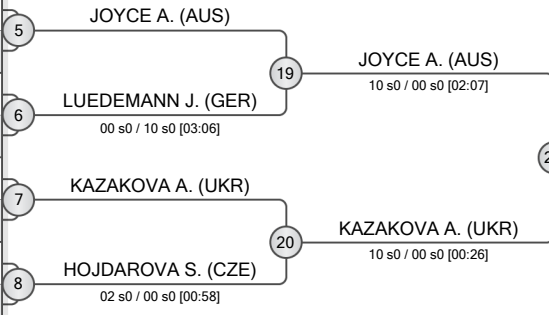

POOL C

	BUDDENKOTTE Eva Ronja	GER
	KOSNAROVA Marie	CZE
	ANSKEY Avalon	AUS
	KLEINLUGTENBELT Esther	NED
	DOLIA Daria	UKR
	WERNERT Jael	AUT

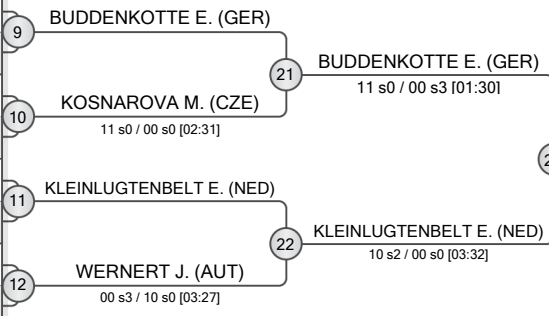

POOL D

	KRAPU Emma	FIN
	SCHREIBER Zyna	GER
	HANSTED E Linde	NED
	NAGACHEVSKAYA Anastassiya	KAZ
	BANASZEWSKA Zuzanna	POL

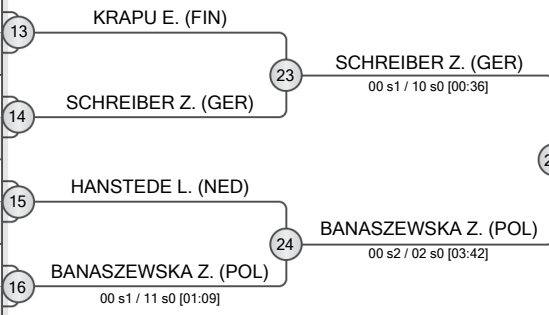

REPECHAGE

	EININGE S. (LTU)	29	EININGE S. (LTU)	33
	HOJDAROVA S. (CZE)	30	HOJDAROVA S. (CZE)	34
	KOSNAROVA M. (CZE)	31	KLEINLUGTENBELT E. (NED)	35
	NAGACHEVSKAYA A. (KAZ)		HANSTED E. L. (NED)	36
	HANSTED E. L. (NED)	32	SCHREIBER Z. (GER)	

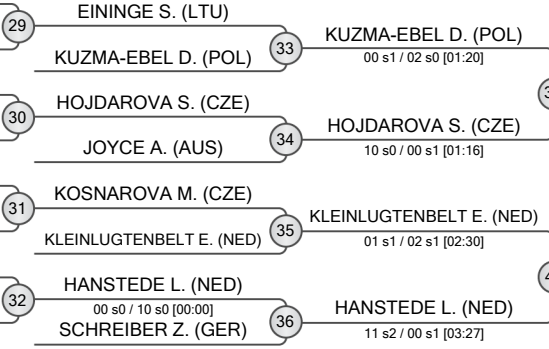

BUDDENKOTTE E. (GER) 43
00 s2 / 10 s1 [05:47]

FINAL RESULTS		
1.	BUDDENKOTTE Eva Ronja	GER
2.	NIEMEYER Mathilda Sophie	GER
3.	BANASZEWSKA Zuzanna	POL
3.	HANSTED E Linde	NED
5.	HOJDAROVA Stepanka	CZE
5.	KAZAKOVA Anna	UKR
7.	KUZMA-EBEL Dominika	POL
7.	KLEINLUGTENBELT Esther	NED



POOL A

BOUVIER Gabrielle BEL

BOUVIER G. (BEL)

POOL B

SEMCHENKO Diana UKR
 MAKHATOVA Ruslana KAZ

SEMCHENKO D. (UKR)

10 s1 / 00 s2 [05:45]

POOL C

STASIULYTE Rugile LTU

STASIULYTE R. (LTU)

POOL D

SULEYMANOVA Nigar AZE
 ZIEWALICZ Oliwia POL

ZIEWALICZ O. (POL)

00 s0 / 10 s0 [00:26]

REPECHAGE

MAKHATOVA R. (KAZ)

MAKHATOVA R. (KAZ)

SULEYMANOVA N. (AZE)

SULEYMANOVA N. (AZE)

SEMCHENKO D. (UKR)

BOUVIER G. (BEL)
10 s1 / 00 s3 [02:37]

STASIULYTE R. (LTU)
10 s0 / 00 s1 [02:44]

BOUVIER G. (BEL)
01 s2 / 00 s2 [04:37]

FINAL RESULTS

- | | | |
|----------------------|-----|--|
| 1. BOUVIER Gabrielle | BEL | |
| 2. STASIULYTE Rugile | LTU | |
| 3. MAKHATOVA Ruslana | KAZ | |
| 3. SEMCHENKO Diana | UKR | |
| 5. ZIEWALICZ Oliwia | POL | |
| 5. SULEYMANOVA Nigar | AZE | |

MAKHATOVA R. (KAZ)
02 s1 / 00 s0 [02:40]

SEMCHENKO D. (UKR)
02 s1 / 00 s0 [02:40]