



Teplice Cadet European Cup 2024

Czechia, Teplice, 6-7 Apr 2024

-50 kg
Men (26)

POOL A

	GALENKOV Ivo	BUL
	KITAGAWA Julius	GER
	PIPAN Tim	SLO
	BATALIN Nikita	UKR
	EGRT Jan	CZE
	NITSAN Boaz	ISR
	PENEZ Enzo	FRA

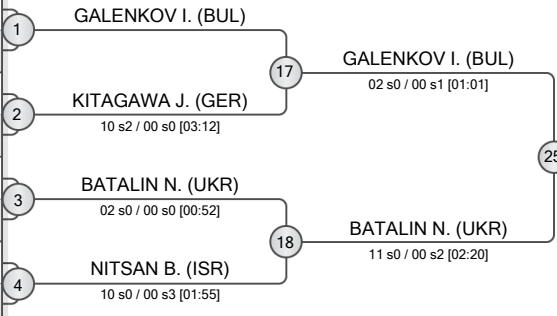

POOL B

	RADOVICS Mihály	HUN
	FRANZ Leonard	GER
	ATANASOV Atanas	BUL
	NEBENFUEHR Tim	GER
	MISKOVIC HASANBEGOVIC Noa	CRO
	JAKL Marek	CZE

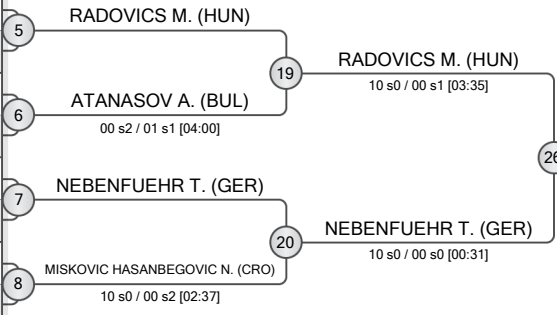

POOL C

	GUL Furkan Salih	TUR
	FOSER Nik	LIE
	CARP Maxim	MDA
	ELDAN Michael	ISR
	HRISTOV Emo	BUL
	SCHUMANN Janek Paul	GER
	JELINEK Karel	CZE

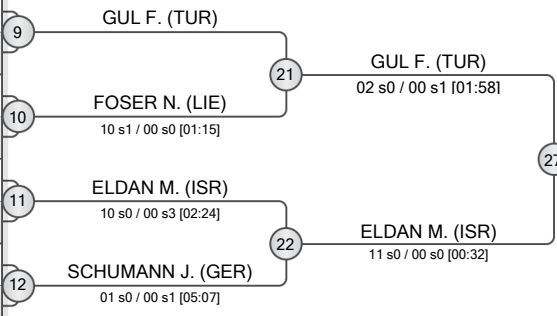

POOL D

	KOSTRYKIN Rostyslav	UKR
	GIVISHVILI Nikolozi	GEO
	PONEVACS Zoltan	HUN
	PINTO Francisco	POR
	SIMON Tege	ROU
	PUDOV Maxim	GER

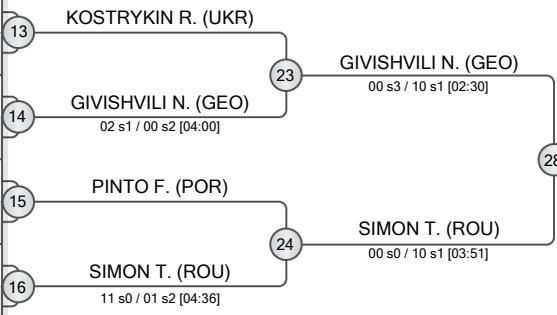

FINAL RESULTS	
1.	SIMON Tege
2.	BATALIN Nikita
3.	GALENKOV Ivo
3.	GIVISHVILI Nikolozi
5.	ELDAN Michael
5.	RADOVICS Mihály
7.	NEBENFUEHR Tim
7.	HRISTOV Emo

REPECHAGE

EGRT J. (CZE)	EGRT J. (CZE)	33
NITSAN B. (ISR)	GALENKOV I. (BUL)	33
ATANASOV A. (BUL)	NEBENFUEHR T. (GER)	34
HRISTOV E. (BUL)	HRISTOV E. (BUL)	35
SCHUMANN J. (GER)	GUL F. (TUR)	35
PUDOV M. (GER)	PUDOV M. (GER)	36
PINTO F. (POR)	GIVISHVILI N. (GEO)	36

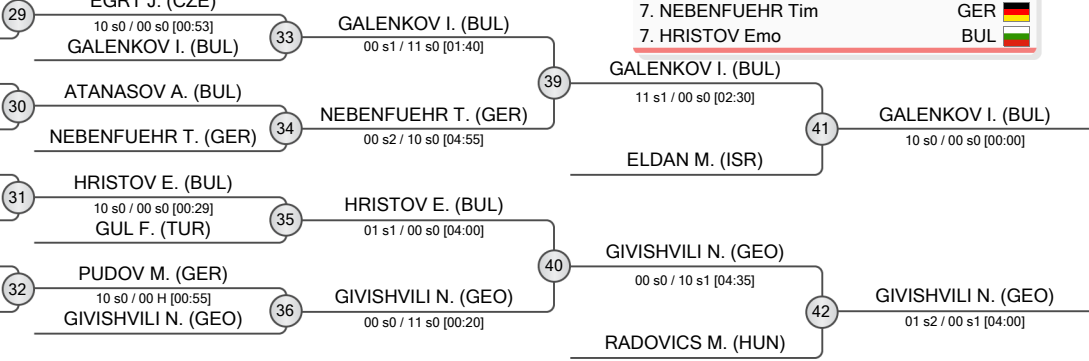



Teplice Cadet European Cup 2024

Czechia, Teplice, 6-7 Apr 2024

-55 kg

Men (60)

POOL A

1	AYZELMAN Yonatan (AUS)	1	AYZELMAN Y. (AUS)
2	TAZDAIT Jibril (FRA)	2	WINTER F. (GER)
3	WINTER Felix (GER)	3	GAVI I. (ISR)
4	GALIA Jan (CZE)	4	TROFYMOV I. (UKR)
5	GAVI Itay (ISR)	5	KALIASHVILI L. (GEO)
6	TOMIC Andrija (CRO)	6	KOJC K. (SLO)
7	TROFYMOV Ivan (UKR)	7	ARONGI Y. (ISR)
8	KALIASHVILI Luka (GEO)	8	BREZINA D. (CZE)
9	SHTAIN Tomer (ISR)	10	SPICKA M. (CZE)
10	MUNTSUROV Mohamed (AUT)	11	SPICKA M. (CZE)
11	KOJC Kenzo (SLO)	12	SPICKA M. (CZE)
12	ARONGI Yehonatan (ISR)	13	SPICKA M. (CZE)
13	ADYLBKOV Alymbek (KGZ)	14	SPICKA M. (CZE)
14	SCHRODL Kornel (HUN)	15	SPICKA M. (CZE)
15	BREZINA David (CZE)	16	SPICKA M. (CZE)

POOL B

9	FIGUEIREDO Manuel (POR)	9	FIGUEIREDO M. (POR)
10	PENNINGA Silas (DEN)	10	LACIKA S. (SVK)
11	LACIKA Silvio (SVK)	11	GRUBER M. (AUT)
12	GRUBER Matteo (AUT)	12	CHUHNENKO R. (ISR)
13	RAIDOS Aristotelis (GER)	13	CHUHNENKO R. (ISR)
14	ZINCHUK Maksym (UKR)	14	CHUHNENKO R. (ISR)
15	CHUHNENKO Roma (ISR)	15	CHUHNENKO R. (ISR)
16	POGREB Max (AUS)	16	POGREB M. (AUS)
17	BOENISCH Oliver (GER)	17	BOENISCH O. (GER)
18	SORICI Alin Marian (ROU)	18	HEYDAROV K. (UKR)
19	HEYDAROV Khazar (UKR)	19	HEYDAROV K. (UKR)
20	BARNATAN Ori (ISR)	20	BARNATAN O. (ISR)
21	BERTHOLOM Elliott (FRA)	21	BARNATAN O. (ISR)
22	STEFANEK Hunor (HUN)	22	BARNATAN O. (ISR)
23	SPICKA Matej (CZE)	23	BARNATAN O. (ISR)

POOL C

17	KUNYIK Botond (HUN)	17	KUNYIK B. (HUN)
18	MATVIICHUK Vladyslav (UKR)	18	MATVIICHUK V. (UKR)
19	NEVO Yftach (ISR)	19	NEVO Y. (ISR)
20	GRUBER Maximilian Koh (GER)	20	PEETERS M. (BEL)
21	PEETERS Milan (BEL)	21	BACHOSHVILI S. (GEO)
22	BACHOSHVILI Shota (GEO)	22	BACHOSHVILI S. (GEO)
23	BUTUCI Kristian (CRO)	23	BACHOSHVILI S. (GEO)
24	MUNIZ ACOSTA Jakub (POL)	24	MUNIZ ACOSTA J. (POL)
25	VASILEV Viktor (BUL)	25	MUNIZ ACOSTA J. (POL)
26	SIMKHAEV Tom (ISR)	26	SIMKHAEV T. (ISR)
27	PFANDL Jan (AUT)	27	SIMKHAEV T. (ISR)
28	BERGER Arthur (GER)	28	BERGER A. (GER)
29	ANGHEL Mario (ROU)	29	BERGER A. (GER)
30	TZUR Idan (ISR)	30	TZUR I. (ISR)
31	PANCNER Marek (CZE)	31	TZUR I. (ISR)

POOL D

25	GLASER Julius (GER)	25	GLASER J. (GER)
26	CHEN Ilay (ISR)	26	CHEN I. (ISR)
27	VALJENT Matyas (CZE)	27	SHAASHOUA C. (ISR)
28	PUHACHOV Nazar (UKR)	28	SHAASHOUA C. (ISR)
29	SHAASHOUA Chanoch Eliezer (ISR)	29	SHAASHOUA C. (ISR)
30	VASVARI Ianis Raul (ROU)	30	VASVARI I. (ROU)
31	MOUNIER Quentin (FRA)	31	VASVARI I. (ROU)
32	BUSURASHVILI Goga (GEO)	32	BUSURASHVILI G. (GEO)
33	ASMAN Noah (AUS)	33	TURILOV O. (UKR)
34	TURILOV Oleksandr (UKR)	34	TURILOV O. (UKR)
35	REIMANN PAULUS Natan (GER)	35	TURILOV O. (UKR)
36	MILJIC Srdjan (SRB)	36	MILJIC S. (SRB)
37	BILGE Enes (TUR)	37	MILJIC S. (SRB)
38	TZEMAH Yali (ISR)	38	TZEMAH Y. (ISR)
39	ORNIK Yann (AUT)	39	TZEMAH Y. (ISR)

REPECHAGE

61	SHTAIN T. (ISR)	61	SHTAIN T. (ISR)
62	KOJC K. (SLO)	62	ARONGI Y. (ISR)
63	SORICI A. (ROU)	63	ARONGI Y. (ISR)
64	POGREB M. (AUS)	64	ARONGI Y. (ISR)
65	BUTUCI K. (CRO)	65	ARONGI Y. (ISR)
66	PEETERS M. (BEL)	66	ARONGI Y. (ISR)
67	ORNIK Y. (AUT)	67	ARONGI Y. (ISR)
68	MILJIC S. (SRB)	68	ARONGI Y. (ISR)

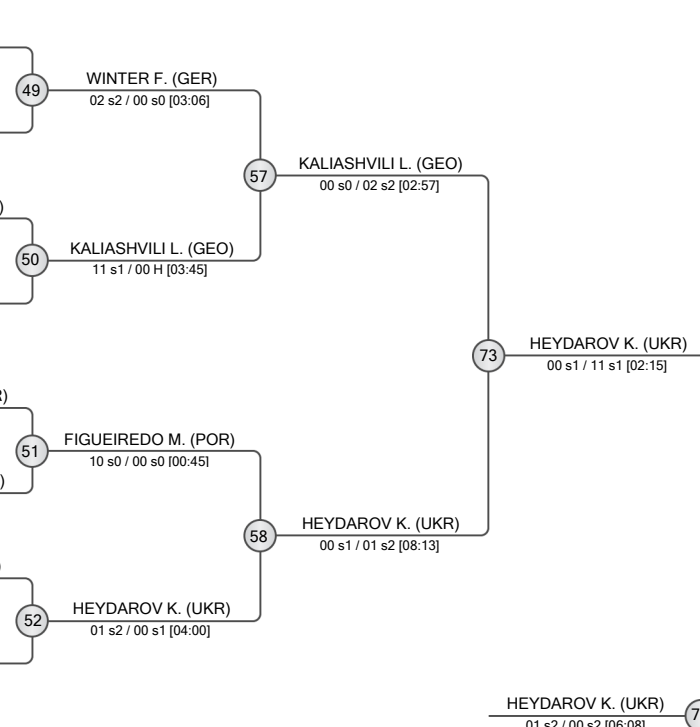

FINAL RESULTS		
1.	HEYDAROV Khazar	UKR
2.	BACHOSHVILI Shota	GEO
3.	FIGUEIREDO Manuel	POR
3.	KALIASHVILI Luka	GEO
5.	TZEMAH Yali	ISR
5.	KUNYIK Botond	HUN
7.	WINTER Felix	GER
7.	TURILOV Oleksandr	UKR





Teplice Cadet European Cup 2024

Czechia, Teplice, 6-7 Apr 2024

-60 kg

Men (61)

POOL A

VARNICIC Veljko (SRB)	1	VARNICIC V. (SRB)	33	VARNICIC V. (SRB)
NEMASIK Matej (SVK)	2	ZIROLIA G. (ITA)	00 s2 / 10 s0 [02:56]	02 s1 / 00 s0 [01:39]
ZIROLIA Giuseppe (ITA)	3	STOEGMANN S. (AUT)	00 s1 / 10 s0 [06:08]	49
FEKE Adam (HUN)	4	EL RHABA Z. (FRA)	01 s2 / 10 s0 [03:35]	EL RHABA Z. (FRA)
STOEGMANN Stefan (AUT)	5	SHARIPASHVILI Sandro (GEO)	10 s0 / 00 s0 [00:17]	57
NAGIMULIN Alihan (GER)	6	XU A. (AUS)	02 s0 / 00 s0 [01:33]	SHARIPASHVILI S. (GEO)
EL RHABA Ziyad (FRA)	7	KNEZ F. (CRO)	00 s0 / 10 s0 [00:46]	50
SHARIPASHVILI Sandro (GEO)	8	RAIDOS A. (GER)	10 s0 / 00 s0 [01:18]	SHARIPASHVILI S. (GEO)
DVORAK Petr (CZE)				
XU Aaron (AUS)				
PIPAN Nik (SLO)				
KOZIUK Dmytro (UKR)				
KNEZ Filip (CRO)				
RAIDOS Apollon (GER)				
OVERCHENKO Maksim (ISR)				

POOL B

RAZDEVSEK Matic (SLO)	9	RAZDEVSEK M. (SLO)	37	KIS L. (HUN)
BASOV Renat (UKR)	10	KIS L. (HUN)	00 s0 / 02 s0 [01:34]	51
TOMSU Jakub (CZE)	11	HEINEMANN F. (GER)	01 s0 / 00 s0 [04:00]	WISNIEWSKI D. (POL)
KIS Levente (HUN)	12	WISNIEWSKI D. (POL)	10 s0 / 00 s0 [00:16]	58
HEINEMANN Finn (GER)	13	GALO B. (HUN)	10 s0 / 00 s0 [00:15]	GALO B. (HUN)
CORMACK Angus (AUS)	14	VOGEL S. (GER)	00 s1 / 10 s0 [02:07]	52
WISNIEWSKI Dawid (POL)	15	AHARON A. (ISR)	01 s0 / 10 s1 [03:13]	MARTIN K. (FRA)
POBLOCKI Samir (SWE)	16	MARTIN K. (FRA)	00 s1 / 02 s1 [02:25]	40
GALO Bence (HUN)				
BEZPALEC Jonas (CZE)				
ANGHEL Artemie (MDA)				
VOGEL Sebastian (GER)				
BEZIC Ivan (CRO)				
AHARON Ariel (ISR)				
KHARLAMOV Yaroslav (UKR)				
MARTIN Kylian (FRA)				

POOL C

KEKVIASHVILI Gigi (GEO)	17	KEKVIASHVILI G. (GEO)	41	CAETANO D. (POR)
CAETANO Diogo (POR)	18	CAETANO D. (POR)	10 s0 / 00 s1 [01:53]	53
TOMAS Michal (SVK)	19	KUPPER D. (GER)	10 s1 / 00 H [03:29]	42
KUPPER David (GER)	20	OLIINYK I. (UKR)	00 s1 / 10 s0 [03:23]	59
MOLNAR Zsombor (HUN)	21	LEE C. (AUS)	11 s0 / 00 s0 [03:37]	FEDORA F. (HUN)
TOMASIC Mateo (CRO)	22	FEDORA F. (HUN)	10 s0 / 00 s1 [03:04]	54
OLIINYK Illia (UKR)	23	FAAS S. (NED)	11 s1 / 00 s0 [02:21]	44
LEE Casey (AUS)	24	ZHARINOV I. (UKR)	02 s0 / 01 s0 [01:12]	55
TCACI Stanislav (CZE)				
FEDORA Ferenc (HUN)				
TODI Leonard (GER)				
FAAS Siebe (NED)				
GEVRYIE Gabriel (SWE)				
ZHARINOV Illia (UKR)				
LIVNI Ollie (ISR)				

POOL D

SAMEC Jaka (SLO)	25	SAMEC J. (SLO)	45	SAMEC J. (SLO)
RAABE Benjamin (GER)	26	RAABE B. (GER)	11 s2 / 00 s3 [03:52]	55
DOLEZAL Jan (CZE)	27	IONITA D. (ROU)	10 s0 / 00 H [00:34]	46
IONITA David (ROU)	28	GAL K. (HUN)	10 s0 / 01 s0 [01:18]	60
GATEAU Elliott (FRA)	29	DATASHVILI L. (GEO)	11 s0 / 00 s0 [01:03]	47
GAL Kristof (HUN)	30	BUETTNER W. (GER)	02 s0 / 00 s0 [00:48]	56
TODOROVIC Ivan (CRO)	31	MAKALATIYA D. (GER)	00 s0 / 02 s0 [01:38]	48
DATASHVILI Luka (GEO)	32	NIELSEN E. (DEN)	00 s0 / 02 s0 [03:32]	56
CHLADEK David (CZE)				
BUETTNER Willy (GER)				
LIAKHOVYI Mykhailo (UKR)				
GABRIEL Igor (POL)				
MAKALATIYA Demetre (GER)				
HAZENSHPRUNG Itay (ISR)				
NIELSEN Emil (DEN)				

REPECHAGE

DVORAK P. (CZE)	61	DVORAK P. (CZE)	65	KNEZ F. (CRO)
XU A. (AUS)		KNEZ F. (CRO)	01 s1 / 02 s1 [02:46]	69
TOMSU J. (CZE)		EL RHABA Z. (FRA)	10 s0 / 00 s0 [00:00]	75
RAZDEVSEK M. (SLO)	62	RAZDEVSEK M. (SLO)	02 s0 / 00 s1 [02:04]	70
WISNIEWSKI D. (POL)		GALO B. (HUN)	00 s0 / 01 s2 [04:00]	77
TODI L. (GER)				
LEE C. (AUS)	63	LEE C. (AUS)	01 s0 / 02 s2 [05:12]	71
ZHARINOV I. (UKR)		CAETANO D. (POR)	10 s0 / 00 s0 [00:31]	76
GABRIEL I. (POL)				
NIELSEN E. (DEN)	64	NIELSEN E. (DEN)	00 s0 / 11 s0 [01:02]	72
DATASHVILI L. (GEO)		DATASHVILI L. (GEO)	11 s0 / 00 s1 [01:59]	78
		SAMEC J. (SLO)		

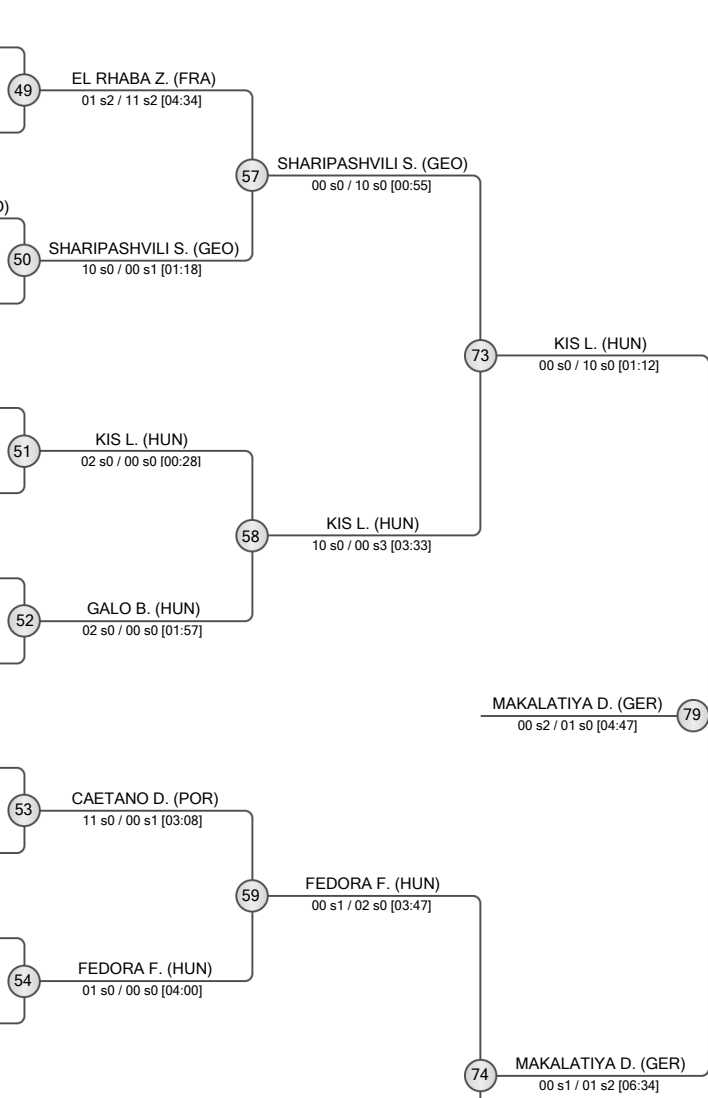

FINAL RESULTS	
1. MAKALATIYA Demetre	GER
2. KIS Levente	HUN
3. KNEZ Filip	CRO
3. DATASHVILI Luka	GEO
5. FEDORA Ferenc	HUN
5. SHARIPASHVILI Sandro	GEO
7. GALO Bence	HUN
7. ZHARINOV Illia	UKR





Teplice Cadet European Cup 2024

Czechia, Teplice, 6-7 Apr 2024

-66 kg
Men (65)

POOL A

1	GIVISHVILI Giorgi (GEO)
2	BENZAKEN Emri (ISR)
3	MAKHASHEV Elbert (AUT)
4	KLIMSA Jan (CZE)
5	GONDOR Kristof (HUN)
6	SANDLERMAN Artur (POL)
7	GAFFARLI AI-Huseyn (GER)
8	NOVAKOVIC Milan (BIH)
9	JANKOVIC Boris (SRB)
10	PEHRSON Leo (SWE)
11	WEGELE Maxim (GER)
12	RADUCANU Ionut (ROU)
13	BABACHEV Stiliyan (BUL)
14	SIMSEK Mustafa Berat (TUR)
15	RESUTIK Adam (CZE)
16	OSTAPENKO Bohdan (UKR)

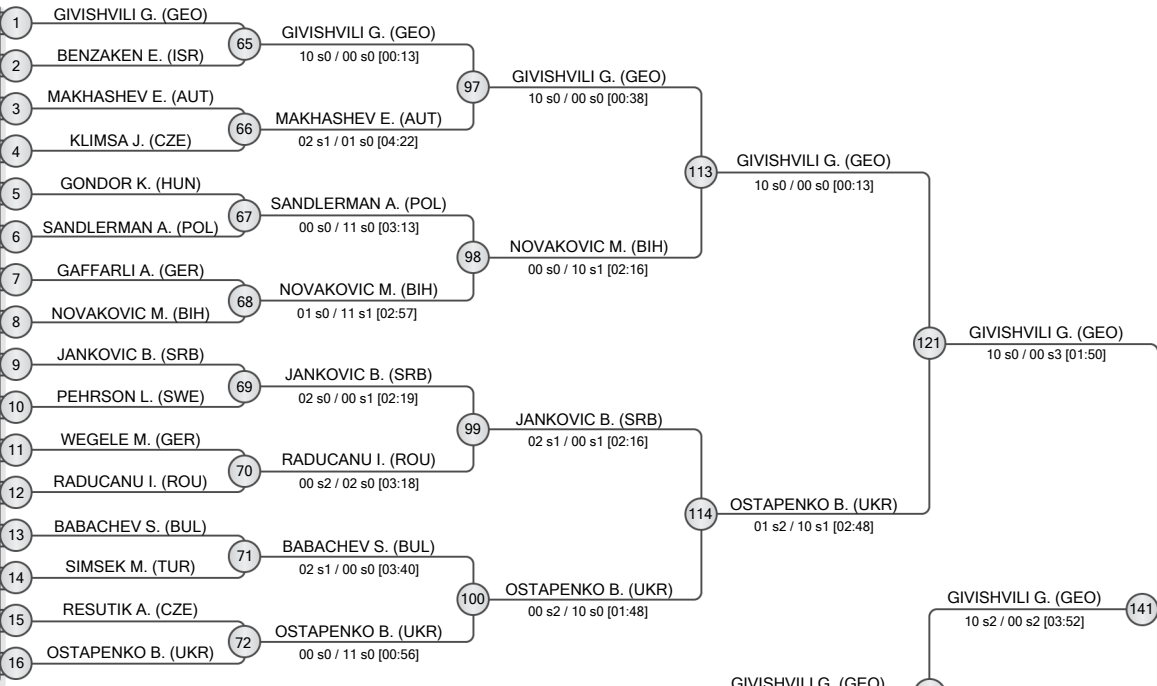

POOL B

17	NAZARENKO Illia (UKR)
18	PAUSKIC Silas (DEN)
19	CEREDNICENKO Artur (CZE)
20	GIGILASHVILI Luka (GBR)
21	LEVI Achiad (ISR)
22	HEILMANN Maalik (GER)
23	NIKOLOV Milen (BUL)
24	LEB Stefan (AUT)
25	GAMEZARDASHVILI Vasil (GEO)
26	RUPPRICH Albert (GER)
27	RAFFAY Levente (HUN)
28	MEKINC Klemen (SLO)
29	CONDREA Ion (MDA)
30	GRUBER Julius (GER)
31	VOSTREL Vit (CZE)
32	ARSLAN Hozan (AUT)

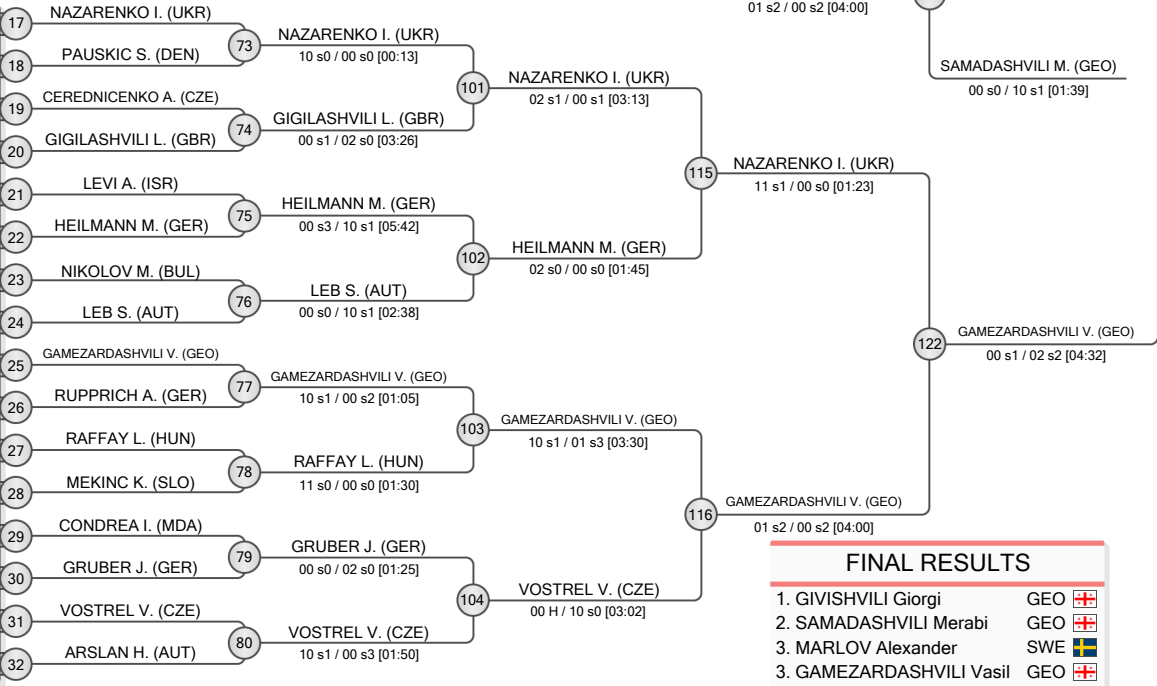

FINAL RESULTS		
1.	GIVISHVILI Giorgi	GEO
2.	SAMADASHVILI Merabi	GEO
3.	MARLOV Alexander	SWE
3.	GAMEZARDASHVILI Vasil	GEO
5.	OSTAPENKO Bohdan	UKR
5.	BARSKÉ Rufus	GER
7.	NAZARENKO Illia	UKR
7.	HADZI-VELJKOVIC Nikola	CRO

REPECHAGE

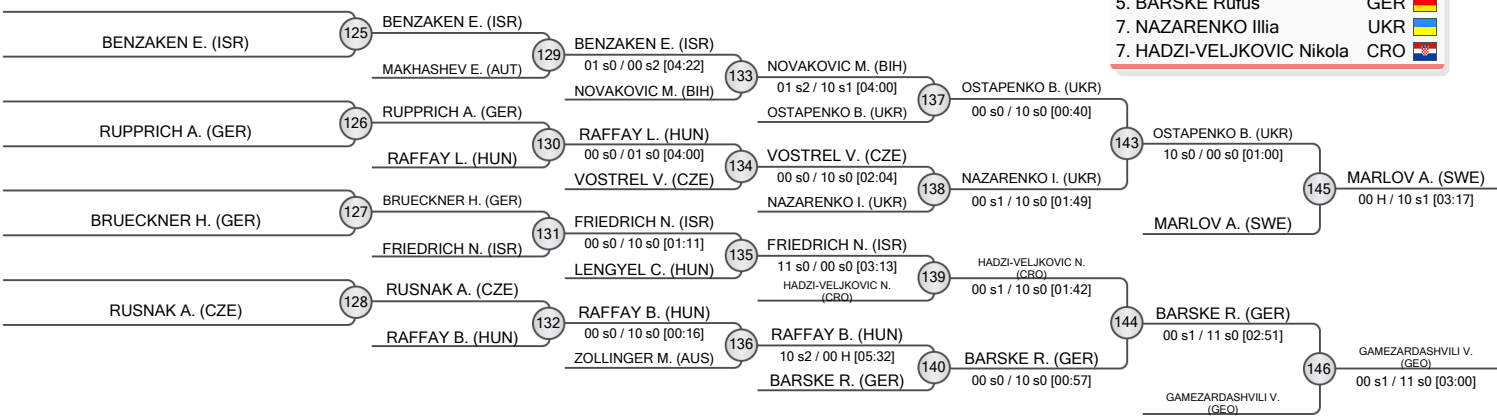



Teplice Cadet European Cup 2024

Czechia, Teplice, 6-7 Apr 2024

-66 kg
Men (65)

POOL C

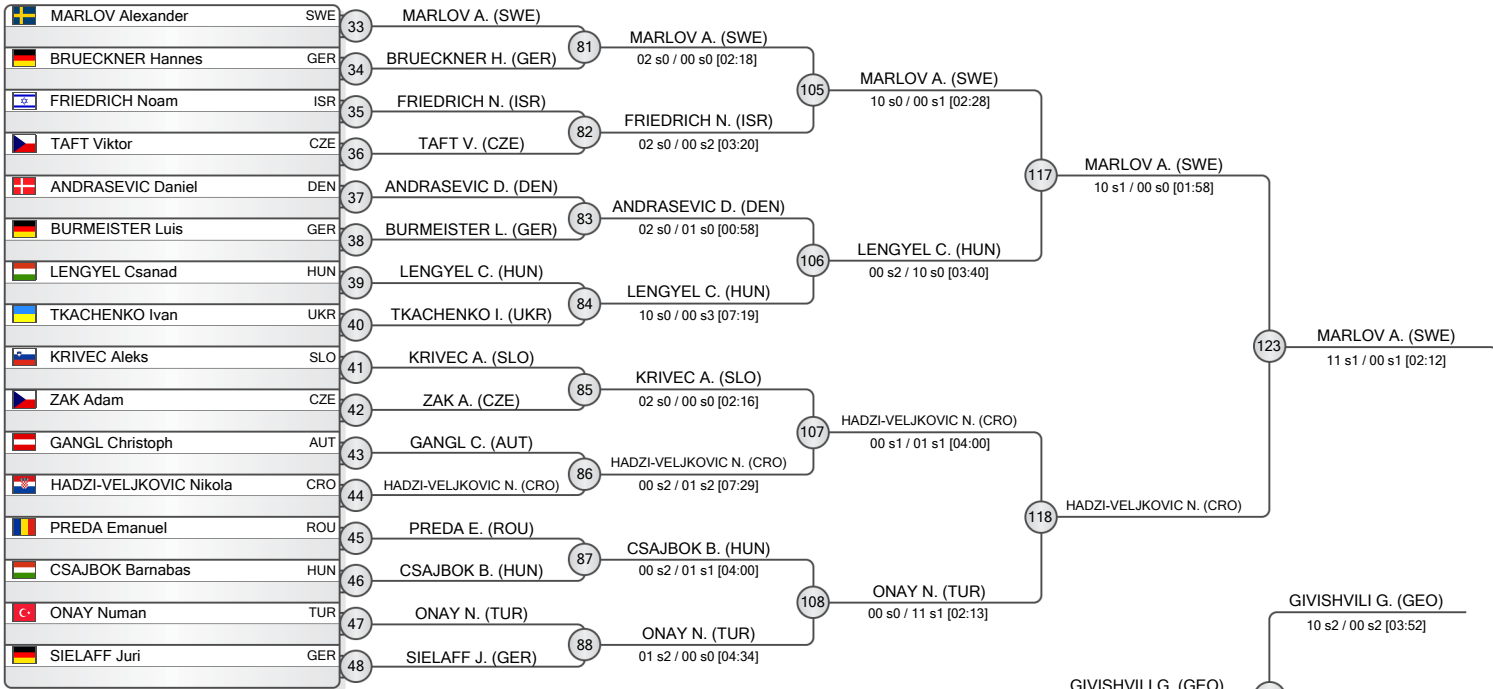

POOL D

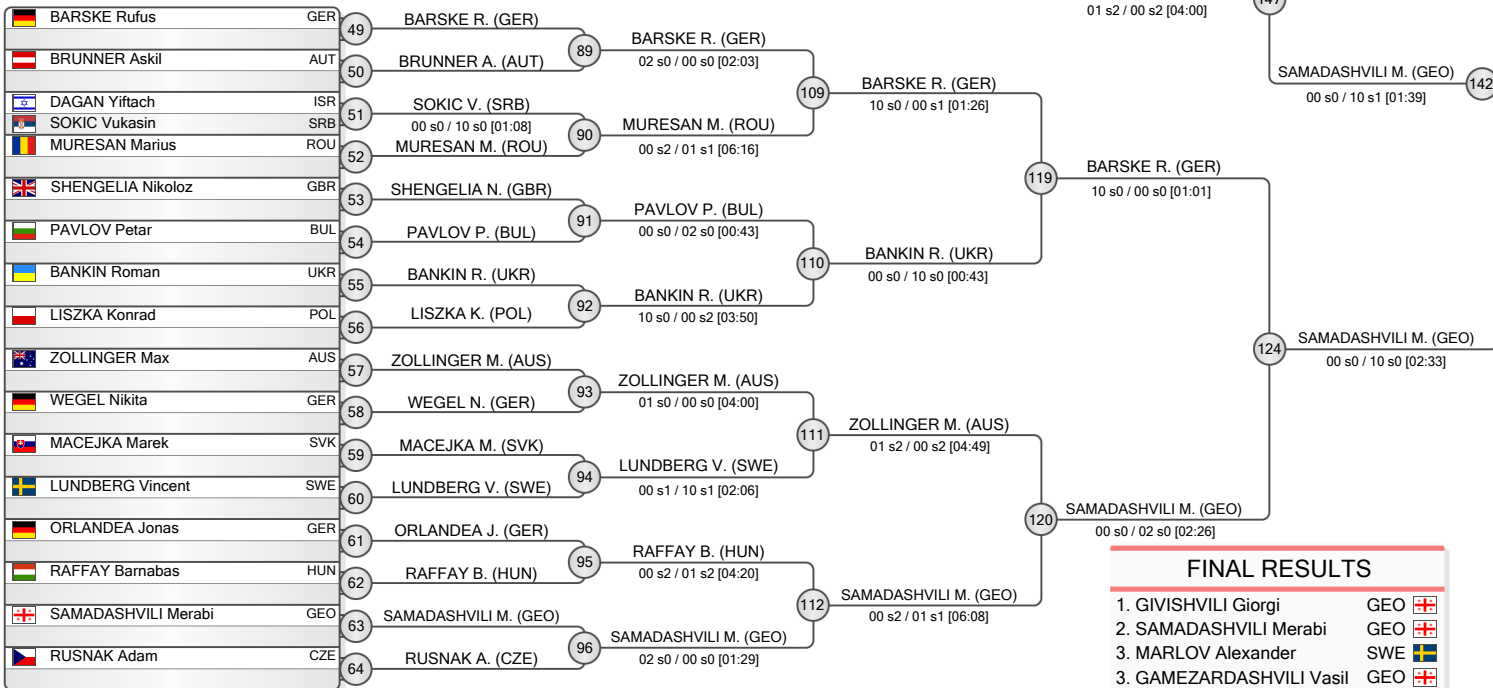

FINAL RESULTS		
1.	GIVISHVILI Giorgi	GEO 🇬🇪
2.	SAMADASHVILI Merabi	GEO 🇬🇪
3.	MARLOV Alexander	SWE 🇸🇪
3.	GAMEZARDASHVILI Vasil	GEO 🇬🇪
5.	OSTAPENKO Bohdan	UKR 🇺🇦
5.	BARSKE Rufus	GER 🇩🇪
7.	NAZARENKO Illia	UKR 🇺🇦
7.	HADZI-VELJKOVIC Nikola	CRO 🇭🇷

REPECHAGE

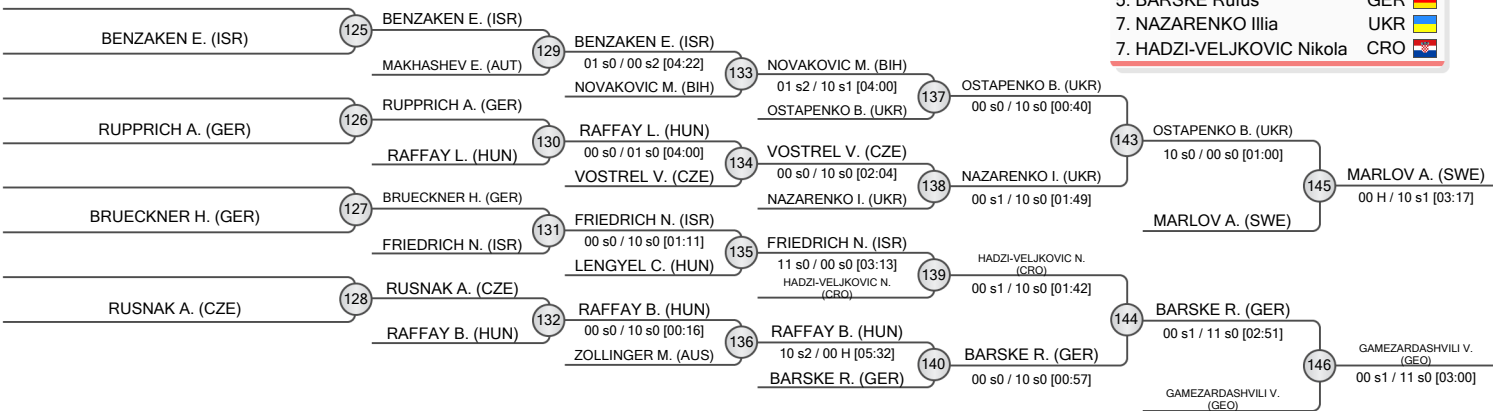



Teplice Cadet European Cup 2024

Czechia, Teplice, 6-7 Apr 2024

-73 kg

Men (63)

POOL A

1	VELICKOVIC Bogdan (SRB)	1	VELICKOVIC B. (SRB)
2	GIJS Fidder (NED)	2	DUBINIENKO Y. (UKR)
3	PERETS Itai (ISR)	3	EINFINGER F. (AUT)
4	EINFINGER Felix (AUT)	4	DISTEL R. (GER)
5	DISTEL Roman (GER)	5	ZIPORA Y. (ISR)
6	BADEA Teodor (ROU)	6	MUSZYNSKI J. (POL)
7	DOBRIĆ Nikola (AUS)	7	HORVATH N. (HUN)
8	ZIPORA Yair (ISR)	8	VOLZ M. (GER)
	GÖNSCHÖREK Philipp (GER)		
	MUSZYNSKI Jakub (POL)		
	HORVATH Nandor (HUN)		
	LUXEMBURK Daniel (CZE)		
	BONDARENKO Daniel (UKR)		
	VOLZ Mark (GER)		

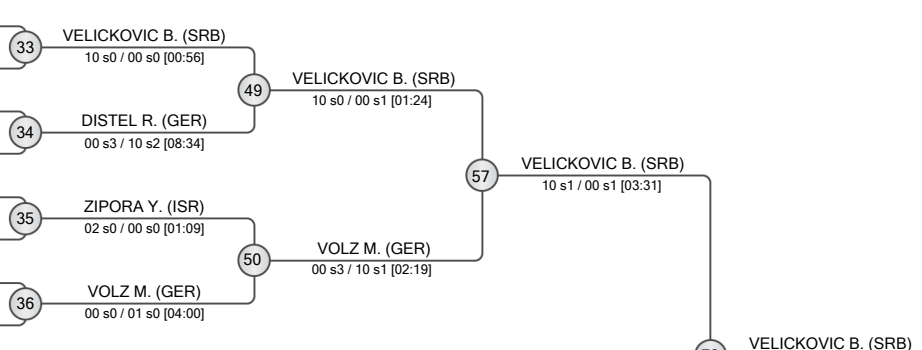

POOL B

9	MAROUSEK Alex (CZE)	9	MAROUSEK A. (CZE)
10	MARTINI Nicolas (GER)	10	STOPP P. (HUN)
11	GERSTGRASER Valentin (AUT)	11	GORUN V. (UKR)
12	STOPP Patrik (HUN)	12	MILANOVIC V. (SRB)
13	FUNKE Thies (GER)	13	ROEDER H. (GER)
14	GORUN Volodymyr (UKR)	14	FICTUM M. (CZE)
15	MILANOVIC Veljko (SRB)	15	MERCEA D. (ROU)
16	CORLUKA Roko (CRO)	16	DVALI G. (GEO)
	ROEDER Henry (GER)		
	SAKHAROV Nikita (UKR)		
	BEN LAICHE Edo (ISR)		
	FICTUM Martin (CZE)		
	MERCEA David Emanuel (ROU)		
	NAIDIUK Volodymyr (UKR)		
	DVALI Giorgi (GEO)		
	SINJER Nichita (MDA)		

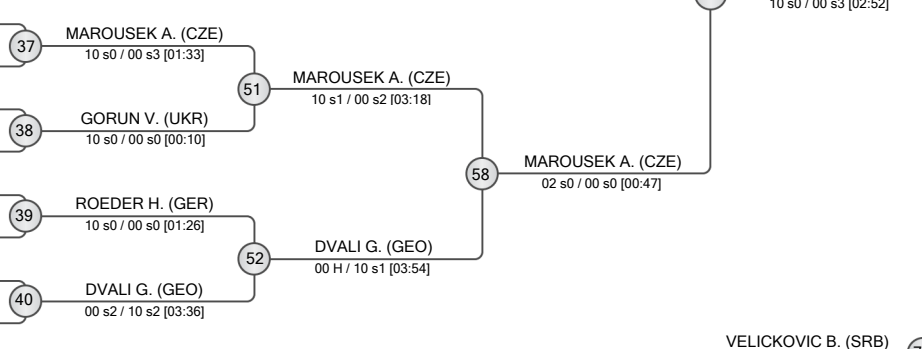

POOL C

17	DULARIDZE Lado (GEO)	17	DULARIDZE L. (GEO)
18	NOACK Melvin (GER)	18	PIDKIPNYY G. (UKR)
19	HERSHCOVITZ Niv (ISR)	19	PESTEREW P. (GER)
20	PIDKIPNYY Glib (UKR)	20	BYELGORODSKYI K. (UKR)
21	REBELO OSORIO Marcos (LUX)	21	GAU K. (GER)
22	PESTEREW Phillip (GER)	22	BETKOWSKI J. (POL)
23	BYELGORODSKYI Kostiantyn (UKR)	23	BALENKO Y. (UKR)
24	MAN Darius (ROU)	24	POSPISIL M. (CZE)
	GAU Kirill (GER)		
	SIMUNIC Fran (CRO)		
	MILJIC Sinisa (SRB)		
	BETKOWSKI Jeremiasz (POL)		
	BALENKO Yehor (UKR)		
	PIMA Ilay (ISR)		
	GRABNER Erik (AUT)		
	POSPISIL Matej (CZE)		

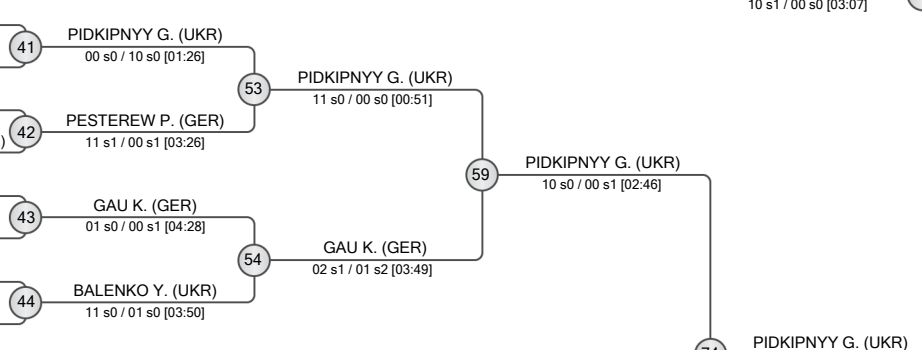

POOL D

25	MUMLADZE Giorgi (GEO)	25	MUMLADZE G. (GEO)
26	KISS Szabolcs (HUN)	26	KOBYLINSKI J. (POL)
27	KOBYLINSKI Jakub (POL)	27	SEDLAK M. (CZE)
28	YOKOYAMA Yuichi (GER)	28	LALEIKE Y. (GER)
29	BABICH Vladyslav (UKR)	29	RUDENKO T. (UKR)
30	SEDLAK Martin (CZE)	30	MARGREITER S. (AUT)
31	BAINVOLL Tomer (ISR)	31	VLACH M. (CZE)
32	LALEIKE Yoshiya (GER)	32	NIFTULLAIEV A. (UKR)
	RUDENKO Tymofii (UKR)		
	PFOTENHAUER Thorben (GER)		
	HAVRANEK Josip (CRO)		
	MARGREITER Simon (AUT)		
	VLACH Marek (CZE)		
	NAPSO Aslan (ISR)		
	NIFTULLAIEV Anar (UKR)		
	MEIER Gabriel (LIE)		

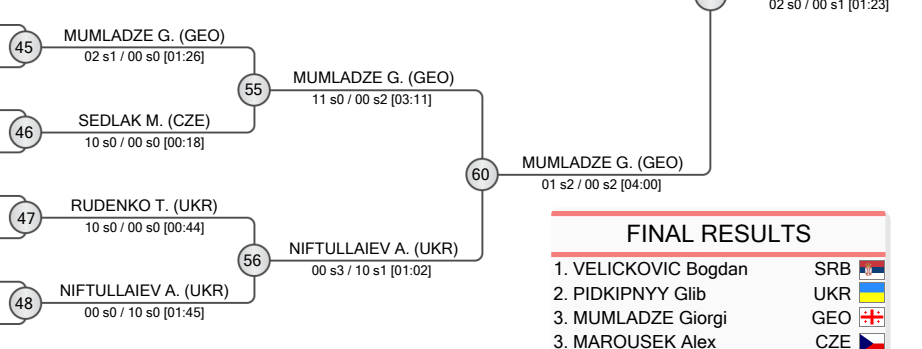

FINAL RESULTS		
1.	VELICKOVIC Bogdan	SRB
2.	PIDKIPNYY Glib	UKR
3.	MUMLADZE Giorgi	GEO
4.	MAROUSEK Alex	CZE
5.	GORUN Volodymyr	UKR
6.	DULARIDZE Lado	GEO
7.	VOLZ Mark	GER
8.	KISS Szabolcs	HUN

REPECHAGE

61	DUBINIENKO Y. (UKR)	61	DUBINIENKO Y. (UKR)
62	MARTINI N. (GER)	62	STOPP P. (HUN)
63	STOPP P. (HUN)	63	DULARIDZE L. (GEO)
64	HERSHCOVITZ N. (ISR)	64	KISS S. (HUN)
	DULARIDZE L. (GEO)		
	KISS S. (HUN)		
	KOBYLINSKI J. (POL)		

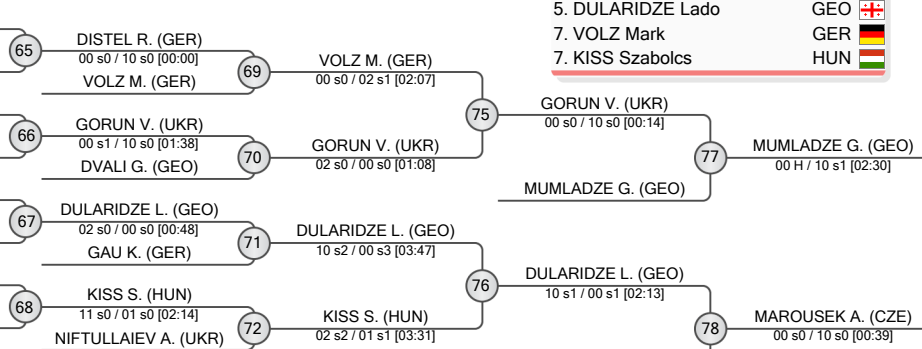



Teplice Cadet European Cup 2024

Czechia, Teplice, 6-7 Apr 2024

-81 kg
Men (41)

POOL A

GER	DISTEL Konstantin	GER
GEO	JAKHVELADZE Saba	GEO
SLO	SRABOTIC Val	SLO
CZE	KUCERA Kristian	CZE
UKR	PEREVERTAILO Kyrilo	UKR
GEO	PAPUKISHVILI David	GEO
GER	KISSK Julian Henryk	GER
HUN	PERECZ Mark	HUN
ROU	IANCU Robert	ROU
POL	SWIDWA Robert	POL

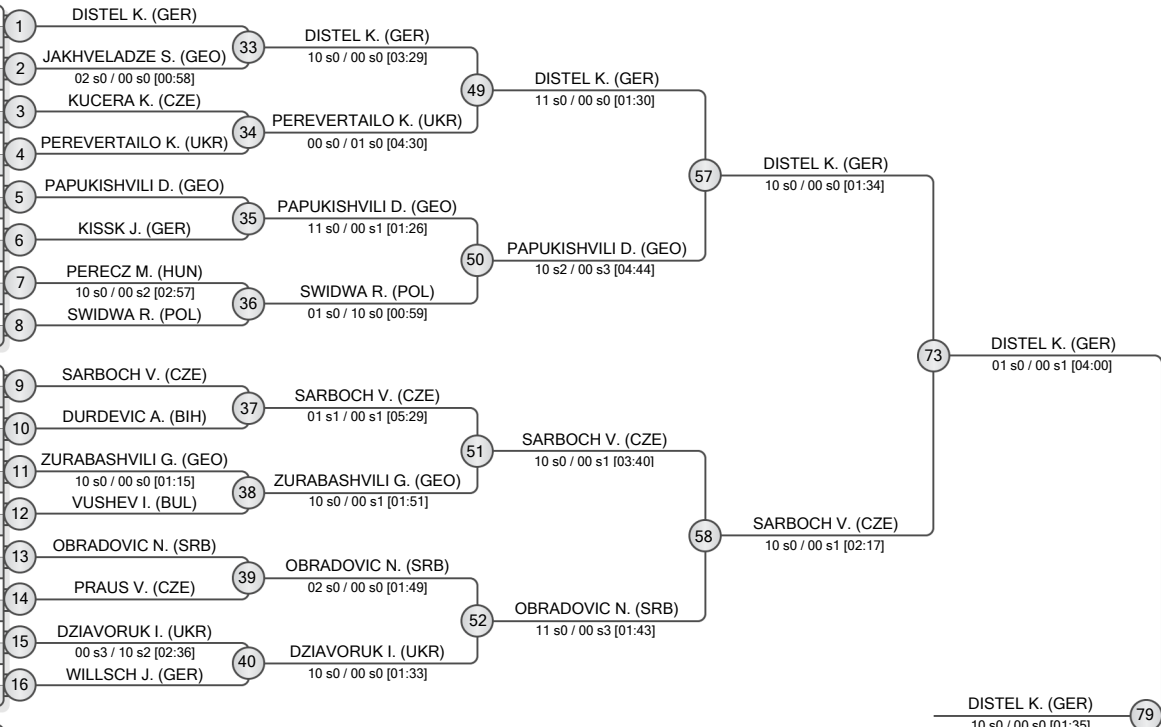

POOL B

CZE	SARBOCH Vit	CZE
BIH	DURDEVIC Adrian	BIH
GEO	ZURABASHVILI Giorgi	GEO
CRO	ZIZAK Nikola	CRO
BUL	VUSHEV Iliyan	BUL
SRB	OBRADOVIC Nikola	SRB
CZE	PRAUS Vitezslav	CZE
ISR	SHNIDER Omer	ISR
UKR	DZIAVORUK Ivan	UKR
GER	WILLSCH Justin	GER

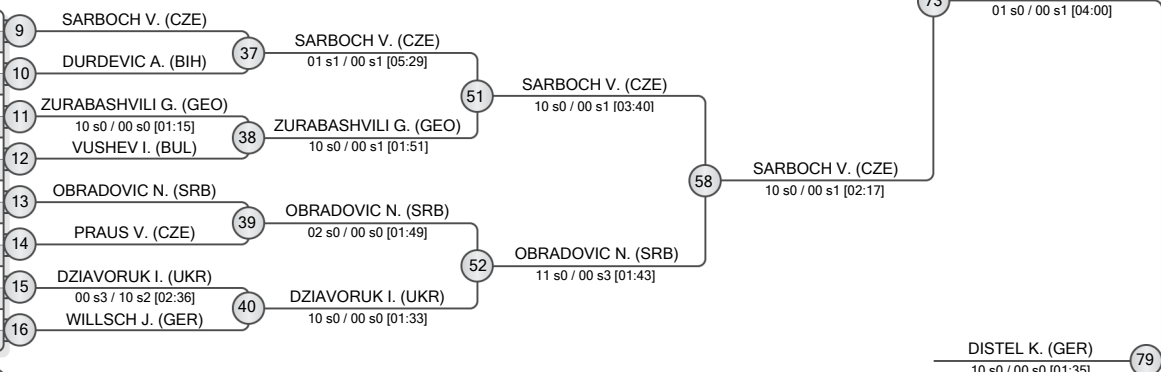

POOL C

GEO	SONGULASHVILI Saba	GEO
UKR	MARACHEV Pylyp	UKR
CZE	KLIMES Vojtech	CZE
GER	RUDI Lennox	GER
ROU	SZABO Bence	ROU
AUT	GREINER Christian	AUT
GER	YAKHNIN Georgy	GER
GEO	DZAGANASHVILI Tsothe	GEO
CZE	SURUVKA Vojtech	CZE
ISR	MOGILNI Kirill	ISR
AUS	KELLY Akos	AUS

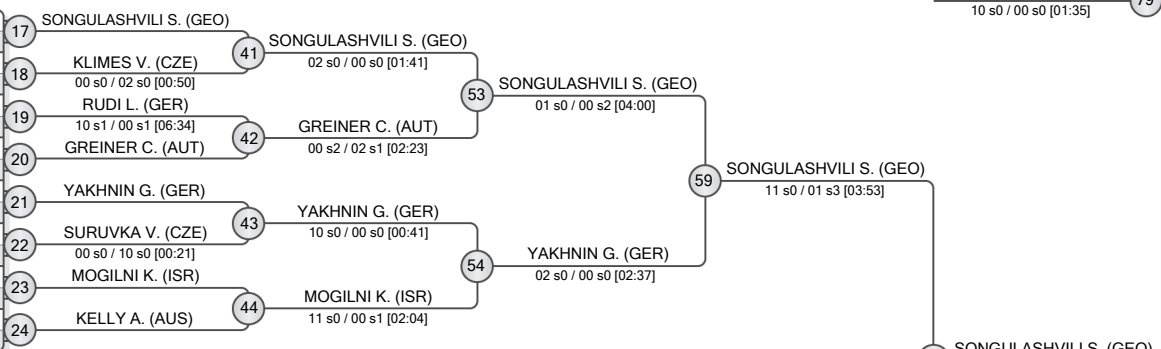

POOL D

UKR	SOLIANYK Mykhailo	UKR
POL	SZCZESNIAK Igor	POL
BUL	DIMITROV Hristo	BUL
GER	KUCHARCZYK Quentin	GER
SVK	HAJNECKY Marec	SVK
CZE	JAKS Adam	CZE
GEO	BAKHTADZE Tsothe	GEO
ROU	NEACSU Rares	ROU
GER	LIBUDA Jan	GER
ISR	ACHLOW Boaz	ISR

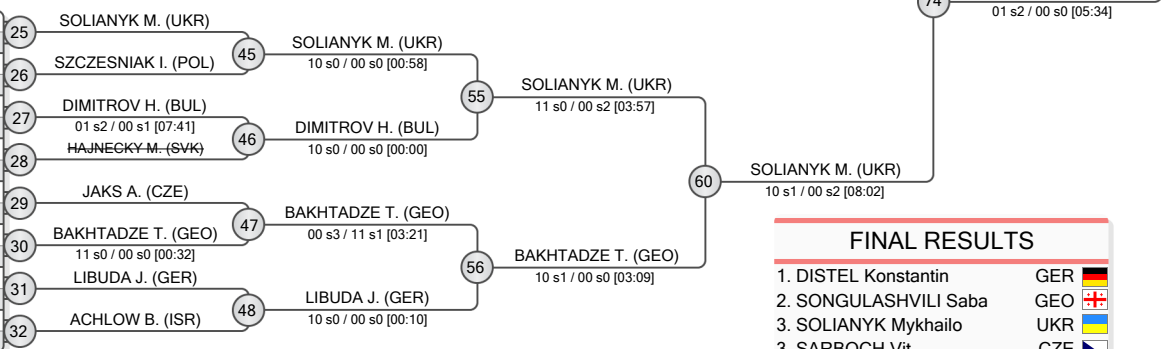

FINAL RESULTS	
1.	DISTEL Konstantin GER
2.	SONGULASHVILI Saba GEO
3.	SOLIANYK Mykhailo UKR
4.	SARBOCH Vit CZE
5.	ZURABASHVILI Giorgi GEO
6.	YAKHNIN Georgy GER
7.	JAKHVELADZE Saba GEO
8.	DIMITROV Hristo BUL

REPECHAGE

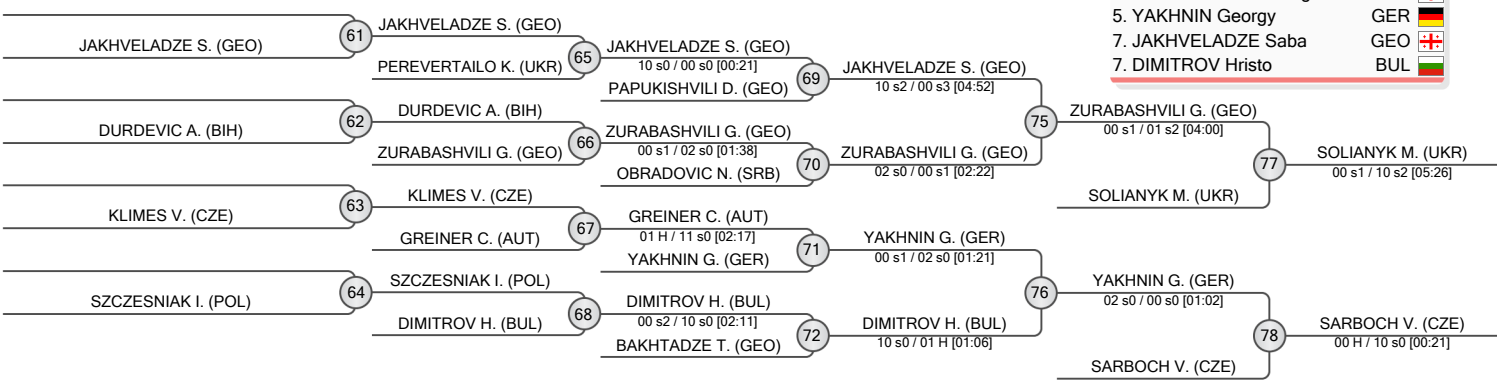



Teplice Cadet European Cup 2024

Czechia, Teplice, 6-7 Apr 2024

-90 kg
Men (27)

POOL A

	SAMOILOV Arkadii	UKR
	RICHTER Mikulas	CZE
	BUTA Denis	ROU
	GELASHVILI Giorgi	GEO
	VALENTIN Jeremy	LUX
	MARKOV Nikola	BUL
	YOLTUKHOVSKIY Stanislav	POR

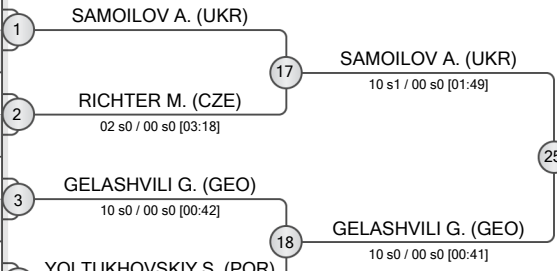

POOL B

	SPYRYDONOV Daniil	UKR
	ANTHONI Oliver	FIN
	HORNGACHER Lorenz	AUT
	FOUKAL Ondrej	CZE
	JIKIA Saba	GEO
	SCHINDLER Lasse Tjark	GER

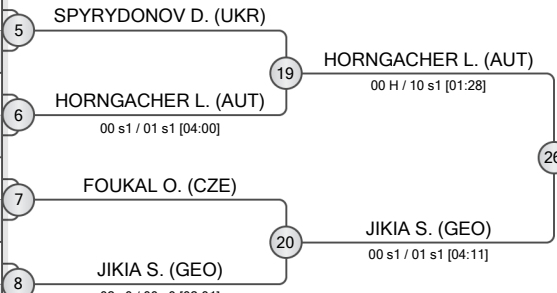

POOL C

	DINCA Alexandru	ROU
	MARGOLIN Alexander Lukas	GER
	KOKHANOVSKIY Stanislav	UKR
	LEBID Dmytro	UKR
	URBAN Matej	CZE
	LIPIC Gabriel	SLO
	DA CRUZ Matteo	LUX

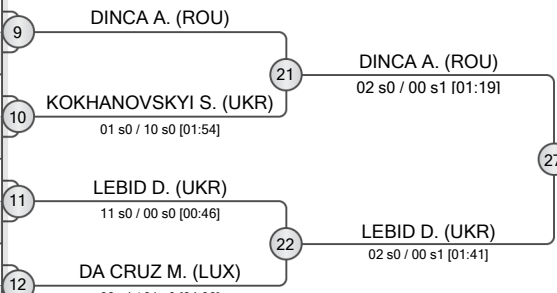

POOL D

	DUR SUN Fatih	TUR
	ROHDE Quint	NED
	BARDIN Thibault	FRA
	SHATAKISHVILI Malkhaz	GEO
	BILOUS Illia	UKR
	MAZYAR Daniel	POR
	BISCHOFF Samuel	GER

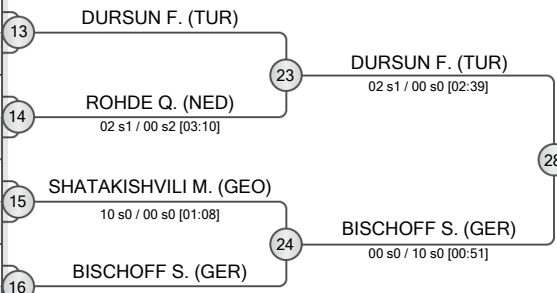

REPECHAGE

29 RICHTER M. (CZE)	30 FOUKAL O. (CZE)	31 DA CRUZ M. (LUX)	32 ROHDE Q. (NED)
33 GELASHVILI G. (GEO)	34 HORNGACHER L. (AUT)	35 DA CRUZ M. (LUX)	36 BISCHOFF S. (GER)

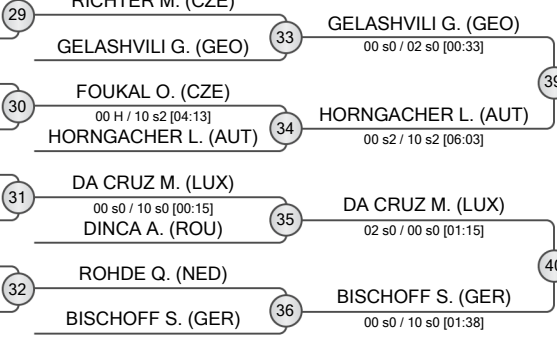

FINAL RESULTS	
1. LEBID Dmytro	UKR
2. JIKIA Saba	GEO
3. GELASHVILI Giorgi	GEO
3. SAMOILOV Arkadii	UKR
5. DUR SUN Fatih	TUR
7. HORNGACHER Lorenz	AUT
7. BISCHOFF Samuel	GER





Teplice Cadet European Cup 2024

Czechia, Teplice, 6-7 Apr 2024

+ 90 kg
Men (20)

POOL A

	KOBALADZE Nodar	GEO
	BURES Adam	CZE
	TUGUI David	ROU
	KHACHATRYAN Anton	POL
	DAMM Felix	GER

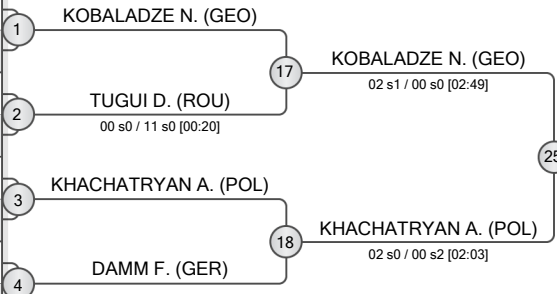

POOL B

	GHAZARYAN Vardges	AUT
	KAGAN BARNEA Lotam	ISR
	TRUHLAR Martin	CZE
	ABALAKI Ioane	GEO
	LUBURA Nikola	BIH

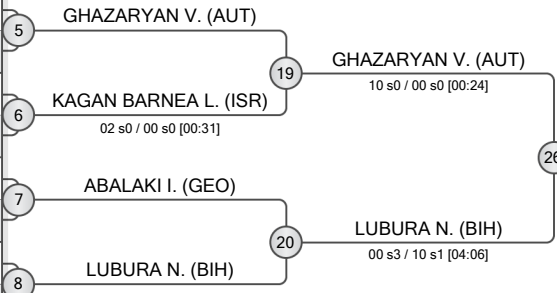

POOL C

	WILHELM Christian	GER
	ANGERER Lukas	AUT
	SZEKERES Abel	HUN
	STANEV Zdravko	BUL
	MADEN Mahmutcan	TUR

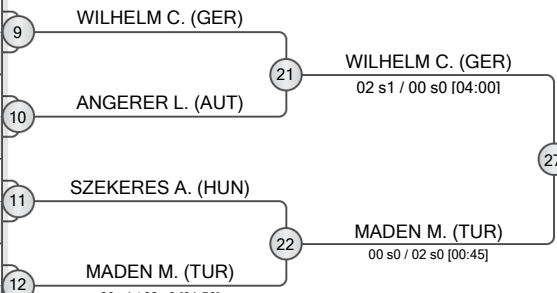

POOL D

	FESENKO Oleh	UKR
	PUSNIK Ian	SLO
	LIUBIMOVSKI Daniel	USA
	KARCHAIDZE Giorgi	GEO
	SKODA Melichar	CZE

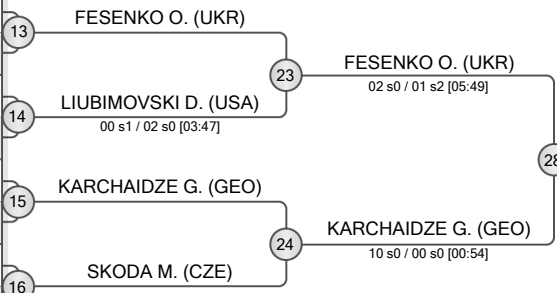

REPECHAGE

	TUGUI D. (ROU)	29	TUGUI D. (ROU)	33
	KHACHATRYAN A. (POL)			
	KAGAN BARNEA L. (ISR)	30	KAGAN BARNEA L. (ISR)	34
	LUBURA N. (BIH)			
	ANGERER L. (AUT)	31	ANGERER L. (AUT)	35
	MADEN M. (TUR)			
	LIUBIMOVSKI D. (USA)	32	KARCHAIDZE G. (GEO)	36
	KARCHAIDZE G. (GEO)			

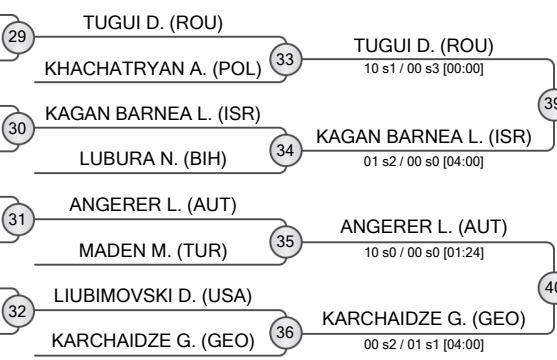

KOBALADZE N. (GEO) 43
01 s1 / 00 s2 [04:15]

FESENKO O. (UKR) 38
00 s1 / 01 s0 [04:00]

FINAL RESULTS	
1. KOBALADZE Nodar	GEO
2. FESENKO Oleh	UKR
3. TUGUI David	ROU
3. GHAZARYAN Vardges	AUT
5. WILHELM Christian	GER
7. KARCHAIDZE Giorgi	GEO
7. ANGERER Lukas	AUT



POOL A

	WALENDZIK Sandra	POL
	NAGY Talida Ariella	ROU

1

WALENDZIK S. (POL)

10 s0 / 00 s0 [00:23]

POOL B

	TANACKOV Marija	SRB
	PEETERS Fenne	BEL

2

PEETERS F. (BEL)

00 H / 10 s1 [02:44]

POOL C

	ABDULLAYEVA Khadija	AZE
	URBAN Noemie	FRA

3

ABDULLAYEVA K. (AZE)

01 s2 / 00 s2 [04:00]

POOL D

	COSKUN Busra Ceylin	TUR
	TAKACS Nora	HUN

4

COSKUN B. (TUR)

10 s0 / 00 s0 [00:42]

5

WALENDZIK S. (POL)

10 s1 / 00 s1 [04:33]

6

ABDULLAYEVA K. (AZE)

10 s2 / 00 s3 [06:53]

11

WALENDZIK S. (POL)

10 s1 / 00 s2 [03:15]

REPECHAGE

NAGY T. (ROU)

TANACKOV M. (SRB)

7

TANACKOV M. (SRB)

00 s1 / 11 s0 [01:59]

9

TANACKOV M. (SRB)

10 s1 / 00 s0 [03:42]

URBAN N. (FRA)

TAKACS N. (HUN)

8

URBAN N. (FRA)

10 s0 / 00 s1 [01:29]

10

PEETERS F. (BEL)

10 s1 / 00 s0 [03:42]

FINAL RESULTS		
1.	WALENDZIK Sandra	POL
2.	ABDULLAYEVA Khadija	AZE
3.	TANACKOV Marija	SRB
3.	PEETERS Fenne	BEL
5.	COSKUN Busra Ceylin	TUR
5.	URBAN Noemie	FRA



Teplice Cadet European Cup 2024

Czechia, Teplice, 6-7 Apr 2024

-44 kg
Women (12)

POOL A

	TOMANKOVA Patricia	SVK
	PETRENKO Liliia	UKR
	CRIVELLARO Noemi	GER

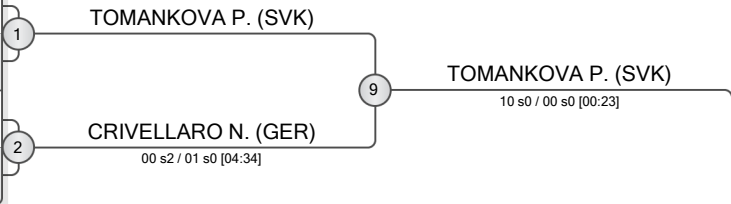

POOL B

	AUER Nina	AUT
	GRIGOROVA Kalina	BUL
	PAPAI Stella	HUN

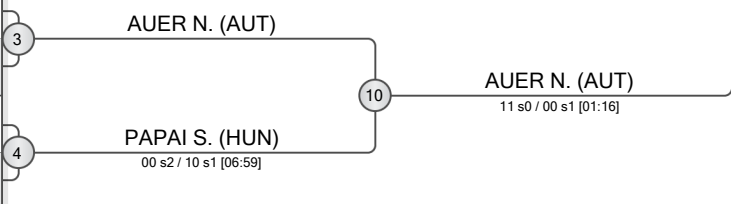

POOL C

	POTOK Natasza	POL
	SERBAN Denisa	ROU
	KAYIR Livanur	TUR

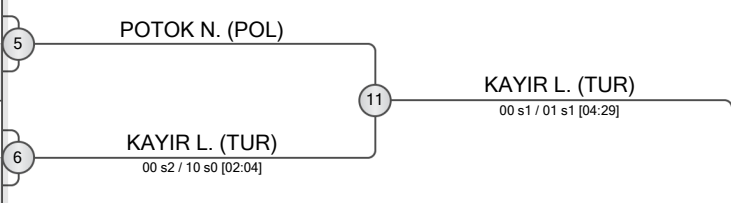

POOL D

	PROLIC Natalija	SRB
	ALAKBAROVA Leyla	AZE
	VASILEVA Raya	BUL

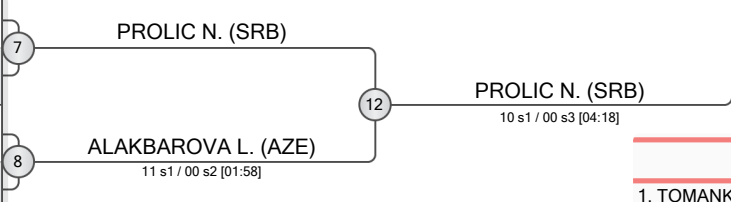

FINAL RESULTS		
1.	TOMANKOVA Patricia	SVK
2.	PROLIC Natalija	SRB
3.	KAYIR Livanur	TUR
3.	AUER Nina	AUT
5.	PAPAI Stella	HUN
5.	ALAKBAROVA Leyla	AZE
7.	CRIVELLARO Noemi	GER
7.	SERBAN Denisa	ROU

REPECHAGE

13	CRIVELLARO N. (GER)
14	PAPAI S. (HUN)
15	SERBAN D. (ROU)
15	POTOK N. (POL)
16	ALAKBAROVA L. (AZE)

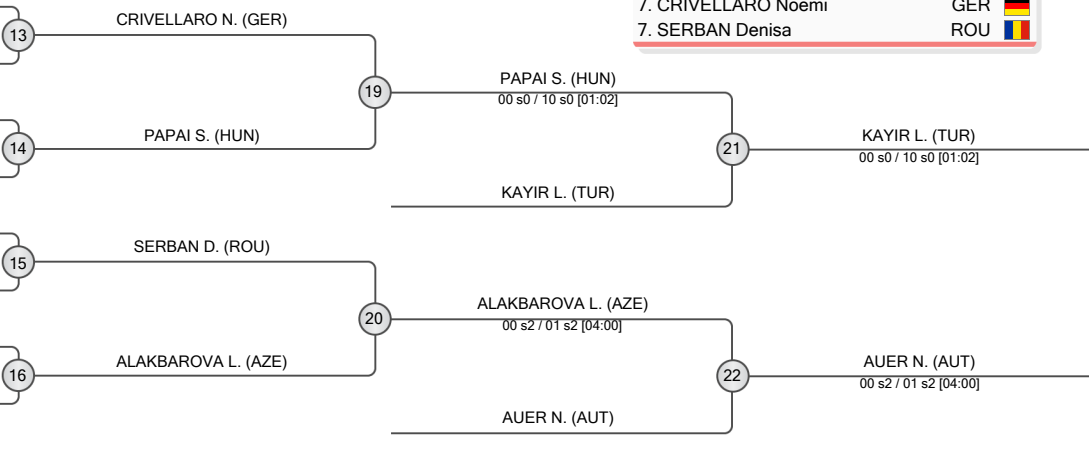



Teplice Cadet European Cup 2024

Czechia, Teplice, 6-7 Apr 2024

-48 kg
Women (34)

POOL A

1	TOURNIER Maelie (AUS)	1	TOURNIER M. (AUS)
2	HAJIZADA Nurana (AZE)	2	HAJIZADA N. (AZE)
3	KUBERSKY Lia (ISR)	3	TUMKO P. (UKR)
4	TUMKO Polina (UKR)	4	MAYRHOFER L. (AUT)
5	MAYRHOFER Lena (AUT)	5	KOYAK A. (TUR)
6	KOYAK Aleyna Sena (TUR)	6	POSPILOVA A. (CZE)
7	POSPILOVA Adela (CZE)	7	WAMHOF M. (GER)
8	WAMHOF Matilda (GER)	8	MUNTEANU Ana Maria (ROU)

POOL B

9	KILIC Elif (TUR)	9	KILIC E. (TUR)
10	IATAGAN Maria (ROU)	10	IATAGAN M. (ROU)
11	ANTOVA Zoya (BUL)	11	ANTOVA Z. (BUL)
12	RIDDERSKAMP Helke (GER)	12	RIDDERSKAMP H. (GER)
13	KRIZOVA Kristina Lili (SVK)	13	KRIZOVA K. (SVK)
14	SAMEC Nusa (SLO)	14	SAMEC N. (SLO)
15	ESHTEL Carmel (ISR)	15	ESHTEL C. (ISR)
16	NETTESHEIM Charlotte (GER)	16	NETTESHEIM C. (GER)

POOL C

17	LEVCHENKO Anastasiia (UKR)	17	LEVCHENKO A. (UKR)
18	SPICKOVA Sofie (CZE)	18	SPICKOVA S. (CZE)
19	BAR LEV Ella (ISR)	19	BAR LEV E. (ISR)
20	PEREIRA Mariana (POR)	20	PEREIRA M. (POR)
21	MANDA Lorena (ROU)	21	MANDA L. (ROU)
22	NEVO Liri (ISR)	22	KOVACHEVA P. (BUL)
23	KOVACHEVA Preslava (BUL)	23	PLICH E. (GER)
24	PLICH Emily Chiara (GER)	24	SLOTH HANSEN Alice (DEN)

POOL D

25	KISS Viktoria (HUN)	25	KISS V. (HUN)
26	TOMESCU Yasmine (ROU)	26	TOMESCU Y. (ROU)
27	PRITULEAC Iana (MDA)	27	PRITULEAC I. (MDA)
28	ZOCH Florentine (GER)	28	ZOCH F. (GER)
29	HADAR Noa (ISR)	29	HADAR N. (ISR)
30	MINASYAN Tatevik (AUT)	30	MINASYAN T. (AUT)
31	EYVAZLI Konul (AZE)	31	EYVAZLI K. (AZE)
32	SARAH Gueth (GER)	32	SARAH G. (GER)

REPECHAGE

61	TOURNIER M. (AUS)	61	TOURNIER M. (AUS)
62	IATAGAN M. (ROU)	62	IATAGAN M. (ROU)
63	BAR LEV E. (ISR)	63	BAR LEV E. (ISR)
64	TOMESCU Y. (ROU)	64	TOMESCU Y. (ROU)

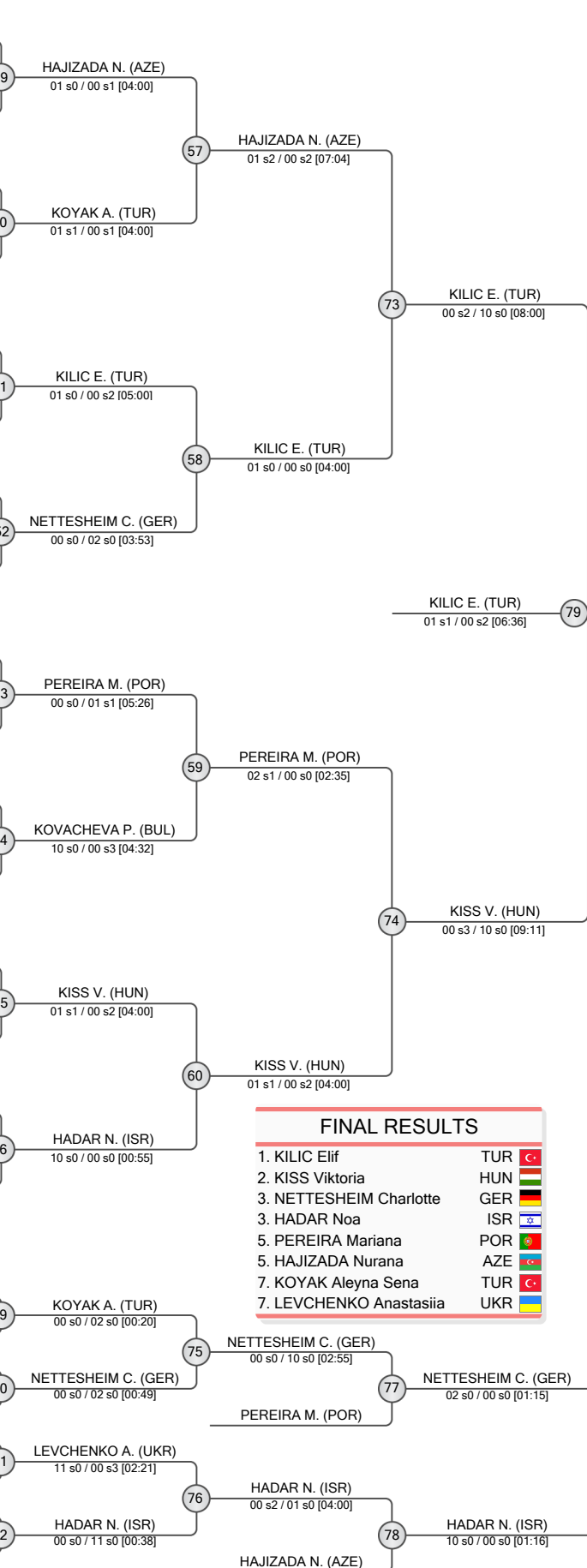



Teplice Cadet European Cup 2024

Czechia, Teplice, 6-7 Apr 2024

-52 kg

Women (38)

POOL A

1	BANNISTER Callie AUS	BANNISTER C. (AUS)
2	TEISANU Teodora ROU	TEISANU T. (ROU)
3	JIRASKOVA Darina CZE	JIRASKOVA D. (CZE)
4	TUZ Diana UKR	TUZ D. (UKR)
5	KRUTSCH Laura GER	KRUTSCH L. (GER)
6	VODIANNA Melaniia UKR	VODIANNA M. (UKR)
7	MAMMADOVA Aysun AZE	MAMMADOVA A. (AZE)
8	SZABO Reka HUN	SZABO R. (HUN)
9	VADOVICOVA Vivien SVK	VADOVICOVA V. (SVK)
10	SCHEINER Gal ISR	SCHEINER G. (ISR)

POOL B

9	HAJIYEVA Vusala AZE	HAJIYEVA V. (AZE)
10	BALIC Lucija CRO	BALIC L. (CRO)
11	BECKER Libi ISR	BECKER L. (ISR)
12	STOEVA Andrea BUL	STOEVA A. (BUL)
13	STORM Sophia Grace GER	STORM S. (GER)
14	VAS Mira HUN	VAS M. (HUN)
15	SEVERYN Anastasiia UKR	SEVERYN A. (UKR)
16	KEJDOVA Emma CZE	KEJDOVA E. (CZE)
17	BESTAV Selin TUR	BESTAV S. (TUR)

POOL C

17	BARISIC Laura CRO	BARISIC L. (CRO)
18	BAUER Susanne AUT	BAUER S. (AUT)
19	YEMELIANOVA Yelyzaveta UKR	YEMELIANOVA Y. (UKR)
20	BIRTU Alexia Andreea ROU	BIRTU A. (ROU)
21	JUTTNER Janka HUN	JUTTNER J. (HUN)
22	YUSIFLI Samaya AZE	YUSIFLI S. (AZE)
23	HULOVA Karolina CZE	HULOVA K. (CZE)
24	KOAR Lindsay Maria GER	KOAR L. (GER)
25	OZ Dilara TUR	OZ D. (TUR)

POOL D

25	BERRIOT Eilys FRA	BERRIOT E. (FRA)
26	RUSTAMOVA Aliya AZE	RUSTAMOVA A. (AZE)
27	JOVANOVIC Jana SRB	JOVANOVIC J. (SRB)
28	URBAN Pia GER	URBAN P. (GER)
29	YAHAV Yali ISR	YAHAV Y. (ISR)
30	ERTEN Klara GER	ERTEN K. (GER)
31	CORDOVA Sofia SWE	CORDOVA S. (SWE)
32	MOHAROS Zsofia HUN	MOHAROS Z. (HUN)
33	VONDRAKOVA Lada CZE	VONDRAKOVA L. (CZE)
34	MOMOT Neonila UKR	MOMOT N. (UKR)

REPECHAGE

61	TEISANU T. (ROU)	TEISANU T. (ROU)
62	SEVERYN A. (UKR)	SEVERYN A. (UKR)
63	BIRTU A. (ROU)	BIRTU A. (ROU)
64	ERTEN K. (GER)	ERTEN K. (GER)
65	KRUTSCH L. (GER)	KRUTSCH L. (GER)
66	BESTAV S. (TUR)	BESTAV S. (TUR)
67	BARISIC L. (CRO)	BARISIC L. (CRO)
68	VONDRAKOVA L. (CZE)	VONDRAKOVA L. (CZE)
69	SCHEINER G. (ISR)	SCHEINER G. (ISR)
70	BECKER L. (ISR)	BECKER L. (ISR)
71	JUTTNER J. (HUN)	JUTTNER J. (HUN)
72	YAHAV Y. (ISR)	YAHAV Y. (ISR)

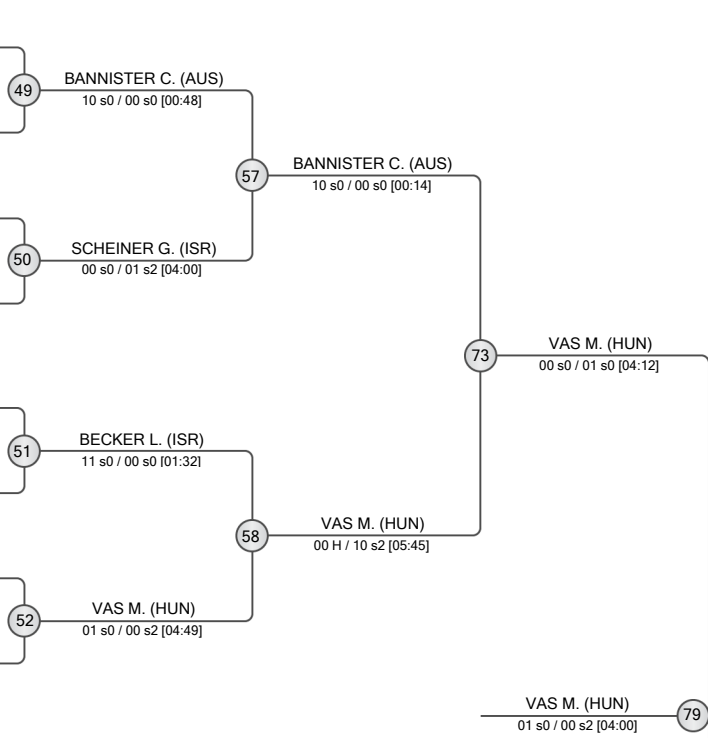

FINAL RESULTS	
1.	VAS Mira HUN
2.	YEMELIANOVA Yelyzaveta UKR
3.	CORDOVA Sofia SWE
3.	JUTTNER Janka HUN
5.	SEVERYN Anastasiia UKR
5.	BANNISTER Callie AUS
7.	SCHEINER Gal ISR
7.	VONDRAKOVA Lada CZE





Teplice Cadet European Cup 2024

Czechia, Teplice, 6-7 Apr 2024

-57 kg

Women (40)

POOL A

	ZAKROISKY Hili	ISR	1
	REINHOLD Jolina	GER	2
	ERIC Lana	BIH	3
	SCHWARZBAUER Carina	AUT	4
	PAVEN Amelia	ROU	5
	KAISER Katharina	GER	6
	BABULFATH Hanna	SWE	7
	MAJ Veronika	HUN	8
	SOCOLSKY Adi	ISR	9
	SAFRANKOVA Nikola	CZE	10

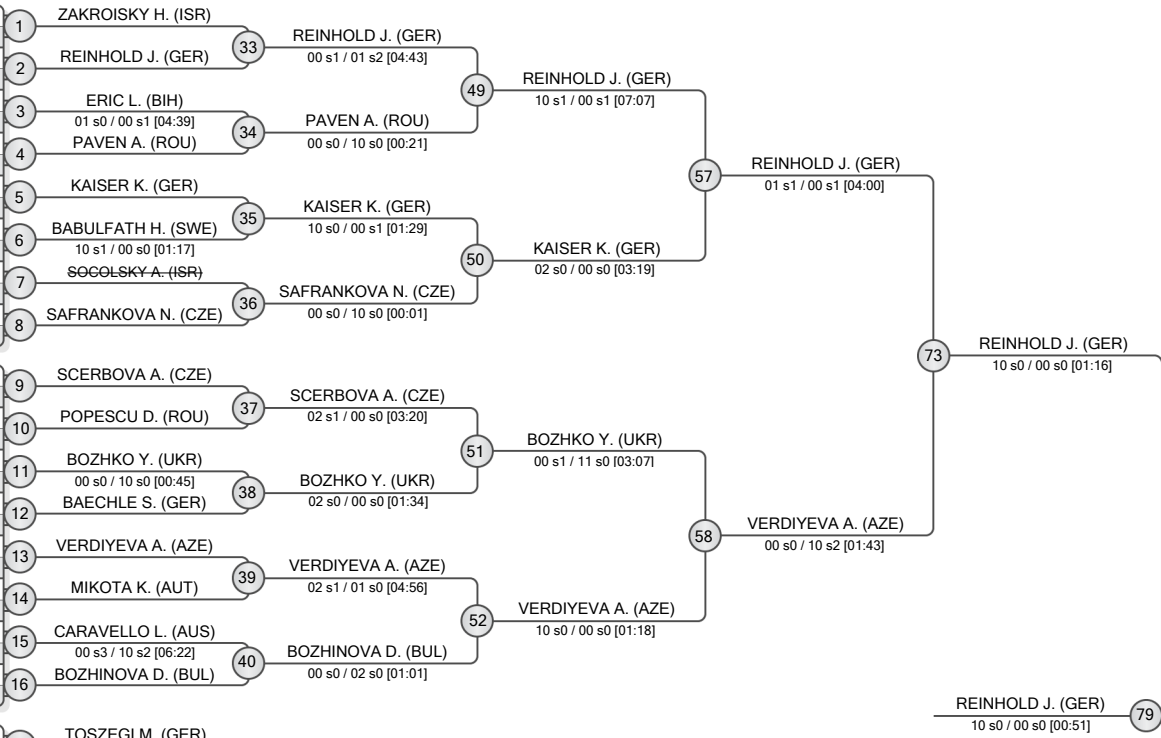

POOL B

	SCERBOVA Amalie	CZE	9
	POPESCU Daliana	ROU	10
	ELISHA Keshet	ISR	11
	BOZHKO Yelyzaveta	UKR	12
	BAECHLE Sophia	GER	13
	VERDIYEVA Aytan	AZE	14
	MIKOTA Katharina	AUT	15
	HERMANOVA Karolina	CZE	16
	CARAVELLO Lisa	AUS	17
	BOZHINOVA Denitsa	BUL	18

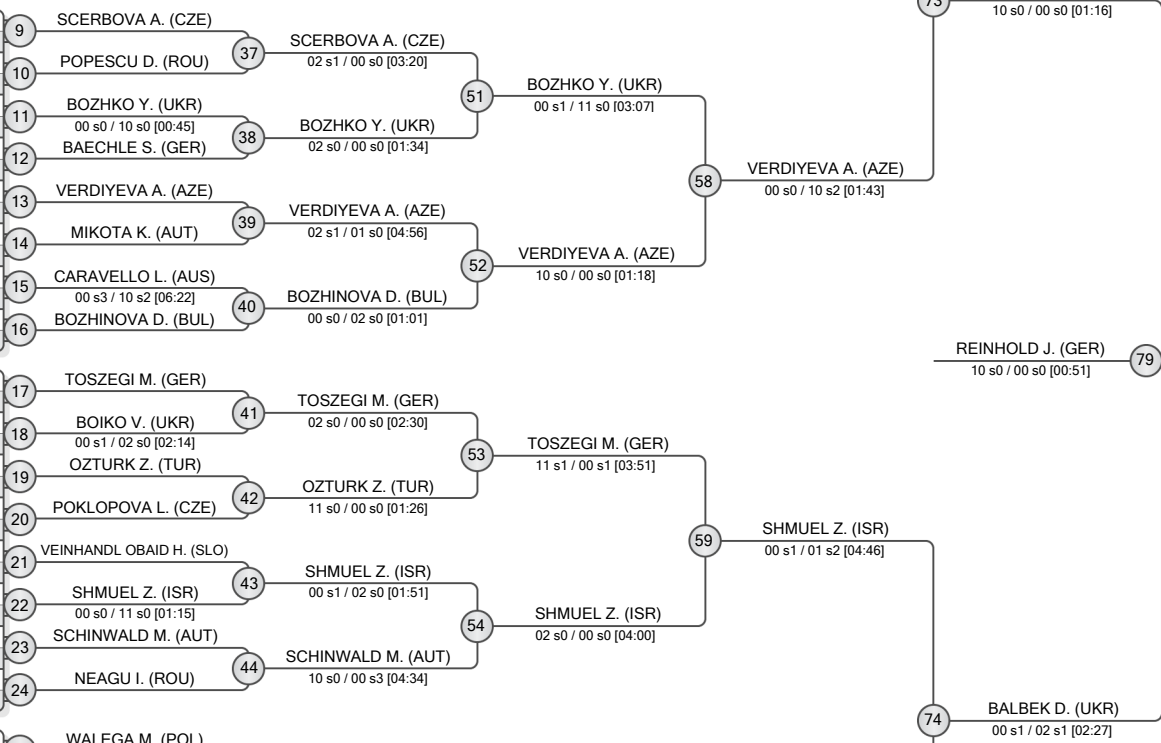

POOL C

	TOSZEGI Maya	GER	17
	MACOVEI Laura	POR	18
	BOIKO Veronika	UKR	19
	OZTURK Zeynep	TUR	20
	POKLOPOVA Lucie	CZE	21
	VEINHANDL OBAID Haya	SLO	22
	SPECHT Nelly	GER	23
	SHMUEL Zohar	ISR	24
	SCHINWALD Marlene	AUT	25
	NEAGU Isabela Ioana	ROU	26

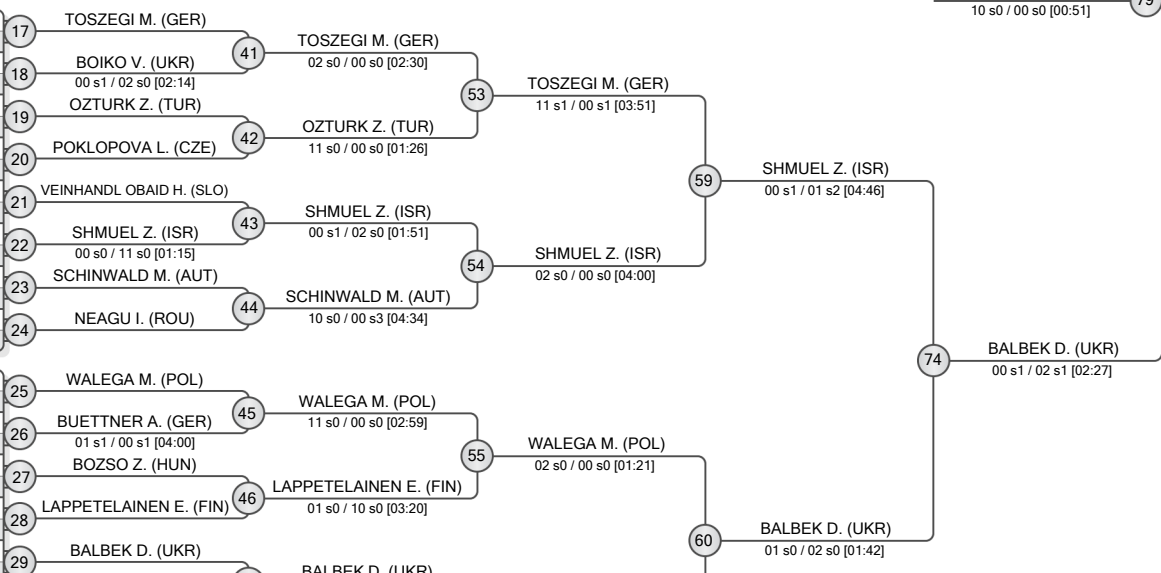

POOL D

	WALEGA Magdalena	POL	25
	BUETTNER Alesia	GER	26
	RZAYEVA Nilgun	AZE	27
	BOZSO Zita	HUN	28
	LAPPETELAINEN Essi	FIN	29
	BALBEK Diana	UKR	30
	SCHOONEN Liv	NED	31
	HALLER Eva	AUT	32
	CEPELAKOVA Lucie	CZE	33
	PERY Noa	ISR	34

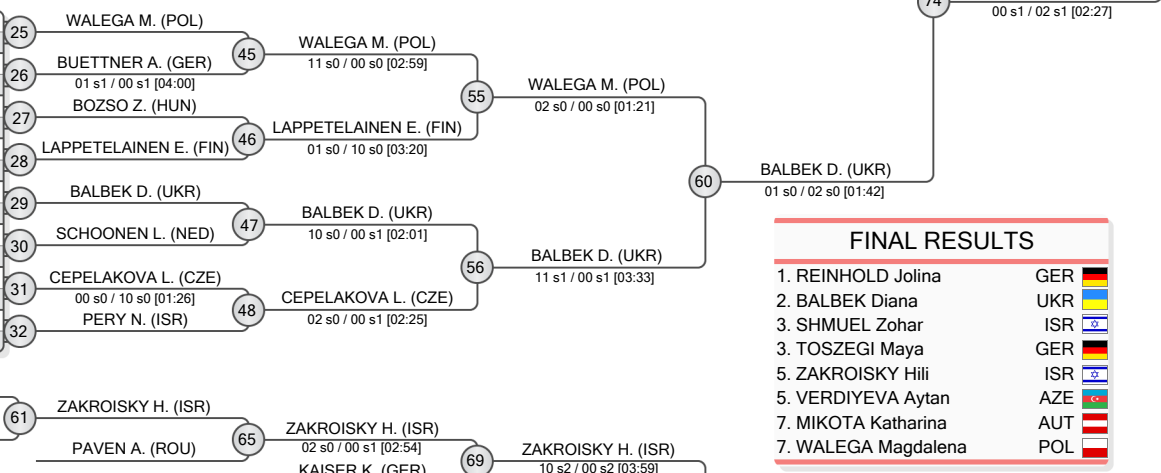

FINAL RESULTS		
1.	REINHOLD Jolina	GER
2.	BALBEK Diana	UKR
3.	SHMUEL Zohar	ISR
3.	TOSZEGI Maya	GER
5.	ZAKROISKY Hili	ISR
5.	VERDIYEVA Aytan	AZE
7.	MIKOTA Katharina	AUT
7.	WALEGA Magdalena	POL

REPECHAGE

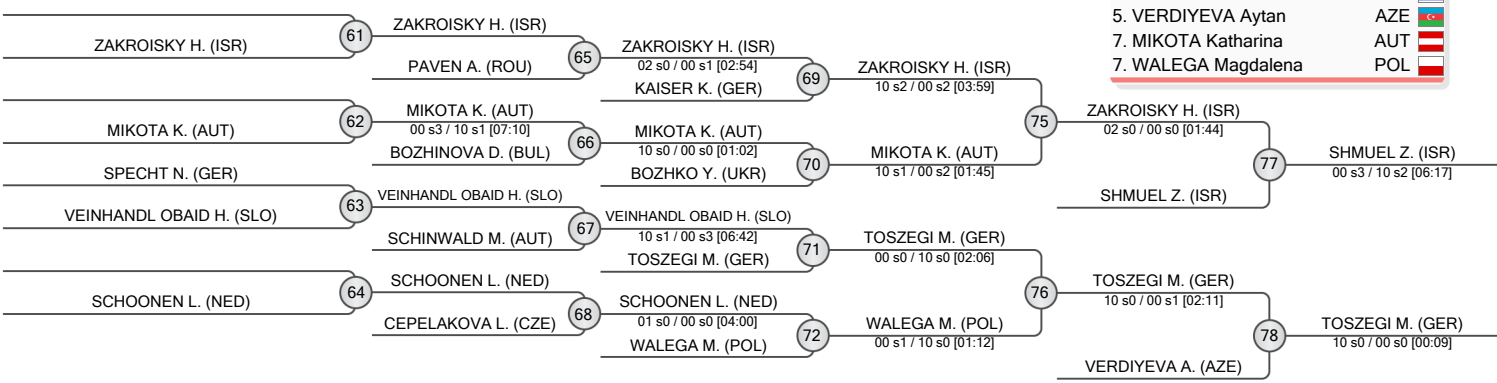



Teplice Cadet European Cup 2024

Czechia, Teplice, 6-7 Apr 2024

-63 kg
Women (39)

POOL A

	TSURKAN Ilariia	UKR
	ROEMMER Amelie	GER
	JURCIKOVA Viktorie	CZE
	BACHLER Anna	AUT
	BESKER Ana	CRO
	SISKOVA Stela	CZE
	JALILLI Fidan	AZE
	SCHLIEPER Carlotta	GER
	TSENOVA Aleksandra	BUL

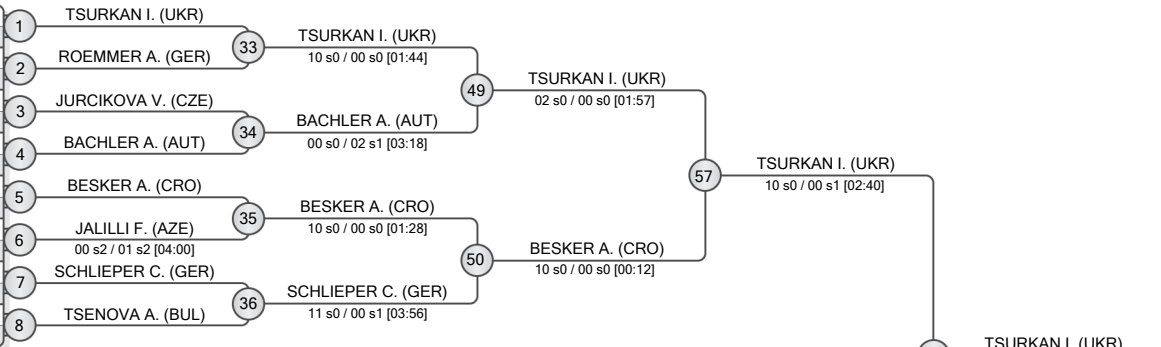

POOL B

	SCHENK Magdalena	POL
	WOLSFELD Sara-Tamar	GER
	SCHIPPER Yael	NED
	DRAHOŠOVA Viktorie	CZE
	HORVAT Veronika	SLO
	BOB Isabel	ROU
	JOTA Matilde	POR
	SOTNYK Viktoriia	UKR
	TAKACS Sara	HUN
	STEINEBRUNNER Salome	GER

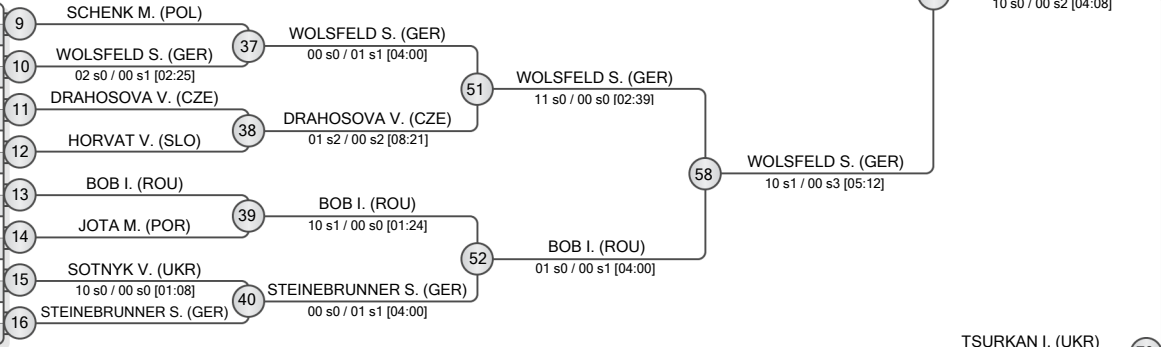

POOL C

	HANNA Zaitseva	POL
	ERGEN Fulya	TUR
	GOTTSCHALK Hedda	GER
	GUDDENS Senna	NED
	VLKOVA Eliška	CZE
	HOO Fedra	HUN
	IHNACAKOVA Sara	CZE
	RABL Mavie	AUT
	VOZNIUK Liudmyla	UKR
	BARTZ Livia	GER

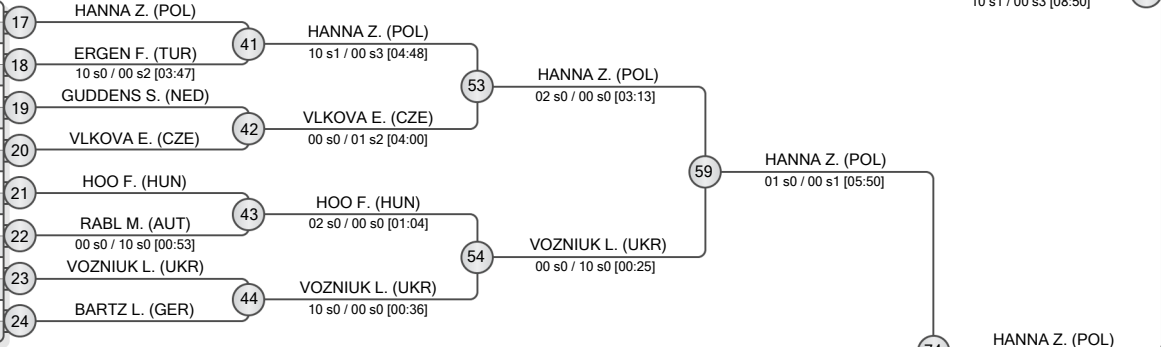

POOL D

	KONRAD Sveyarike	GER
	PAVLOVIC Nevena	SRB
	SIKOSK Ajda	SLO
	WOZNICZKO Nadia	POL
	SEMOUD Luna	GER
	OPANASENKO Kristina	UKR
	JANCIKOVA Monika	CZE
	LEHMANN Malou	GER
	ADAMACHI Maya	ROU
	BAYRAMLI Malak	AZE

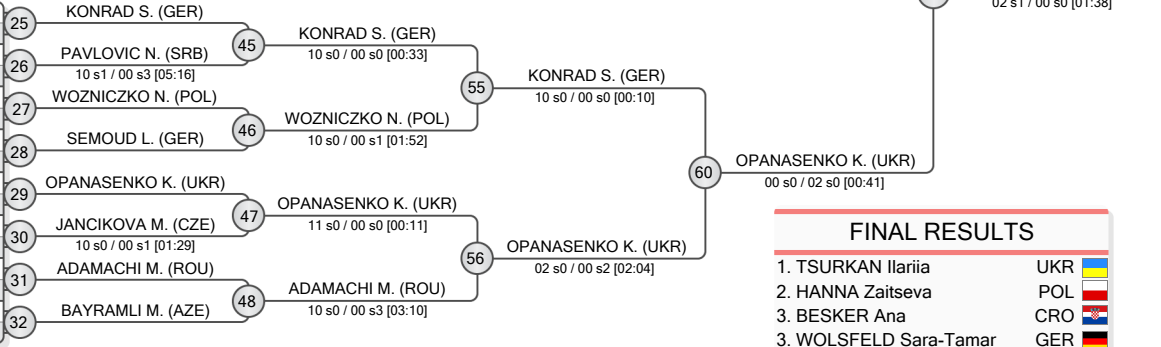

FINAL RESULTS		
1.	TSURKAN Ilariia	UKR
2.	HANNA Zaitseva	POL
3.	BESKER Ana	CRO
3.	WOLSFELD Sara-Tamar	GER
5.	OPANASENKO Kristina	UKR
5.	VOZNIUK Liudmyla	UKR
7.	BOB Isabel	ROU
7.	KONRAD Sveyarike	GER

REPECHAGE

	ROEMMER A. (GER)	61
	SCHIPPER Y. (NED)	62
	ERGEN F. (TUR)	63
	JANCIKOVA M. (CZE)	64
	BACHLER A. (AUT)	65
	SCHENK M. (POL)	66
	ERGEN F. (TUR)	67
	JANCIKOVA M. (CZE)	68

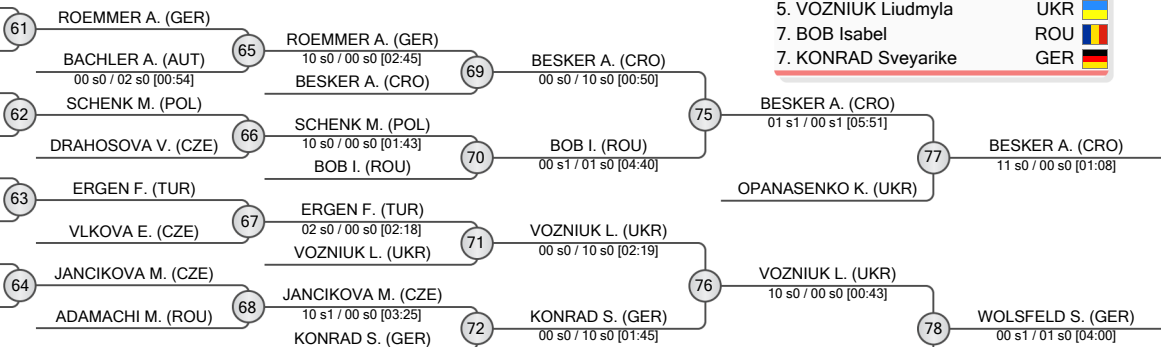



Teplice Cadet European Cup 2024

Czechia, Teplice, 6-7 Apr 2024

-70 kg
Women (29)

POOL A

	OLIINYK-KORNIKO Anna	UKR
	SIMUNKOVA Adela	CZE
	FEHER Zara	ROU
	KRUPL Georgina	HUN
	DE KOCK Luna	NED
	HUDIKA Vita	CRO
	KRAMKOWSKY Pia-Kristin	GER

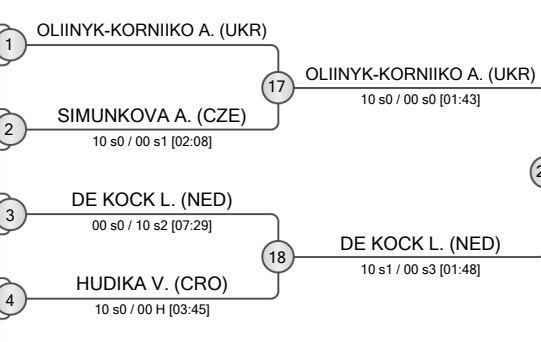

POOL B

	USURELU Alexia	ROU
	SMUSZOVA Jirina	CZE
	MUELLER Hannah	GER
	ZONGUR Ayse	TUR
	PROELL Claire	AUT
	TITOVETS Kira	UKR
	SARKOZI Zsuzsa	HUN
	AHMADOVA Rena	AZE

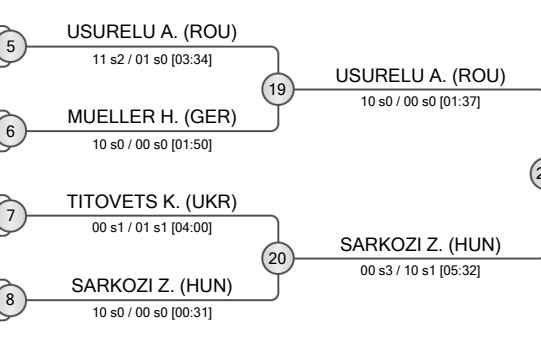

POOL C

	JAAFAR Nadie	BUL
	OZIUMENKO Halyna	UKR
	SUCIU Anamaria	ROU
	APOSTOLOVA Emili	BUL
	MCHENRY Hannah	AUS
	KNAFELC Noeli	SLO
	MANUKYAN Mia	GER

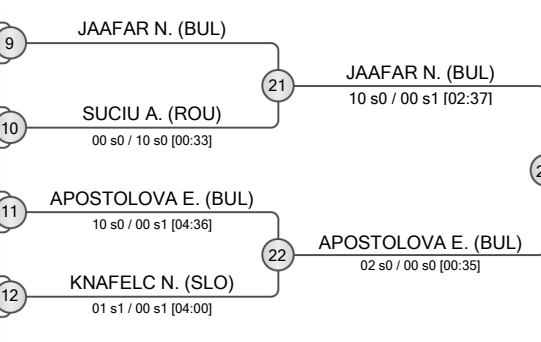

POOL D

	SKORUPIŃSKA Martyna	POL
	NEUBERT Lara	GER
	EICHMULLER Boglarka	HUN
	MICIC Una	BIH
	TKACHOVA Anna	UKR
	OMACKOVA Amalie	CZE
	PAVIC Lucia	SRB

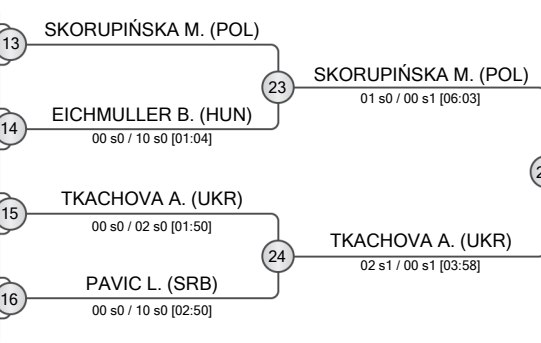

FINAL RESULTS		
1.	OLIINYK-KORNIKO Anna	UKR
2.	APOSTOLOVA Emili	BUL
3.	SKORUPIŃSKA Martyna	POL
3.	TKACHOVA Anna	UKR
5.	SIMUNKOVA Adela	CZE
5.	SARKOZI Zsuzsa	HUN
7.	USURELU Alexia	ROU
7.	JAAFAR Nadie	BUL

REPECHAGE

SIMUNKOVA A. (CZE) 29	SIMUNKOVA A. (CZE)
AHMADOVA R. (AZE) 30	TITOVETS K. (UKR) 00 s0 / 11 s0 [00:31]
TITOVETS K. (UKR) 30	USURELU A. (ROU)
MCHENRY H. (AUS) 31	KNAFELC N. (SLO) 00 s0 / 10 s1 [01:28]
KNAFELC N. (SLO) 31	JAAFAR N. (BUL)
EICHMULLER B. (HUN) 32	EICHMULLER B. (HUN)
EICHMULLER B. (HUN) 32	TKACHOVA A. (UKR)

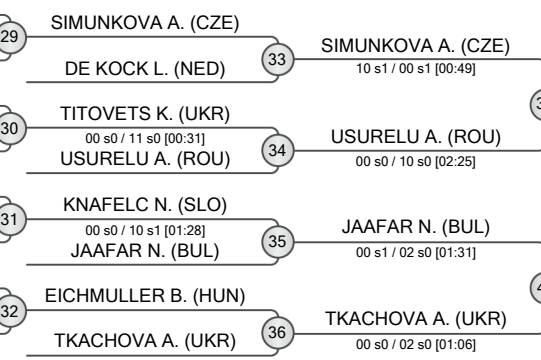



Teplice Cadet European Cup 2024

Czechia, Teplice, 6-7 Apr 2024

+ 70 kg
Women (20)

POOL A

	BANASZEWSKA Zuzanna	POL
	PODZEMNA Zuzana	CZE
	MONDOK Viktoria	HUN
	ZAREBA Nikola	POL
	SOTSKA Tetiana	UKR

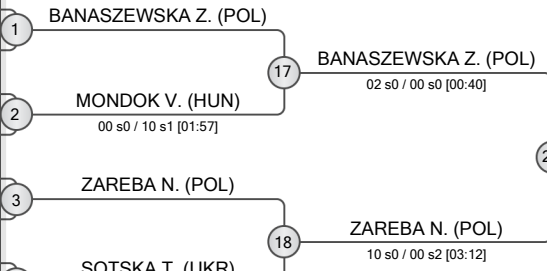

POOL B

	COCIORBA Ioana	ROU
	HOELLWART Michaela	AUT
	PFISTER Arlette	GER
	METE Sema	TUR
	SAJTOVIC Matea	CRO

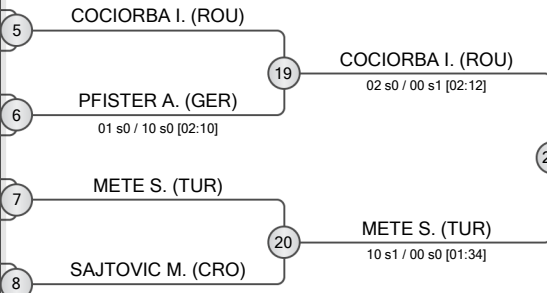

POOL C

	KASZPEROVA Kristyna	CZE
	DILGER Elina	GER
	SKRABAN Lana	SLO
	KROUZKOVA Anna	CZE
	KUBYNETS Kristina	UKR

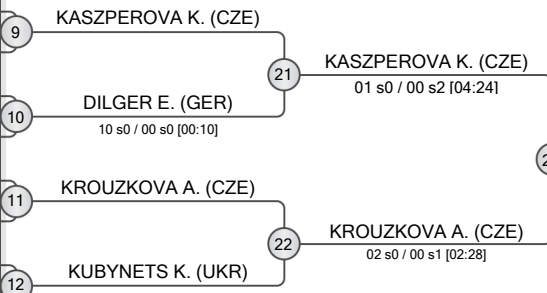

POOL D

	FILKOROVA Nina	SVK
	AMICO Eva	BUL
	HARTMEIJER Lindey	NED
	PRUESSE Elina	GER
	KUPRIKOVA Daryna	UKR

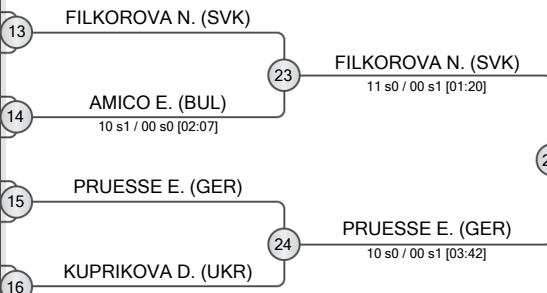

REPECHAGE

	MONDOK V. (HUN)	29	MONDOK V. (HUN)	33
	SAJTOVIC M. (CRO)	30	SAJTOVIC M. (CRO)	34
	DILGER E. (GER)	31	DILGER E. (GER)	35
	AMICO E. (BUL)	32	AMICO E. (BUL)	36

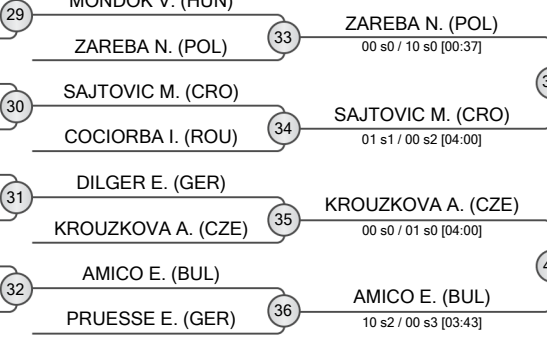

BANASZEWSKA Z. (POL) 43
02 s0 / 00 s2 [02:34]

FINAL RESULTS		
1.	BANASZEWSKA Zuzanna	POL
2.	KASZPEROVA Kristyna	CZE
3.	ZAREBA Nikola	POL
3.	METE Sema	TUR
5.	FILKOROVA Nina	SVK
5.	KROUZKOVA Anna	CZE
7.	SAJTOVIC Matea	CRO
7.	AMICO Eva	BUL

