



Samorin Cadet European Cup 2024

Slovakia, Samorin, 23-24 Mar 2024

-50 kg

Men (33)

POOL A

	GALENKOV Ivo	BUL	1
	MIHALCA David Daniel	ROU	2
	MARDAN Nurdaulet	KAZ	3
	MARTZIANO Eyal	ISR	4
	PARIPOVIC Andrija	CRO	5
	JAKL Marek	CZE	6
	NEMSCHITZ Guy	ISR	7
	KOSTRYKIN Rostyslav	UKR	8

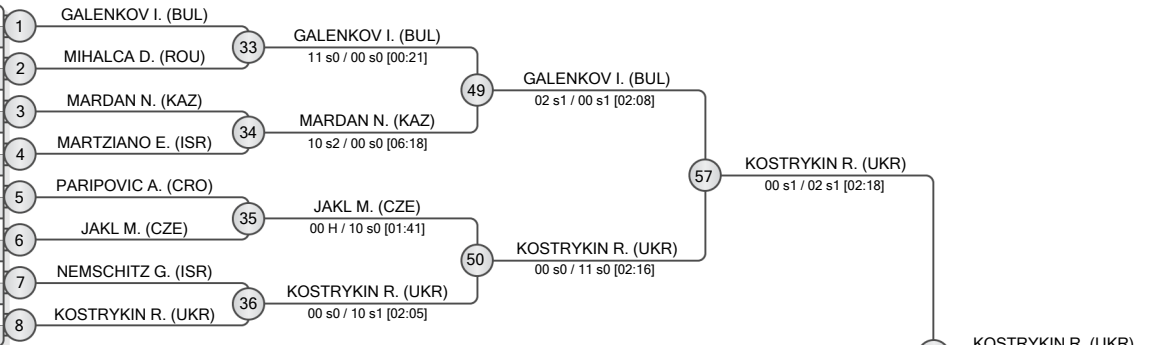

POOL B

	ALEKSIEJUNAS Natas	LTU	9
	BOLKVAÐZE Saba	GEO	10
	HRISTOV Emo	BUL	11
	ZHOLDASBEK Magzhan	KAZ	12
	ELDAN Michael	ISR	13
	OHRENSTEIN Yehonatan	ISR	14
	RUSEV Petar	BUL	15
	KOTZIAS Kyprianos	CYP	16
	BILKA Oliver	SVK	17

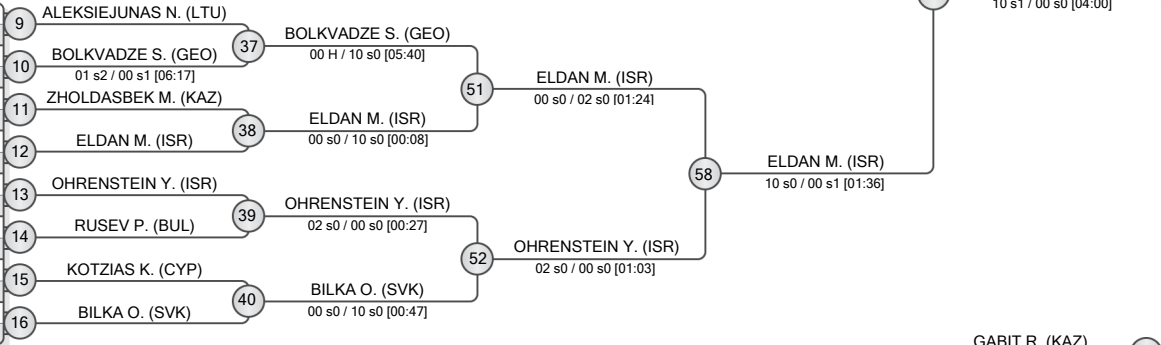

POOL C

	AHIEIEV Arsenii	UKR	17
	ROLNIK Gali	ISR	18
	FELLOUKA Loizos	CYP	19
	TODOROV Zlatomir	BUL	20
	ATANASOV Atanas	BUL	21
	KAKHIDZE Mirian	GEO	22
	SIMON Yonatan	ISR	23
	GABIT Rassulkhan	KAZ	24

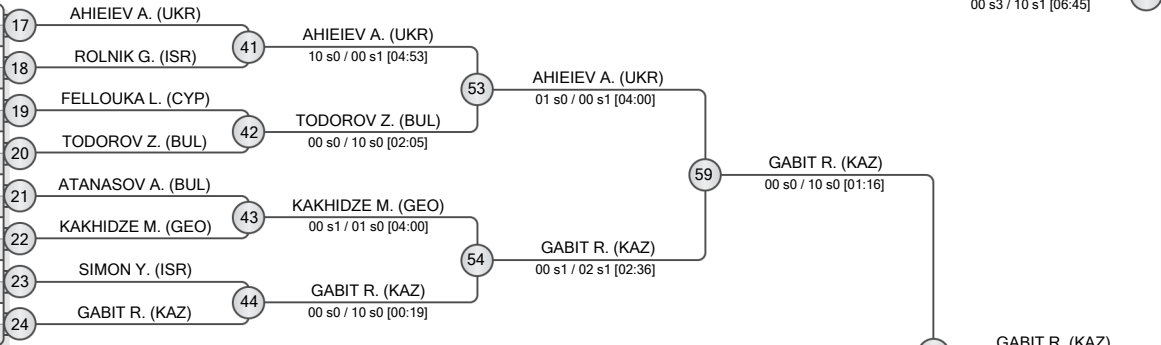

POOL D

	RADOVICS Mihály	HUN	25
	YELEMES Arsen	KAZ	26
	CIMBOLAS Timas	LTU	27
	STOYANOV Mihail	BUL	28
	BATALIN Nikita	UKR	29
	SIMON Tege	ROU	30
	HRAPKO Adam	SVK	31
	GOLDMAN Gilad	ISR	32

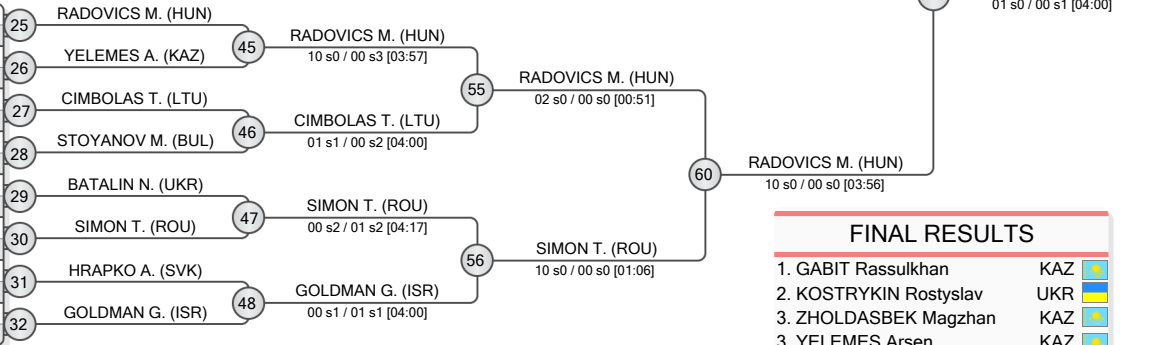

FINAL RESULTS		
1.	GABIT Rassulkhan	KAZ
2.	KOSTRYKIN Rostyslav	UKR
3.	ZHOLDASBEK Magzhan	KAZ
3.	YELEMES Arsen	KAZ
5.	RADOVICS Mihály	HUN
5.	ELDAN Michael	ISR
7.	GALENKOV Ivo	BUL
7.	AHIEIEV Arsenii	UKR

REPECHAGE

NEMSCHITZ G. (ISR)	61	NEMSCHITZ G. (ISR)	65	JAKL M. (CZE)	69
ZHOLDASBEK M. (KAZ)	62	BOLKVAÐZE S. (GEO)	66	ZHOLDASBEK M. (KAZ)	70
SIMON Y. (ISR)	63	SIMON Y. (ISR)	67	KAKHIDZE M. (GEO)	71
YELEMES A. (KAZ)	64	YELEMES A. (KAZ)	68	YELEMES A. (KAZ)	72

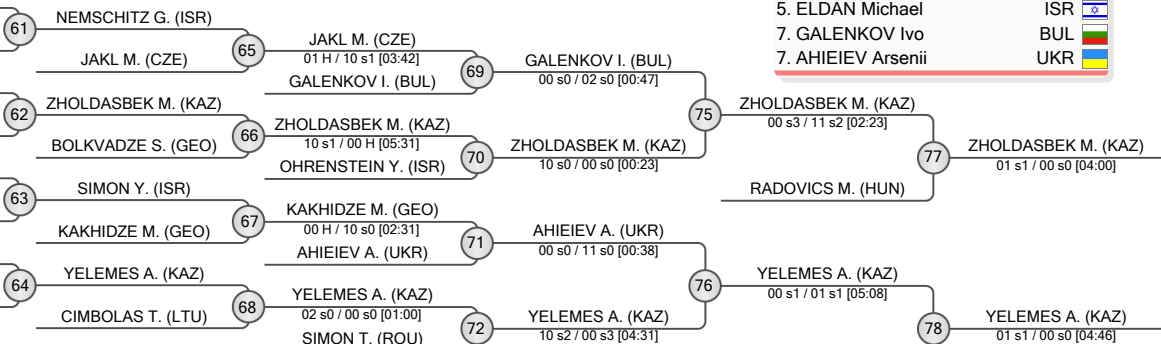



Samorin Cadet European Cup 2024

Slovakia, Samorin, 23-24 Mar 2024

-55 kg

Men (49)

POOL A

KUNYIK Botond	HUN	1	KUNYIK B. (HUN)	33	KUNYIK B. (HUN)	01 s1 / 00 s1 [04:00]	
ALMABEK Abylay	KAZ	2	AMICHAH Y. (ISR)	00 s0 / 11 s1 [01:28]	49	KUNYIK B. (HUN)	11 s1 / 00 s3 [03:38]
AMICHAH Yoav	ISR	3	SHULMAN S. (ISR)	00 s1 / 02 s0 [01:39]	34	MILOSEVIC A. (SRB)	00 s2 / 01 s2 [04:00]
ODZHAK Deniz	BUL	4	MILOSEVIC A. (SRB)	00 s2 / 01 s2 [04:00]	57	KUNYIK B. (HUN)	02 s0 / 00 s0 [03:51]
SHULMAN Shiloh	ISR	5	DARISPANASHVILI L. (GEO)		50	DARISPANASHVILI L. (GEO)	11 s0 / 00 s0 [01:07]
MILOSEVIC Aleksa	SRB	6	CHUHNENKO R. (ISR)	01 s1 / 00 s2 [04:21]	35	DARISPANASHVILI L. (GEO)	02 s0 / 00 s1 [03:54]
DARISPANASHVILI Luka	GEO	7	GALIA Jan	01 s1 / 00 s2 [04:21]	36	KOLOCZEK J. (POL)	00 s0 / 02 s1 [03:09]
CHUHNENKO Roma	ISR	8	BUTUCI K. (CRO)	00 s2 / 02 s0 [02:58]			
GALIA Jan	CZE		KOLOCZEK J. (POL)	00 s0 / 02 s1 [03:09]			
BRISUDA Filip	SVK						
BUTUCI Kristian	CRO						
KOLOCZEK Jakub	POL						

POOL B

MUNIZ ACOSTA Jakub	POL	9	MUNIZ ACOSTA J. (POL)	37	MUNIZ ACOSTA J. (POL)	10 s1 / 00 s3 [07:37]	
PILAUARI Saba	GEO	10	NACACHE I. (ISR)	00 s0 / 11 s0 [01:07]	51	MUNIZ ACOSTA J. (POL)	10 s1 / 00 s0 [01:48]
NACACHE Ishay	ISR	11	SELAY R. (ISR)	00 s0 / 11 s0 [00:35]	38	SELAY R. (ISR)	02 s0 / 00 s0 [00:41]
PANCNER Marek	CZE	12	SOFOKLEOUS S. (CYP)		39	HEYDAROV K. (UKR)	00 s0 / 10 s0 [00:30]
SELAY Roy	ISR	13	SORICI A. (ROU)		40	YELUBAYEV Y. (KAZ)	10 s0 / 00 s0 [01:33]
SOFOKLEOUS Sofoklis	CYP	14	HEYDAROV K. (UKR)	00 s3 / 10 s2 [05:00]	52	HEYDAROV K. (UKR)	02 s1 / 01 s1 [05:47]
SORICI Alin Marian	ROU	15	YELUBAYEV Y. (KAZ)	00 s0 / 01 s0 [04:18]	40	YELUBAYEV Y. (KAZ)	10 s0 / 00 s0 [01:33]
JAKUBAUSKAS Adris	LTU	16	MILJIC S. (SRB)	02 s0 / 00 s0 [02:21]			
HEYDAROV Khazar	UKR						
COHEN Elon	ISR						
YELUBAYEV Yeran	KAZ						
MILJIC Srdjan	SRB						
PAIS Maros	SVK						

POOL C

KOLONDRÁ Jan	POL	17	KOLONDRÁ J. (POL)	41	KOLONDRÁ J. (POL)	01 s1 / 00 s2 [04:00]	
SHAASHOUA Chanoch Eliezer	ISR	18	SHAASHOUA C. (ISR)	10 s1 / 00 s1 [03:49]	53	BATYRGALI Y. (KAZ)	00 s2 / 01 s0 [07:45]
TAMAS Gabor	ROU	19	BATYRGALI Y. (KAZ)	02 s0 / 00 s1 [01:07]	42	BATYRGALI Y. (KAZ)	01 s1 / 00 s2 [05:08]
BATYRGALI Yernur	KAZ	20	LEVIN O. (ISR)		43	VALJENT M. (CZE)	00 s0 / 02 s0 [01:16]
BOSKOVIC Teo	CRO	21	ZINCHUK M. (UKR)		54	VALJENT M. (CZE)	01 s1 / 00 s0 [04:00]
LEVIN Or	ISR	22	VALJENT M. (CZE)	10 s0 / 00 s0 [00:34]	44	KANJARASHVILI L. (GEO)	10 s0 / 00 s0 [00:06]
ZINCHUK Maksym	UKR	23	KANJARASHVILI L. (GEO)	11 s1 / 00 s3 [02:34]	44	KANJARASHVILI L. (GEO)	10 s0 / 00 s0 [00:06]
VALJENT Matyas	CZE	24	SZABO D. (SVK)				
HADJIYIANNIS Nestoras	CYP						
KANJARASHVILI Luka	GEO						
GREENBERG Omer	ISR						
SZABO Daniel	SVK						

POOL D

MAKULAVICIUS Rokas	LTU	25	MAKULAVICIUS R. (LTU)	45	ROSENTHAL N. (ISR)	00 s1 / 10 s0 [02:18]	
SPICKA Matej	CZE	26	ROSENTHAL N. (ISR)	01 s1 / 02 s1 [04:52]	55	ROSENTHAL N. (ISR)	02 s0 / 00 s0 [02:34]
ROSENTHAL Noam	ISR	27	WEINBERGER O. (ISR)		46	SMILJKOVIC F. (SRB)	00 s0 / 10 s0 [00:48]
LACIKA Silvio	SVK	28	SMILJKOVIC F. (SRB)		47	TZEMAH Y. (ISR)	00 s0 / 01 s1 [04:00]
WEINBERGER Omri	ISR	29	SUTEJ L. (CRO)		56	DOSBERGEN N. (KAZ)	00 s1 / 01 s2 [04:00]
SMILJKOVIC Filip	SRB	30	TZEMAH Y. (ISR)	00 s0 / 01 s0 [04:30]	48	DOSBERGEN N. (KAZ)	01 s0 / 00 s1 [04:41]
SUTEJ Leon	CRO	31	DOSBERGEN N. (KAZ)	00 s0 / 02 s0 [01:52]			
STEFANEK Hunor	HUN	32	TURILOV O. (UKR)				
TZEMAH Yali	ISR						
STEFANOV Samuil	BUL						
DOSBERGEN Nurdos	KAZ						
TURILOV Oleksandr	UKR						

REPECHAGE

AMICHAH Y. (ISR)	61	AMICHAH Y. (ISR)	65	MILOSEVIC A. (SRB)	00 s1 / 10 s1 [02:18]	69	DARISPANASHVILI L. (GEO)	00 s2 / 10 s0 [02:44]	75	DARISPANASHVILI L. (GEO)	02 s0 / 00 s1 [00:33]	77	DOSBERGEN N. (KAZ)	01 H / 10 s1 [02:38]
JAKUBAUSKAS A. (LTU)		MILOSEVIC A. (SRB)		DARISPANASHVILI L. (GEO)										
SORICI A. (ROU)	62	SORICI A. (ROU)	66	SORICI A. (ROU)	01 s1 / 00 s0 [06:28]	70	SORICI A. (ROU)	10 s2 / 00 s3 [05:28]						
BOSKOVIC T. (CRO)		YELUBAYEV Y. (KAZ)		MUNIZ ACOSTA J. (POL)										
LEVIN O. (ISR)	63	LEVIN O. (ISR)	67	KOLONDRÁ J. (POL)	00 H / 10 s0 [01:01]	71	KOLONDRÁ J. (POL)	02 s0 / 00 s0 [00:39]						
STEFANOV S. (BUL)		KOLONDRÁ J. (POL)		VALJENT M. (CZE)										
TURILOV O. (UKR)	64	TURILOV O. (UKR)	68	TZEMAH Y. (ISR)	01 s0 / 02 s0 [03:52]	72	ROSENTHAL N. (ISR)	00 s3 / 10 s0 [10:16]	76	KOLONDRÁ J. (POL)	10 s1 / 00 s3 [06:28]	78	KOLONDRÁ J. (POL)	10 s2 / 00 H [09:06]
		TZEMAH Y. (ISR)		ROSENTHAL N. (ISR)										

FINAL RESULTS		
1. BATYRGALI Yernur	KAZ	
2. KUNYIK Botond	HUN	
3. DOSBERGEN Nurdos	KAZ	
4. KOLONDRÁ Jan	POL	
5. DARISPANASHVILI Luka	GEO	
5. HEYDAROV Khazar	UKR	
7. SORICI Alin Marian	ROU	
7. ROSENTHAL Noam	ISR	





Samorin Cadet European Cup 2024

Slovakia, Samorin, 23-24 Mar 2024

-60 kg

Men (55)

POOL A

	KUROWSKI Jakub	POL	1	KUROWSKI J. (POL)					
	NOAM Nitai	ISR	2	NOAM N. (ISR)	33	KUROWSKI J. (POL)	10 s0 / 00 s0 [00:48]		
	TRETYNNYK Maksym	UKR	3	MAOR Ron	34	KABDESHOV B. (KAZ)	00 s1 / 01 s0 [04:00]	49	KUROWSKI J. (POL)
	MAOR Ron	ISR	3	MAOR R. (ISR)					01 s2 / 00 s2 [10:05]
	TOMAS Michal	SVK	4	KABDESHOV B. (KAZ)					
	CHLADEK David	CZE	4	KABDESHOV B. (KAZ)					
	KABDESHOV Bakdaulet	KAZ	4	KABDESHOV B. (KAZ)					
	MACEJKA Marek	SVK	5	MACEJKA M. (SVK)					
	ZAPOROZHETS Ivan	UKR	6	TCHIABERASHVILI V. (GEO)	35	TCHIABERASHVILI V. (GEO)	00 s3 / 10 s0 [06:00]	50	TCHIABERASHVILI V. (GEO)
	TCHIABERASHVILI Vakhtangi	GEO	6	TCHIABERASHVILI V. (GEO)					02 s0 / 00 s0 [03:02]
	BENISEK Filip	SRB	7	ASNASH O. (ISR)	36	HERTA D. (MDA)	00 s0 / 10 s0 [00:26]		
	ASNASH Ofek	ISR	7	ASNASH O. (ISR)					
	MOLNAR Zsombor	HUN	8	HERTA D. (MDA)					
	HERTA David	MDA	8	HERTA D. (MDA)					

POOL B

	GALO Bence	HUN	9	GALO B. (HUN)	37	GALO B. (HUN)	10 s0 / 00 s1 [01:50]	51	GALO B. (HUN)
	TCACI Stanislav	CZE	10	TCACI S. (CZE)					10 s2 / 00 s1 [02:25]
	NIKOLOV Preslav	BUL	10	NIKOLOV P. (BUL)					
	PAL Norbert	ROU	11	PAL N. (ROU)	38	OLIINYK I. (UKR)	00 s0 / 10 s0 [00:18]	58	COHEN S. (ISR)
	POPIER Jan	SVK	11	POPIER J. (SVK)					00 s0 / 02 s0 [01:59]
	GILAD Itay	ISR	12	OLIINYK I. (UKR)					
	OLIINYK Illia	UKR	12	OLIINYK I. (UKR)					
	COHEN Shalev	ISR	13	COHEN S. (ISR)	39	COHEN S. (ISR)	02 s0 / 01 s1 [03:00]	52	COHEN S. (ISR)
	SUKHORUKOV Semyon	KAZ	14	SUKHORUKOV S. (KAZ)					10 s0 / 00 s1 [01:04]
	ROSA Lukasz	POL	14	ROSA L. (POL)					
	NEMASIK Matej	SVK	15	BASOV R. (UKR)	40	BORCHASHVILI C. (GEO)	00 s0 / 11 s0 [02:37]		
	BASOV Renat	UKR	15	BASOV R. (UKR)					
	BADASH Yair	ISR	16	BORCHASHVILI C. (GEO)					
	BORCHASHVILI Chinig	GEO	16	BORCHASHVILI C. (GEO)					

POOL C

	KEKVIASHVILI Gigi	GEO	17	KEKVIASHVILI G. (GEO)	41	KEKVIASHVILI G. (GEO)	10 s0 / 00 s0 [01:03]	53	KEKVIASHVILI G. (GEO)
	OVERCHENKO Maksim	ISR	18	OVERCHENKO M. (ISR)					02 s0 / 00 s0 [01:27]
	AILOAE Iaroslav	MDA	18	AILOAE I. (MDA)					
	KONYSBAY Altynbek	KAZ	19	KONYSBAY A. (KAZ)	42	KONYSBAY A. (KAZ)	02 s0 / 00 s2 [02:14]	59	KEKVIASHVILI G. (GEO)
	SEMEVOYCH Orest	UKR	19	SEMEVOYCH O. (UKR)					02 s0 / 01 s2 [03:22]
	KAPLAN Yonatan	ISR	20	KAPLAN Y. (ISR)					
	FRIDMAN Maor	ISR	21	FRIDMAN M. (ISR)	43	FRIDMAN M. (ISR)	10 s0 / 00 s0 [00:30]	54	FRIDMAN M. (ISR)
	SZEGNER Daniel	HUN	22	DIMITROV K. (BUL)					10 s1 / 01 H [01:49]
	DIMITROV Kristiyan	BUL	22	DIMITROV K. (BUL)					
	SWITALA Pawel	POL	23	NANETASHVILI N. (GEO)	44	NANETASHVILI N. (GEO)	11 s1 / 00 s0 [03:54]		
	NANETASHVILI Nika	GEO	23	NANETASHVILI N. (GEO)					
	SCECINA Alfred	SVK	24	IONITA D. (ROU)					
	IONITA David	ROU	24	IONITA D. (ROU)					

POOL D

	OROZMAMATOV Adis	KGZ	25	OROZMAMATOV A. (KGZ)	45	OROZMAMATOV A. (KGZ)	01 s0 / 00 s1 [04:00]	55	OROZMAMATOV A. (KGZ)
	DIMITROV Samuil	BUL	26	DIMITROV S. (BUL)					01 s0 / 00 s1 [04:00]
	AMALL Adar	ISR	26	AMALL A. (ISR)					
	SOFER Rotem	ISR	27	SOFER R. (ISR)	46	SOFER R. (ISR)	02 s0 / 01 s0 [03:49]	60	OROZMAMATOV A. (KGZ)
	MALIKOV Semen	UKR	27	MALIKOV S. (UKR)					01 s1 / 00 s1 [04:34]
	HOMOLKA Josef	CZE	28	HOMOLKA J. (CZE)					
	KRAJCIR Alex	SVK	28	KRAJCIR A. (SVK)					
	KNEZ Filip	CRO	29	KNEZ F. (CRO)	47	KNEZ F. (CRO)	10 s0 / 00 s3 [02:52]	56	DASKAL I. (ISR)
	KLIUCHKOYCH Oleksandr	SVK	30	JOVANOVIC N. (SRB)					00 s2 / 02 s1 [03:35]
	JOVANOVIC Nikola	SRB	30	JOVANOVIC N. (SRB)					
	ZHARINOV Illia	UKR	31	DASKAL I. (ISR)	48	DASKAL I. (ISR)	01 s0 / 00 s2 [04:00]		
	DASKAL Itay	ISR	31	DASKAL I. (ISR)					
	SIKHARULIDZE Dato	GEO	32	BOLAT A. (KAZ)					
	BOLAT Assanali	KAZ	32	BOLAT A. (KAZ)					

REPECHAGE

	NOAM N. (ISR)	61	NOAM N. (ISR)	65	KABDESHOV B. (KAZ)	69	KABDESHOV B. (KAZ)	75	KABDESHOV B. (KAZ)	77	OROZMAMATOV A. (KGZ)
											00 s1 / 01 s1 [05:45]
	SUKHORUKOV S. (KAZ)	62	SUKHORUKOV S. (KAZ)	66	SUKHORUKOV S. (KAZ)	70	SUKHORUKOV S. (KAZ)				
	OVERCHENKO M. (ISR)	63	OVERCHENKO M. (ISR)	67	KONYSBAY A. (KAZ)	71	KONYSBAY A. (KAZ)				
	DIMITROV S. (BUL)	64	DIMITROV S. (BUL)	68	SOFER R. (ISR)	72	DASKAL I. (ISR)	76	DASKAL I. (ISR)	78	KUROWSKI J. (POL)
											00 s1 / 10 s1 [02:10]

FINAL RESULTS

- COHEN Shalev
- KEKVIASHVILI Gigi
- OROZMAMATOV Adis
- KUROWSKI Jakub
- KABDESHOV Bakdaulet
- DASKAL Itay
- SUKHORUKOV Semyon
- KONYSBAY Altynbek





Samorin Cadet European Cup 2024

Slovakia, Samorin, 23-24 Mar 2024

-66 kg

Men (56)

POOL A

SEGA David	CRO
ZAVOS Aris	CYP
GUSHKOV Stilyan	BUL
VOSTREL Vit	CZE
SIMSALEK Ivan	SVK
MAYER Gilad	ISR
GONDOR Kristof	HUN
ROZGA Roko	CRO
SHUKVANI Valer	GEO
OSTAPENKO Bohdan	UKR
MURESAN Marius	ROU
VAGULIS Danas	LTU
FERENC Wojciech	POL
TODOROV Nikolay	BUL

1	SEGA D. (CRO)	33	GUSHKOV S. (BUL)
2	GUSHKOV S. (BUL)	00 s0 / 10 s1 [03:48]	00 s3 / 10 s2 [06:16]
3	VOSTREL V. (CZE)	11 s0 / 00 s0 [01:19]	01 s1 / 00 s2 [04:20]
4	MAYER G. (ISR)	10 s0 / 00 s0 [01:05]	
5	ROZGA R. (CRO)		
6	OSTAPENKO B. (UKR)	00 s1 / 02 s0 [01:49]	00 s2 / 10 s1 [01:48]
7	VAGULIS D. (LTU)	00 s1 / 02 s1 [04:25]	00 H / 10 s0 [00:58]
8	FERENC W. (POL)	10 s0 / 00 s0 [02:18]	

49	VOSTREL V. (CZE)	00 s1 / 10 s1 [01:39]	57	OSTAPENKO B. (UKR)	00 s3 / 11 s0 [03:06]
34	VOSTREL V. (CZE)	01 s1 / 00 s2 [04:20]	50	OSTAPENKO B. (UKR)	02 s0 / 00 s0 [01:29]
35	OSTAPENKO B. (UKR)	00 s2 / 10 s1 [01:48]	36	FERENC W. (POL)	00 H / 10 s0 [00:58]
37	KURDGELASHVILI N. (GEO)	01 s1 / 02 s0 [03:30]	38	GRUBELSKI J. (POL)	00 s0 / 02 s1 [02:38]
39	MARTYNCHUK O. (UKR)	00 s1 / 11 s0 [01:43]	40	GEORGIU K. (CYP)	00 s1 / 10 s0 [01:18]

POOL B

TOMIC Stiv	CRO
NIKOLOV Milen	BUL
KURDGELASHVILI Nikoloz	GEO
KONYSBAY Akniyet	KAZ
KORDOS Kristof	SVK
MANOJLOVIC Dusan	SRB
GRUBELSKI Jakub	POL
KARALEVICIUS Zygimantas	LTU
SAMUKASHVILI Davit	GEO
MARTYNCHUK Oleksandr	UKR
RUSNAK Adam	CZE
VECEREK Roman	SVK
GEORGIU Konstantinos	CYP
DVOSIS Ofri	ISR

9	TOMIC S. (CRO)	37	KURDGELASHVILI N. (GEO)
10	KURDGELASHVILI N. (GEO)	00 s1 / 10 s0 [04:34]	01 s1 / 02 s0 [03:30]
11	KONYSBAY A. (KAZ)	10 s0 / 00 s0 [00:15]	00 s0 / 02 s1 [02:38]
12	GRUBELSKI J. (POL)	01 s3 / 11 s1 [04:32]	
13	KARALEVICIUS Z. (LTU)		
14	MARTYNCHUK O. (UKR)	00 s1 / 02 s1 [02:05]	00 s1 / 11 s0 [01:43]
15	RUSNAK A. (CZE)	11 s0 / 00 s0 [02:42]	10 s2 / 00 s1 [01:57]
16	GEORGIU K. (CYP)	10 s1 / 00 s1 [03:49]	

51	KURDGELASHVILI N. (GEO)	10 s2 / 00 s1 [03:51]	58	MARTYNCHUK O. (UKR)	00 s1 / 11 s1 [02:22]
38	GRUBELSKI J. (POL)	00 s0 / 02 s1 [02:38]	39	MARTYNCHUK O. (UKR)	00 s1 / 11 s0 [01:43]
40	GEORGIU K. (CYP)	00 s1 / 10 s0 [01:18]	41	ODKLADAL J. (SVK)	02 s1 / 00 s1 [02:31]
42	LEVIN S. (ISR)	01 H / 10 s0 [01:48]	43	ADERET N. (ISR)	10 s2 / 00 s3 [04:58]
43	ADERET N. (ISR)	10 s2 / 00 s3 [04:58]	44	PAVLOV P. (BUL)	00 s0 / 10 s0 [00:52]

POOL C

ODKLADAL Juraj	SVK
ZAUTASHVILI Luka	GEO
HADZI-VELJKOVIC Nikola	CRO
JAKOBCZYK Antoni	POL
ABAY Islam	KAZ
KLIMSJA Jan	CZE
LEVIN Shahaf	ISR
RADUCANU Ionut	ROU
ADERET Noam	ISR
UBILAVA Mikheil	GEO
POPIER Adam	SVK
RADOJCIC Stefan	SRB
PAVLOV Petar	BUL
NARKUS Girvydas	LTU

17	ODKLADAL J. (SVK)	41	ODKLADAL J. (SVK)	02 s1 / 00 s1 [02:31]	
18	HADZI-VELJKOVIC N. (CRO)	00 s3 / 10 s1 [02:30]	42	LEVIN S. (ISR)	01 H / 10 s0 [01:48]
19	ABAY I. (KAZ)	01 s0 / 10 s0 [01:43]	43	ADERET N. (ISR)	10 s2 / 00 s3 [04:58]
20	LEVIN S. (ISR)	00 s0 / 10 s0 [01:00]	44	PAVLOV P. (BUL)	00 s0 / 10 s0 [00:52]
21	RADUCANU I. (ROU)		45	SPANOS G. (GRE)	01 s1 / 10 s2 [01:53]

53	ODKLADAL J. (SVK)	10 s0 / 00 s0 [00:39]	59	ODKLADAL J. (SVK)	10 s1 / 00 s2 [02:29]
42	LEVIN S. (ISR)	01 H / 10 s0 [01:48]	54	RADUCANU I. (ROU)	02 s1 / 00 s0 [03:20]
43	ADERET N. (ISR)	10 s2 / 00 s3 [04:58]	44	PAVLOV P. (BUL)	00 s0 / 10 s0 [00:52]
45	SPANOS G. (GRE)	01 s1 / 10 s2 [01:53]	46	BRISUDA S. (SVK)	01 s1 / 02 s0 [02:50]
46	BRISUDA S. (SVK)	01 s1 / 02 s0 [02:50]	47	RESUTIK A. (CZE)	10 s0 / 00 s1 [02:45]

POOL D

NAZARENKO Illia	UKR
MIKONIS Dangiras	LTU
SPANOS Georgios	GRE
RAFAEL Abraham	HUN
HADJISAVVAS Georgios	CYP
CEREDNICENKO Artur	CZE
BRISUDA Samuel	SVK
RESUTIK Adam	CZE
FRIEDRICH Noam	ISR
LAZAR Milan	SVK
MARGIANI Giorgi	GEO
SANDLERMAN Artur	POL
BABACHEV Stilyan	BUL
PREDA Emanuel	ROU

25	NAZARENKO I. (UKR)	45	NAZARENKO I. (UKR)	10 s0 / 00 s1 [03:01]	
26	SPANOS G. (GRE)	01 s1 / 10 s2 [01:53]	46	BRISUDA S. (SVK)	01 s1 / 02 s0 [02:50]
27	HADJISAVVAS G. (CYP)	00 s0 / 10 s0 [00:16]	47	RESUTIK A. (CZE)	10 s0 / 00 s1 [02:45]
28	BRISUDA S. (SVK)	00 s2 / 10 s0 [03:41]	48	BABACHEV S. (BUL)	01 s3 / 10 s2 [04:00]
29	RESUTIK A. (CZE)		49	VOSTREL V. (CZE)	00 H / 10 s0 [02:19]

55	NAZARENKO I. (UKR)	02 s0 / 00 s1 [02:03]	60	NAZARENKO I. (UKR)	02 s0 / 00 s1 [01:50]
46	BRISUDA S. (SVK)	01 s1 / 02 s0 [02:50]	56	BABACHEV S. (BUL)	00 H / 10 s0 [02:28]
47	RESUTIK A. (CZE)	10 s0 / 00 s1 [02:45]	61	ROZGA R. (CRO)	00 s1 / 01 s1 [05:37]
48	BABACHEV S. (BUL)	01 s3 / 10 s2 [04:00]	65	FERENC W. (POL)	00 s1 / 10 s2 [01:45]
49	VOSTREL V. (CZE)	00 H / 10 s0 [02:19]	66	SAMUKASHVILI D. (GEO)	01 s0 / 00 s0 [04:00]

REPECHAGE

61	ROZGA R. (CRO)	00 s1 / 01 s1 [05:37]	65	FERENC W. (POL)	00 s1 / 10 s2 [01:45]
62	SAMUKASHVILI D. (GEO)	10 s0 / 00 s3 [02:28]	66	SAMUKASHVILI D. (GEO)	01 s0 / 00 s0 [04:00]
63	HADZI-VELJKOVIC N. (CRO)		67	LEVIN S. (ISR)	00 s0 / 11 s1 [01:09]
64	SPANOS G. (GRE)		68	BRISUDA S. (SVK)	10 s0 / 00 s0 [01:41]

65	FERENC W. (POL)	00 s1 / 10 s2 [01:45]	69	VOSTREL V. (CZE)	00 H / 10 s0 [02:19]
66	SAMUKASHVILI D. (GEO)	01 s0 / 00 s0 [04:00]	70	SAMUKASHVILI D. (GEO)	02 s2 / 00 s2 [02:11]
67	LEVIN S. (ISR)	00 s0 / 11 s1 [01:09]	71	LEVIN S. (ISR)	02 s0 / 00 s0 [01:09]
68	BRISUDA S. (SVK)	10 s0 / 00 s0 [01:41]	72	SPANOS G. (GRE)	02 s0 / 00 s0 [02:28]

69	VOSTREL V. (CZE)	00 H / 10 s0 [02:19]	75	SAMUKASHVILI D. (GEO)	00 s0 / 02 s0 [02:11]
70	SAMUKASHVILI D. (GEO)	02 s2 / 00 s2 [02:11]	76	LEVIN S. (ISR)	10 s1 / 00 s1 [00:55]
71	LEVIN S. (ISR)	02 s0 / 00 s0 [01:09]	77	NAZARENKO I. (UKR)	00 s0 / 02 s0 [01:04]
72	SPANOS G. (GRE)	02 s0 / 00 s0 [02:28]	78	OSTAPENKO B. (UKR)	00 s2 / 02 s1 [03:34]

FINAL RESULTS

- MARTYNCHUK Oleksandr
- ODKLADAL Juraj
- NAZARENKO Illia
- OSTAPENKO Bohdan
- SAMUKASHVILI Davit
- LEVIN Shahaf
- VOSTREL Vit
- SPANOS Georgios





Samorin Cadet European Cup 2024

Slovakia, Samorin, 23-24 Mar 2024

-73 kg

Men (65)

POOL A

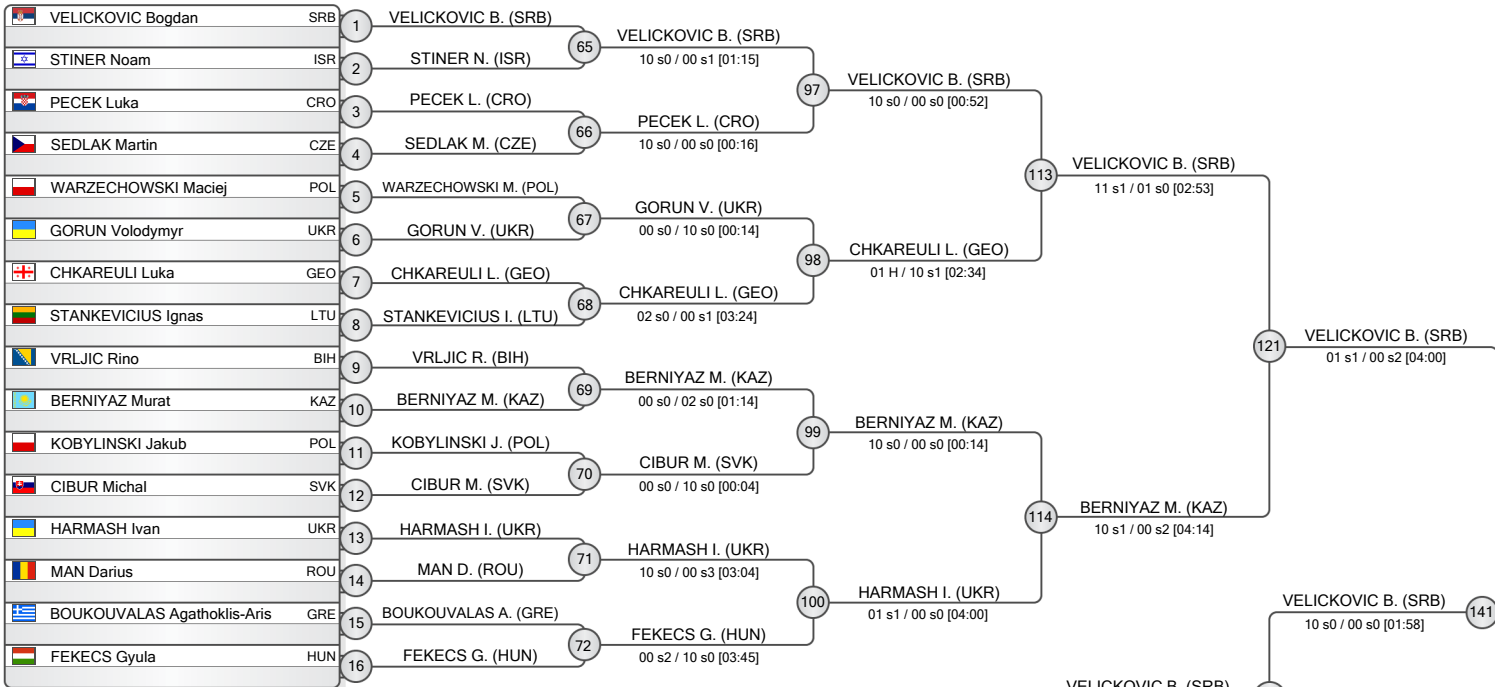

POOL B

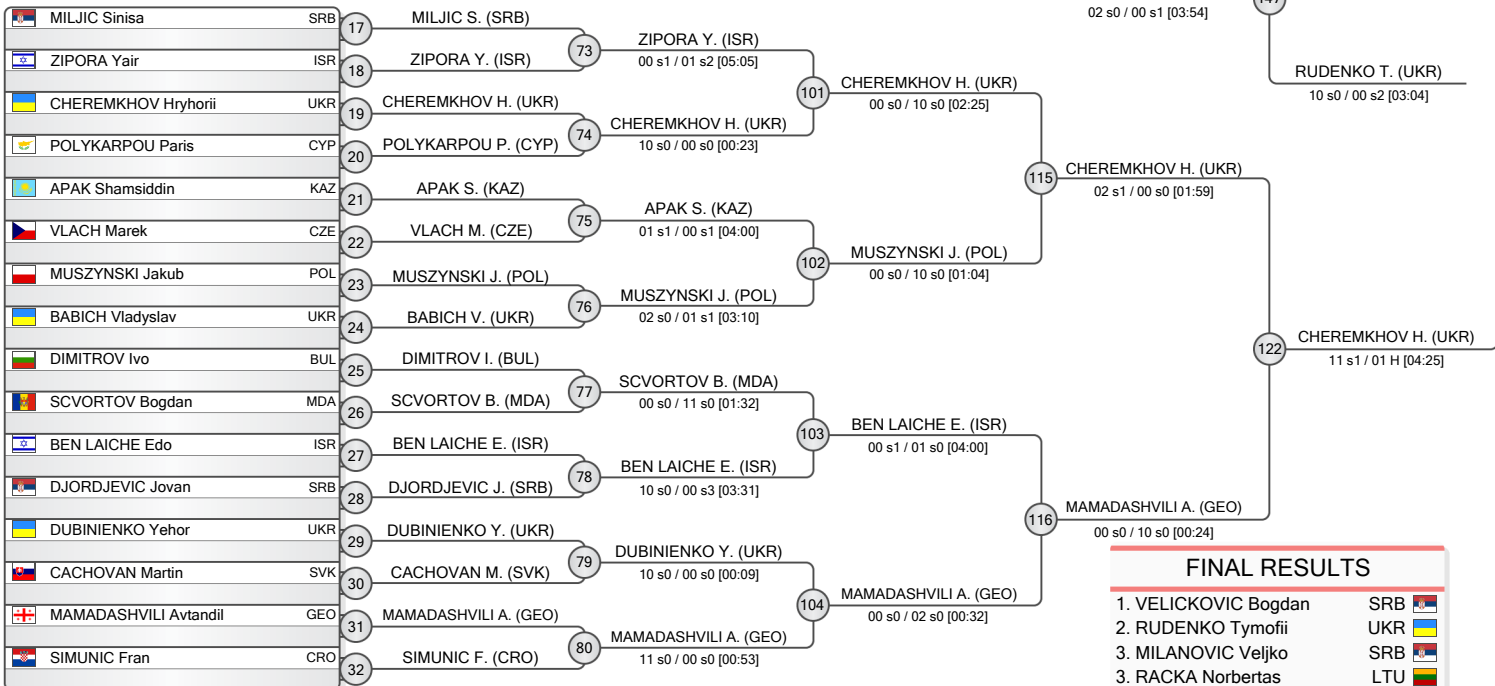

FINAL RESULTS		
1.	VELICKOVIC Bogdan	SRB
2.	RUDENKO Tymofii	UKR
3.	MILANOVIC Veljko	SRB
3.	RACKA Norbertas	LTU
5.	BERNIYAZ Murat	KAZ
5.	CHEREMKHOV Hryhorii	UKR
7.	MUSZYNSKI Jakub	POL
7.	BAINVOLL Tomer	ISR

REPECHAGE

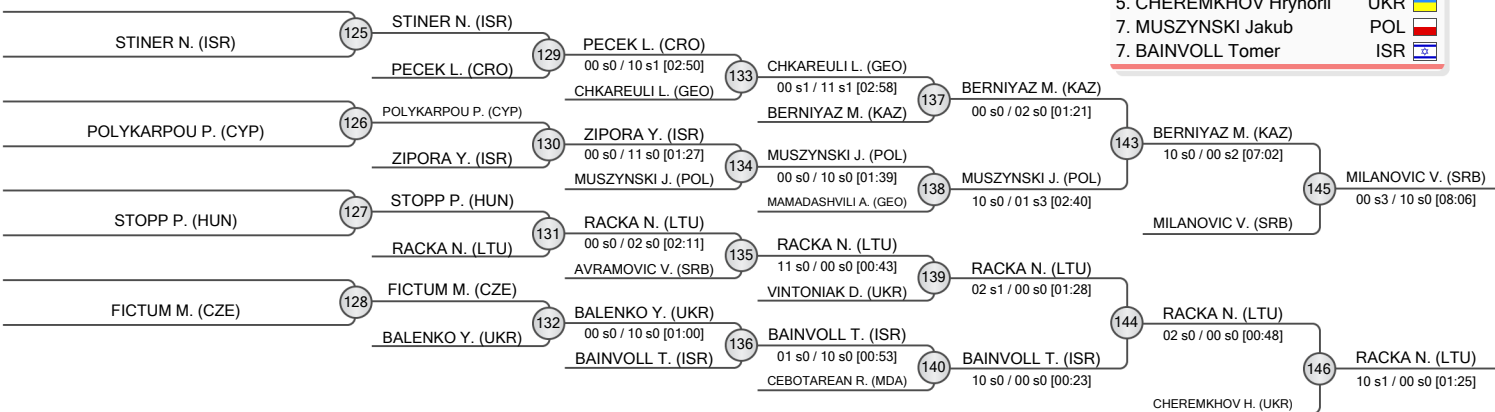



Samorin Cadet European Cup 2024

Slovakia, Samorin, 23-24 Mar 2024

-73 kg

Men (65)

POOL C

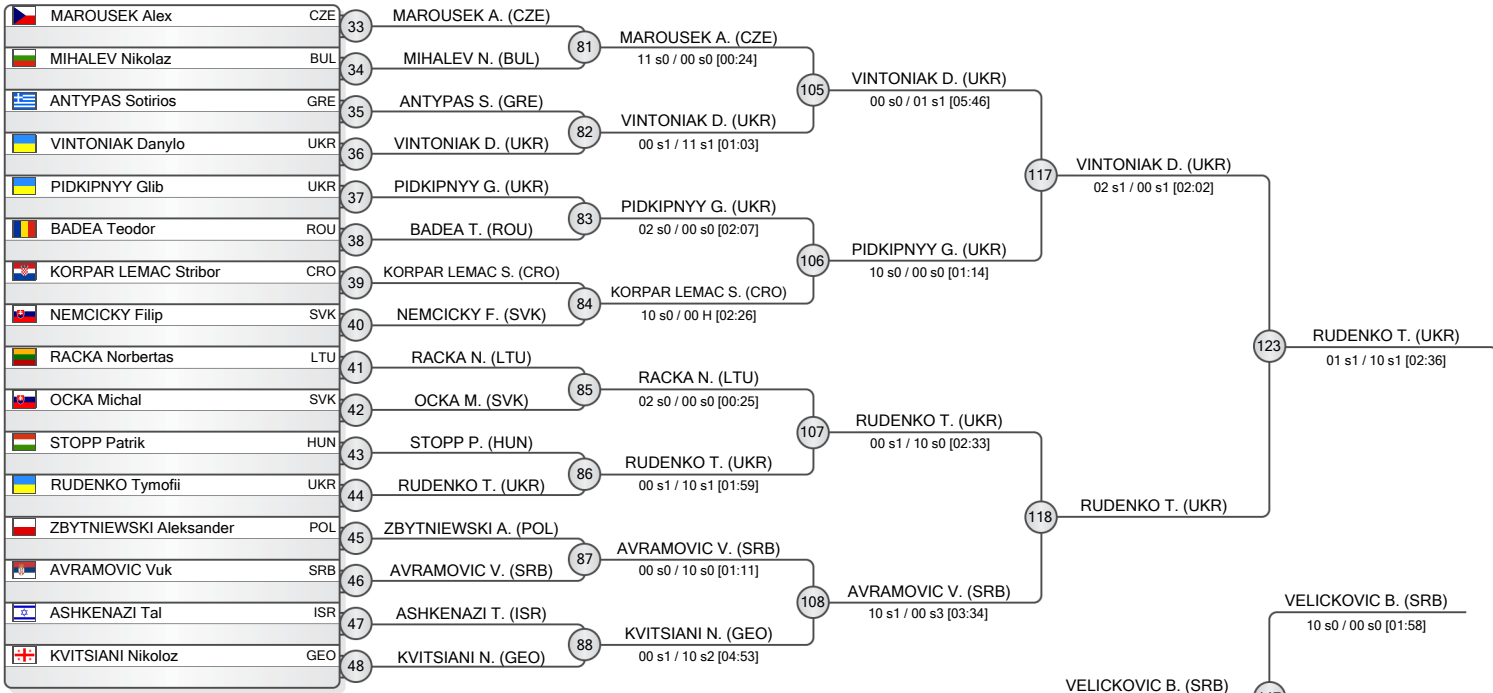

POOL D

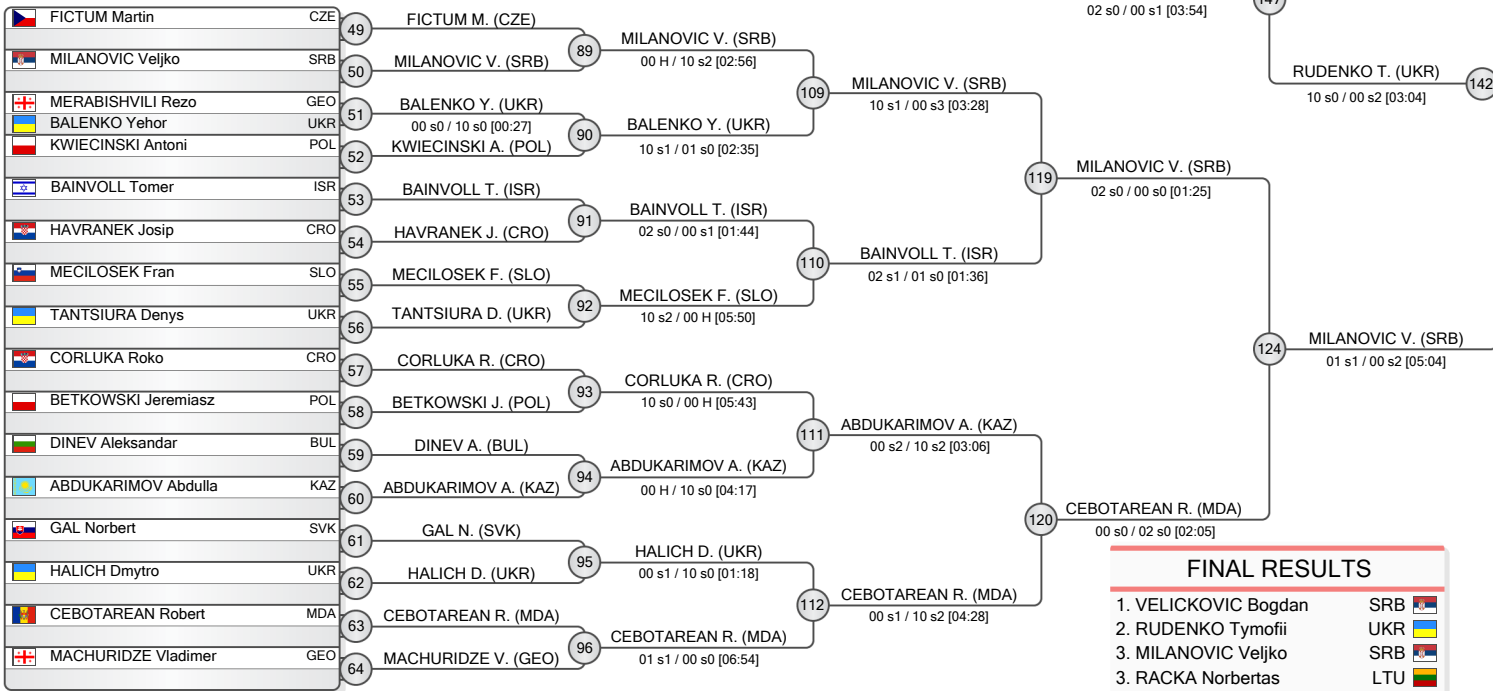

FINAL RESULTS		
1.	VELICKOVIC Bogdan	SRB
2.	RUDENKO Tymofii	UKR
3.	MILANOVIC Veljko	SRB
3.	RACKA Norbertas	LTU
5.	BERNIYAZ Murat	KAZ
5.	CHEREMKHOV Hryhorii	UKR
7.	MUSZYNSKI Jakub	POL
7.	BAINVOLL Tomer	ISR

REPECHAGE

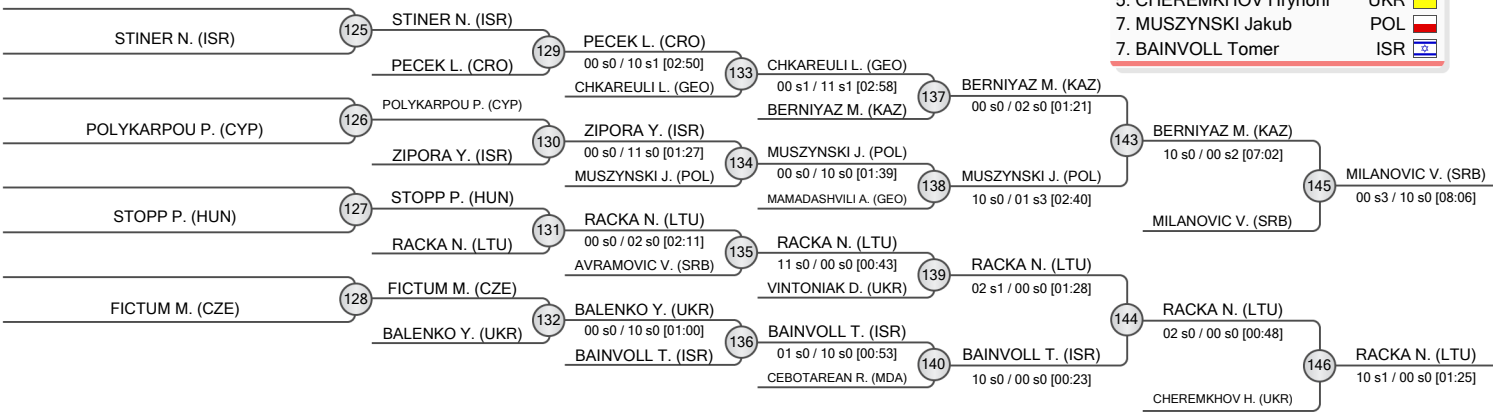



Samorin Cadet European Cup 2024

Slovakia, Samorin, 23-24 Mar 2024

-81 kg

Men (51)

POOL A

1	DJINKIC Ivano (BIH)	1	DJINKIC I. (BIH)
2	MOGILNI Kirill (ISR)	33	MOGILNI K. (ISR)
3	NEACSU Rares (ROU)	34	KASHIBADZE K. (GEO)
4	TZAGKIDIS Nikolaos (GRE)	34	KARAKIN S. (UKR)
5	KASHIBADZE Koba (GEO)	35	SOLIANYK M. (UKR)
6	PORSOK Peter (SVK)	35	SOLIANYK M. (UKR)
7	KARAKIN Serhii (UKR)	36	SIERAKOWSKI M. (POL)
8	SOLIANYK Mykhailo (UKR)	36	BAKTYBAY S. (KAZ)
			PRAUS V. (CZE)
			PRAUS V. (CZE)

POOL B

9	SARBOCH Vit (CZE)	9	SARBOCH V. (CZE)
10	IANCU Robert (ROU)	37	IANCU R. (ROU)
11	CHLEBIK Samuel (SVK)	38	AMIRIAN A. (UKR)
12	AMIRIAN Artur (UKR)	38	LIPARTELIANI D. (GEO)
13	LECHOWICZ Marek (POL)	39	JAKS A. (CZE)
14	LIPARTELIANI Dachi (GEO)	39	UTIASHVILI T. (GEO)
15	JAKS Adam (CZE)	40	KOVACS M. (HUN)
16	UTIASHVILI Tato (GEO)	40	SLOVIC M. (SRB)
17	KAVSIAN Samoel (BUL)		PAVLOVIC Fredi (CRO)
18	KOVACS Mark (HUN)		
19	SLYAMZHANOV Alisher (KAZ)		
20	SLOVIC Milos (SRB)		
21	PAVLOVIC Fredi (CRO)		

POOL C

17	MUKHUM Rassul (KAZ)	17	MUKHUM R. (KAZ)
18	MEDAN Nikola (SRB)	41	MEDAN N. (SRB)
19	KOSSUTH Oliver (SVK)	42	NATSVLISHVILI G. (GEO)
20	NATSVLISHVILI Giorgi (GEO)	42	DZIAVORUK I. (UKR)
21	CHARALAMPOUS Miltiadis (CYP)	43	DZIAVORUK I. (UKR)
22	DZIAVORUK Ivan (UKR)	43	ZIZAK N. (CRO)
23	ZIZAK Nikola (CRO)	44	KUCERA K. (CZE)
24	FOGEL Alon (ISR)	44	DURDEVIC A. (BIH)
25	KUCERA Kristian (CZE)		DUREJE J. (SVK)
26	DIMITROV Hristo (BUL)		
27	DURDEVIC Adrian (BIH)		
28	DUREJE Jakub (SVK)		

POOL D

25	MARCZAK Derek (POL)	25	MARCZAK D. (POL)
26	MARIUKHNYCH Vladyslav (UKR)	45	HAJNECKY M. (SVK)
27	HAJNECKY Marco (SVK)	46	BENIAIDZE G. (GEO)
28	BENIAIDZE Giorgi (GEO)	46	HALASZ A. (HUN)
29	NONCHEV Dimitar (BUL)	47	SWIDWA R. (POL)
30	HALASZ Aron (HUN)	47	PEREVERTAILO K. (UKR)
31	SWIDWA Robert (POL)	48	PEREVERTAILO K. (UKR)
32	JOVANOVIC Luka (SRB)	48	BABAICENKO T. (LTU)
33	PEREVERTAILO Kyrylo (UKR)		BEISEMBAY A. (KAZ)
34	BABAICENKO Tajus (LTU)		
35	KLIMES Vojtech (CZE)		
36	SZABO Bence (ROU)		
37	BEISEMBAY Alikhan (KAZ)		

REPECHAGE

61	SIERAKOWSKI M. (POL)	61	SIERAKOWSKI M. (POL)
62	UTIASHVILI T. (GEO)	65	PRAUS V. (CZE)
63	FOGEL A. (ISR)	65	DJINKIC I. (BIH)
64	ZIZAK N. (CRO)	66	UTIASHVILI T. (GEO)
65	JOVANOVIC L. (SRB)	66	KOVACS M. (HUN)
66	SWIDWA R. (POL)	67	ZIZAK N. (CRO)
67		67	DURDEVIC A. (BIH)
68		68	BABAICENKO T. (LTU)
		68	MARCZAK D. (POL)
			MARCZAK D. (POL)

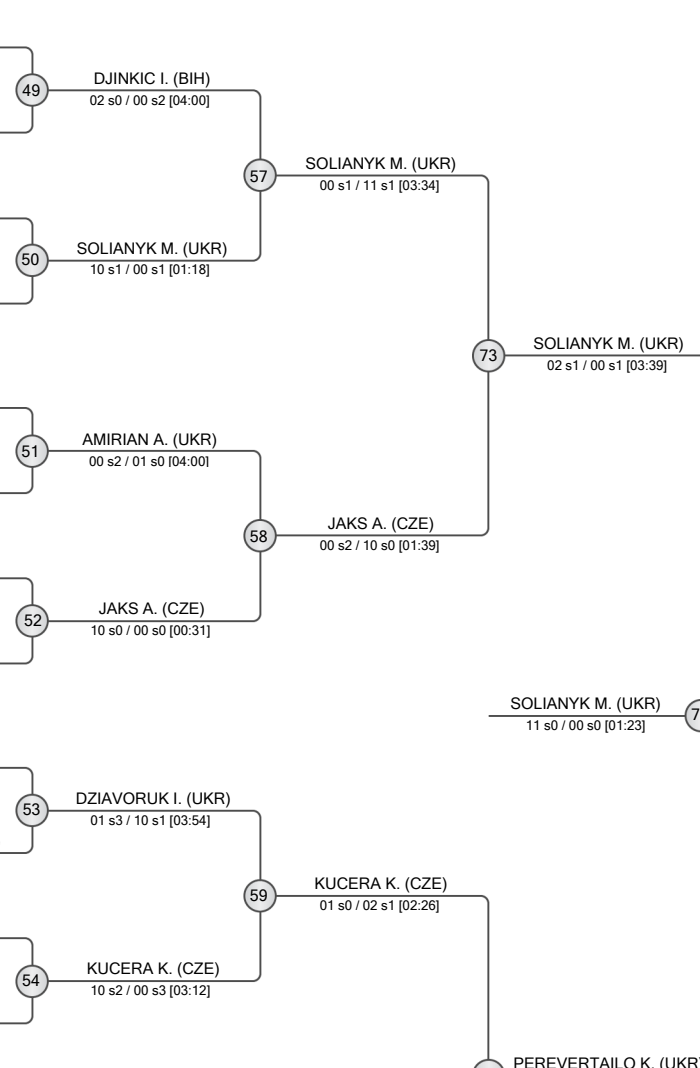

FINAL RESULTS	
1.	SOLIANYK Mykhailo (UKR)
2.	PEREVERTAILO Kyrylo (UKR)
3.	DJINKIC Ivano (BIH)
3.	JAKS Adam (CZE)
5.	KUCERA Kristian (CZE)
7.	MARCZAK Derek (POL)
7.	AMIRIAN Artur (UKR)
7.	ZIZAK Nikola (CRO)





Samorin Cadet European Cup 2024

Slovakia, Samorin, 23-24 Mar 2024

-90 kg

Men (24)

POOL A

	MILICEVIC Ivan	BIH
	KOWALCZYK Aleksander	POL
	VALKOVIC Ronald	SVK
	LEBID Dmytro	UKR
	IVANOV Dobromir	BUL
	BUTA Denis	ROU

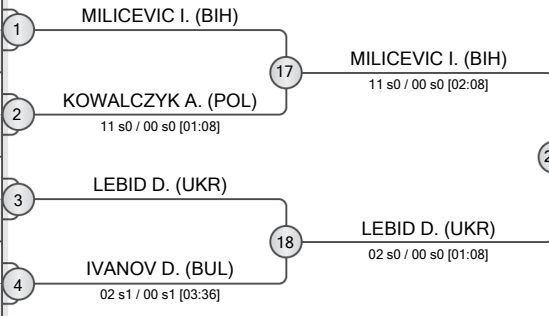

POOL B

	YERULANULY Sanzhar	KAZ
	SVATEK Jozef	SVK
	PETRAUSKAS Majus	LTU
	SPYRYDONOV Daniil	UKR
	BULATOVIC Pavle	MNE
	RICHTER Mikulas	CZE

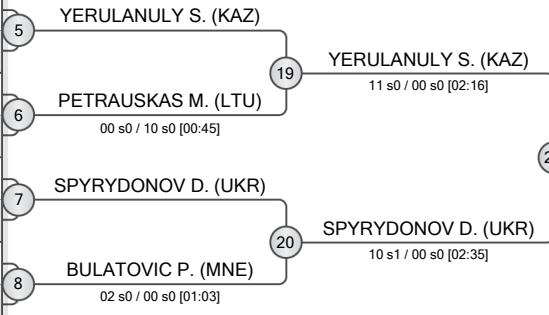

POOL C

	DINCA Alexandru	ROU
	UZAN Amit Amos	ISR
	KOSTELIDIS Angelos	GRE
	GENYS Majus	LTU
	MORAVCIK Maximilian	SVK
	MARKOV Nikola	BUL

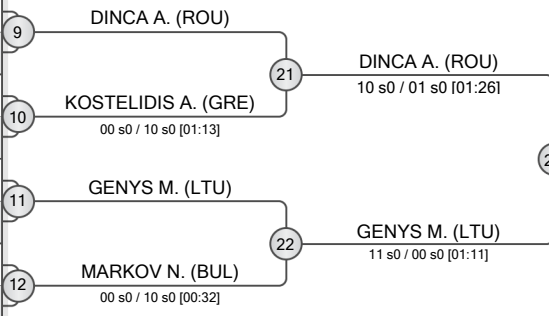

POOL D

	SAMOILOV Arkadii	UKR
	LASZCZOK Nikodem	POL
	HECKO Daniel	SVK
	FOUKAL Ondrej	CZE
	CHIKVAIDZE Saba	GEO
	KORODI Zsombor	HUN

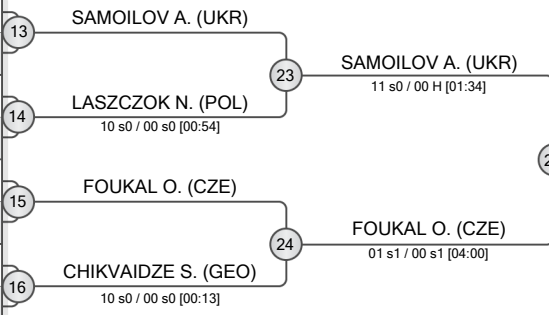

REPECHAGE

29	IVANOV D. (BUL)
30	PETRAUSKAS M. (LTU)
31	KOSTELIDIS A. (GRE)
32	LASZCZOK N. (POL)
33	MILICEVIC I. (BIH)
34	PETRAUSKAS M. (LTU)
35	GENYS M. (LTU)
36	FOUKAL O. (CZE)

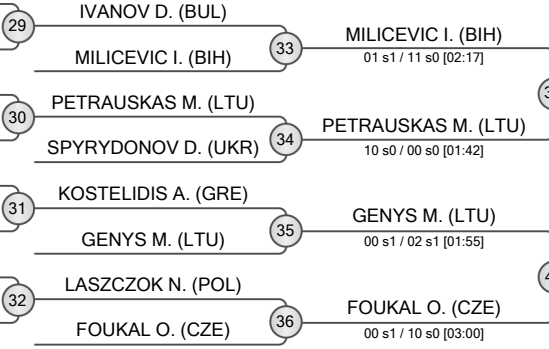

FINAL RESULTS

1.	SAMOILOV Arkadii	UKR
2.	YERULANULY Sanzhar	KAZ
3.	DINCA Alexandru	ROU
3.	LEBID Dmytro	UKR
5.	PETRAUSKAS Majus	LTU
5.	FOUKAL Ondrej	CZE
7.	MILICEVIC Ivan	BIH
7.	GENYS Majus	LTU





Samorin Cadet European Cup 2024

Slovakia, Samorin, 23-24 Mar 2024

+ 90 kg
Men (15)

POOL A

	IVANKOVIC Luka	CRO
	NYSANBAY Dinmukhammed	KAZ
	SIMON Viktor	MNE

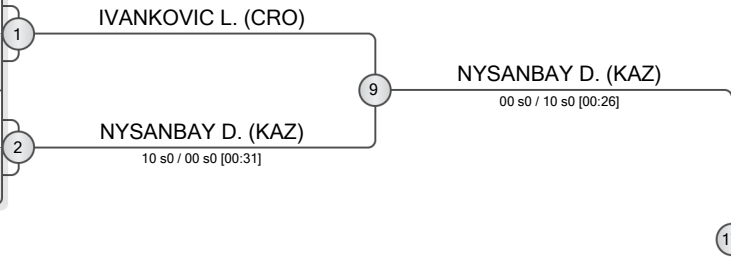

POOL B

	BURES Adam	CZE
	SHYSHOV Mykhailo	UKR
	KHACHATRYAN Anton	POL
	SVIANADZE Nodari	GEO

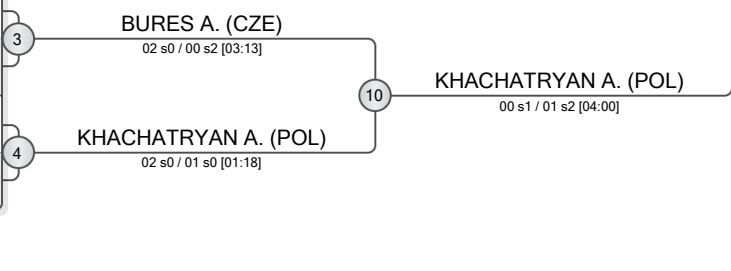

POOL C

	FESENKO Oleh	UKR
	TUGUI David	ROU
	SKODA Melichar	CZE
	IOKHMUSASHVILI Merab	GEO

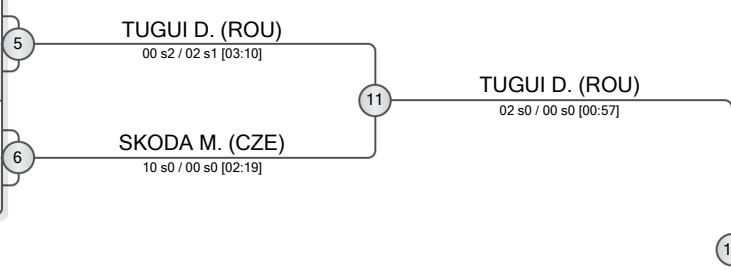

POOL D

	SZEKERES Abel	HUN
	TRUHLAR Martin	CZE
	RAKHMATULLA Mansur	KAZ
	STANEV Zdravko	BUL

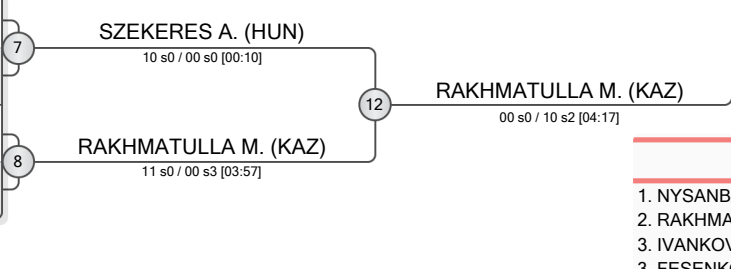

FINAL RESULTS		
1.	NYSANBAY Dinmukhammed	KAZ
2.	RAKHMATULLA Mansur	KAZ
3.	IVANKOVIC Luka	CRO
3.	FESENKO Oleh	UKR
5.	TUGUI David	ROU
7.	KHACHATRYAN Anton	POL
7.	SZEKERES Abel	HUN

REPECHAGE

SIMON V. (MNE)	13	IVANKOVIC L. (CRO)
IVANKOVIC L. (CRO)	14	BURES A. (CZE)
SVIANADZE N. (GEO)	15	FESENKO O. (UKR)
SKODA M. (CZE)	16	SZEKERES A. (HUN)

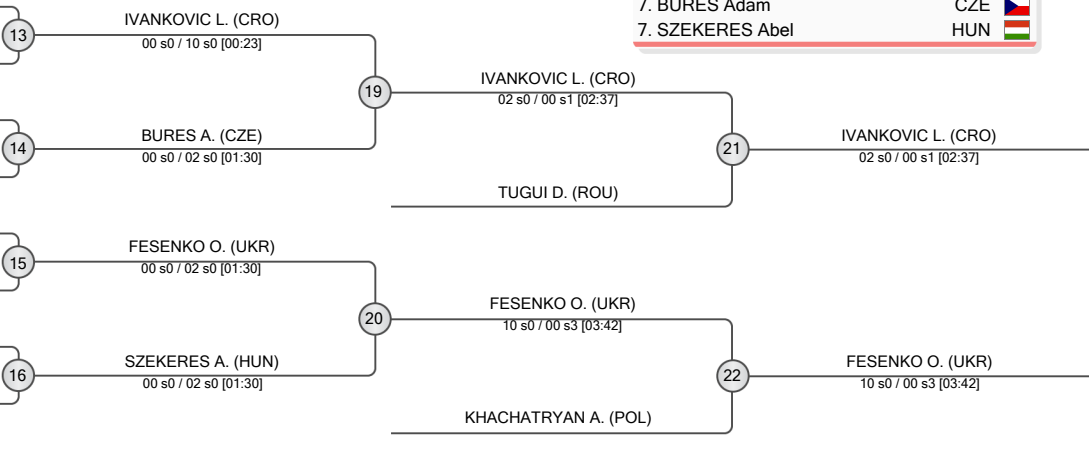

POOL A

	WALENDZIK Sandra	POL
	ALTYBAIKYZY Kamila	KAZ

1 WALENDZIK S. (POL)

10 s1 / 00 s2 [04:53]

POOL B

	TANACKOV Marija	SRB
	ABDUKADYROVA Sevinch	KAZ

2 ABDUKADYROVA S. (KAZ)

00 s1 / 01 s1 [04:00]

POOL C

	GORANOVIC Katarina	SRB
	SHVAIGERT Zlata	KAZ

3 SHVAIGERT Z. (KAZ)

00 s2 / 10 s2 [07:42]

POOL D

	VASILEVA Ema	BUL
	BLASZCZYK Julia	POL

4 BLASZCZYK J. (POL)

00 s0 / 10 s0 [00:38]

REPECHAGE

ALTYBAIKYZY K. (KAZ)	7	TANACKOV M. (SRB)
TANACKOV M. (SRB)		00 s0 / 10 s0 [00:00]

7 TANACKOV M. (SRB)

00 s0 / 10 s0 [00:00]

GORANOVIC K. (SRB)	8	GORANOVIC K. (SRB)
VASILEVA E. (BUL)		01 s0 / 00 s2 [04:00]

8 GORANOVIC K. (SRB)

01 s0 / 00 s2 [04:00]

GORANOVIC K. (SRB)	10	ABDUKADYROVA S. (KAZ)
VASILEVA E. (BUL)		01 s2 / 00 s1 [10:45]

10 ABDUKADYROVA S. (KAZ)

01 s2 / 00 s1 [10:45]

5 WALENDZIK S. (POL)

01 s2 / 00 s0 [06:35]

6 SHVAIGERT Z. (KAZ)

01 s1 / 00 s0 [04:00]

11 WALENDZIK S. (POL)

10 s1 / 00 s0 [01:24]

FINAL RESULTS

- | | | |
|-------------------------|-----|--|
| 1. WALENDZIK Sandra | POL | |
| 2. SHVAIGERT Zlata | KAZ | |
| 3. TANACKOV Marija | SRB | |
| 3. ABDUKADYROVA Sevinch | KAZ | |
| 5. BLASZCZYK Julia | POL | |
| 5. GORANOVIC Katarina | SRB | |



Samorin Cadet European Cup 2024

Slovakia, Samorin, 23-24 Mar 2024

-44 kg

Women (15)

POOL A

	TOMANKOVA Patricia	SVK
	NAUKENOVA Aizat	KAZ
	VASILEVA Raya	BUL

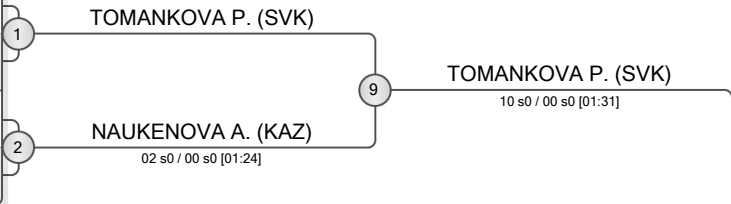

POOL B

	POTOK Nina	POL
	RUSLANOVA Assel	KAZ
	PROLIC Natalija	SRB
	PAPAI Stella	HUN

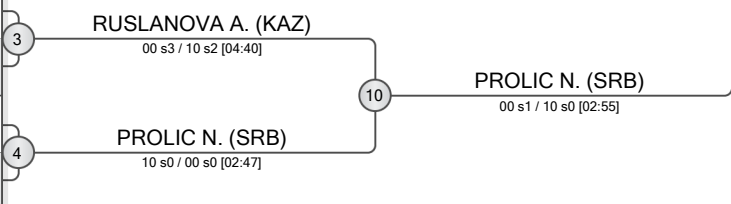

POOL C

	GABAY Yuval	ISR
	PETRENKO Liliia	UKR
	SERBAN Denisa	ROU
	SKUBEL Nicola	POL

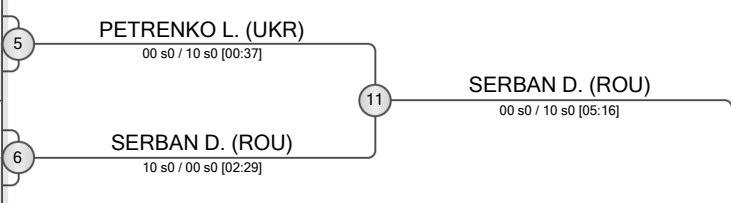

POOL D

	POTOK Natasza	POL
	MATEJKOVA Teresa	SVK
	GRIGOROVA Kalina	BUL
	SEITZHANOVA Ainara	KAZ

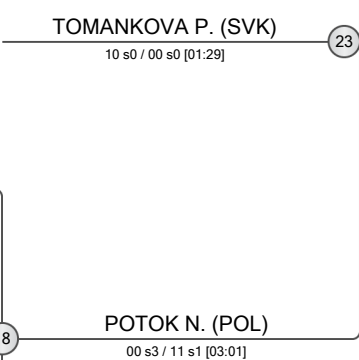
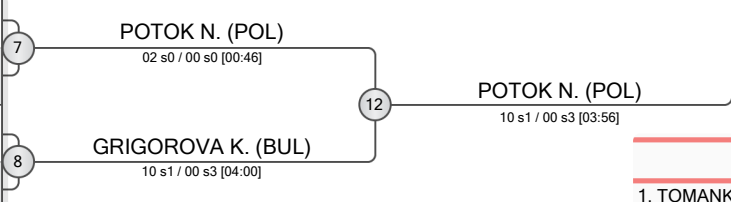

FINAL RESULTS		
1.	TOMANKOVA Patricia	SVK
2.	POTOK Natasza	POL
3.	NAUKENOVA Aizat	KAZ
3.	PROLIC Natalija	SRB
5.	SERBAN Denisa	ROU
5.	PETRENKO Liliia	UKR
7.	RUSLANOVA Assel	KAZ
7.	GRIGOROVA Kalina	BUL

REPECHAGE

13	NAUKENOVA A. (KAZ)
14	RUSLANOVA A. (KAZ)
15	PETRENKO L. (UKR)
16	GRIGOROVA K. (BUL)

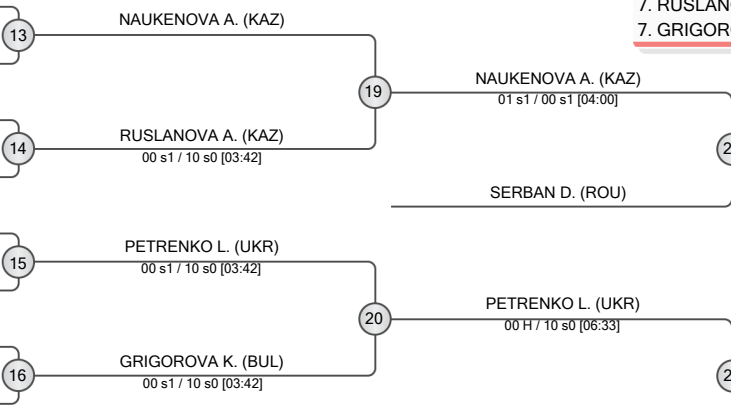



Samorin Cadet European Cup 2024

Slovakia, Samorin, 23-24 Mar 2024

-48 kg
Women (21)

POOL A

	TWAROWSKA Barbara	POL
	LEVCHENKO Anastasiia	UKR
	VARDAROVA Kalina	BUL
	TAGAY Symbat	KAZ
	MASLACOVA Laura	SVK

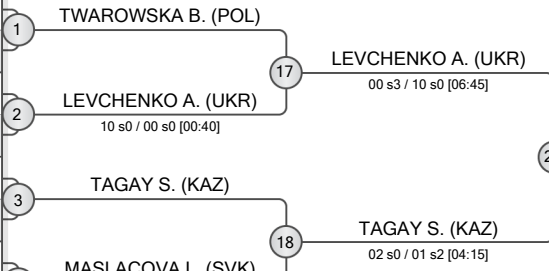

POOL B

	TUCAJ Martina	CRO
	KOVACHEVA Preslava	BUL
	STOLLAROVA Sofia	SVK
	MANDA Lorena	ROU
	SPICKOVA Sofie	CZE
	WISNIEWSKA Hanna	POL

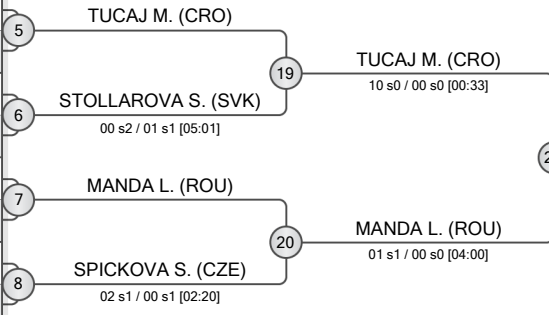

POOL C

	KARPUS Daria	UKR
	CZERWINSKA-KOWAR Roksana	POL
	LETONIA Dora	CRO
	ANTOVA Zoya	BUL
	HERTA Gabriela	MDA

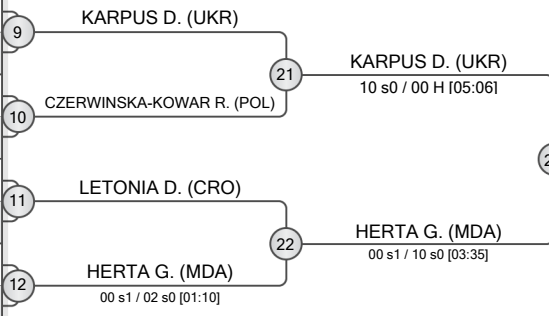

POOL D

	KRIZOVA Kristina Lili	SVK
	MUNTEANU Ana Maria	ROU
	YAMASHEVA Alina	KAZ
	BANOVACKI Teodora	SRB
	PODYMSKA Nina	POL

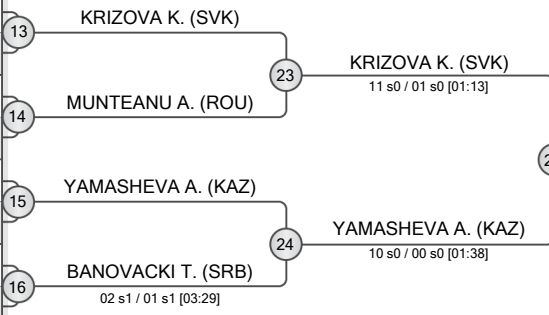

FINAL RESULTS	
1.	LEVCHENKO Anastasiia
2.	YAMASHEVA Alina
3.	TWAROWSKA Barbara
3.	KRIZOVA Kristina Lili
5.	HERTA Gabriela
5.	TUCAJ Martina
7.	MANDA Lorena
7.	LETONIA Dora

REPECHAGE

VARDAROVA K. (BUL)	29 TWAROWSKA B. (POL)
TWAROWSKA B. (POL)	30 STOLLAROVA S. (SVK)
STOLLAROVA S. (SVK)	31 LETONIA D. (CRO)
ANTOVA Z. (BUL)	32 BANOVACKI T. (SRB)
LETONIA D. (CRO)	33 TAGAY S. (KAZ)
LETONIA D. (CRO)	34 MANDA L. (ROU)
KARPUS D. (UKR)	35 LETONIA D. (CRO)
BANOVACKI T. (SRB)	36 KRIZOVA K. (SVK)

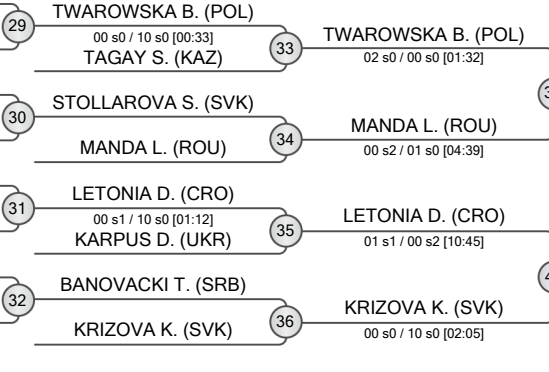



Samorin Cadet European Cup 2024

Slovakia, Samorin, 23-24 Mar 2024

-52 kg
Women (31)

POOL A

	BARISIC Laura	CRO
	PAVLENCO Elizaveta	MDA
	KEJDOVA Emma	CZE
	PERRY Gil	ISR
	SEVERYN Anastasiia	UKR
	KHEGAY Kira	KAZ
	VUZNAKOVA Eva	SVK

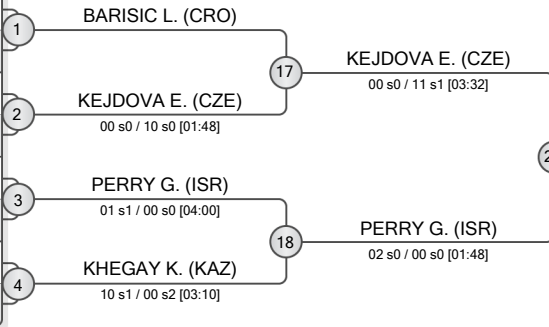

POOL B

	VONDRAKOVA Lada	CZE
	STOEVA Andrea	BUL
	LUPTAKOVA Paulina	SVK
	HARANI Talya	ISR
	NOWOSAD Roza	POL
	KELAVA Maja	SLO
	YEMELIANOVA Yelyzaveta	UKR
	STOJANOV Lenka	SRB

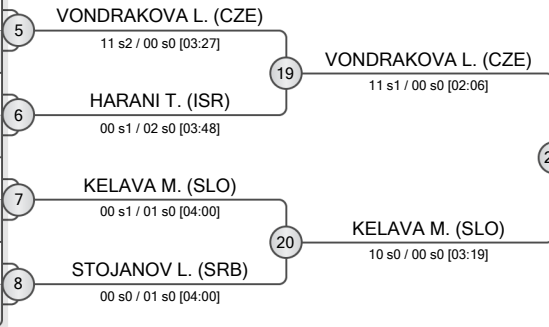

POOL C

	VODIANNIA Melaniia	UKR
	VOJDOVA Zoe	SVK
	YAHAV Yali	ISR
	HULOVA Karolina	CZE
	DODAJ Sidorela	KOS
	TEISANU Teodora	ROU
	BECKER Libi	ISR
	SUPYGALIYEVA Fatima	KAZ

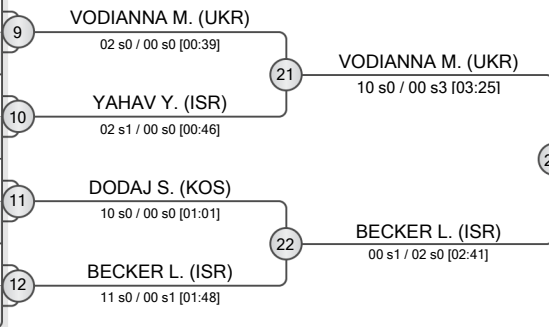

POOL D

	SAVIC Bojana	SRB
	KOSH NITZKY Maya	ISR
	HRECHKA Sofia	UKR
	MOHAROS Zsofia	HUN
	ZIJADE Enise	KOS
	PANAYOTOVA Yoana	BUL
	MOS Marika	POL
	VADOVICOVA Vivien	SVK

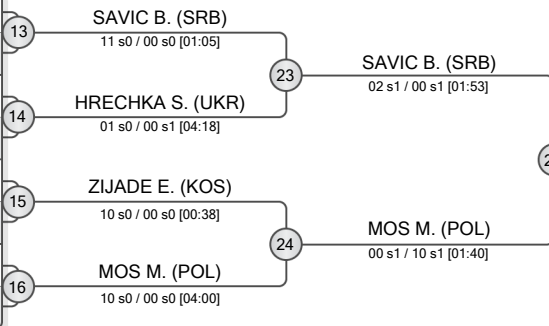

REPECHAGE

29 SEVERYN A. (UKR)	SEVERYN A. (UKR)
30 HARANI T. (ISR)	HARANI T. (ISR)
31 DODAJ S. (KOS)	SUPYGALIYEVA F. (KAZ)
32 HRECHKA S. (UKR)	HRECHKA S. (UKR)

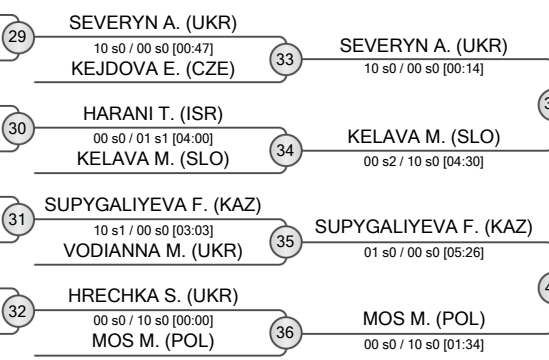

FINAL RESULTS	
1. PERRY Gil	ISR
2. BECKER Libi	ISR
3. SEVERYN Anastasiia	UKR
3. VONDRAKOVA Lada	CZE
5. SAVIC Bojana	SRB
5. SUPYGALIYEVA Fatima	KAZ
7. KELAVA Maja	SLO
7. MOS Marika	POL





Samorin Cadet European Cup 2024

Slovakia, Samorin, 23-24 Mar 2024

-57 kg

Women (30)

POOL A

	ZAKROISKY Hili	ISR
	SAMOILIUK Diana	UKR
	ZIVANOVIC Tijana	SRB
	KOLAKOWSKA Zuzanna	POL
	GABOR Mihaela	MDA
	SUBOVA Kristina	SVK
	KOZHAMSEITOVA Aida	KAZ

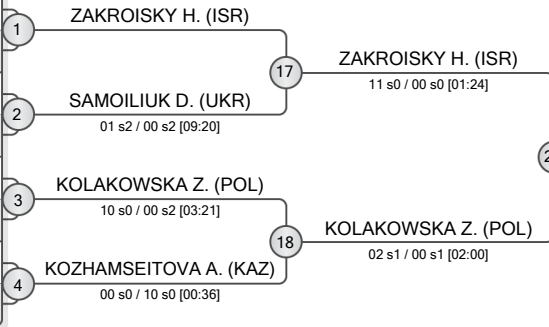

POOL B

	SCERBOVA Amalie	CZE
	SARKANY Greta	SVK
	PAVEN Amelia	ROU
	SOCOLSKY Adi	ISR
	KUKA Fiona	KOS
	BOLTIVANOVA Lea	SVK
	RUSINOVA Yuliana	BUL
	JANUSZ Urszula	POL

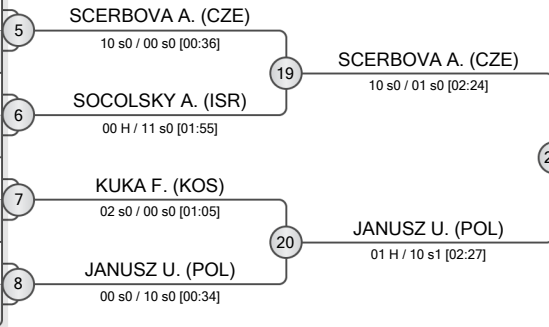

POOL C

	BIELAWSKA Emilia	POL
	GANOVSKA Sofia	SVK
	HERMANOVA Karolina	CZE
	BALBEK Diana	UKR
	MILOSAVLJEV Milica	SRB
	SKOMERSIC Maria	CRO
	POPESCU Daliana	ROU

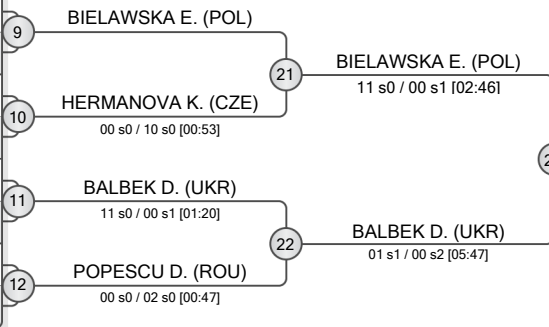

POOL D

	SKERYTE Ugne	LTU
	BOZHINOVA Denitsa	BUL
	DANISOVA Ema	SVK
	KAKARANTZA Ioanna	GRE
	MARKOVICSOVA Emma	SVK
	CEPELAKOVA Lucie	CZE
	BADASH Naama	ISR
	DUTCA Tatiana	MDA

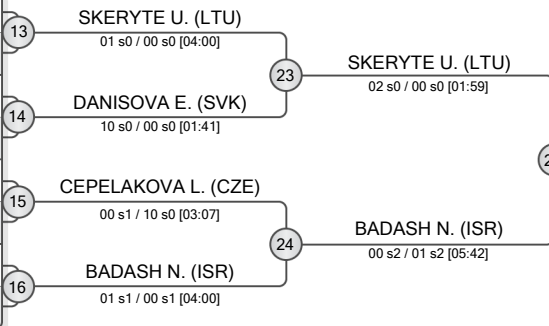

FINAL RESULTS	
1.	SKERYTE Ugne LTU
2.	ZAKROISKY Hili ISR
3.	SOCOLSKY Adi ISR
3.	BALBEK Diana UKR
5.	BIELAWSKA Emilia POL
5.	SCERBOVA Amalie CZE
7.	SAMOILIUK Diana UKR
7.	BADASH Naama ISR

REPECHAGE

SAMOILIUK D. (UKR)	29 SAMOILIUK D. (UKR)	33 SAMOILIUK D. (UKR)
SARKANY G. (SVK)	30 SOCOLSKY A. (ISR)	34 SOCOLSKY A. (ISR)
SOCOLSKY A. (ISR)	30 SOCOLSKY A. (ISR)	34 SOCOLSKY A. (ISR)
HERMANOVA K. (CZE)	31 HERMANOVA K. (CZE)	35 BALBEK D. (UKR)
BOZHINOVA D. (BUL)	31 HERMANOVA K. (CZE)	35 BALBEK D. (UKR)
DANISOVA E. (SVK)	32 DANISOVA E. (SVK)	36 BADASH N. (ISR)
DANISOVA E. (SVK)	32 DANISOVA E. (SVK)	36 BADASH N. (ISR)

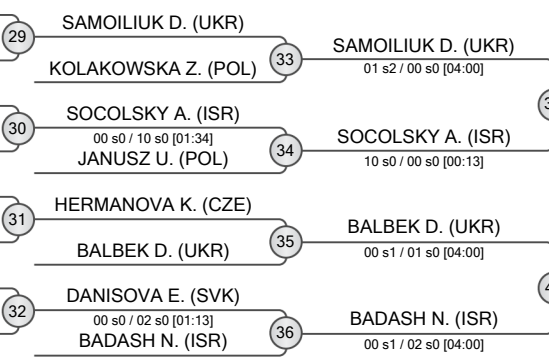



Samorin Cadet European Cup 2024

Slovakia, Samorin, 23-24 Mar 2024

-63 kg

Women (36)

POOL A

	HANNA Zaitseva	POL	1
	KADYROVA Saya	KAZ	2
	MITEVA Elizabeth	BUL	3
	BOICHENKO Daria	UKR	4
	BABJAKOVA Viktoria	SVK	5
	BESKER Ana	CRO	6
	VUKICEVIC Dunja	SRB	7
	JURCIKOVA Viktorie	CZE	8
	HOLESOVA Alzbeta	SVK	9

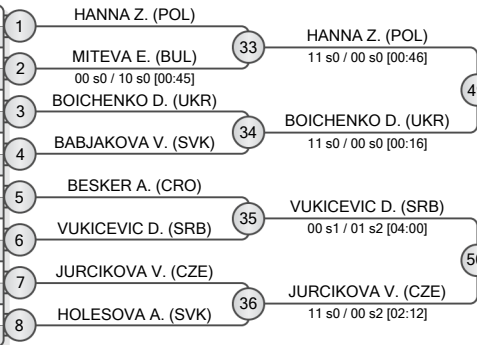

POOL B

	MATSIRIDI Sophia	GRE	9
	SEBOVA Zoja	SVK	10
	SOTNYK Viktoriia	UKR	11
	ORLOVIC Olga	SRB	12
	SCHENK Magdalena	POL	13
	MUSIIENKO Albina	UKR	14
	KOCJAN Neza	SLO	15
	DRDAKOVA Martina	SVK	16
	BOB Isabel	ROU	17

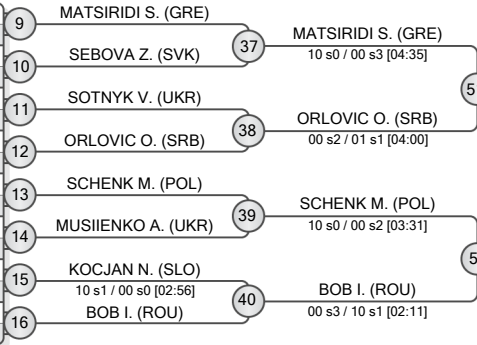

POOL C

	PTASINSKA Amelia	POL	17
	ZELENAKOVA Zuzana	SVK	18
	HORIASHYNA Sofia	UKR	19
	IMERI Sara	CRO	20
	OPANASENKO Kristina	UKR	21
	KOZHASSOVA Saule	KAZ	22
	ROGELJ Tina	SLO	23
	ADAMACHI Maya	ROU	24
	MATUSZEKOVA Paula	SVK	25

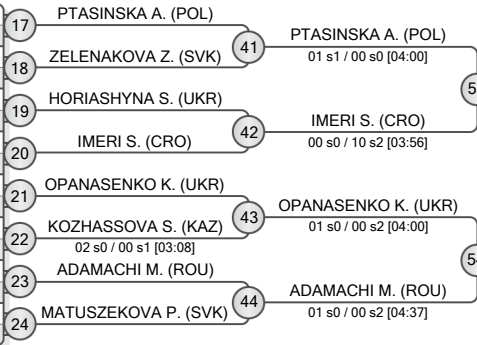

POOL D

	TSURKAN Ilariia	UKR	25
	HAMBOROVA Zuzana	SVK	26
	TODOROVA Elitsa	BUL	27
	VLAHOVIC Teodora	MNE	28
	DOSBERGEN Dilnaz	KAZ	29
	LEHOTKAIIOVA Zuzana	SVK	30
	IMERI Esra	CRO	31
	VOZNIUK Liudmyla	UKR	32
	PAVLOVIC Nevena	SRB	33

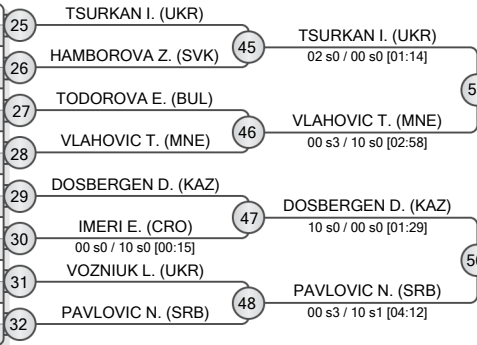

FINAL RESULTS		
1.	TSURKAN Ilariia	UKR
2.	ORLOVIC Olga	SRB
3.	BOB Isabel	ROU
3.	HANNA Zaitseva	POL
5.	PTASINSKA Amelia	POL
5.	PAVLOVIC Nevena	SRB
7.	BOICHENKO Daria	UKR
7.	OPANASENKO Kristina	UKR

REPECHAGE

MITEVA E. (BUL)	61	MITEVA E. (BUL)	65	BOICHENKO D. (UKR)	69
SOTNYK V. (UKR)	62	MATSIRIDI S. (GRE)	66	VUKICEVIC D. (SRB)	70
ZELENAKOVA Z. (SVK)	63	IMERI S. (CRO)	67	BOB I. (ROU)	71
HAMBOROVA Z. (SVK)	64	VLAHOVIC T. (MNE)	68	PAVLOVIC N. (SRB)	72

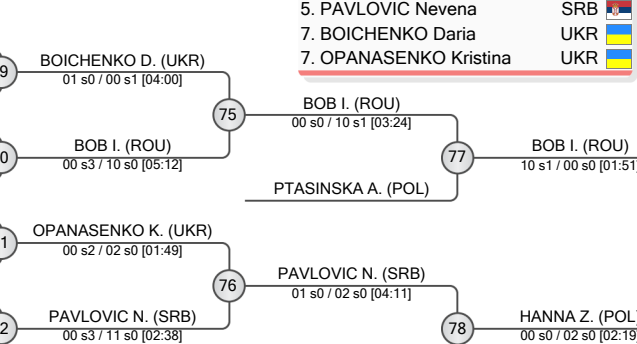
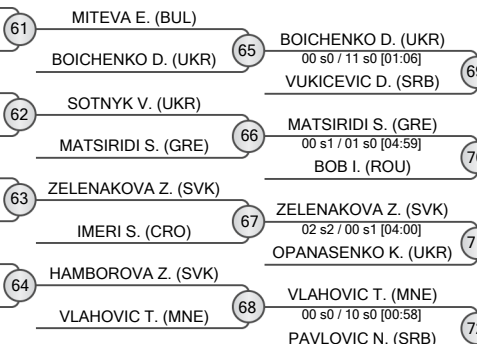



Samorin Cadet European Cup 2024

Slovakia, Samorin, 23-24 Mar 2024

-70 kg
Women (25)

POOL A

	OLIINYK-KORNIKO Anna	UKR
	SARKOZI Zsuzsa	HUN
	BOGDAN Smaranda	ROU
	KLINGER Johanna Elisabeth	BIH
	APOSTOLOVA Emili	BUL
	MICHAIL Maria	CYP
	RADOSINSKA Karin	SVK

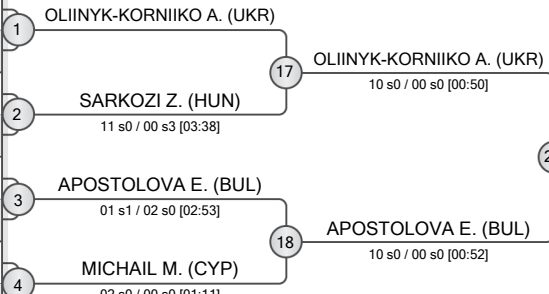

POOL B

	SLACEK Nika	CRO
	RADAKOVIC Milica	SRB
	FEHER Zara	ROU
	SKORUPINSKA Martyna	POL
	MRAVCAKOVA Karolina	SVK
	GRUBISIC CABO Nina	BIH

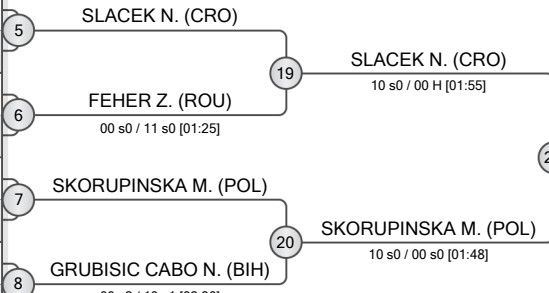

POOL C

	JAAFAR Nadie	BUL
	HUDIKA Vita	CRO
	BIZQUIAZO-CRISTOREAN Francesca	ROU
	USURELU Alexia	ROU
	MITAKIDOU Ilektra-Evangelia	GRE
	STRAK Oliwia	POL

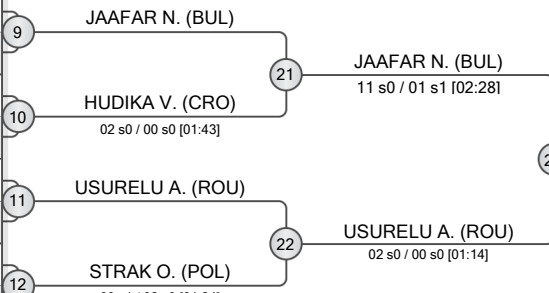

POOL D

	IBATOLLA Anissa	KAZ
	TKACHOVA Anna	UKR
	SUCIU Anamaria	ROU
	YERGALI Tomiris	KAZ
	DZIDIC Korina	BIH
	HOKSOVA Viktoria	SVK

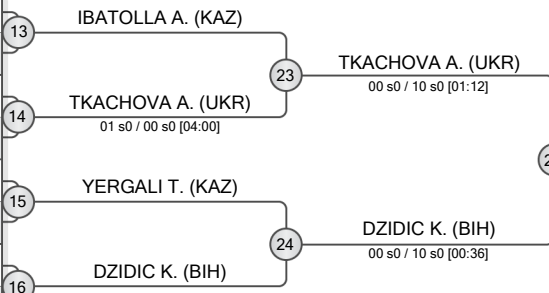

FINAL RESULTS	
1.	SLACEK Nika CRO
2.	JAAFAR Nadie BUL
3.	DZIDIC Korina BIH
5.	USURELU Alexia ROU
5.	SKORUPINSKA Martyna POL
7.	SARKOZI Zsuzsa HUN
7.	YERGALI Tomiris KAZ

REPECHAGE

SARKOZI Z. (HUN)	29	SARKOZI Z. (HUN)	33
FEHER Z. (ROU)	30	SKORUPINSKA M. (POL)	34
HUDIKA V. (CRO)	31	USURELU A. (ROU)	35
HOKSOVA V. (SVK)		YERGALI T. (KAZ)	32
YERGALI T. (KAZ)		TKACHOVA A. (UKR)	36

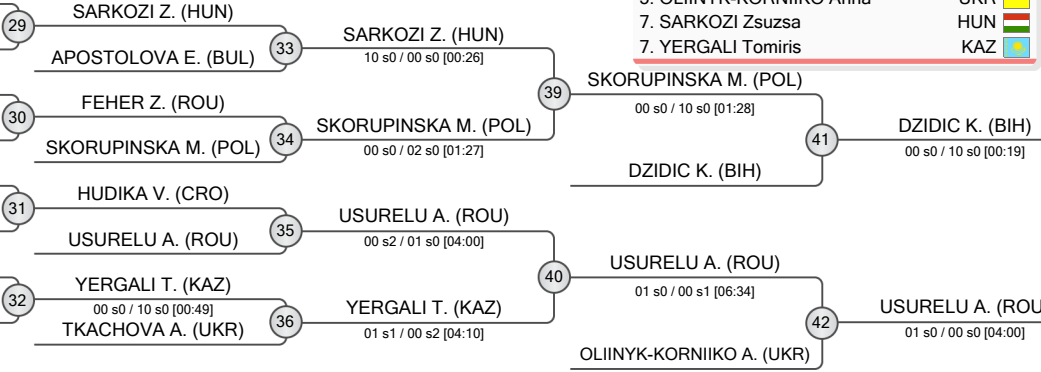



Samorin Cadet European Cup 2024

Slovakia, Samorin, 23-24 Mar 2024

+ 70 kg

Women (13)

POOL A

	KASZPEROVA Kristyna	CZE
	ZAREBA Nikola	POL
	HOES Tali	ISR

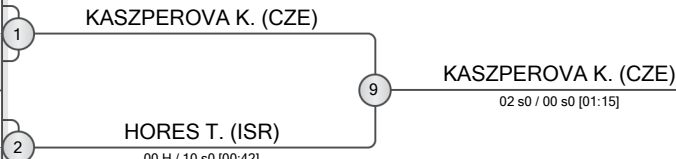

POOL B

	TROKA Julia	POL
	EININGE Saule	LTU
	COCIORBA Ioana	ROU
	SOTSKA Tetiana	UKR

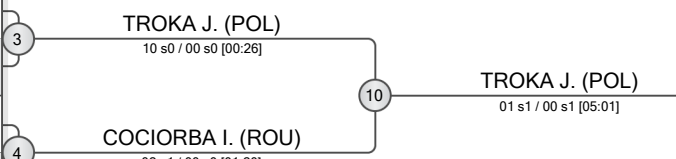

POOL C

	WIDLAK Nicole	POL
	KROUZKOVA Anna	CZE
	KUPRIKOVA Daryna	UKR

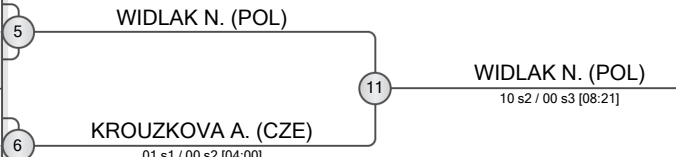

POOL D

	FILKOROVA Nina	SVK
	DUMANKYZY Aiyzada	KAZ
	MILOSEVIC Jovana	SRB

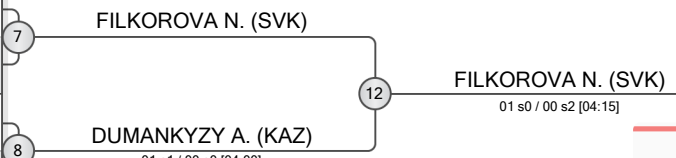

REPECHAGE

13 HORES T. (ISR)	14 EININGE S. (LTU)	15 KROUZKOVA A. (CZE)	16 DUMANKYZY A. (KAZ)
-------------------	---------------------	-----------------------	-----------------------

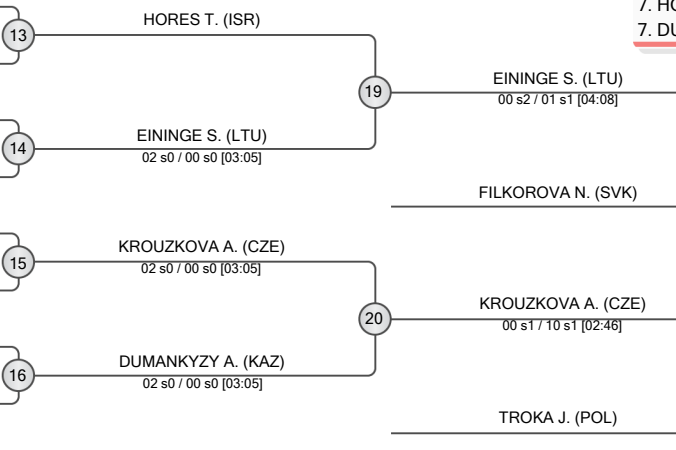

FINAL RESULTS		
1.	KASZPEROVA Kristyna	CZE
2.	WIDLAK Nicole	POL
3.	FILKOROVA Nina	SVK
3.	TROKA Julia	POL
5.	EININGE Saule	LTU
5.	KROUZKOVA Anna	CZE
7.	HOES Tali	ISR
7.	DUMANKYZY Aiyzada	KAZ

