



Teplice Cadet European Cup 2023

Czech Republic, Teplice, 8-9 Apr 2023

-50 kg

Men (59)

POOL A

1	GALO Bence (HUN)	33	GALO B. (HUN)
2	GUALANDI Matteo (ITA)	34	YAMAMOTO L. (BRA)
3	MAGURA Danilo (SRB)	35	TAMARY B. (ISR)
4	AYZELMAN Yonatan (AUS)	36	ISAYEV A. (BEL)
5	IONITA David (ROU)	37	TROFYMOV I. (UKR)
6	SEGURA RIERA Santiago (FRA)	38	RODRIGUES J. (BRA)
7	YAMAMOTO Lucas (BRA)	39	POBLOCKI S. (SWE)
8	TAMARY Ben (ISR)	40	YILDIZ A. (TUR)
9	PFANDL Jan (AUT)	41	SILVA V. (BRA)
10	ALIYEV Rasul (AZE)	42	MUSIN D. (UKR)
11	KRAUSE Simon Lucas (SUI)	43	CORI S. (SUI)
12	ISAYEV Askhab (BEL)	44	PORRELLI M. (ITA)
13	GRUBER Maximilian Koh (GER)	45	BALSEVICIUS M. (LTU)
14	GRIGORJEVS Artjoms (LAT)	46	GUIKEMA M. (NED)
15	YAVUZ Arda Taha (TUR)	47	TSUKAMOTO M. (BRA)

POOL B

9	TROFYMOV Ivan (UKR)	37	TROFYMOV I. (UKR)
10	KOJC Keno (SLO)	38	RODRIGUES J. (BRA)
11	BASSI Thibaud (SUI)	39	POBLOCKI S. (SWE)
12	SMEJKAL Stepan (CZE)	40	YILDIZ A. (TUR)
13	HEINEMANN Finn (GER)	41	SILVA V. (BRA)
14	RODRIGUES Joao (BRA)	42	MUSIN D. (UKR)
15	STEFANEK Hunor (HUN)	43	CORI S. (SUI)
16	POBLOCKI Samir (SWE)	44	PORRELLI M. (ITA)
17	BUWALDA Riemer-Jelte (NED)	45	BALSEVICIUS M. (LTU)
18	HILL Laurence (GBR)	46	GUIKEMA M. (NED)
19	YILDIZ Alisan (TUR)	47	TSUKAMOTO M. (BRA)
20	HAMELRIJCK Gabriel (BEL)	48	GLASER J. (GER)
21	BUETTNER Willy (GER)	49	GALO B. (HUN)
22	LLAMAS VIEJO Alex (ESP)	50	TAMARY B. (ISR)

POOL C

17	LEBRETON Pierre (FRA)	41	SILVA V. (BRA)
18	NICOLA Martim (POR)	42	MUSIN D. (UKR)
19	SILVA Victor Hugo (BRA)	43	CORI S. (SUI)
20	KUNYIK Botond (HUN)	44	PORRELLI M. (ITA)
21	GUNTER Ibrahim (TUR)	45	BALSEVICIUS M. (LTU)
22	LAPERRE Finn (BEL)	46	GUIKEMA M. (NED)
23	MUSIN Daniil (UKR)	47	TSUKAMOTO M. (BRA)
24	MUNTSUROV Mohamed (AUT)	48	GLASER J. (GER)
25	CORI Silvano (SUI)	49	GALO B. (HUN)
26	RATE Mario (ROU)	50	TAMARY B. (ISR)
27	MILJIC Srdjan (SRB)	51	RODRIGUES J. (BRA)
28	GALIA Jan (CZE)	52	YILDIZ A. (TUR)
29	POLYCHRONIDIS Alexandros (GRE)	53	SILVA V. (BRA)
30	PORRELLI Michele (ITA)	54	PORRELLI M. (ITA)
31	THEN Carl (GER)	55	CROCIANI F. (ITA)

POOL D

25	CROCIANI Francesco (ITA)	45	CROCIANI F. (ITA)
26	WINTER Felix (GER)	46	GUIKEMA M. (NED)
27	BALSEVICIUS Martas (LTU)	47	TSUKAMOTO M. (BRA)
28	GUIKEMA Michel (NED)	48	GLASER J. (GER)
29	KULAKOV Aleksajs (LAT)	49	GALO B. (HUN)
30	AZARUMYAN Artak (EST)	50	TAMARY B. (ISR)
31	GUL Furkan Salih (TUR)	51	RODRIGUES J. (BRA)
32	MARTIN TORRES Carlos (ESP)	52	YILDIZ A. (TUR)
33	ODOR Noel (HUN)	53	SILVA V. (BRA)
34	TSUKAMOTO Matheus (BRA)	54	PORRELLI M. (ITA)
35	GINZBURG Eyal (ISR)	55	CROCIANI F. (ITA)
36	SALVI Oskar (AUT)	56	GLASER J. (GER)
37	DVORAK Petr (CZE)	57	GALO B. (HUN)
38	GLASER Julius (GER)	58	YILDIZ A. (TUR)
39	MILOSEVIC Aleksa (SRB)	59	PORRELLI M. (ITA)

REPECHAGE

61	GUALANDI M. (ITA)	65	YAMAMOTO L. (BRA)
62	HAMELRIJCK G. (BEL)	66	POBLOCKI S. (SWE)
63	LLAMAS VIEJO A. (ESP)	67	CORI S. (SUI)
64	THEN C. (GER)	68	GUIKEMA M. (NED)
65	GALIA J. (CZE)	69	YAMAMOTO L. (BRA)
66	BALSEVICIUS M. (LTU)	70	POBLOCKI S. (SWE)
67	GUIKEMA M. (NED)	71	SILVA V. (BRA)
68	GLASER J. (GER)	72	GLASER J. (GER)

FINAL RESULTS	
1.	GALO Bence (HUN)
2.	CROCIANI Francesco (ITA)
3.	PORRELLI Michele (ITA)
3.	GLASER Julius (GER)
5.	POBLOCKI Samir (SWE)
5.	YILDIZ Alisan (TUR)
7.	YAMAMOTO Lucas (BRA)
7.	SILVA Victor Hugo (BRA)





Teplice Cadet European Cup 2023

Czech Republic, Teplice, 8-9 Apr 2023

-55 kg

Men (71)

POOL A

	MICHALAK Franciszek	POL	1	MICHALAK F. (POL)
	FEKE Adam	HUN	2	FEKE A. (HUN)
	DIDZIAKIS Deminykas	LTU	3	DIDZIAKIS D. (LTU)
	TASCI Efecan	TUR	4	TASCI E. (TUR)
	DORGOSAN Alexandru	ROU	5	DORGOSAN A. (ROU)
	MOTA BENTO Cristiano	FRA	6	MOTA BENTO C. (FRA)
	KNEZ Filip	CRO	6	KNEZ F. (CRO)
	LEB Stefan	AUT	7	LEB S. (AUT)
	FORSELIUS Albin	SWE	8	FORSELIUS A. (SWE)
	JACOBS Warre	BEL	9	JACOBS W. (BEL)
	KOCHAV Yoav	ISR	10	KOCHAV Y. (ISR)
	SILVA Samuel	BRA	11	SILVA S. (BRA)
	BJELIC Nemanja	SRB	12	BJELIC N. (SRB)
	BEZPALEC Jonas	CZE	13	BEZPALEC J. (CZE)
	NAGIMULIN Alihan	GER	14	NAGIMULIN A. (GER)
	RODMAN Blake	GBR	15	RODMAN B. (GBR)
	POLISKO Ruslans	LAT	16	POLISKO R. (LAT)

POOL B

	BLAZIC Gal	SLO	17	BLAZIC G. (SLO)
	JORGIC Marko	SRB	18	JORGIC M. (SRB)
	HAMADI Ihsane	FRA	19	HAMADI I. (FRA)
	PENAS MERINO Unai	ESP	19	PENAS MERINO U. (ESP)
	SWITALA Pawel	POL	20	SWITALA P. (POL)
	MACHADO Renzo	BRA	21	MACHADO R. (BRA)
	CIRUNAS Ignas	LTU	22	CIRUNAS I. (LTU)
	MALIKOV Semen	UKR	23	MALIKOV S. (UKR)
	GIGILASHVILI Luka	GBR	24	GIGILASHVILI L. (GBR)
	DZHAMALDINOV Amsar	BEL	25	DZHAMALDINOV A. (BEL)
	SHCHEKOTIN Filipp	EST	26	SHCHEKOTIN F. (EST)
	CAETANO Diogo	POR	27	CAETANO D. (POR)
	IOVINO Michele Mario	ITA	28	IOVINO M. (ITA)
	IVANOV Cristian	MDA	29	IVANOV C. (MDA)
	HOMKA Eriks	LAT	29	HOMKA E. (LAT)
	BAUD Romain	SUI	30	BAUD R. (SUI)
	KUPPER David	GER	31	KUPPER D. (GER)
	MIRZAZADA Aykhan	AZE	32	MIRZAZADA A. (AZE)

REPECHAGE

125	BJELIC N. (SRB)
126	KUPPER D. (GER)
127	BIRKHANS T. (LAT)
128	STERZER M. (GER)

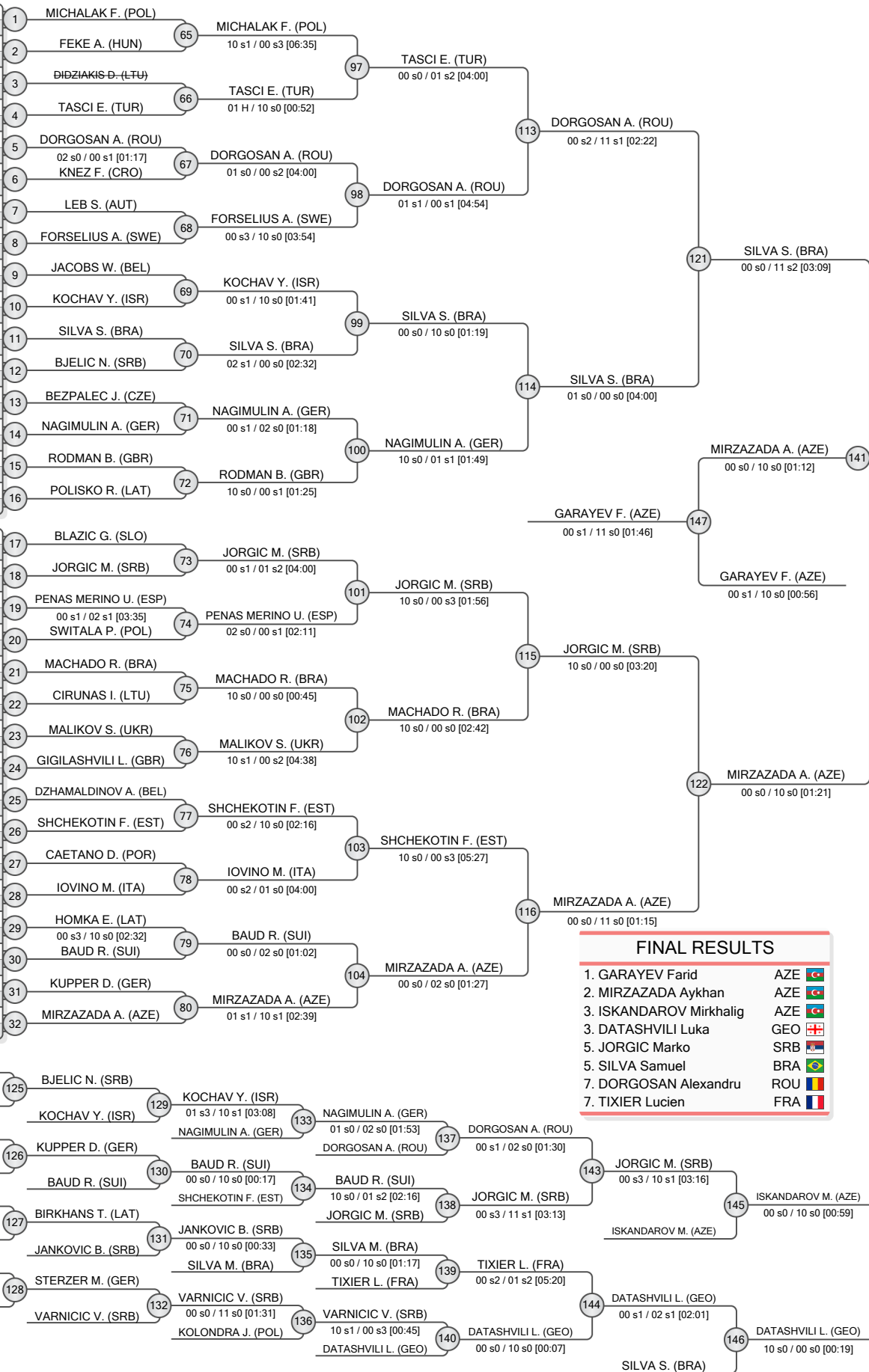



Teplice Cadet European Cup 2023

Czech Republic, Teplice, 8-9 Apr 2023

-55 kg

Men (71)

POOL C

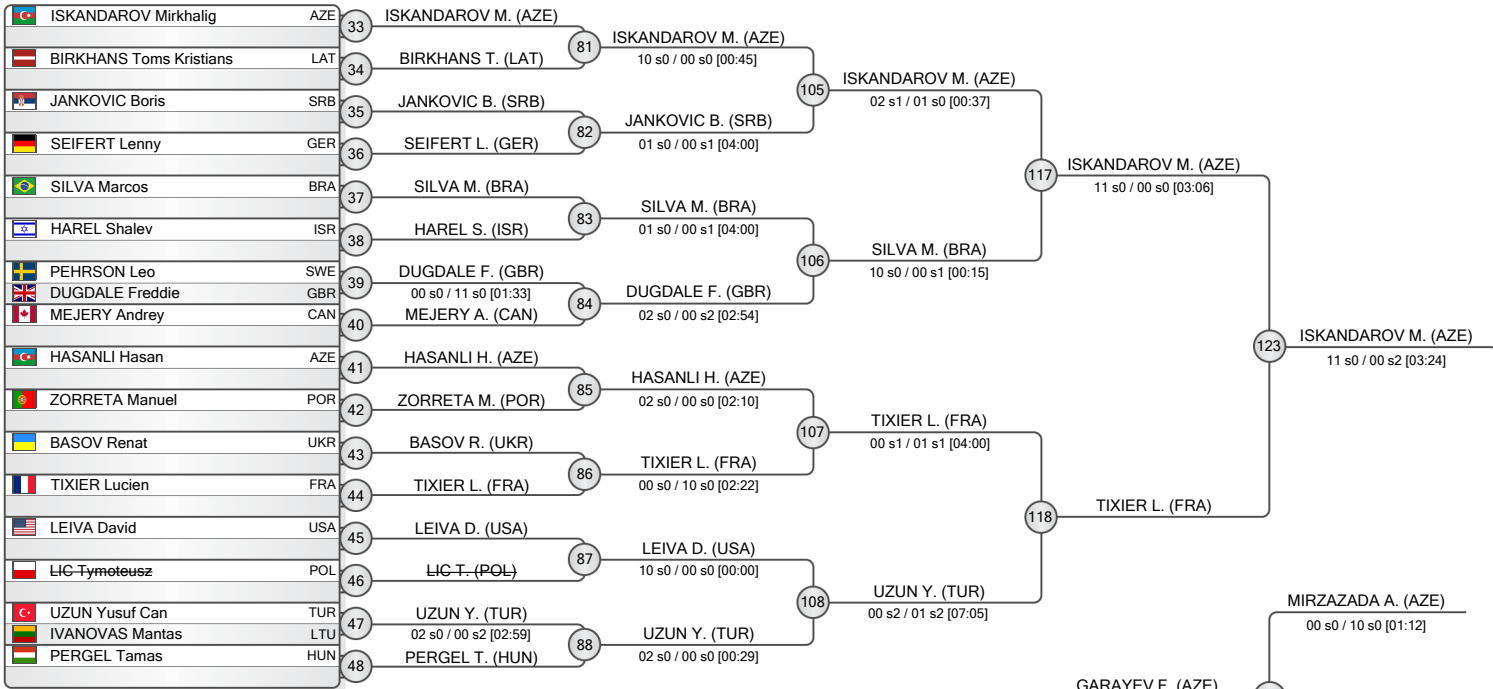

POOL D

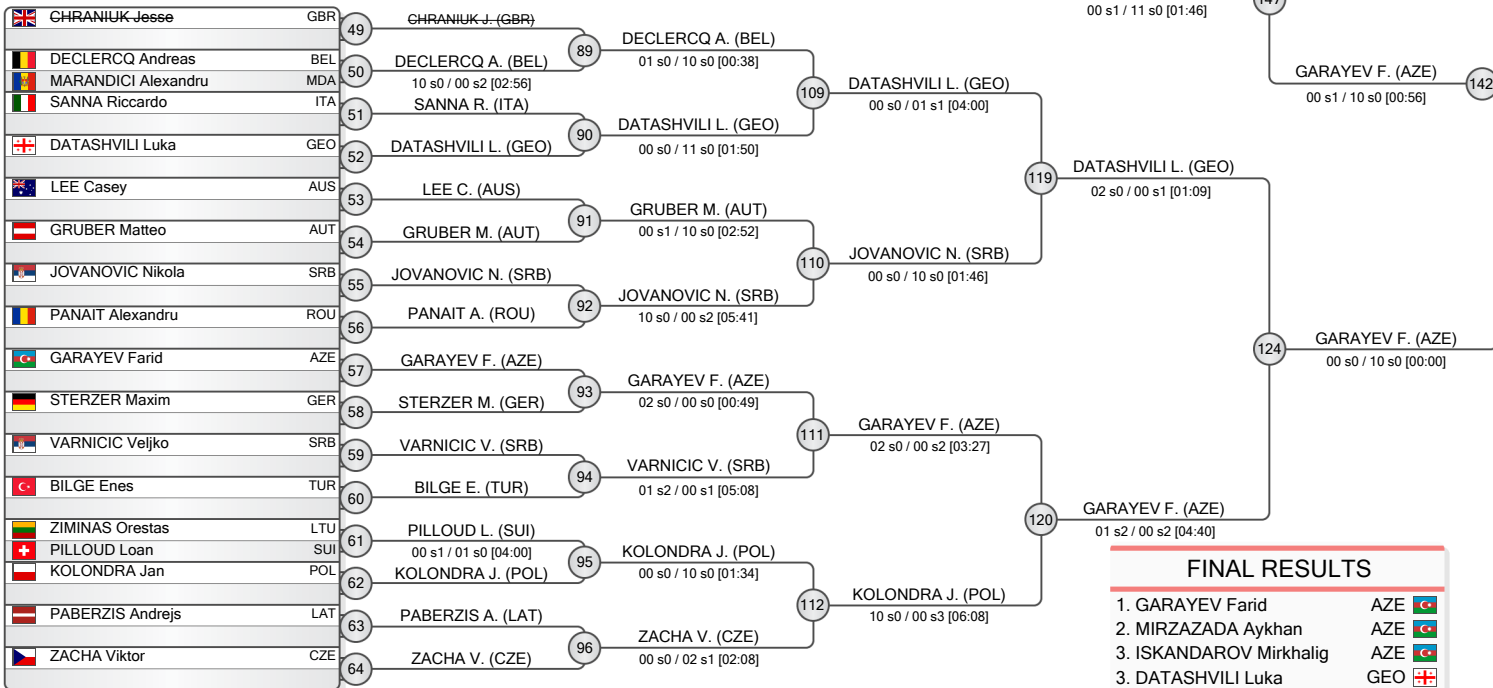

REPECHAGE

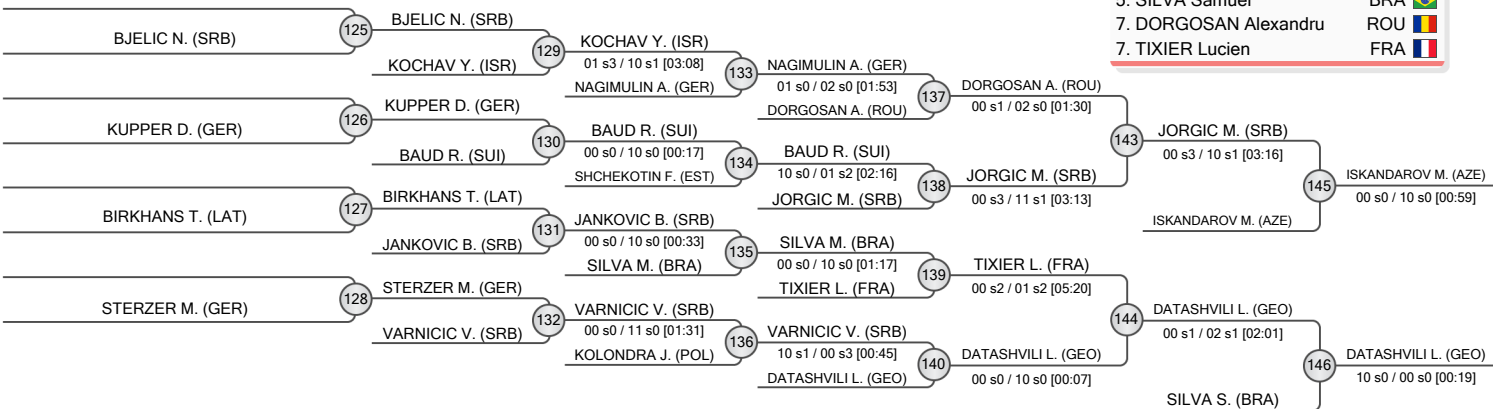



Teplice Cadet European Cup 2023

Czech Republic, Teplice, 8-9 Apr 2023

-60 kg

Men (82)

POOL A

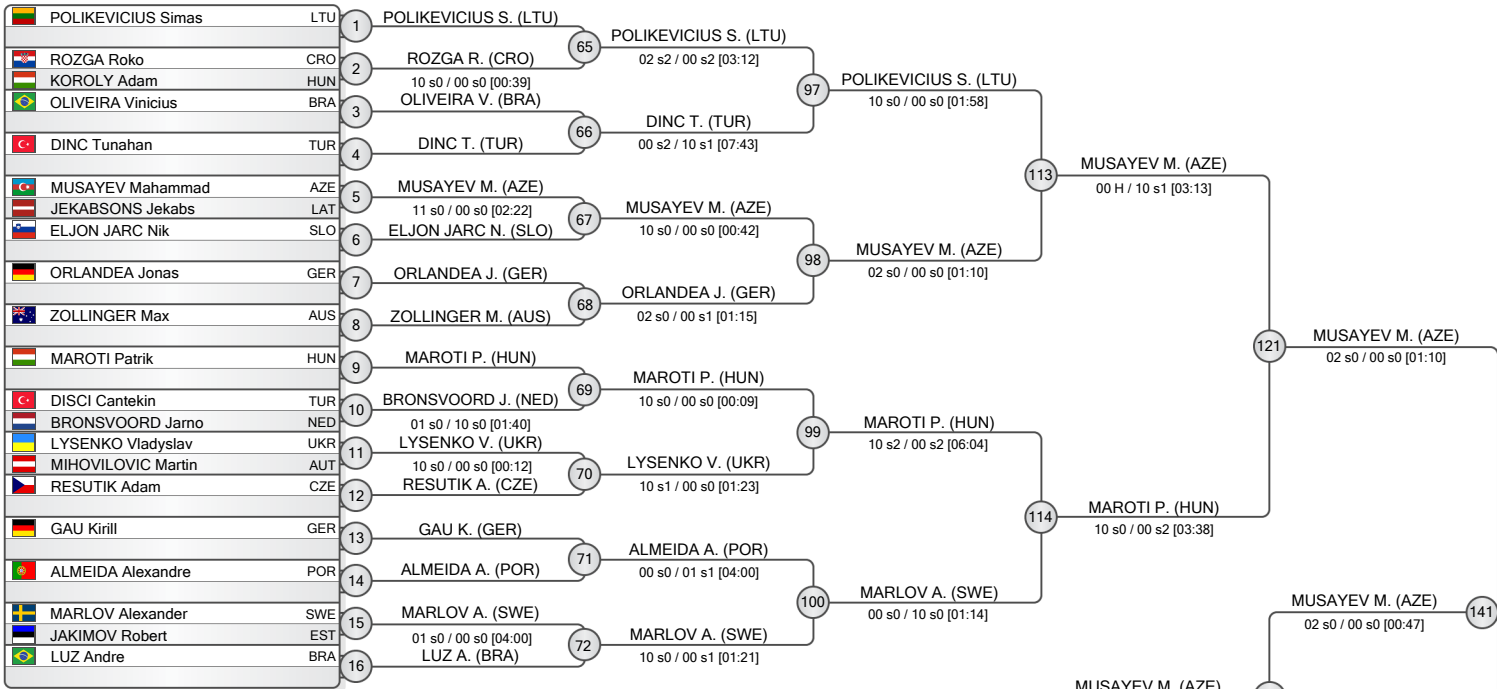

POOL B

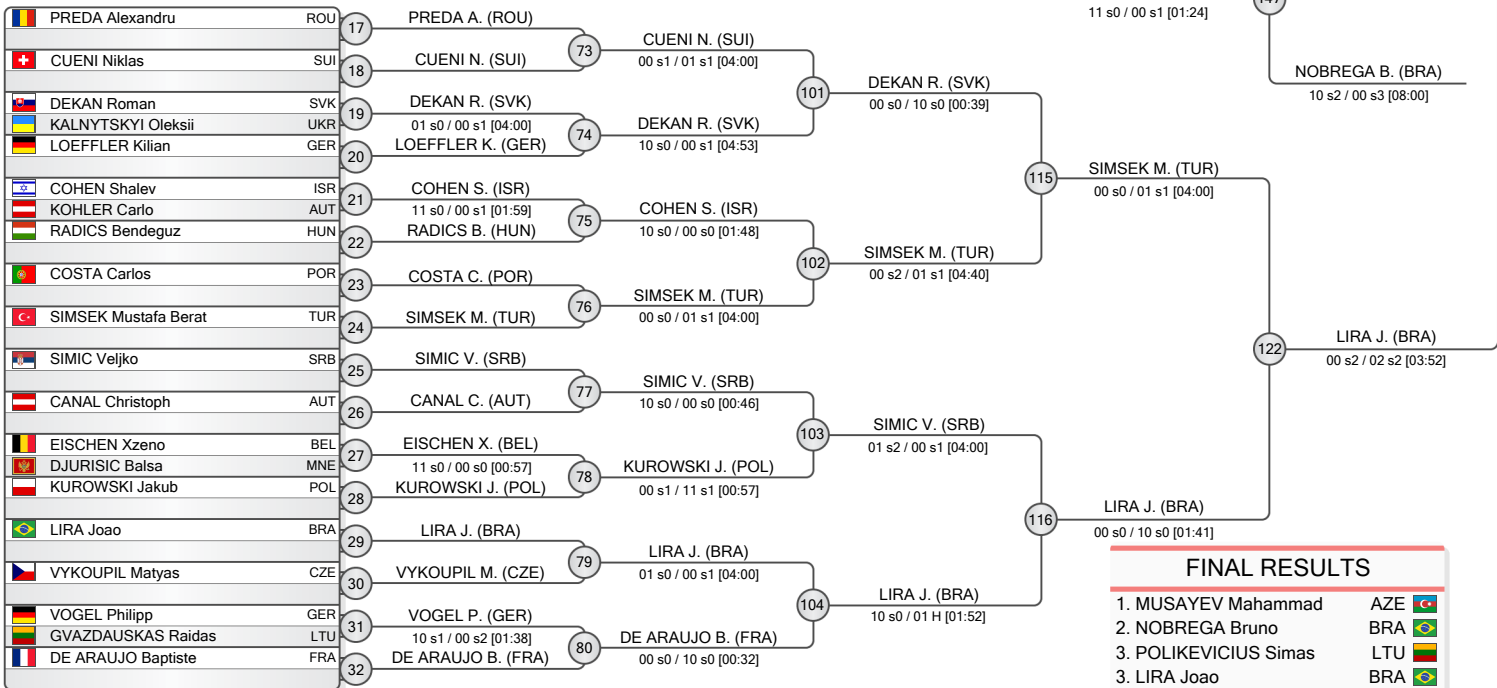

FINAL RESULTS		
1.	MUSAYEV Mahammad	AZE
2.	NOBREGA Bruno	BRA
3.	POLIKEVICIUS Simas	LTU
3.	LIRA Joao	BRA
5.	KOLLAR Sebestyen	HUN
5.	NITU Antonio	ROU
7.	SIMSEK Mustafa Berat	TUR
7.	PESTEREW Phillip	GER

REPECHAGE

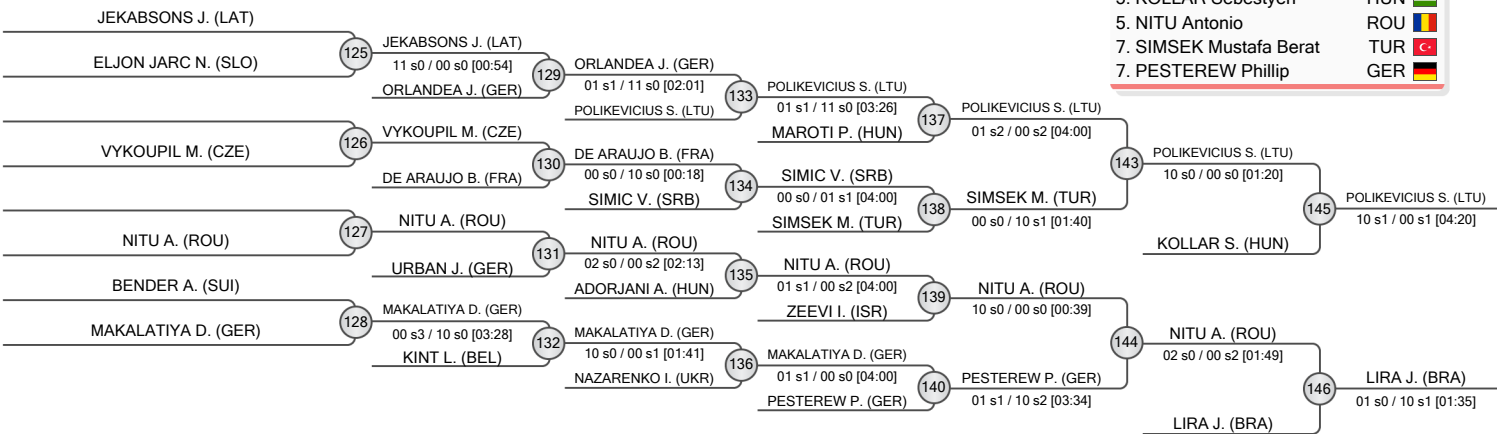



Teplice Cadet European Cup 2023

Czech Republic, Teplice, 8-9 Apr 2023

-60 kg

Men (82)

POOL C

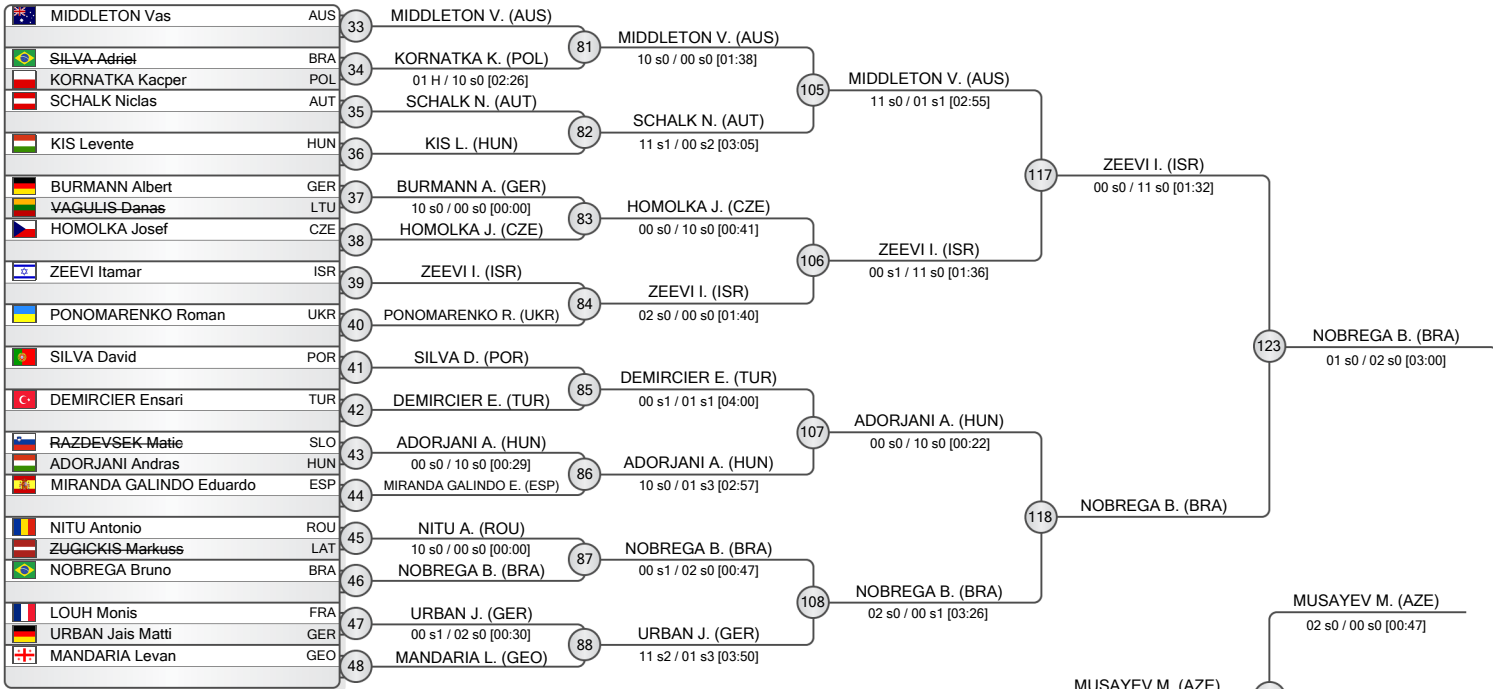

POOL D

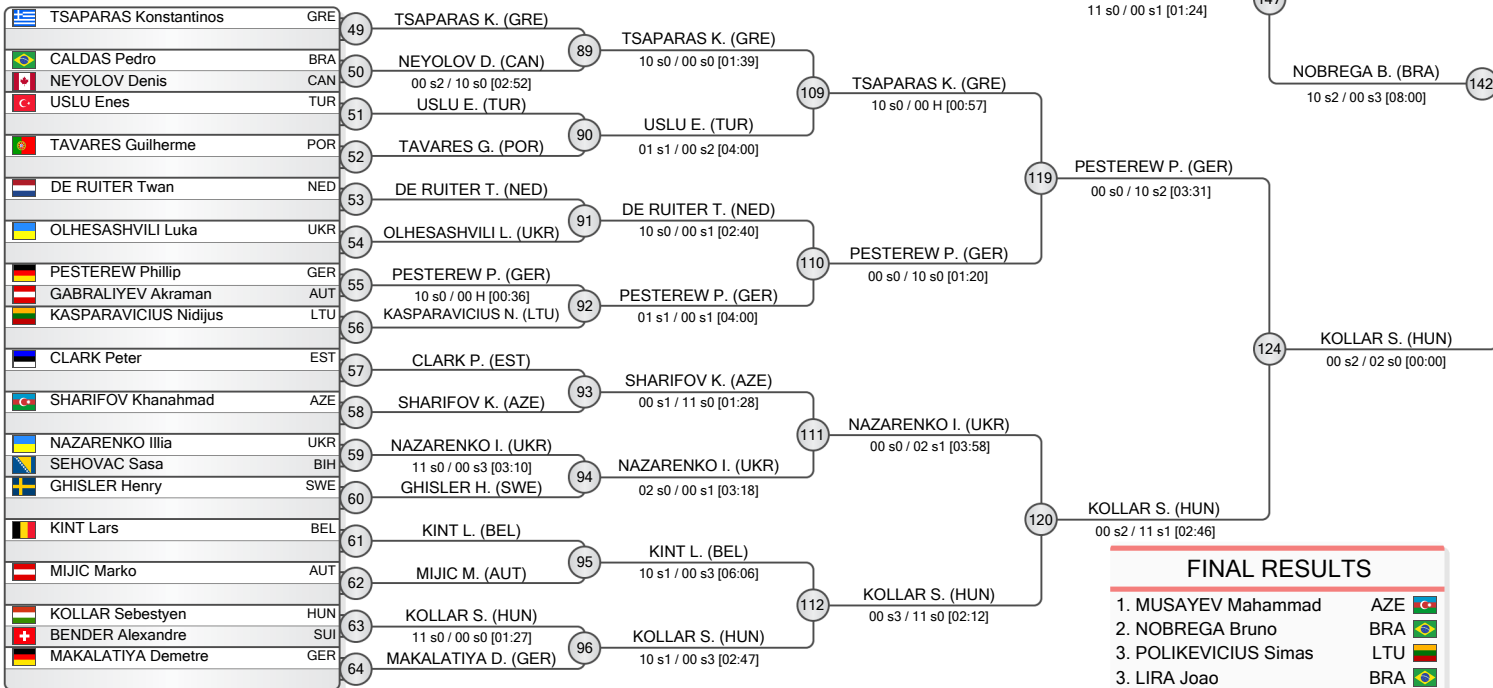

FINAL RESULTS		
1. MUSAYEV Mahammad	AZE	
2. NOBREGA Bruno	BRA	
3. POLIKEVICIUS Simas	LTU	
3. LIRA Joao	BRA	
5. KOLLAR Sebestyen	HUN	
5. NITU Antonio	ROU	
7. SIMSEK Mustafa Berat	TUR	
7. PESTEREW Phillip	GER	

REPECHAGE

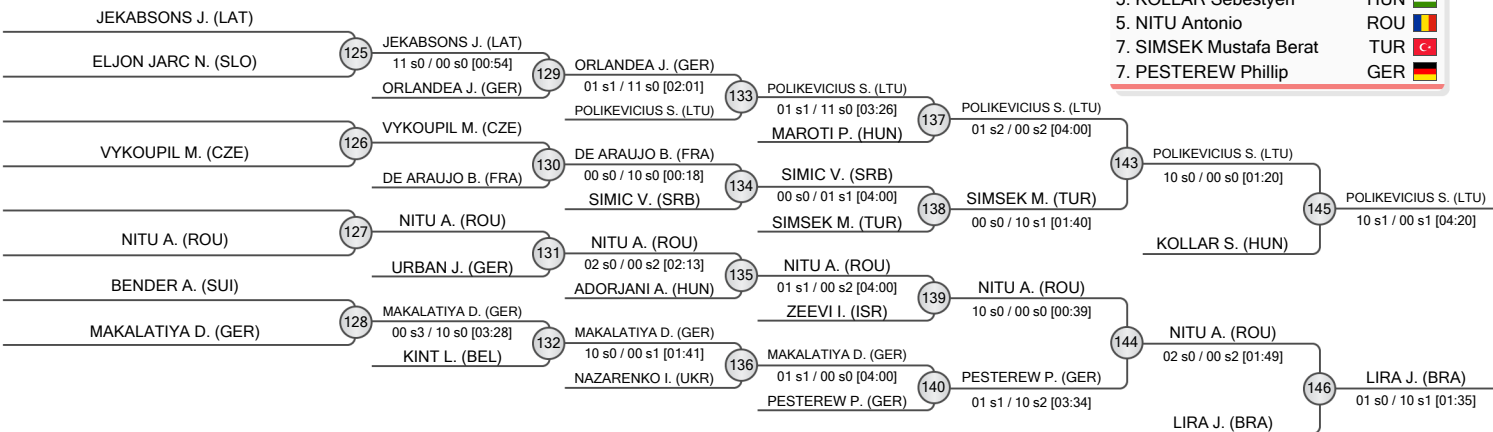



Teplice Cadet European Cup 2023

Czech Republic, Teplice, 8-9 Apr 2023

-66 kg

Men (110)

POOL A

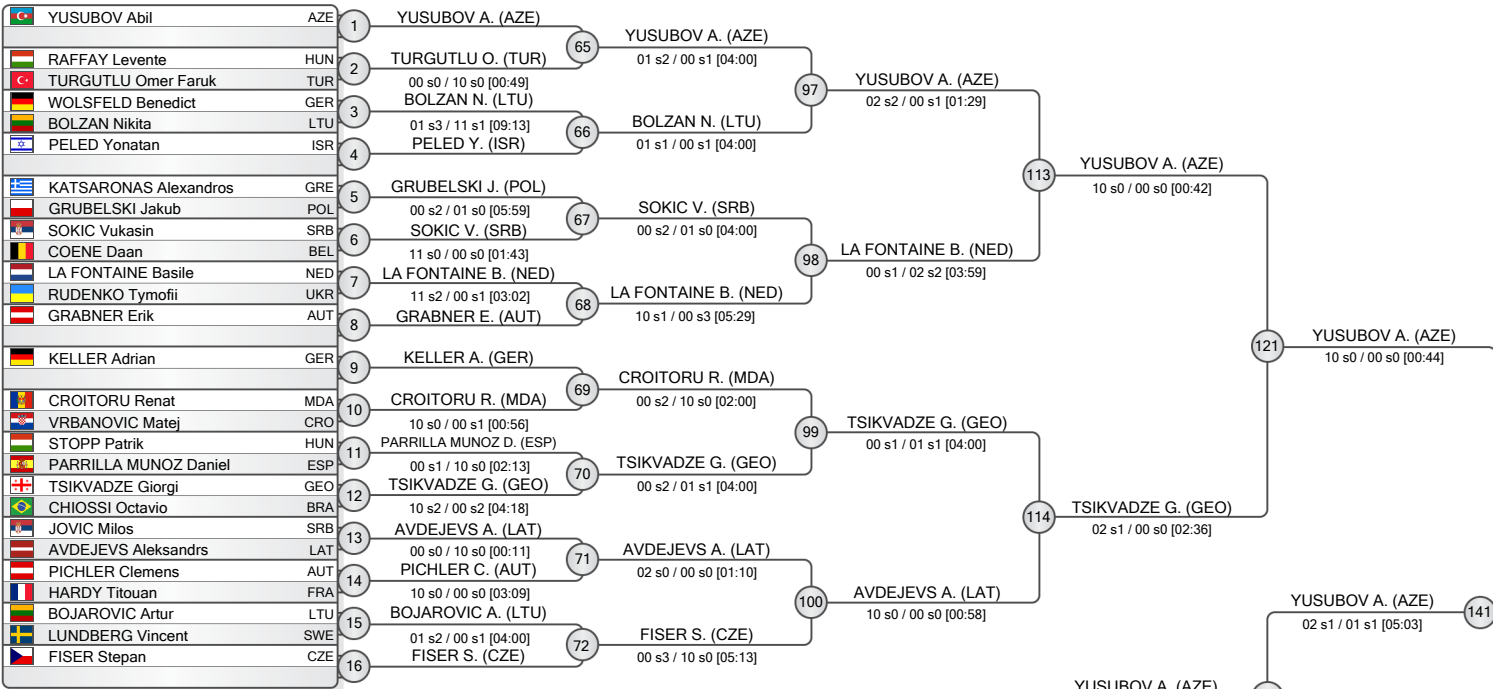

POOL B

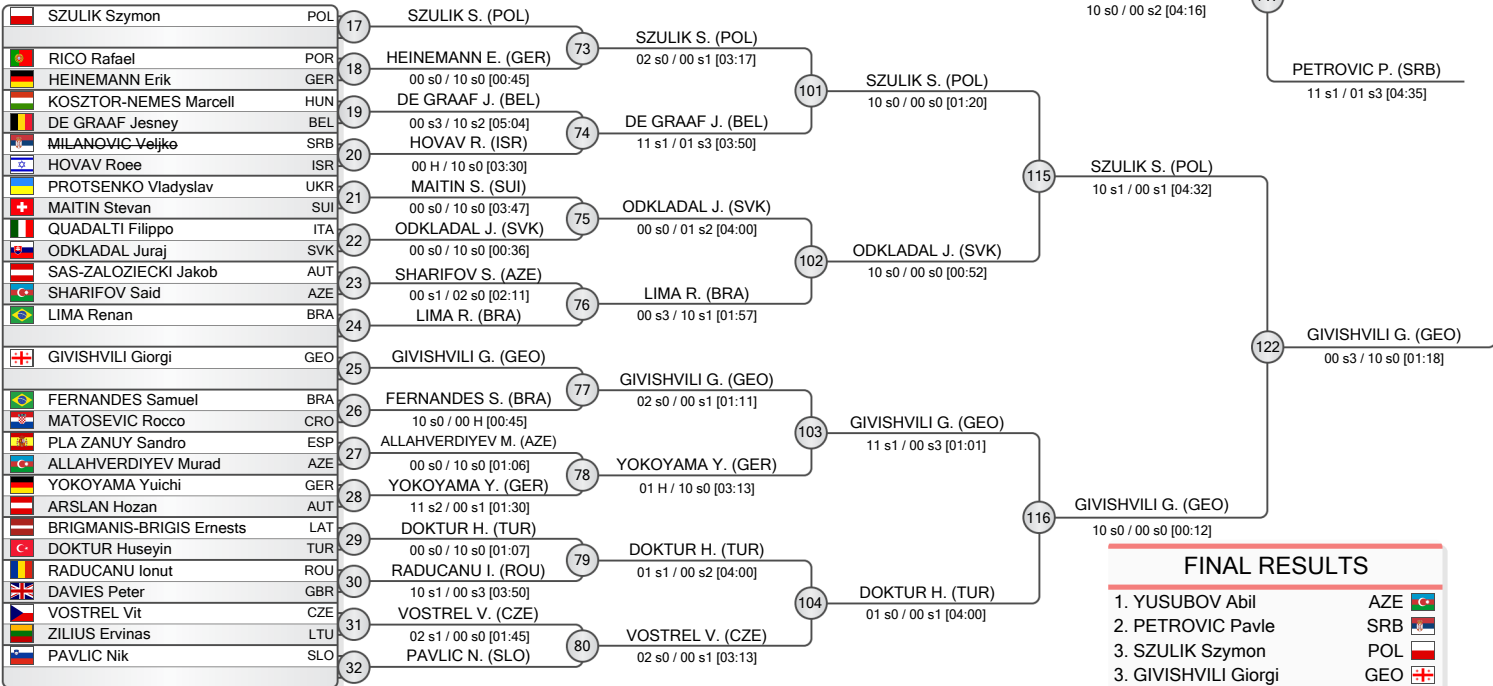

FINAL RESULTS

- YUSUBOV Abil (AZE)
- PETROVIC Pavle (SRB)
- SZULIK Szymon (POL)
- GIVISHVILI Giorgi (GEO)
- GOGINASHVILI Irakli (GBR)
- JANEIRO Rodrigo (POR)
- TURGUTLU Omer Faruk (TUR)
- MAMADOV Davlatzhon (UKR)

REPECHAGE

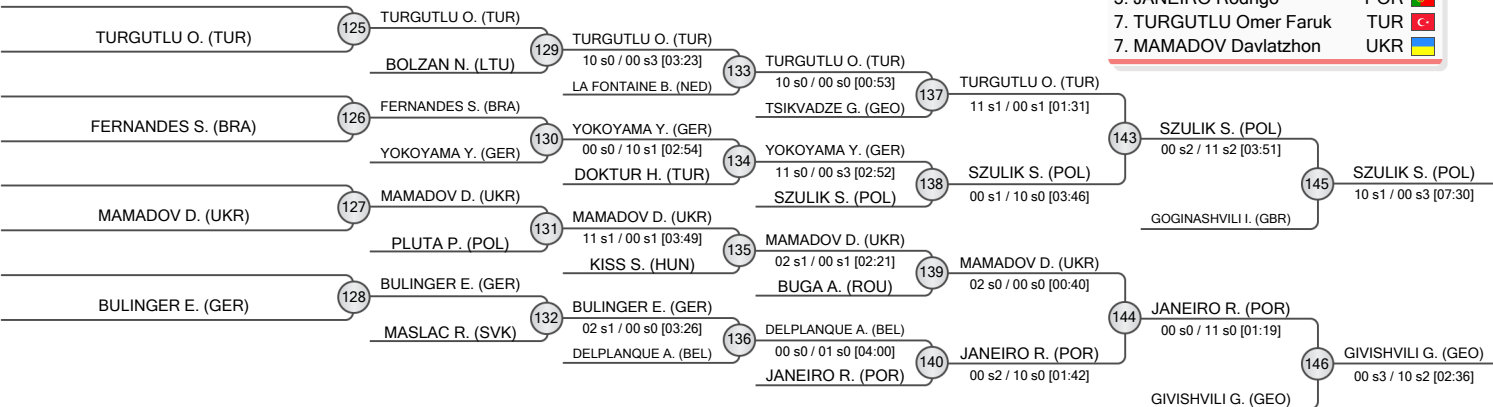



Teplice Cadet European Cup 2023

Czech Republic, Teplice, 8-9 Apr 2023

-66 kg

Men (110)

POOL C

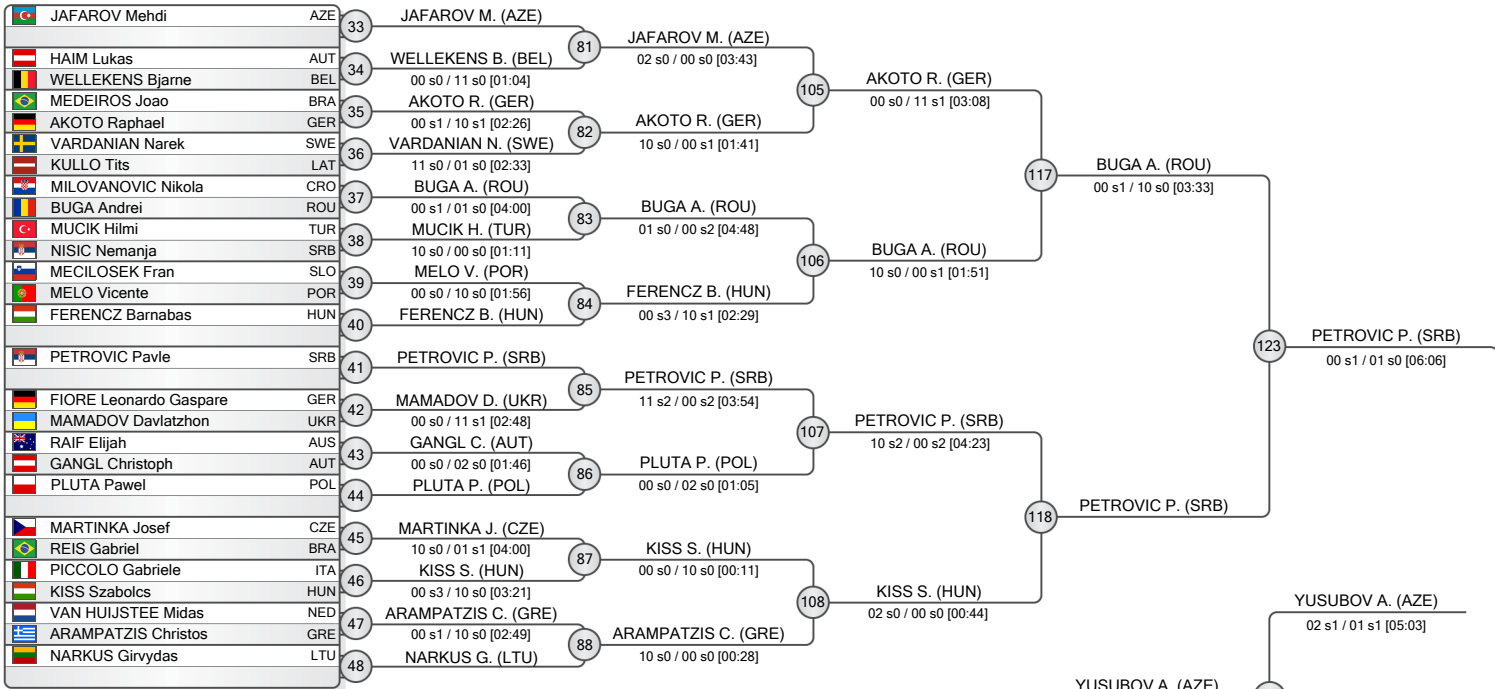

POOL D

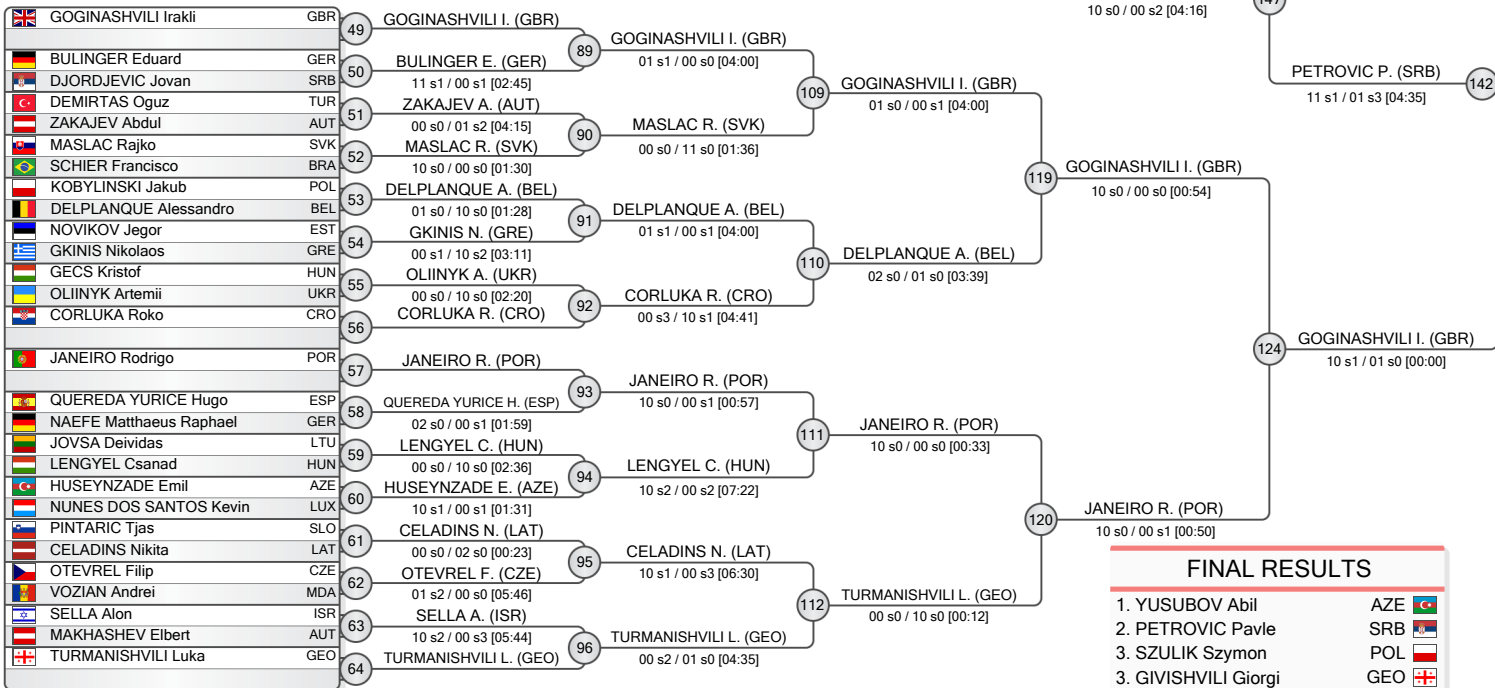

REPECHAGE

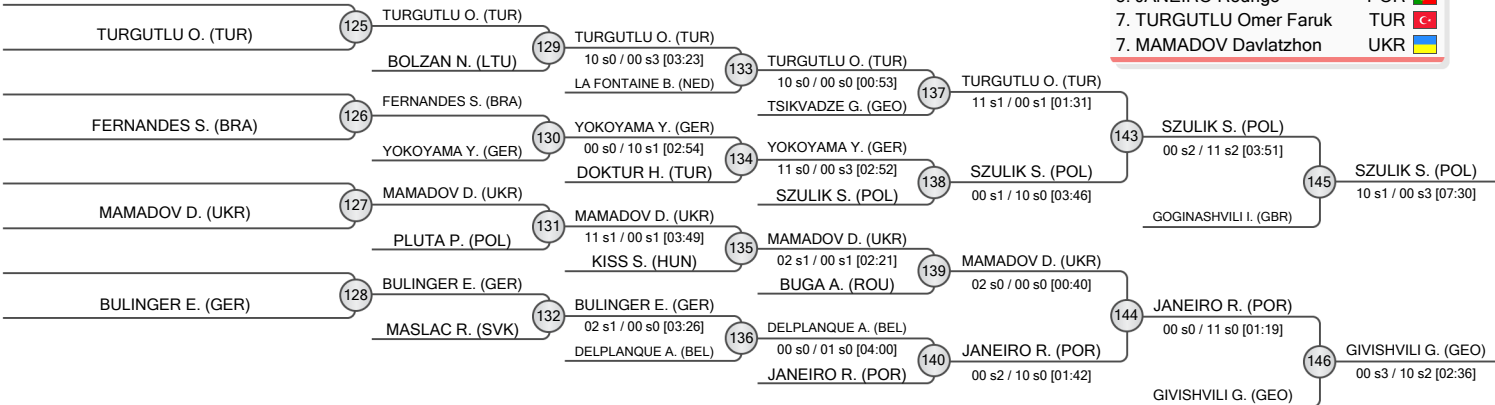

FINAL RESULTS

1. YUSUBOV Abil (AZE) 🇦🇿
2. PETROVIC Pavle (SRB) 🇷🇸
3. SZULIK Szymon (POL) 🇵🇱
4. GIVISHVILI Giorgi (GEO) 🇬🇪
5. GOGINASHVILI Irakli (GBR) 🇬🇧
6. JANEIRO Rodrigo (POR) 🇵🇹
7. TURGUTLU Omer Faruk (TUR) 🇹🇷
8. MAMADOV Davlatzhon (UKR) 🇺🇦





Teplice Cadet European Cup 2023

Czech Republic, Teplice, 8-9 Apr 2023

-73 kg

Men (84)

POOL A

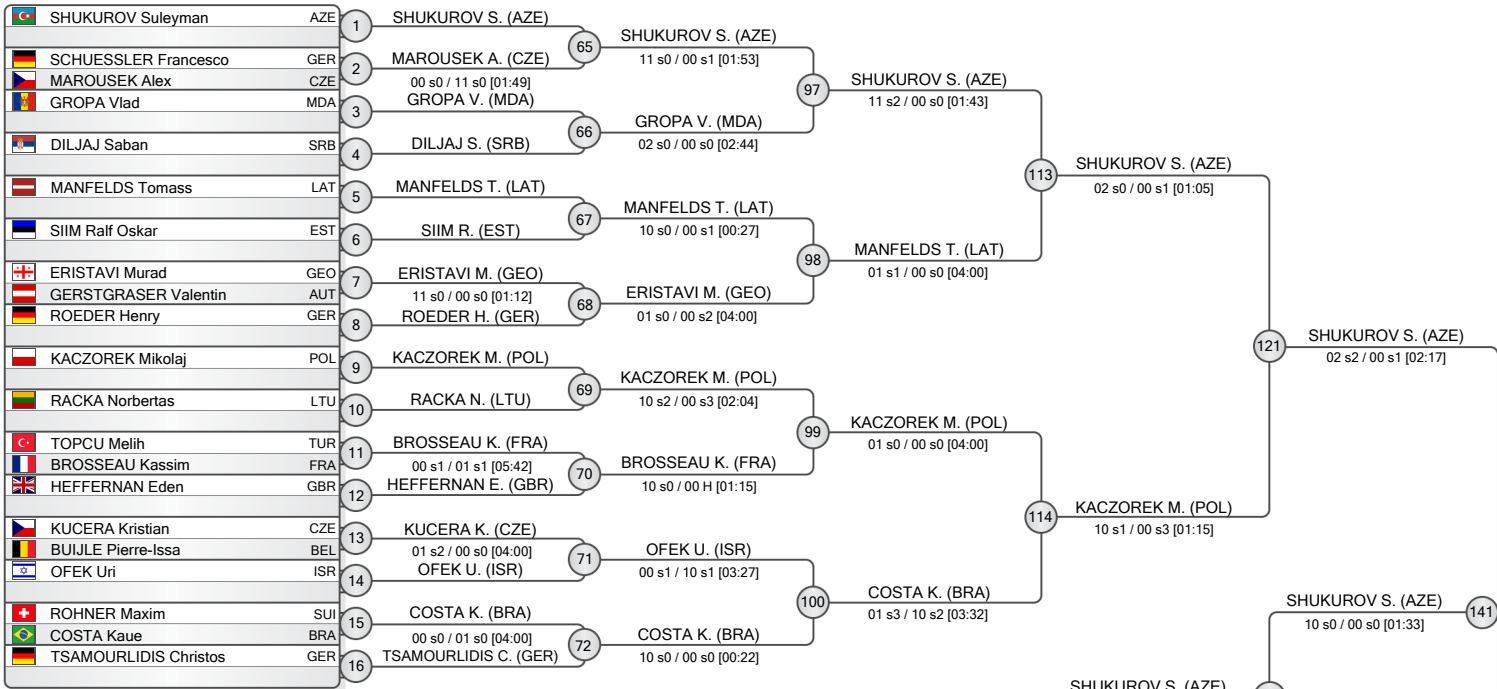

POOL B

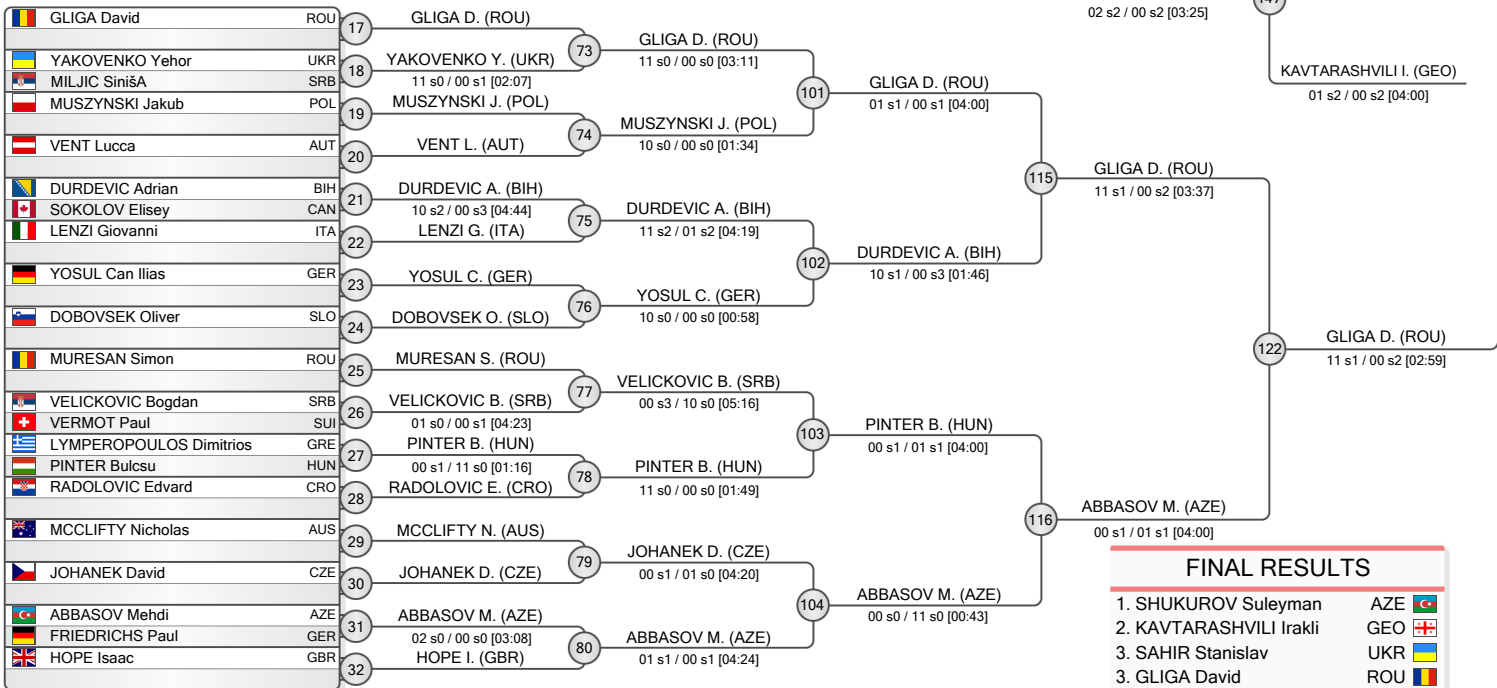

FINAL RESULTS

1. SHUKUROV Suleyman AZE
2. KAVTARASHVILI Irakli GEO
3. SAHIR Stanislav UKR
3. GLIGA David ROU
5. KACZOREK Mikolaj POL
5. SAMADOV Allahverdi AZE
7. ABBASOV Mehdi AZE
7. PROELL Michael AUT

REPECHAGE

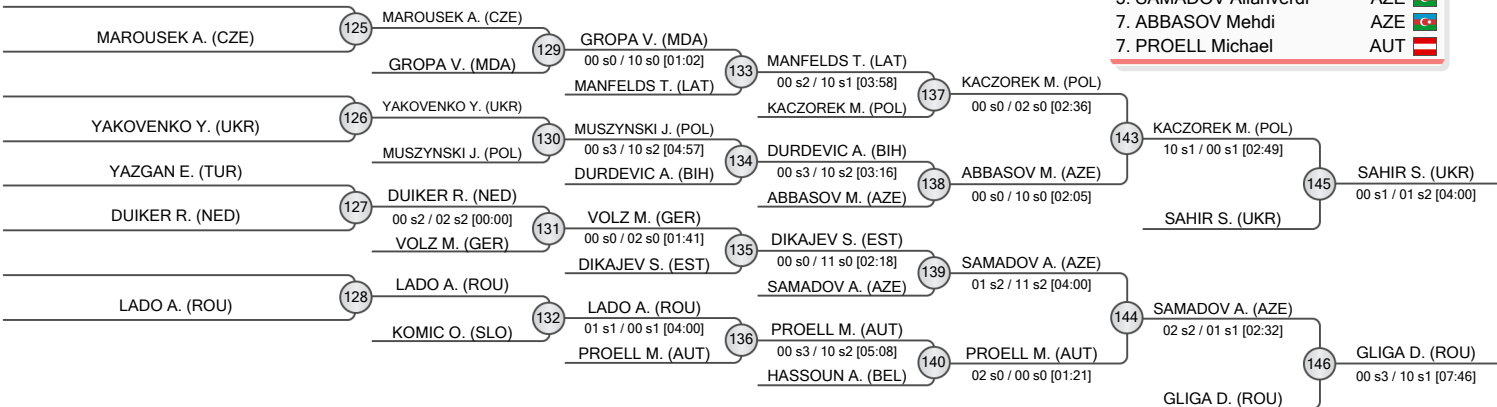



Teplice Cadet European Cup 2023

Czech Republic, Teplice, 8-9 Apr 2023

-73 kg

Men (84)

POOL C

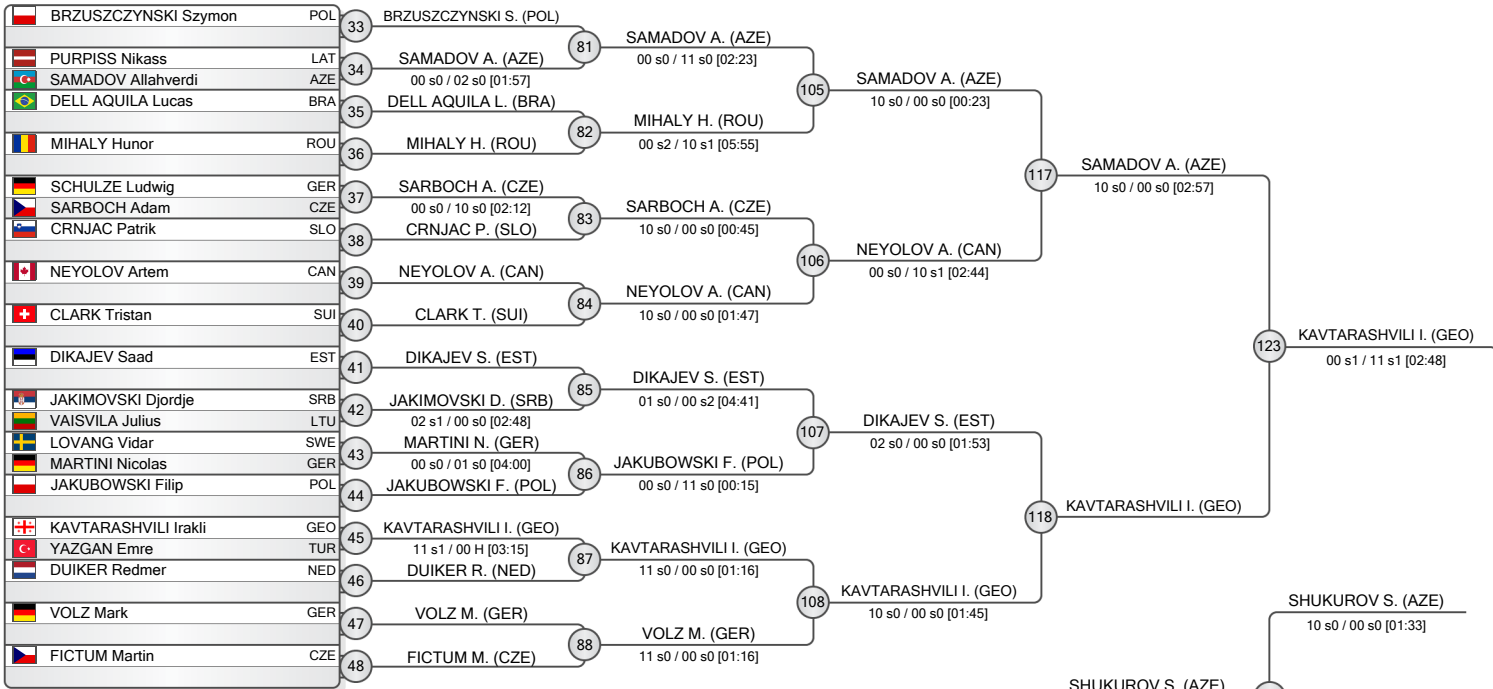

POOL D

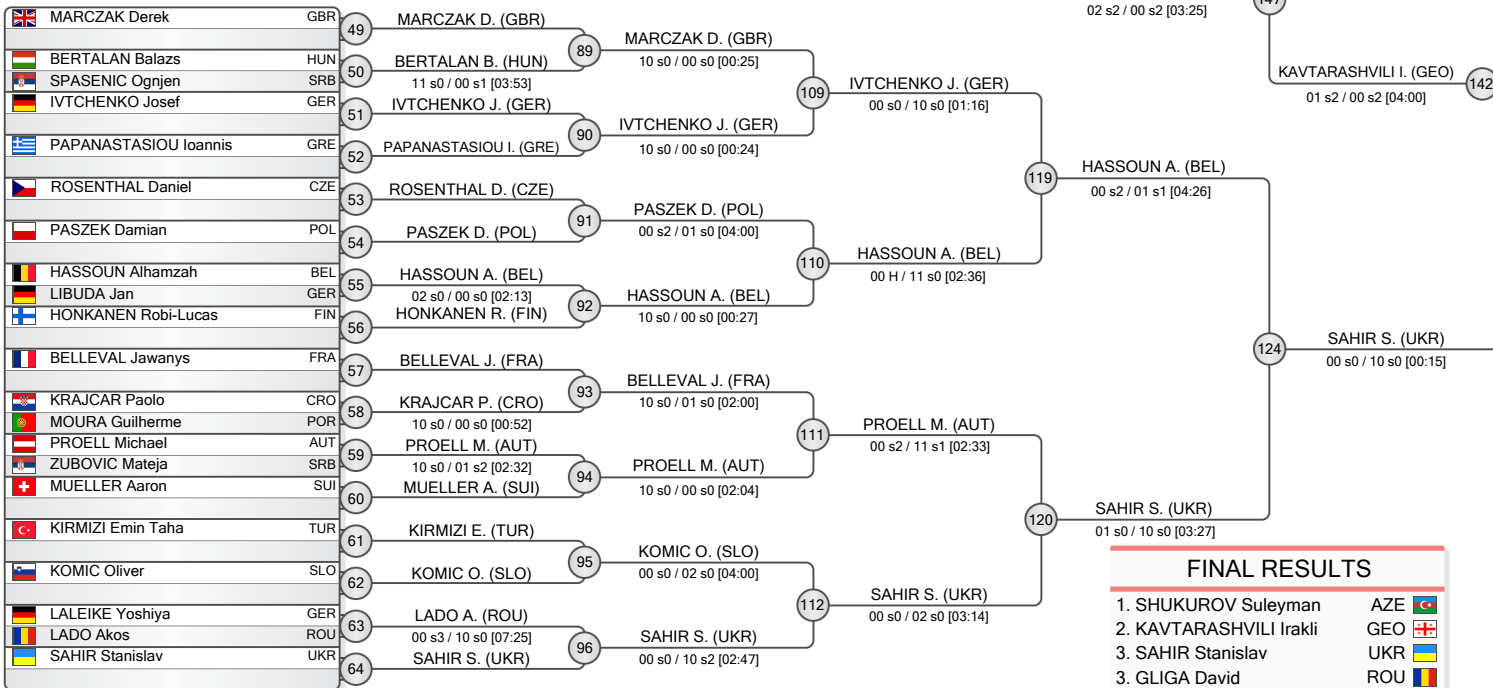

FINAL RESULTS		
1. SHUKUROV Suleyman	AZE	
2. KAVTARASHVILI Irakli	GEO	
3. SAHIR Stanislav	UKR	
3. GLIGA David	ROU	
5. KACZOREK Mikolaj	POL	
5. SAMADOV Allahverdi	AZE	
7. ABBASOV Mehdi	AZE	
7. PROELL Michael	AUT	

REPECHAGE

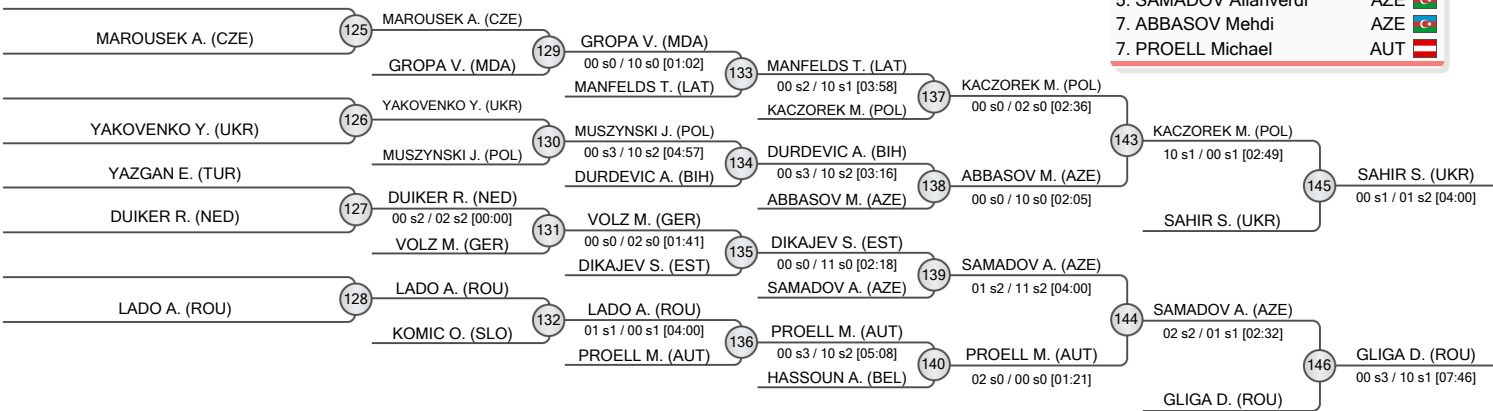



Teplice Cadet European Cup 2023

Czech Republic, Teplice, 8-9 Apr 2023

-81 kg

Men (78)

POOL A

SRB	GRAHOVAC Dusan	1	GRAHOVAC D. (SRB)
POL	KRAUSS Jan	2	POPP A. (GER)
GER	POPP Anton		
SLO	KOS Timotej	3	KOS T. (SLO)
LTU	PETRAUSKAS Majus	4	PETRAUSKAS M. (LTU)
GRE	GEORGIADIS Anestis	5	NAGYVARI Z. (HUN)
HUN	NAGYVARI Zsolt		
CZE	JAKS Adam	6	JAKS A. (CZE)
UKR	KARAKIN Serhii	7	KARAKIN S. (UKR)
TUR	YAZGAN Yunus	8	YAZGAN Y. (TUR)
CRO	BRNADA Ivan	9	BRNADA I. (CRO)
EST	JOLKIN Nikita	10	JOLKIN N. (EST)
SLO	PREDNIK Domen	11	PEREIRA B. (BRA)
BRA	PEREIRA Brenno		
SRB	VUCKOVIC Andrej	12	VUCKOVIC A. (SRB)
AZE	EYVAZLI Huseyn	13	EYVAZLI H. (AZE)
CZE	POTUCEK Tomas	14	POTUCEK T. (CZE)
GEO	BENIADZE Giorgi	15	BAYT V. (FRA)
FRA	BAYT Vitshika		
GER	KUCHARCZYK Quentin	16	KUCHARCZYK Q. (GER)

POOL B

LUX	WELTER Micha	17	WELTER M. (LUX)
SWE	BUJUKLIEV Alex	18	BUJUKLIEV A. (SWE)
SLO	KAVNIK Maj	19	KAVNIK M. (SLO)
ROU	RESMERITA Paul		
LAT	JACENKO Arturs	20	JACENKO A. (LAT)
SRB	DJOKIC Lazar	21	CREMERS K. (BEL)
BEL	CREMERS Kenzo		
UKR	SIDLOVSKYI Mykhailo	22	SIDLOVSKYI M. (UKR)
GER	BISCHOFF Samuel	23	BISCHOFF S. (GER)
HUN	KOVACS Mark	24	KOVACS M. (HUN)
AUS	BEYERS Carstens	25	BEYERS C. (AUS)
MDA	LUPU Vadim	26	PRAUS V. (CZE)
CZE	PRAUS Vitezslav		
GER	PACARIZ Meris	27	PACARIZ M. (GER)
FRA	LE GALLOU Liam	28	LE GALLOU L. (FRA)
LTU	GENEVICIUS Tajus	29	GENEVICIUS T. (LTU)
TUR	KESKIN Berat	30	KESKIN B. (TUR)
BRA	CANELLO Joao Pedro	31	CANELLO J. (BRA)
ISR	CHACHIASHVILI Yehonatan	32	CHACHIASHVILI Y. (ISR)

REPECHAGE

POPP A. (GER)	125	POPP A. (GER)
KOS T. (SLO)	129	KOS T. (SLO)
CREMERS K. (BEL)	126	CREMERS K. (BEL)
SCHWEIGER B. (GER)	127	SCHWEIGER B. (GER)
MARIC M. (SRB)	128	MARIC M. (SRB)

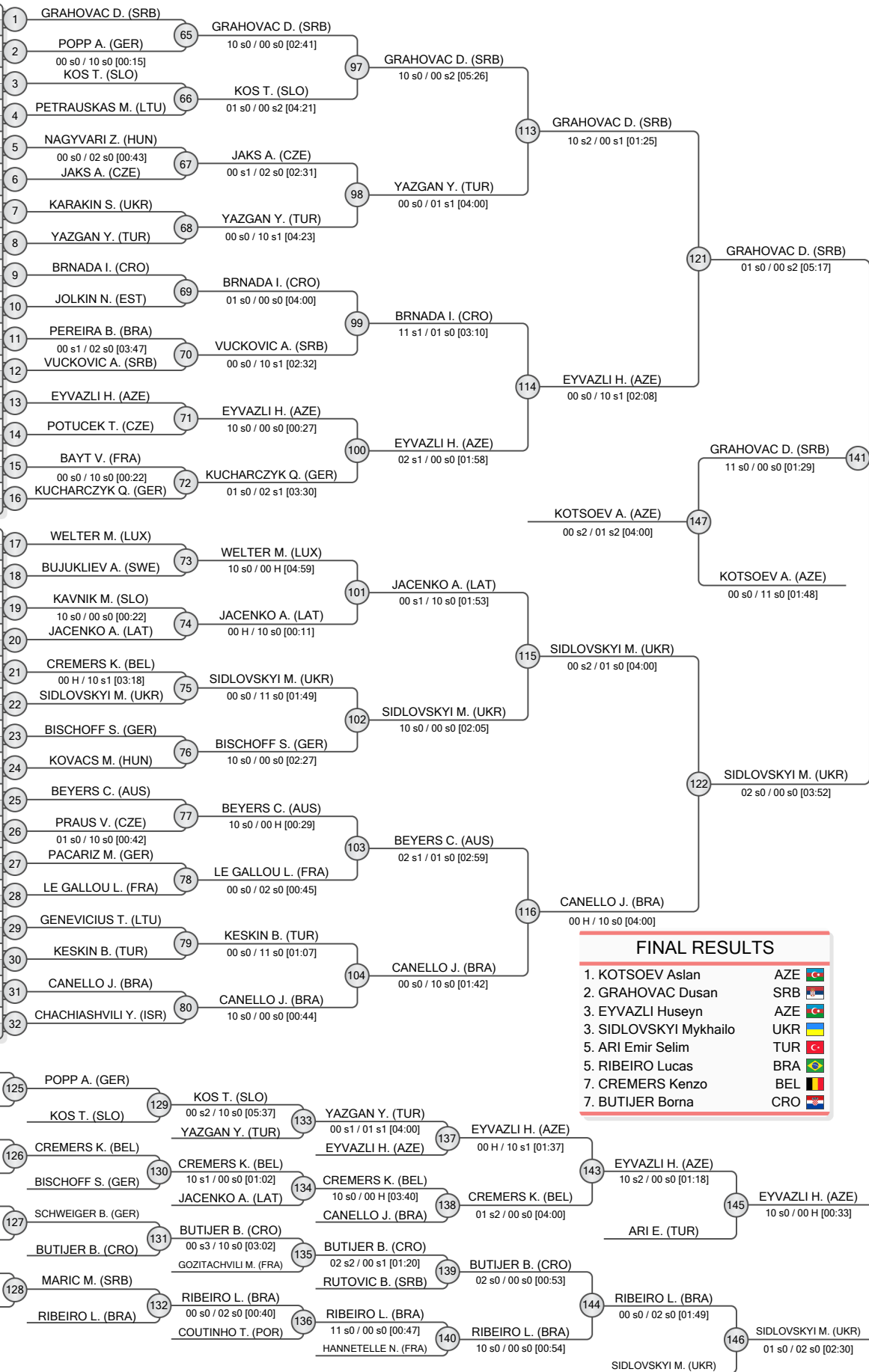

FINAL RESULTS		
1.	KOTSOEV Aslan	AZE
2.	GRAHOVAC Dusan	SRB
3.	EYVAZLI Huseyn	AZE
3.	SIDLOVSKYI Mykhailo	UKR
5.	ARI Emir Selim	TUR
5.	RIBEIRO Lucas	BRA
7.	CREMERS Kenzo	BEL
7.	BUTIJER Borna	CRO





Teplice Cadet European Cup 2023

Czech Republic, Teplice, 8-9 Apr 2023

-81 kg

Men (78)

POOL C

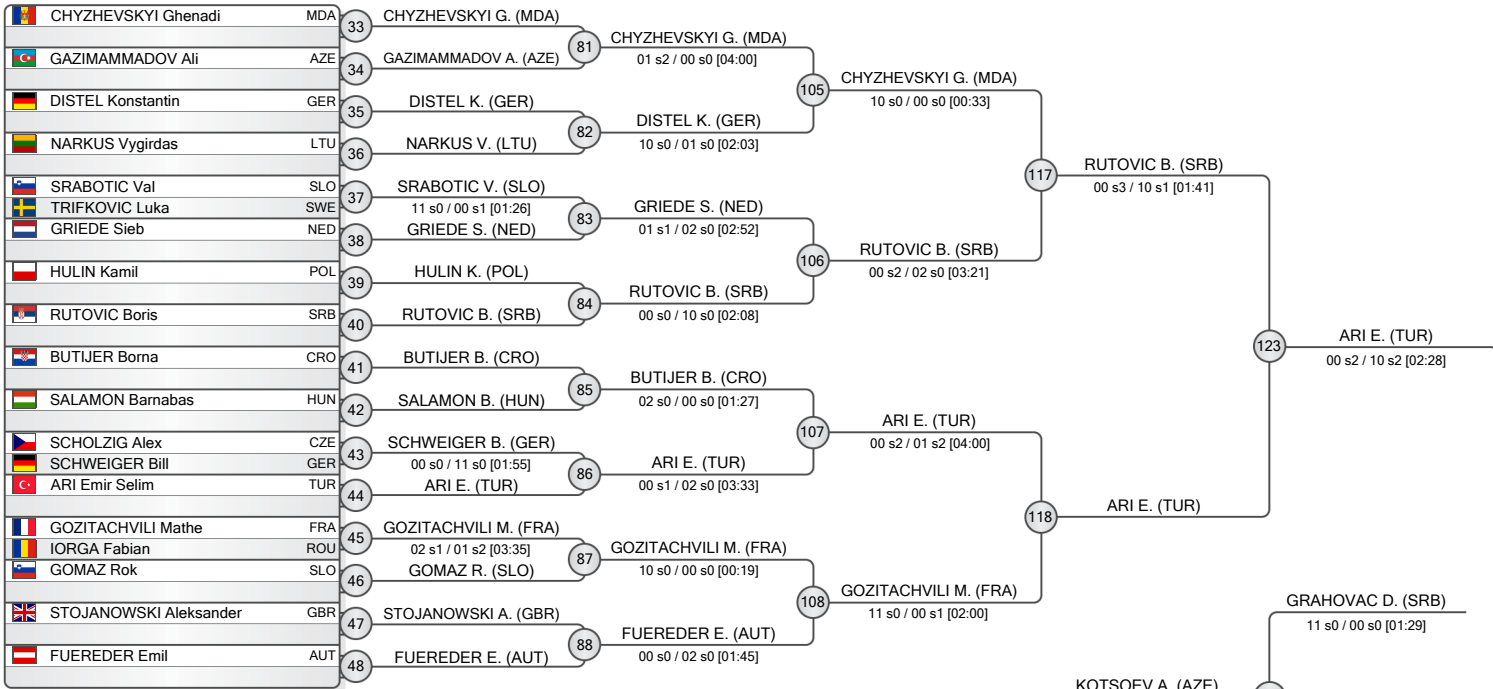

POOL D

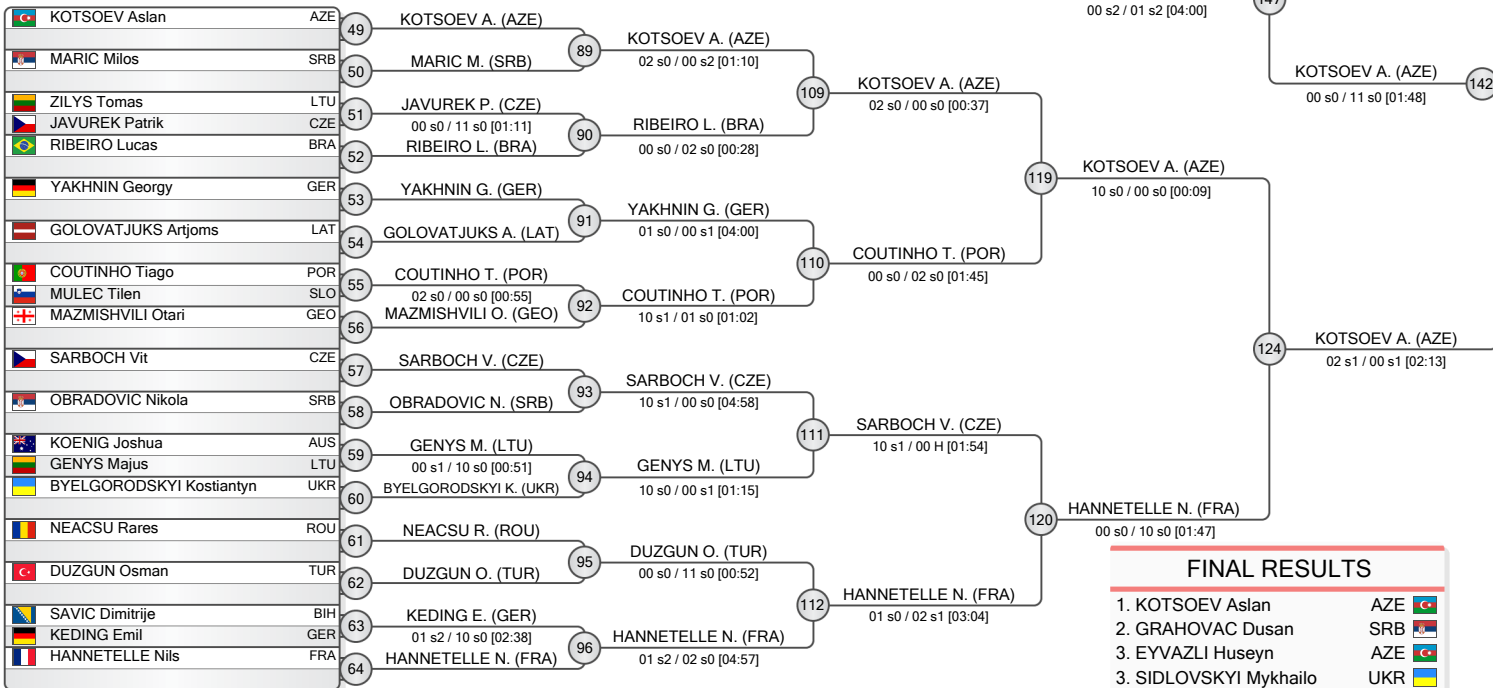

FINAL RESULTS		
1.	KOTSOEV Aslan	AZE
2.	GRAHOVAC Dusan	SRB
3.	EYVAZLI Huseyn	AZE
3.	SIDLOVSKYI Mykhailo	UKR
5.	ARI Emir Selim	TUR
5.	RIBEIRO Lucas	BRA
7.	CREMERS Kenzo	BEL
7.	BUTIJER Borna	CRO

REPECHAGE

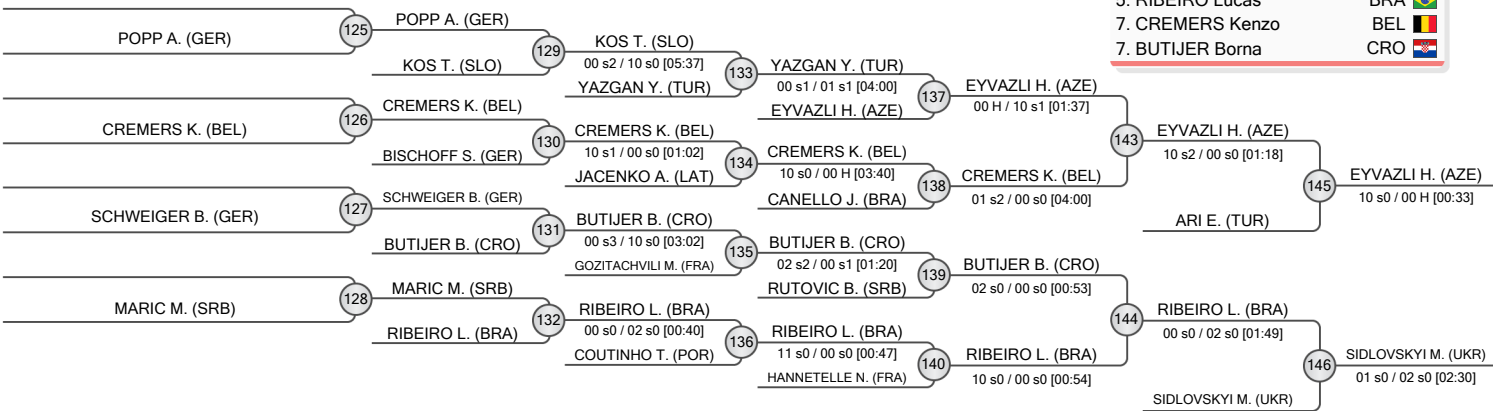



Teplice Cadet European Cup 2023

Czech Republic, Teplice, 8-9 Apr 2023

-90 kg

Men (40)

POOL A

YUDANOV Nikita	UKR	1	YUDANOV N. (UKR)
WACKO Mateusz	POL	2	WACKO M. (POL)
DUR SUN Fatih	TUR	3	DUR SUN F. (TUR)
NGOUMOU David	BEL	4	VARJU V. (HUN)
VARJU Vilmos	HUN	4	VARJU V. (HUN)
LIPIC Gabriel	SLO	5	LIPIC G. (SLO)
JABIYEV Emil	SWE	6	JABIYEV E. (SWE)
USIN Huko PärTel	EST	7	SCHWARZ T. (CZE)
SCHWARZ Tomas	CZE	7	SCHWARZ T. (CZE)
RADOWSKY Carl	GER	8	RADOWSKY C. (GER)

POOL B

BOZIC Marko	CRO	9	BOZIC M. (CRO)
SHAMIL Tuncay	AZE	10	SHAMIL T. (AZE)
KISA Mehmet	TUR	11	CUPALOV J. (LTU)
CUPALOV Jegor	LTU	11	CUPALOV J. (LTU)
PLEVA Jan	CZE	12	PLEVA J. (CZE)
LOZANO PASTOR Guillem	ESP	13	LOZANO PASTOR G. (ESP)
GOLD Denis	GER	14	GOLD D. (GER)
PECHA Matej	SVK	15	CIROVIC N. (SRB)
CIROVIC Nikola	SRB	15	CIROVIC N. (SRB)
HÖFFER Norbert	HUN	16	HOFFER N. (HUN)

POOL C

ALBANO II Alexandre	BRA	17	ALBANO II A. (BRA)
GVAZAVA Nikoloz	GEO	18	GATARIĆ A. (SRB)
GATARIĆ Aleksa	SRB	18	GATARIĆ A. (SRB)
STOROZHUK Danilo	POR	19	STOROZHUK D. (POR)
MENSIK Ondrej	CZE	20	MENSIK O. (CZE)
PARSHYN Viacheslav	UKR	21	PARSHYN V. (UKR)
HODZIC Elmin	AUT	22	RAPKEVICIUS R. (LTU)
RAPKEVICIUS Rokas	LTU	22	RAPKEVICIUS R. (LTU)
MANDIC Kazimir	CRO	23	MANDIC K. (CRO)
DINC Atila	TUR	24	DINC A. (TUR)

POOL D

DINCA Alexandru	ROU	25	DINCA A. (ROU)
SALTONAS Aldas	LTU	26	VAN BILZEM B. (NED)
VAN BILZEM Bas	NED	26	VAN BILZEM B. (NED)
DE LUCA Leandro	GER	27	DE LUCA L. (GER)
KRZYNOWEK Oskar	POL	28	KRZYNOWEK O. (POL)
AFANASJEVS Nikita	LAT	29	AFANASJEVS N. (LAT)
CIRIK Mustafa Enes	TUR	30	CIRIK M. (TUR)
TURI Alex	HUN	31	KUKA B. (KOS)
KUKA Blin	KOS	31	KUKA B. (KOS)
CLOETE Ilan	AUS	32	CLOETE I. (AUS)

REPECHAGE

WACKO M. (POL)	61	WACKO M. (POL)	65	WACKO M. (POL)	69	LIPIC G. (SLO)
PECHA M. (SVK)	62	DUR SUN F. (TUR)	66	PECHA M. (SVK)	70	LIPIC G. (SLO)
HOFFER N. (HUN)	63	PECHA M. (SVK)	67	LOZANO PASTOR G. (ESP)	71	SHAMIL T. (AZE)
GATARIĆ A. (SRB)	64	GATARIĆ A. (SRB)	68	GATARIĆ A. (SRB)	72	SHAMIL T. (AZE)
CIRIK M. (TUR)	65	MENSIK O. (CZE)	69	DINC A. (TUR)	73	DINC A. (TUR)
	66	CIRIK M. (TUR)	70	DINC A. (TUR)	74	DINC A. (TUR)
	67	CLOETE I. (AUS)	71	CIRIK M. (TUR)	75	DINCA A. (ROU)
	68	CLOETE I. (AUS)	72	CLOETE I. (AUS)	76	DINCA A. (ROU)
	69		73	CLOETE I. (AUS)	77	DINCA A. (ROU)
	70		74		78	DINCA A. (ROU)
	71		75		79	DINCA A. (ROU)
	72		76			
	73		77			
	74		78			
	75		79			

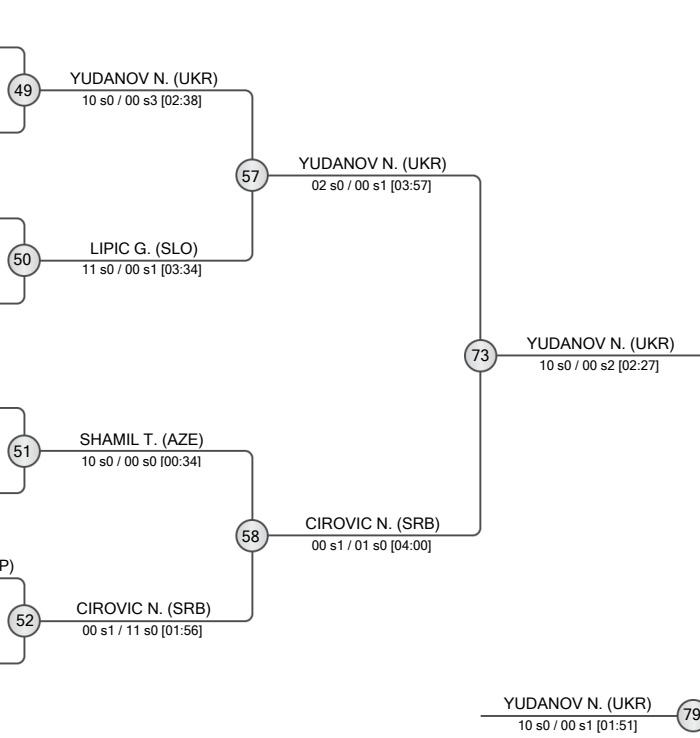

FINAL RESULTS	
1. YUDANOV Nikita	UKR
2. AFANASJEVS Nikita	LAT
3. ALBANO II Alexandre	BRA
3. CIROVIC Nikola	SRB
5. LIPIC Gabriel	SLO
5. DINCA Alexandru	ROU
7. SHAMIL Tuncay	AZE
7. DINC Atila	TUR





Teplice Cadet European Cup 2023

Czech Republic, Teplice, 8-9 Apr 2023

+ 90 kg

Men (30)

POOL A

	SIEWE DJIEKAM Kris Oliver	FRA
	KOCBOGA Ogulcan	TUR
	SCHARNER Oliver	AUT
	SEDLAK Martin	CZE
	REIS Gustavo	BRA
	MATVEEV Alexandr	MDA
	KLIMCIAUSKAS Antanas	LTU

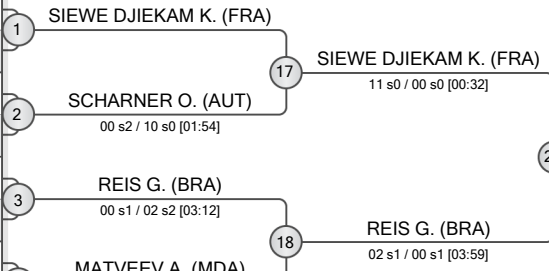

POOL B

	TULSKYKH Mykyta	UKR
	SZEKERES Abel	HUN
	PAULAUSKAS Lukas	LTU
	WILHELM Christian	GER
	KOVINIC Stefan	MNE
	MADEN Mahmutcan	TUR
	SANAMASHVILI Luka	GEO
	DE HAAN Kelvin	NED

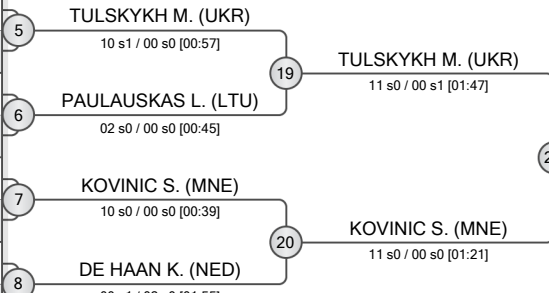

POOL C

	AHMADOV Ramazan	AZE
	KHARAZISHVILI Daviti	GEO
	BANYAMOLI Ozias	BEL
	MĀSAK Marek-Adrian	EST
	GULER Muzaffer	TUR
	STREMAUSKAS Mykolas	LTU
	HROMYKO Nikita	UKR

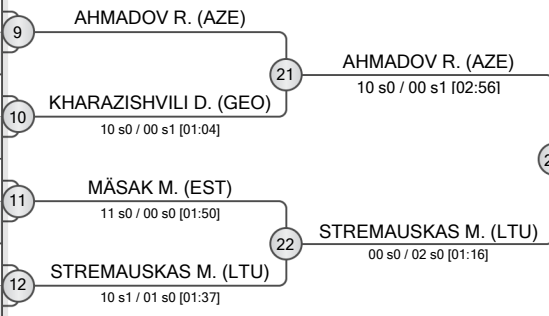

POOL D

	BOROJEVIC Mateja	SRB
	OLIVEIRA Luis Antonio	BRA
	BURES Adam	CZE
	HOFER Julian	AUT
	TOTH Mate	HUN
	ARSLAN Battal Serdar	TUR
	TUGUI David	ROU
	NZUZI DIASIVI Kevin	FRA

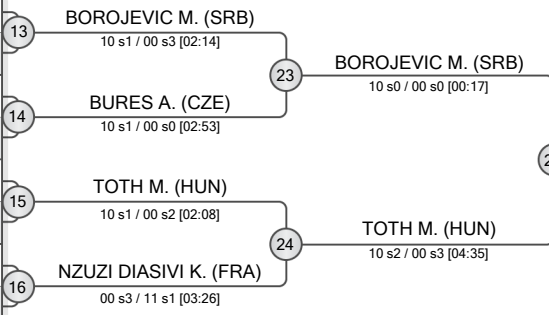

REPECHAGE

29 SCHARNER O. (AUT)	30 DE HAAN K. (NED)	31 KHARAZISHVILI D. (GEO)	32 BURES A. (CZE)
33 REIS G. (BRA)	34 TULSKYKH M. (UKR)	35 KHARAZISHVILI D. (GEO)	36 OLIVEIRA L. (BRA)
37 KOVINIC S. (MNE)	38 AHMADOV R. (AZE)	39 TULSKYKH M. (UKR)	40 KHARAZISHVILI D. (GEO)
41 BOROJEVIC M. (SRB)	42 SIEWE DJIEKAM K. (FRA)		

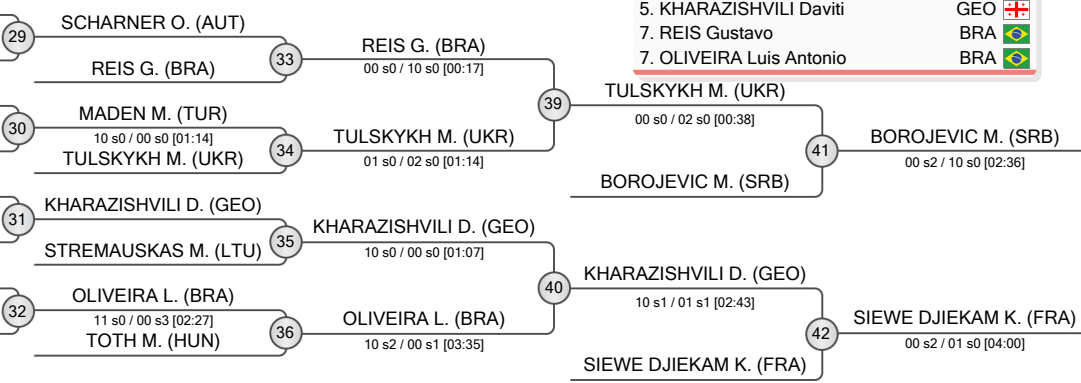

FINAL RESULTS	
1. AHMADOV Ramazan	AZE
2. KOVINIC Stefan	MNE
3. BOROJEVIC Mateja	SRB
3. SIEWE DJIEKAM Kris Oliver	FRA
5. TULSKYKH Mykyta	UKR
7. REIS Gustavo	BRA
7. OLIVEIRA Luis Antonio	BRA





Teplice Cadet European Cup 2023

Czech Republic, Teplice, 8-9 Apr 2023

-40 kg

Women (16)

POOL A

	TOMANKOVA Patricia	SVK
	SPONSELEE Mare	NED
	DUR Sude	TUR
	VRCINAC Milana	SRB

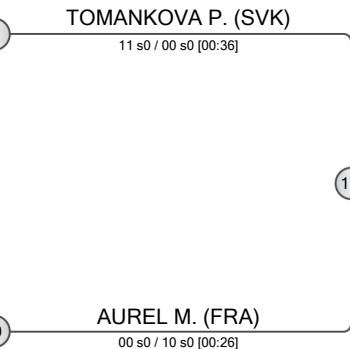
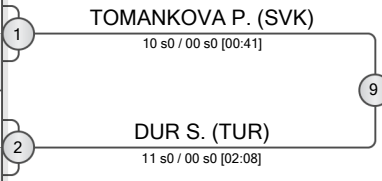

POOL B

	TEMPESTA Miriam	ITA
	HERMAN Rachel	BEL
	AUREL Mathilde	FRA
	CAGLAR Zeynep	TUR

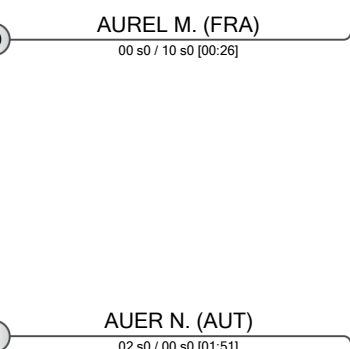
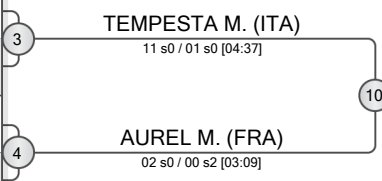

POOL C

	AUER Nina	AUT
	ABDULLAYEVA Khadija	AZE
	VEILLARD Melody	SUI
	ERCIN Rahime	TUR

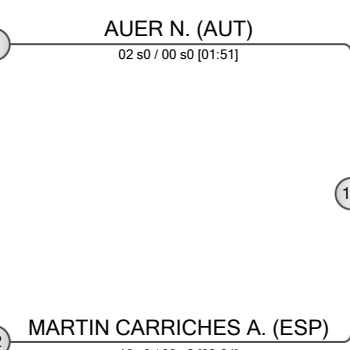
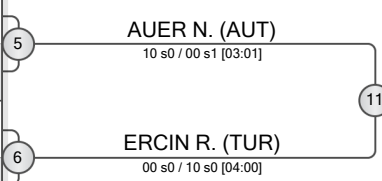

POOL D

	MARTIN CARRICHES Aiora	ESP
	ALMEIDA Ana Luisa	BRA
	CARINHAS Beatriz	POR
	TUNC Merve	TUR

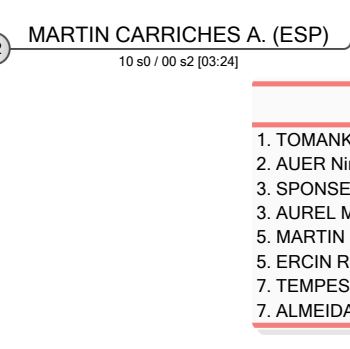
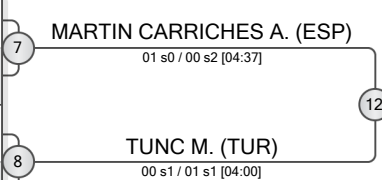

REPECHAGE

SPONSELEE M. (NED)	13	SPONSELEE M. (NED)	02 s0 / 00 s0 [01:28]
DUR S. (TUR)	14	TEMPESTA M. (ITA)	00 s1 / 01 s1 [04:00]
CAGLAR Z. (TUR)	15	ERCIN R. (TUR)	00 s1 / 01 s1 [04:00]
TEMPESTA M. (ITA)	16	ALMEIDA A. (BRA)	00 s1 / 01 s1 [04:00]
ABDULLAYEVA K. (AZE)		TUNC M. (TUR)	00 s1 / 01 s1 [04:00]

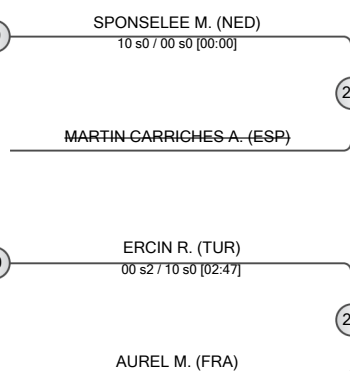
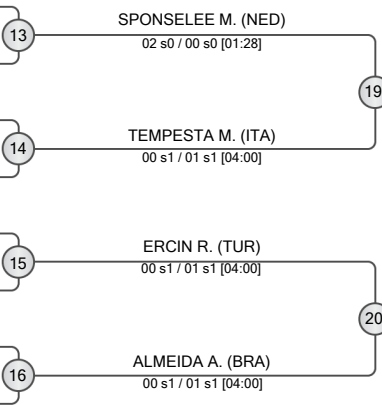

FINAL RESULTS		
1.	TOMANKOVA Patricia	SVK
2.	AUER Nina	AUT
3.	SPONSELEE Mare	NED
3.	AUREL Mathilde	FRA
5.	MARTIN CARRICHES Aiora	ESP
5.	ERCIN Rahime	TUR
7.	TEMPESTA Miriam	ITA
7.	ALMEIDA Ana Luisa	BRA





Teplice Cadet European Cup 2023

Czech Republic, Teplice, 8-9 Apr 2023

-44 kg

Women (27)

POOL A

	BEORLEGUI OSES Marta	ESP
	TUCAJ Martina	CRO
	MENDES Sarah	BRA
	RIKMANSPOEL Maud	NED
	ERDOGMUS Seval	TUR
	ZEIER Lotta	GER
	MOUSSATI Nourane	FRA

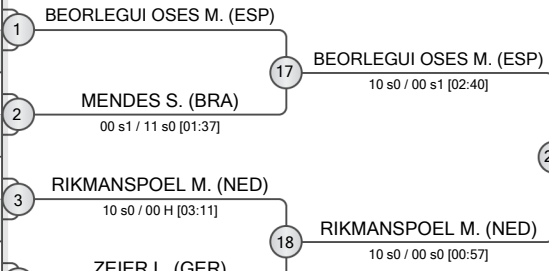

POOL B

	KRIZOVA Kristina Lili	SVK
	FINAZZER Flavia	ITA
	ANTOINE Lena	BEL
	BUSAUSKAITE Migle	LTU
	EROGLU Esmâ Nur	TUR
	KISS Viktoria	HUN

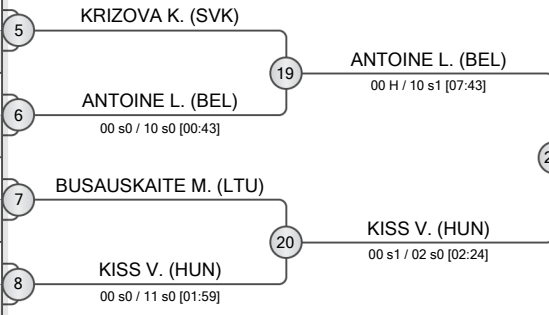

POOL C

	KLEIN Ronja	GER
	BAYRAMZADE Maryam	AZE
	DOGRUYOL Begumnaz	TUR
	MIELIESHKOVA Viola	UKR
	YAMASAKI Juliana	BRA
	CORSI Margot	ITA
	KAZACENKO Evelina	LAT

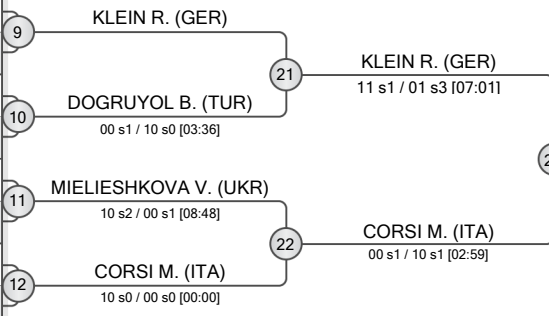

POOL D

	LAHRIFI Lalla-Dounia	FRA
	TOPALSALIHOGU Eda Naz	TUR
	PROLIC Natalija	SRB
	VONDRAKOVA Lada	CZE
	ZOCH Florentine	GER
	VAN BENEDEN Celia	BEL
	SERBAN Denisa	ROU

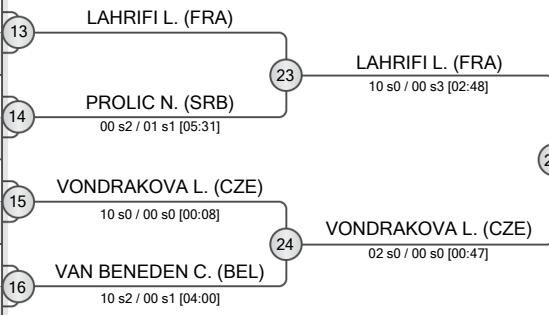

REPECHAGE

29 MENDES S. (BRA)	30 BUSAUSKAITE M. (LTU)	31 DOGRUYOL B. (TUR)	32 VAN BENEDEN C. (BEL)
33 RIKMANSPOEL M. (NED)	34 ANTOINE L. (BEL)	35 DOGRUYOL B. (TUR)	36 ZOCH F. (GER)
39 MENDES S. (BRA)	40 DOGRUYOL B. (TUR)	41 MENDES S. (BRA)	42 BEORLEGUI OSES M. (ESP)

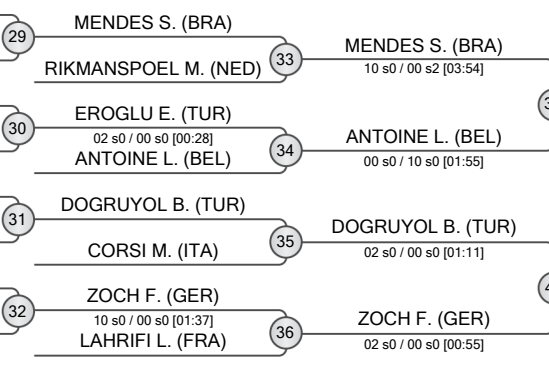

FINAL RESULTS	
1. KLEIN Ronja	GER
2. KISS Viktoria	HUN
3. MENDES Sarah	BRA
3. BEORLEGUI OSES Marta	ESP
5. VONDRAKOVA Lada	CZE
7. ANTOINE Lena	BEL
7. ZOCH Florentine	GER





Teplice Cadet European Cup 2023

Czech Republic, Teplice, 8-9 Apr 2023

-48 kg

Women (50)

POOL A

1	DIAZ HERNANDEZ Aitana ESP	1	DIAZ HERNANDEZ A. (ESP)	33	DIAZ HERNANDEZ A. (ESP)	
2	CALLAGHAN Jocelyn GBR	2	MONNEY L. (SUI)	00 s0 / 01 s0 [04:26]	10 s0 / 00 s0 [01:30]	
3	MONNEY Lya SUI	3	IDDIR C. (FRA)	00 s0 / 10 s1 [02:16]		
4	SHCHUR Sofiia UKR	4	JOVANOVIC A. (SRB)	00 s0 / 10 s0 [01:13]	34	JOVANOVIC A. (SRB)
5	IDDIR Celine FRA	5	STOFBERG L. (NED)			
6	LANDRICHINGER Emma AUT	6	DINCER G. (TUR)	00 s0 / 10 s0 [06:40]	35	DINCER G. (TUR)
7	JOVANOVIC Anja SRB	7	MOHAROS Z. (HUN)	11 s0 / 00 s2 [02:29]	36	MOHAROS Z. (HUN)
8	STOFBERG Lara NED	8	CZERWIŃSKA -KOWAR R. (POL)	10 s0 / 00 H [05:05]		

POOL B

9	MAILLARD Celia FRA	9	MAILLARD C. (FRA)	37	MAILLARD C. (FRA)	
10	BUYUK Sena Nur TUR	10	RODRIGUES N. (BRA)	00 H / 10 s0 [02:34]	01 s2 / 00 s0 [04:00]	
11	RODRIGUES Nicole BRA	11	ERTEN K. (GER)	00 s0 / 10 s0 [01:18]	38	ERTEN K. (GER)
12	STEVANOVIC Milana MNE	12	ANELLI S. (ITA)			
13	ERTEN Klara GER	13	HAJIYEVA V. (AZE)	10 s0 / 00 s2 [03:53]	39	HAJIYEVA V. (AZE)
14	ANELLI Simona ITA	14	NONA C. (GRE)	00 s1 / 02 s1 [02:18]	40	SCHOONEN L. (NED)
15	HAJIYEVA Vusala AZE	15	NETTESHEIM C. (GER)	00 s0 / 11 s0 [00:48]		
16	BARYSHEVSKA Dariia UKR	16	SCHOONEN L. (NED)	00 s2 / 01 s0 [04:00]		
17	NONA Christina-Magdalini GRE					
18	CARRACA Maria SUI					
19	NETTESHEIM Charlotte GER					
20	SCHOONEN Liv NED					

POOL C

17	JUTTNER Janka HUN	17	JUTTNER J. (HUN)	41	JUTTNER J. (HUN)	
18	RIDDERSKAMP Helke GER	18	CARNEIRO N. (BRA)	00 s3 / 10 s2 [04:29]	42	FROSZTEGA I. (POL)
19	CARNEIRO Nycolly BRA	19	MIRZAYEVA F. (AZE)	02 s0 / 00 s1 [01:04]		
20	MIRZAYEVA Farida AZE	20	FROSZTEGA I. (POL)	00 s0 / 02 s0 [01:15]		
21	MARKOU Maria Eleni GRE	21	MINASYAN T. (AUT)			
22	TOURNIER Maelie AUS	22	MERCEA C. (ROU)	00 s1 / 11 s1 [01:55]	43	MERCEA C. (ROU)
23	FROSZTEGA Iga POL	23	KAYA M. (TUR)	02 s0 / 00 s1 [02:38]	44	KAYA M. (TUR)
24	MINASYAN Tatevik AUT	24	PAUCHENKO V. (UKR)	00 s3 / 10 s2 [03:25]		
25	MERCEA Cristiana ROU					
26	KRUTSCH Laura GER					
27	MILHAVET Agathe FRA					
28	KAYA Merve TUR					
29	PAUCHENKO Viktoriia UKR					

POOL D

25	AYMARD Tifenn FRA	25	AYMARD T. (FRA)	45	STORM S. (GER)	
26	STORM Sophia Grace GER	26	STORM S. (GER)	10 s0 / 00 s0 [02:25]	46	ALDER A. (GBR)
27	HOEKSTRA Robin NED	27	RODRIGUES J. (BRA)	00 s1 / 11 s1 [03:26]		
28	BILBA Victoria MDA	28	ALDER A. (GBR)	00 s0 / 02 s0 [02:00]		
29	RODRIGUES Julia BRA	29	SZABO R. (HUN)	02 s0 / 00 s2 [03:45]	47	SZABO R. (HUN)
30	ALDER Amelia GBR	30	CARRACA C. (SUI)	00 s0 / 10 s0 [01:33]	48	FISCHER C. (GER)
31	SZABO Reka HUN	31	TWAROWSKA B. (POL)	01 s1 / 10 s1 [03:43]		
32	HENRIQUES Iara POR	32	FISCHER C. (GER)	10 s0 / 00 s1 [01:00]		
33	CARRACA Celina SUI					
34	SAHBAL Sila TUR					
35	TWAROWSKA Barbara POL					
36	FISCHER Christina GER					

REPECHAGE

61	MONNEY L. (SUI)	61	MONNEY L. (SUI)	65	JOVANOVIC A. (SRB)
62	NONA C. (GRE)	62	SCHOONEN L. (NED)	66	SCHOONEN L. (NED)
63	CARNEIRO N. (BRA)	63	CARNEIRO N. (BRA)	67	CARNEIRO N. (BRA)
64	FISCHER C. (GER)	64	SAHBAL S. (TUR)	68	SAHBAL S. (TUR)
65	JOVANOVIC A. (SRB)	65	SAHBAL S. (TUR)		
66	SCHOONEN L. (NED)	66	SZABO R. (HUN)		
67	CARNEIRO N. (BRA)	67	ALDER A. (GBR)		
68	SAHBAL S. (TUR)	68	ALDER A. (GBR)		

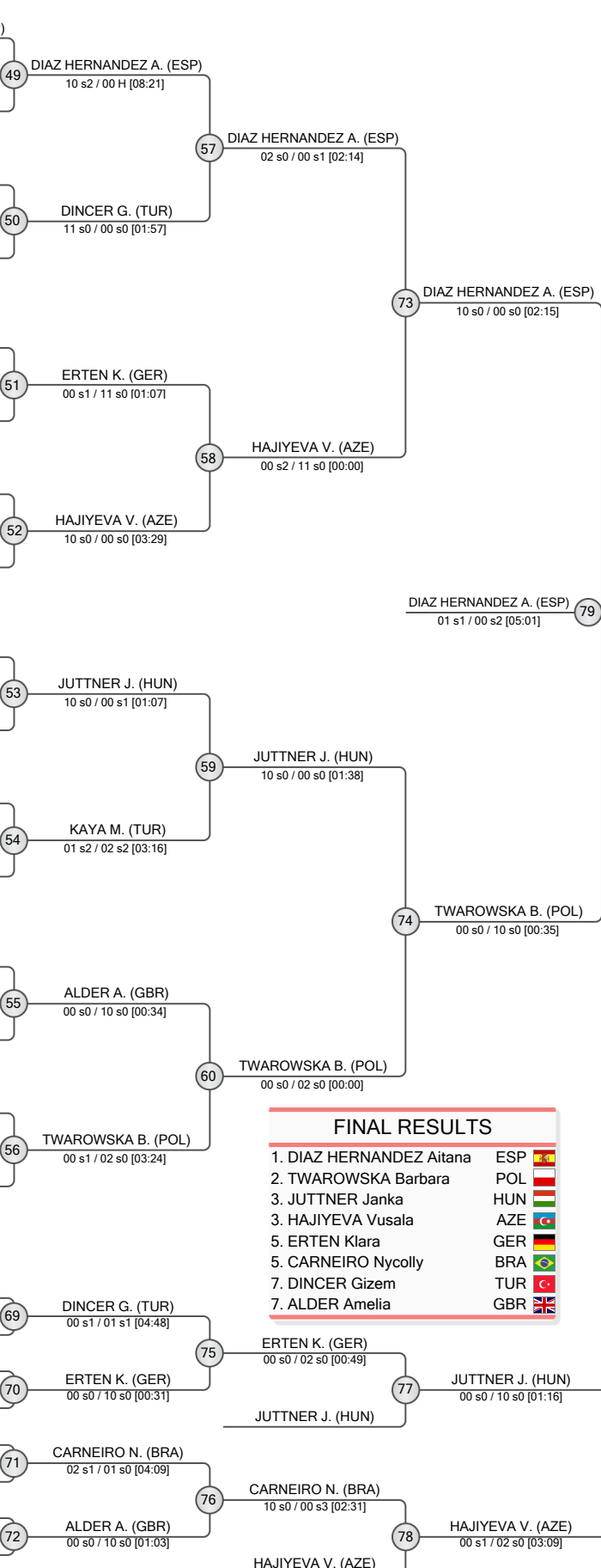



Teplice Cadet European Cup 2023

Czech Republic, Teplice, 8-9 Apr 2023

-52 kg

Women (73)

POOL C

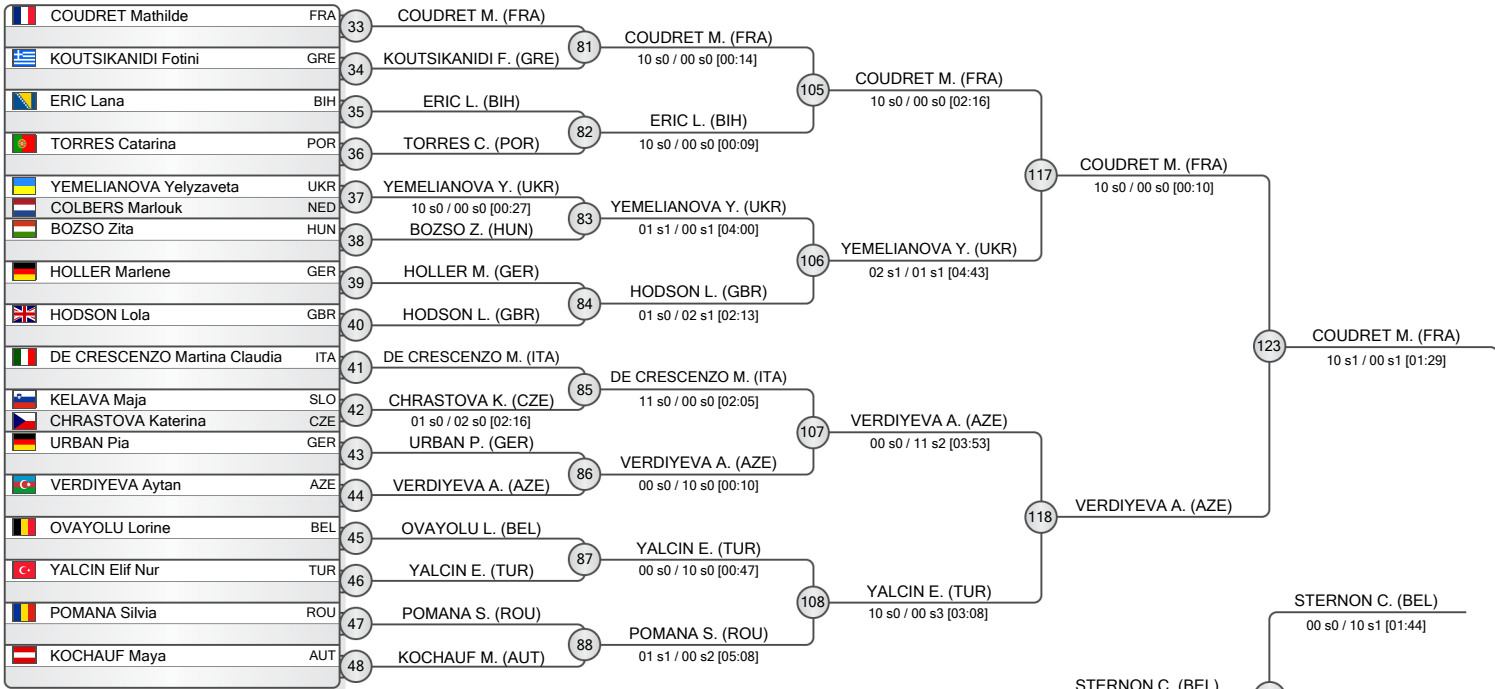

POOL D

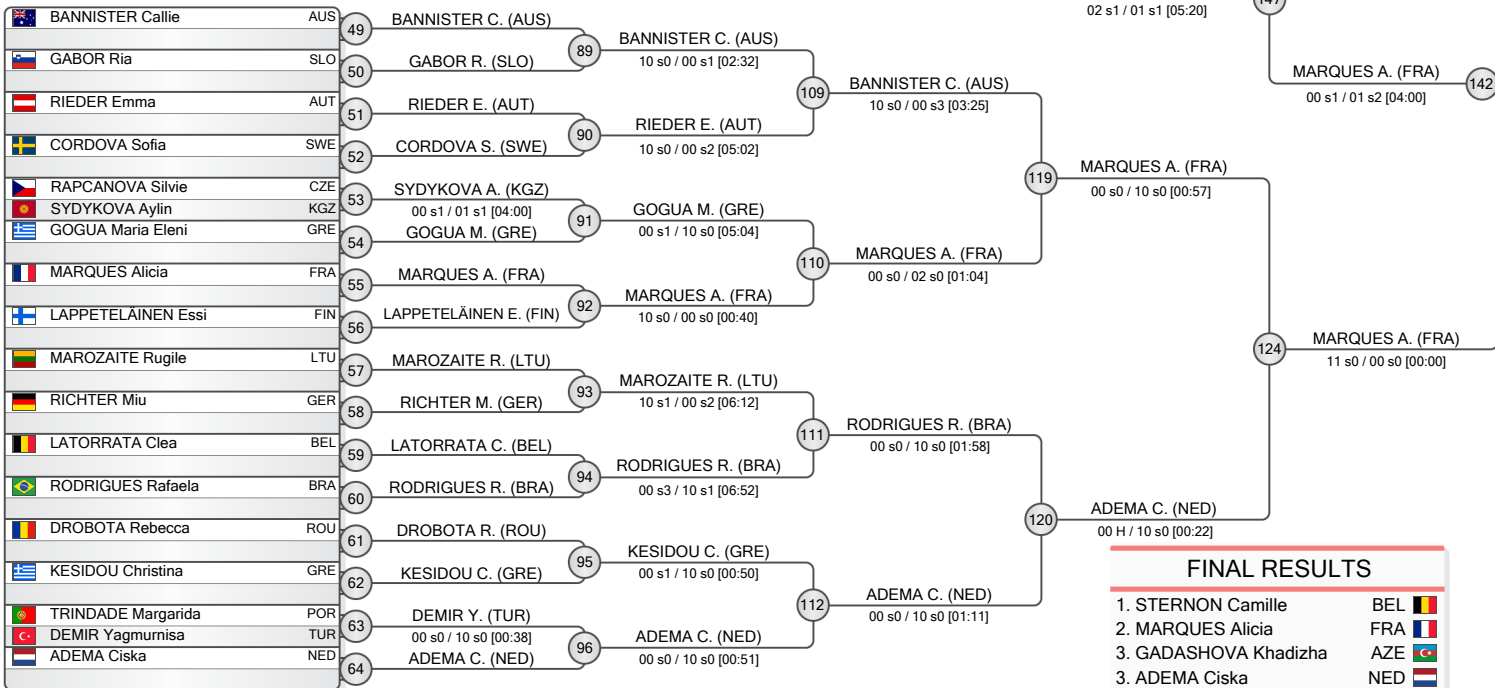

FINAL RESULTS	
1. STERNON Camille	BEL 🇧🇪
2. MARQUES Alicia	FRA 🇫🇷
3. GADASHOVA Khadzisha	AZE 🇦🇿
3. ADEMA Ciska	NED 🇳🇱
5. COUDRET Mathilde	FRA 🇫🇷
5. TOSZEGI Maya	GER 🇩🇪
7. GACIC Mina	SRB 🇷🇸
7. VERDIYEVA Aytan	AZE 🇦🇿

REPECHAGE

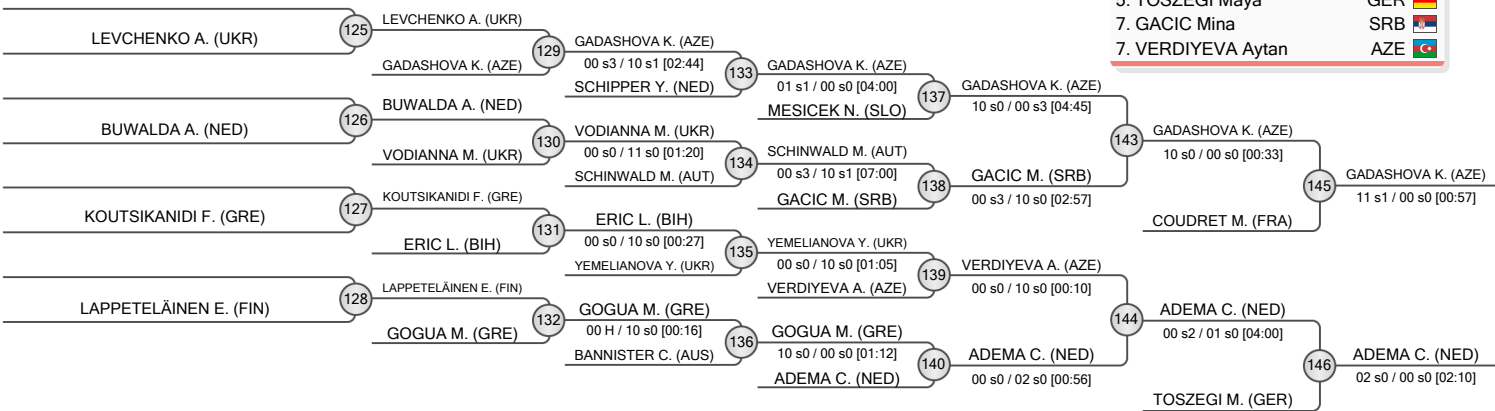



Teplice Cadet European Cup 2023

Czech Republic, Teplice, 8-9 Apr 2023

-57 kg

Women (59)

POOL A

1	SILVEIRA Maria	POR
2	KALETOVA Magdalena	CZE
3	KAYA Zehranur	TUR
4	TKACHENKO Alyssa	CAN
5	KREIDIN Irina	GER
6	GADZIC Natasa	SRB
7	BAZSANYI Dorka	HUN
8	GERETZKI Vanessa	GER
9	DESCHEPPER AiCha	BEL
10	BEAUQUEY Lola	FRA
11	VEINHANDL OBAID Haya	SLO
12	EIFERT Sophie	GER
13	GASIMOVA Fidan	AZE
14	SINNEMA Fleur	NED
15	CESLAUSKAITE Deimante	LTU

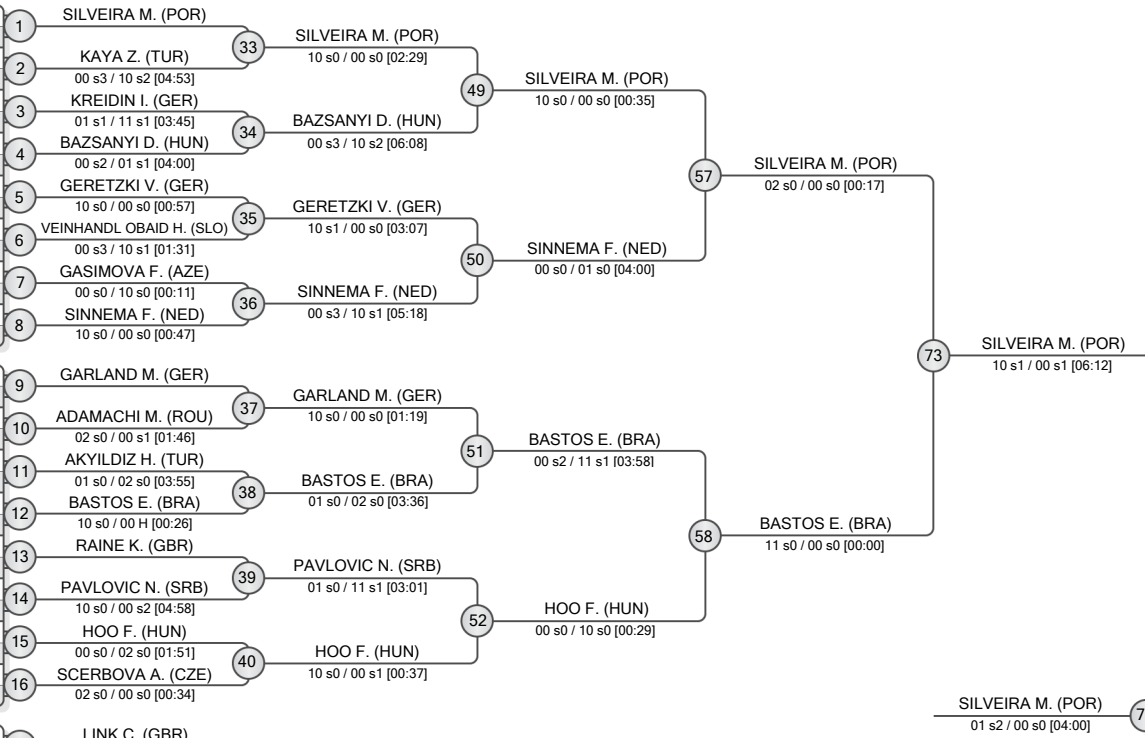

POOL B

9	GARLAND Marley	GER
10	ADAMACHI Maya	ROU
11	WURTH Nadine	AUT
12	IDDIR Feroudja	FRA
13	AKYILDIZ Hilal	TUR
14	BASTOS Eduarda	BRA
15	DZIOB Wiktoria	POL
16	RAINE Kenady	GBR
17	PAVLOVIC Nevena	SRB
18	THOLE Eva	NED
19	BOELCSKEI Hanna	GER
20	HOO Fedra	HUN
21	SCERBOVA Amalie	CZE
22	SOTNYK Viktoriia	UKR

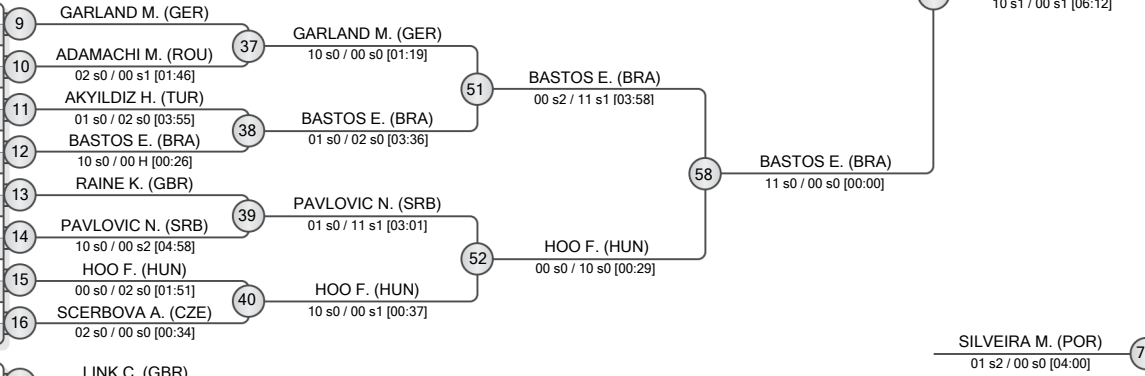

POOL C

17	LINK Chloe	GBR
18	DINIS Laura	POR
19	SEMOUD Luna	GER
20	KOCJAN Neza	SLO
21	KRAEHENBUEHL Emilie	SUI
22	VLKOVA Eliska	CZE
23	KWAPIS Kinga	POL
24	TANDEAN Bianca	AUS
25	SUTOVIC Andrijana	MNE
26	HESSE Chantal	GER
27	KILICKAYA Rumeysa Hatice	TUR
28	SKERYTE Ugne	LTU
29	MARKOVA Jana	CZE
30	KERGALVE Viktorija	LAT
31	DRABIK Zsafia	HUN

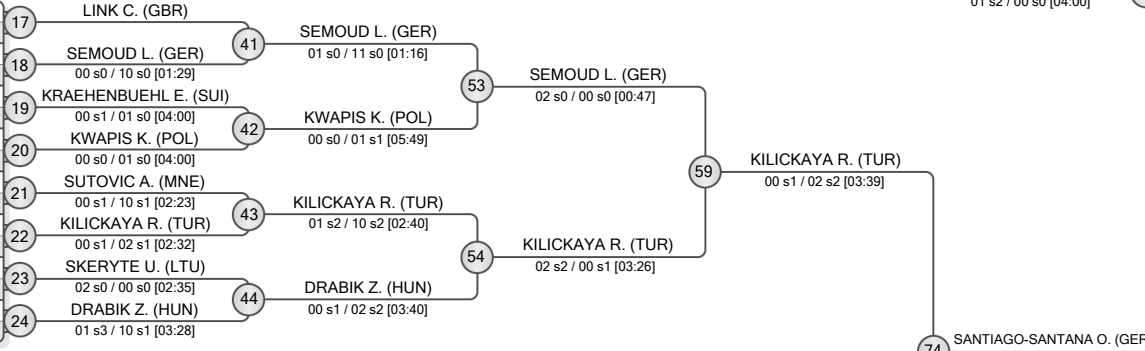

POOL D

25	NICOLAS Ielena	FRA
26	PAEFGEN Janne	GER
27	PANNEGIETER Kaya	NED
28	POZNANOVIĆ Ekaterina	SRB
29	FRADE Victoria	BRA
30	KOLAKOWSKA Zuzanna	POL
31	HERMANOVA Karolina	CZE
32	SANTIAGO-SANTANA Odalis	GER
33	SORELLI Giulia	ITA
34	CHRISAKI Anni-Iris	GRE
35	KISSENISKY Maddy	GBR
36	GAJIC Jevgenija	SLO
37	SCHLIEPER Carlotta	GER
38	AVDIC Leila	SWE
39	YESILYURT Deniz	TUR

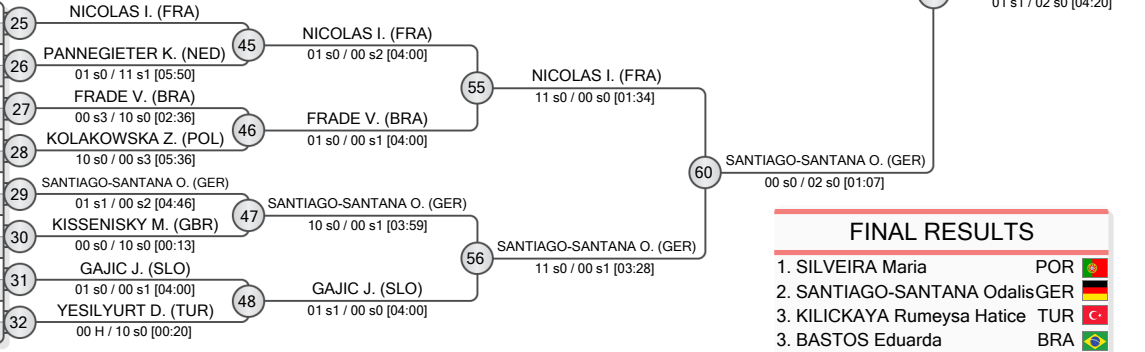

FINAL RESULTS	
1.	SILVEIRA Maria POR
2.	SANTIAGO-SANTANA Odalis GER
3.	KILICKAYA Rumeysa Hatice TUR
3.	BASTOS Eduarda BRA
5.	HOO Fedra HUN
5.	NICOLAS Ielena FRA
7.	SINNEMA Fleur NED
7.	SEMOUD Luna GER

REPECHAGE

61	KAYA Z. (TUR)
62	AKYILDIZ H. (TUR)
63	HESSE C. (GER)
64	KISSENISKY M. (GBR)
65	BAZSANYI D. (HUN)
66	GARLAND M. (GER)
67	DRABIK Z. (HUN)
68	GAJIC J. (SLO)
69	SINNEMA F. (NED)
70	HOO F. (HUN)
71	SEMOUD L. (GER)
72	NICOLAS I. (FRA)
73	SILVEIRA M. (POR)
74	SANTIAGO-SANTANA O. (GER)
75	HOO F. (HUN)
76	NICOLAS I. (FRA)
77	KILICKAYA R. (TUR)
78	BASTOS E. (BRA)

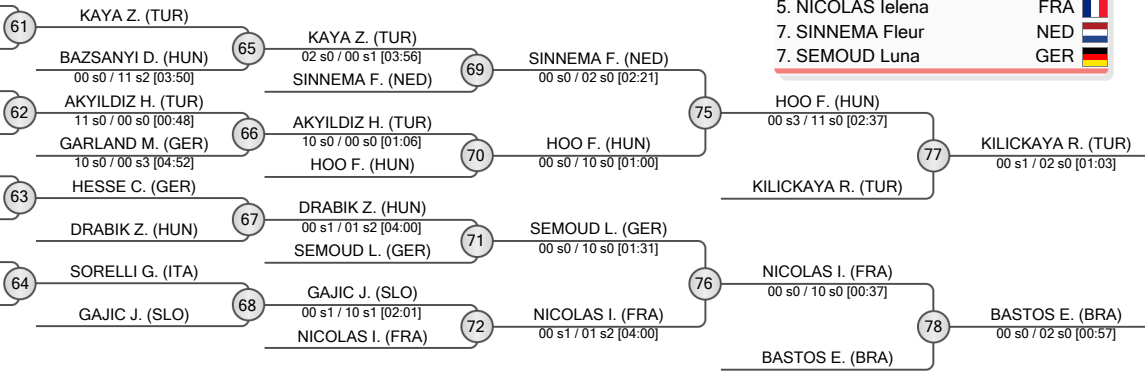



Teplice Cadet European Cup 2023

Czech Republic, Teplice, 8-9 Apr 2023

-63 kg

Women (74)

POOL A

TUR	1	ORUC S. (TUR)
GBR	2	AUBERT GOMEZ M. (GBR)
SLO	3	DEMARCO A. (BRA)
BRA	3	DEMARCO Ana Clara
GER	4	WINTER L. (GER)
NED	5	HANGYI Eva
FRA	5	DALMASSO Madeleine
POL	6	GLUBIAK Magda
HUN	7	SARKOZI Zsuzsa
UKR	8	OPANASENKO Kristina
SRB	9	SADIKU Dunja
LTU	10	STEPONAVICIUTE Austeja
SLO	10	KELAVA Dunja
ROU	11	BOB Isabel
GER	12	HOHMANN Rabea
AUT	13	PROELL Claire
CZE	14	SADILKOVA Zuzana
SUI	15	PROBST Eileen
GRE	16	TAXIDOU Eleni

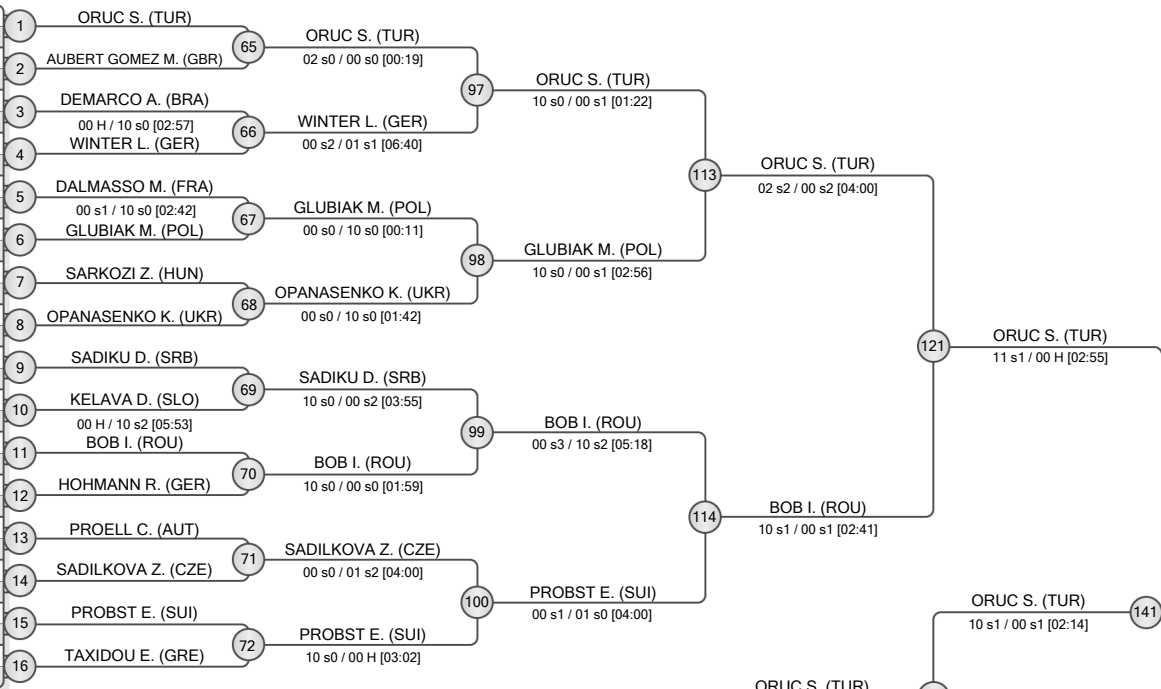

POOL B

NED	17	DE KOCK Luna
AUT	18	BETZ Lisa
BEL	19	BEETERENS Hanne
ITA	20	D ALESSANDRO Erica
SUI	21	HALBHEER Svenja
UKR	22	KARPUKHOVA Anhelina
FIN	23	KUOSMANEN Jenna
LAT	23	ISAJEVA Anastasija
GER	24	STEINEBRUNNER Salome
CRO	25	CVJETKO Jana
SLO	26	SIKOSEK Ajda
CZE	27	VAVRINOVA Pavla
SWE	27	ALENBACK Alma
SRB	28	DJORDJEVIC Kristina
GRE	29	KARASTRATIDOU Eleni
TUR	30	KARA Sumeyra
GER	31	LISTL Emma
FRA	32	MBAYE Lea

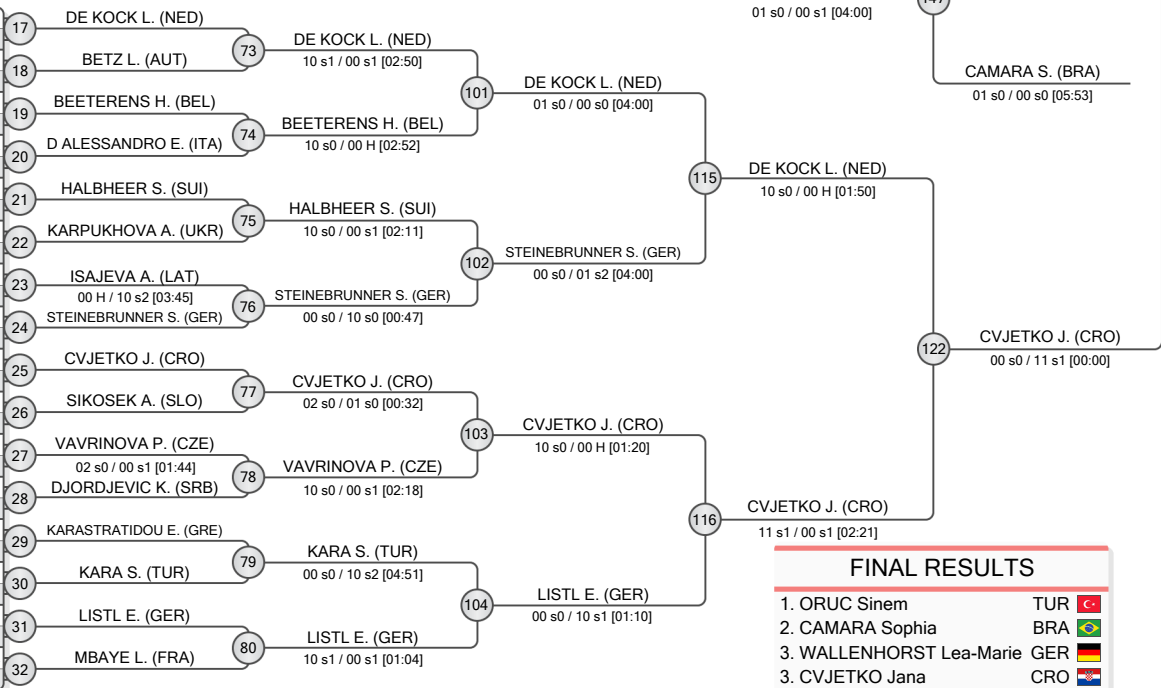

FINAL RESULTS		
1.	ORUC Sinem	TUR
2.	CAMARA Sophia	BRA
3.	WALLENHORST Lea-Marie	GER
3.	CVJETKO Jana	CRO
5.	GLUBIAK Magda	POL
5.	TATAJ Julia	POL
7.	DE KOCK Luna	NED
7.	PTASINSKA Amelia	POL

REPECHAGE

GBR	125	AUBERT GOMEZ M. (GBR)
GER	129	WINTER L. (GER)
SLO	126	SIKOSEK A. (SLO)
AUS	127	WOODWARD G. (AUS)
CZE	128	SIMUNKOVA A. (CZE)

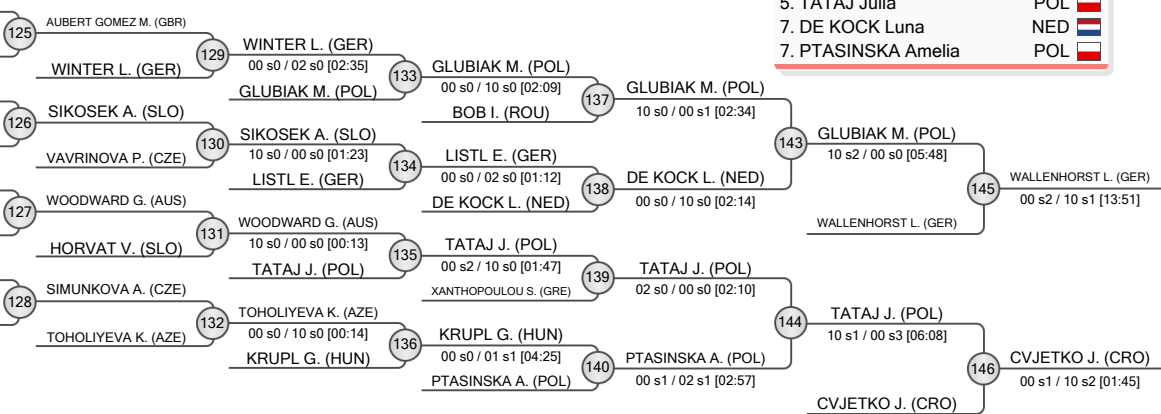



Teplice Cadet European Cup 2023

Czech Republic, Teplice, 8-9 Apr 2023

-70 kg

Women (36)

POOL A

1	HOJDAROVA S. (CZE)	33	HOJDAROVA S. (CZE)
2	CRAPEZ L. (BEL)		10 s0 / 00 s0 [00:20]
3	HAPPE L. (GER)		
4	JONGSTRA L. (NED)	34	HAPPE L. (GER)
			02 s0 / 00 s0 [01:03]
5	SZYMANIAK J. (POL)		
6	NEUMANN M. (GER)	35	NEUMANN M. (GER)
			00 s1 / 10 s0 [03:07]
7	GULENAY T. (TUR)		
8	ZAVRSNIK M. (SLO)	36	GULENAY T. (TUR)
			10 s0 / 00 s0 [02:30]

POOL B

9	MILJEVIC V. (CRO)		
10	STALIONYTE P. (LTU)	37	MILJEVIC V. (CRO)
			10 s0 / 00 s0 [00:34]
11	KOCABEY C. (TUR)		
12	GANZA J. (GER)	38	KOCABEY C. (TUR)
			11 s0 / 00 s0 [01:44]
13	VEN P. (HUN)		
14	NEBOUT A. (FRA)	39	NEBOUT A. (FRA)
			00 s1 / 02 s0 [03:05]
15	WALDHOER J. (AUT)		
16	TOMANOVA N. (CZE)	40	TOMANOVA N. (CZE)
			00 s0 / 10 s0 [02:46]

POOL C

17	NAVICKAITE M. (LTU)		
18	CANDAN C. (TUR)	41	NAVICKAITE M. (LTU)
			10 s0 / 00 H [00:57]
19	BOUVIER M. (BEL)		
20	ERKKILA I. (FIN)	42	BOUVIER M. (BEL)
			01 s0 / 00 s1 [06:58]
21	VAN LIJF X. (NED)		
22	SENGER K. (BRA)	43	VAN LIJF X. (NED)
			10 s1 / 00 s2 [02:21]
23	ZRUCKA A. (CZE)		
24	WETTIG L. (GER)	44	VAN LIJF X. (NED)
			10 s0 / 00 s1 [01:13]
			WETTIG L. (GER)
			00 s0 / 02 s0 [02:43]

POOL D

25	OLIINYK-KORNIKO A. (UKR)		
26	NEMCOVA B. (CZE)	45	OLIINYK-KORNIKO A. (UKR)
			10 s0 / 00 s0 [00:44]
27	THIELE A. (GER)		
28	JONGSTRA A. (NED)	46	THIELE A. (GER)
			10 s2 / 00 s1 [05:23]
29	ANDRIC A. (SRB)		
30	OLIVEIRA Y. (BRA)	47	ANDRIC A. (SRB)
			02 s0 / 00 s0 [01:14]
31	LUEDEMANN J. (GER)		
32	DIAS P. (POR)	48	ANDRIC A. (SRB)
			11 s0 / 00 s1 [01:26]
			LUEDEMANN J. (GER)
			00 s0 / 10 s2 [03:07]
			DIAS P. (POR)
			00 s0 / 10 s0 [00:28]

REPECHAGE

61	ZAVRSNIK M. (SLO)	65	NEUMANN M. (GER)	69	HOJDAROVA S. (CZE)	75	MILJEVIC V. (CRO)	77	VAN LIJF X. (NED)
			00 s1 / 10 s2 [06:00]		00 s0 / 02 s1 [01:44]		00 s0 / 10 s0 [00:09]		00 s2 / 11 s0 [03:45]
			NEUMANN M. (GER)		HOJDAROVA S. (CZE)		MILJEVIC V. (CRO)		
			00 s0 / 10 s0 [00:44]				00 s3 / 10 s2 [02:19]		
62	VEN P. (HUN)	66	VEN P. (HUN)	70	MILJEVIC V. (CRO)	76	OLIINYK-KORNIKO A. (UKR)	78	OLIINYK-KORNIKO A. (UKR)
			10 s0 / 00 s1 [02:07]		00 s3 / 10 s0 [04:05]		00 s2 / 02 s2 [03:19]		10 s0 / 00 s3 [01:45]
			TOMANOVA N. (CZE)		NAVICKAITE M. (LTU)		NEBOUT A. (FRA)		
			MILJEVIC V. (CRO)		00 s1 / 02 s0 [01:00]				
63	SENGER K. (BRA)	67	WETTIG L. (GER)	71	NAVICKAITE M. (LTU)				
			01 s0 / 10 s0 [00:39]						
			WETTIG L. (GER)						
			01 s0 / 10 s0 [00:39]						
64	OLIVEIRA Y. (BRA)	68	OLIVEIRA Y. (BRA)	72	OLIINYK-KORNIKO A. (UKR)				
			10 s0 / 00 s2 [01:36]		01 s0 / 10 s0 [01:40]				
			DIAS P. (POR)						
			OLIINYK-KORNIKO A. (UKR)						
			OLIINYK-KORNIKO A. (UKR)						

FINAL RESULTS	
1.	GULENAY Tuana TUR
2.	ANDRIC Aleksandra SRB
3.	VAN LIJF Xanne NED
3.	OLIINYK-KORNIKO Anna UKR
5.	MILJEVIC Vedrana CRO
5.	NEBOUT Anais FRA
7.	HOJDAROVA Stepanka CZE
7.	NAVICKAITE Marta LTU





Teplice Cadet European Cup 2023

Czech Republic, Teplice, 8-9 Apr 2023

+ 70 kg

Women (31)

POOL A

	SCHRATTENHOLZER Helene	AUT
	VISA Roxana	ROU
	GUCTEKIN Irmak Ceylan	TUR
	MANE Rosa	POR
	ESSIEMI OKALE Sweety	FRA
	FILKOROVA Nina	SVK
	WIDLAK Nicole	POL

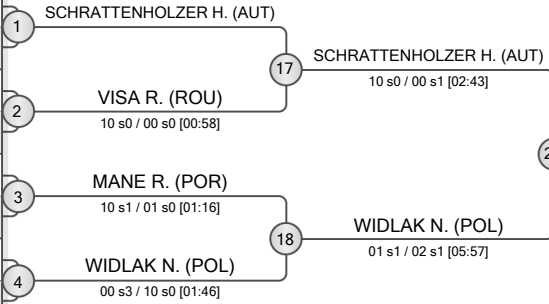

POOL B

	DIANKOLELA-BINIAKOUNOU Quessia	FRA
	EININGE Saule	LTU
	METE Sema	TUR
	KASZPEROVA Kristyna	CZE
	AKTAS Emma-Melis	EST
	MUSIC Maja	SLO
	NOECKL Johanna	AUT
	NIEWELER Malin	GER

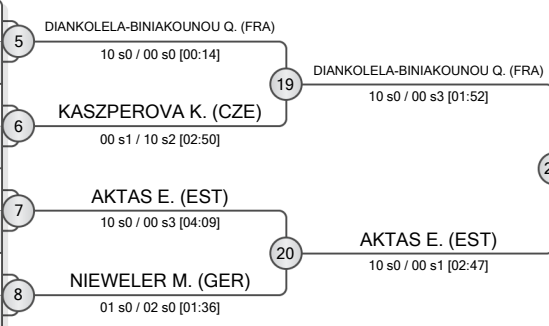

POOL C

	BANASZEWSKA Zuzanna	POL
	SOARES Ana	BRA
	COCIORBA Ioana	ROU
	DOLIA Daria	UKR
	SALA CANO Aitana	ESP
	POLLHAMMER Katrin	AUT
	FERON Alainah	FRA
	ARDIC Hayrun Nisa	TUR

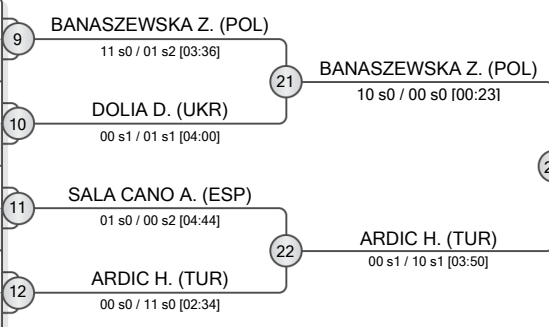

POOL D

	KOSNAROVA Marie	CZE
	ACHACHERA Adela	FRA
	DILBIRLIGI Kevser	TUR
	PLOEHNERT Peppa	GER
	ODOR Veronika	HUN
	MITAKIDOU Ilektra-Evangelia	GRE
	EINORYTE Toma	LTU
	MILOSEVIC Jovana	SRB

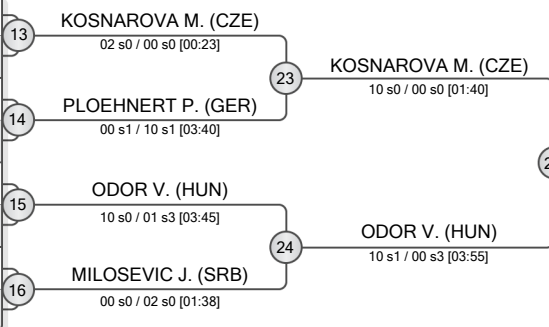

REPECHAGE

	VISA R. (ROU)	29	VISA R. (ROU)	33	VISA R. (ROU)
	MUSIC M. (SLO)		WIDLAK N. (POL)		
	NIEWELER M. (GER)	30	MUSIC M. (SLO)	34	DIANKOLELA-BINIAKOUNOU Q. (FRA)
	SOARES A. (BRA)		DIANKOLELA-BINIAKOUNOU Q. (FRA)		
	DOLIA D. (UKR)	31	SOARES A. (BRA)	35	SOARES A. (BRA)
	ACHACHERA A. (FRA)		ARDIC H. (TUR)		
	PLOEHNERT P. (GER)	32	PLOEHNERT P. (GER)	36	PLOEHNERT P. (GER)
			ODOR V. (HUN)		

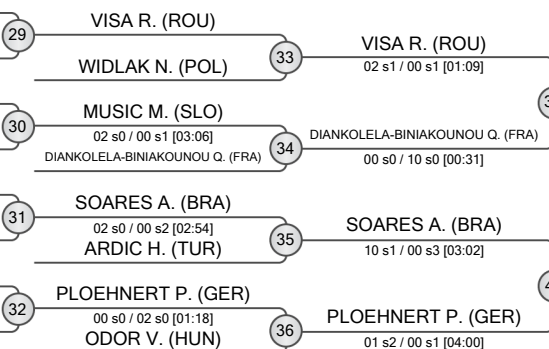

BANASZEWSKA Z. (POL) 43
00 s0 / 10 s0 [02:21]

BANASZEWSKA Z. (POL) 38
11 s1 / 00 s2 [02:31]

FINAL RESULTS	
1. BANASZEWSKA Zuzanna	POL
2. SCHRATTENHOLZER Helene	AUT
3. KOSNAROVA Marie	CZE
3. AKTAS Emma-Melis	EST
5. DIANKOLELA-BINIAKOUNOU Quessia	FRA
5. SOARES Ana	BRA
7. VISA Roxana	ROU
7. PLOEHNERT Peppa	GER

