

POOL A

	JEAN Enzo	FRA
	KARSLI Mizam	TUR
	ANDJELOVIC Rastko	SRB
	VAN HARTEN Jochem	NED
	ROMNAES Marcus	NOR

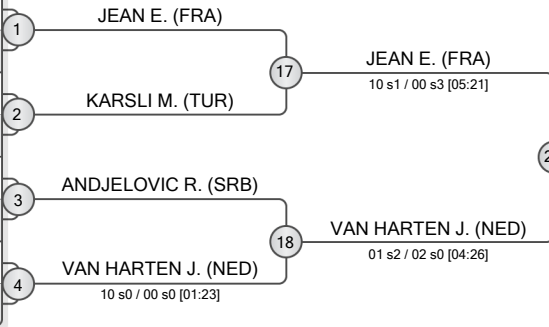

POOL B

	ANGHEL Andrei	ROU
	MULALIC Ahmed	BIH
	IGNASIAK Ksawery	POL
	ZADRAVEC Gabriel	SLO
	KEZIC Dusan	SRB

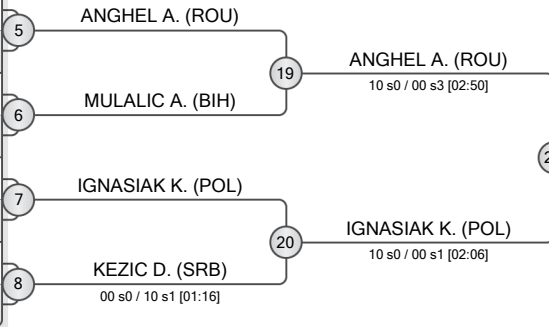

POOL C

	MATEI Alexandru	ROU
	KLEINOS Anton	POL
	LEDJANSKI Ivan	SRB
	HRISTOV Hristo	BUL
	CRETNIK Andraz	SLO
	RUZA Lukas	CZE

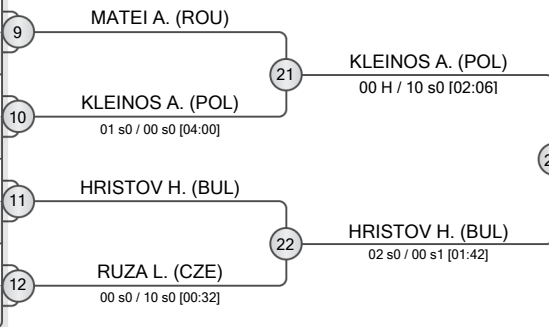

POOL D

	FARKAS Bence	HUN
	AMARASEKARA Egilsten	NOR
	WITTEVEEN Twan	NED
	RADOVIC Petar	MNE
	NISIC Nemanja	SRB

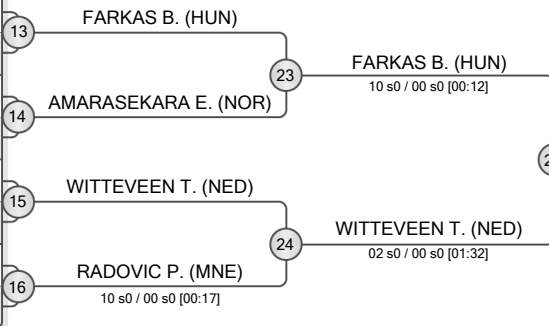

REPECHAGE

ROMNAES M. (NOR)	ANDJELOVIC R. (SRB)	29
ANDJELOVIC R. (SRB)	KEZIC D. (SRB)	30
KEZIC D. (SRB)	LEDJANSKI I. (SRB)	31
LEDJANSKI I. (SRB)	MATEI A. (ROU)	32
MATEI A. (ROU)	AMARASEKARA E. (NOR)	33
AMARASEKARA E. (NOR)	WITTEVEEN T. (NED)	34
WITTEVEEN T. (NED)	ANDJELOVIC R. (SRB)	35
ANDJELOVIC R. (SRB)	JEAN E. (FRA)	36
JEAN E. (FRA)	ANGHEL A. (ROU)	37
ANGHEL A. (ROU)	MATEI A. (ROU)	38
MATEI A. (ROU)	HRISTOV H. (BUL)	39
HRISTOV H. (BUL)	AMARASEKARA E. (NOR)	40
AMARASEKARA E. (NOR)	WITTEVEEN T. (NED)	41
WITTEVEEN T. (NED)	ANDJELOVIC R. (SRB)	42
ANDJELOVIC R. (SRB)	JEAN E. (FRA)	43

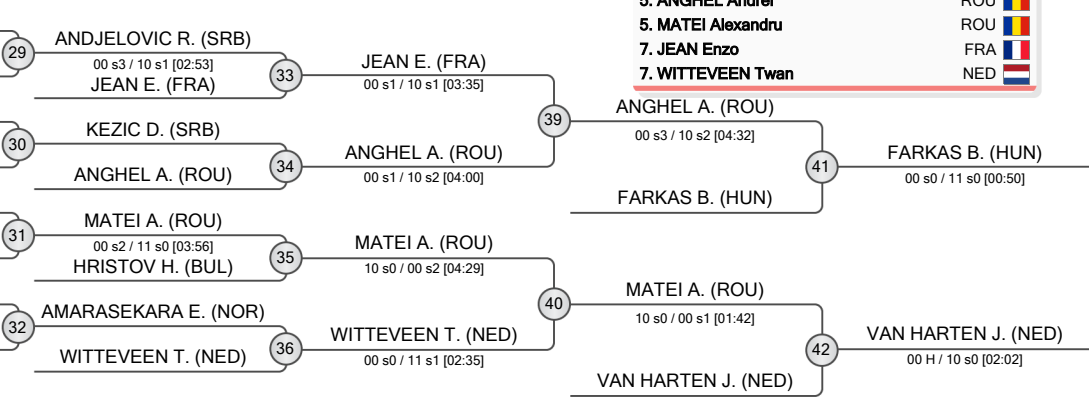

FINAL RESULTS	
1.	IGNASIAK Ksawery
2.	KLEINOS Anton
3.	FARKAS Bence
4.	VAN HARTEN Jochem
5.	ANGHEL Andrei
6.	MATEI Alexandru
7.	JEAN Enzo
8.	WITTEVEEN Twan



# Banja Luka Junior European Cup 2022

Bosnia and Herzegovina, Banja Luka, 25-26 Jun 2022

# -66 KG

Men (30)

POOL A

	ACCOGLI Valerio	ITA
	YOTOV Boyan	BUL
	BRIOLAS Vasileios	GRE
	GABOR Aron	HUN
	VUKOVIC Aleksandar	BIH
	BRENCE Miha	SLO
	MELLENDEZ Gabriel	NED

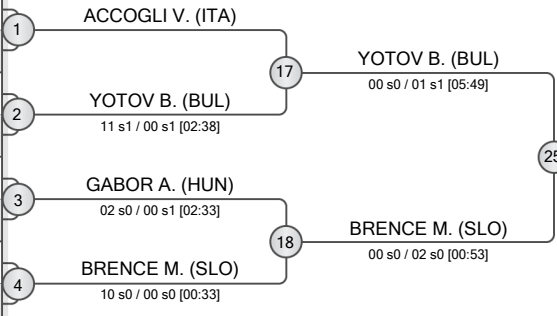

POOL B

	GOMBAS Balint	HUN
	ZIVKOVIC Filip	BIH
	JUG Primoz	SLO
	MORAVIK Jan, CZE	CZE
	LIPARD Viljar	EST
	LOJANICIC Marko	SRB
	ZOROTOVIC Nikola	CRO
	MAASKANT Paolo	NED

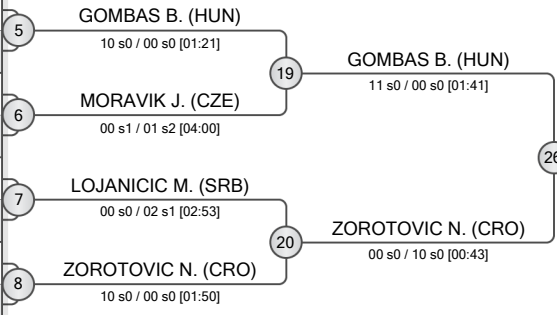

POOL C

	MASSON JBILOU Driss	FRA
	KLACAR Dani	CRO
	FURST CRTANEC Tobias	SLO
	KRIJTJE Nanco	NED
	MULALIC Arslan	BIH
	HRISTOV Alen	BUL
	ALFONSO Dario	LIE

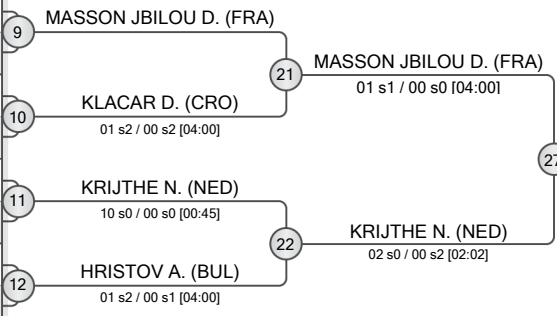

POOL D

	MOUNDANGA Maxime	FRA
	WINTER Tim	NED
	NIEMENKARI Kasper	FIN
	KOKALJ Gasper	SLO
	BROVOLD Gustav	NOR
	MRVALJEVIC Balsa	MNE
	MACAR Uros	BIH
	NOVACEK Vaclav	CZE

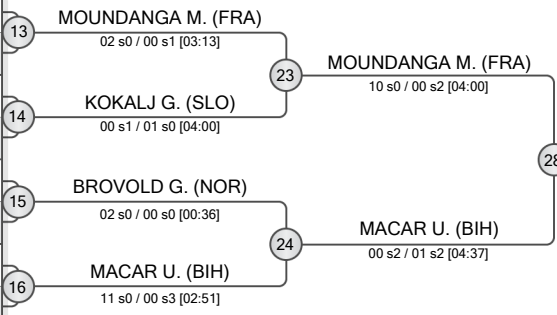

REPECHAGE

BRIOLAS V. (GRE)	29 ACCOGLI V. (ITA) vs 30 MORAVIK J. (CZE) [00:49] → 33
ACCOGLI V. (ITA)	33 ACCOGLI V. (ITA) vs 34 ZOROTOVIC N. (CRO) [02:02] → 39
ZIVKOVIC F. (BIH)	39 ACCOGLI V. (ITA) vs 40 KRIJTJE N. (NED) [04:00] → 41
MORAVIK J. (CZE)	41 MOUNDANGA M. (FRA) vs 42 KRIJTJE N. (NED) [04:00] → 43
KLACAR D. (CRO)	31 KLACAR D. (CRO) vs 32 KOKALJ G. (SLO) [01:08] → 35
WINTER T. (NED)	35 KRIJTJE N. (NED) vs 36 KOKALJ G. (SLO) [02:52] → 40
KOKALJ G. (SLO)	40 KRIJTJE N. (NED) vs 42 KRIJTJE N. (NED) [02:18] → 43

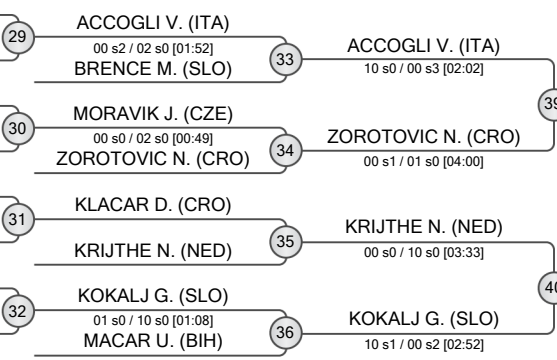

FINAL RESULTS	
1. GOMBAS Balint	HUN
2. MASSON JBILOU Driss	FRA
3. KRIJTJE Nanco	NED
3. MOUNDANGA Maxime	FRA
5. YOTOV Boyan	BUL
5. ACCOGLI Valerio	ITA
7. ZOROTOVIC Nikola	CRO
7. KOKALJ Gasper	SLO



POOL A

1	ZOUBKO Daniyl (FRA)	33	ZOUBKO D. (FRA)
2	BARCZIKAY Akos (HUN)	33	ZOUBKO D. (FRA)
3	STANIMIROVIC Vukan (SRB)	34	STANIMIROVIC V. (SRB)
4	KAVCIC Leon (SLO)	34	STANIMIROVIC V. (SRB)
5	ROZGA Josip (CRO)	34	STANIMIROVIC V. (SRB)
5	SZABO Aron (HUN)	35	SZABO A. (HUN)
6	ANTELJ Srdjan (SRB)	35	SZABO A. (HUN)
7	PANDUREVIC Srdjan (BIH)	36	PANDUREVIC S. (BIH)
8	RANKINEN Jere (FIN)	36	PANDUREVIC S. (BIH)

POOL B

9	KOWALSKI Marcin (POL)	37	KOWALSKI M. (POL)
10	DOBROSY Almos (HUN)	37	KOWALSKI M. (POL)
11	VAN TEIJLINGEN Jelle (NED)	38	VAN TEIJLINGEN J. (NED)
12	PETROVSKI Aleksandar (SRB)	38	VAN TEIJLINGEN J. (NED)
13	NAIRNE Ethan (GBR)	39	NAIRNE E. (GBR)
14	TOPALOVIC Darko (BIH)	39	NAIRNE E. (GBR)
15	RAKOCEVIC Matija (MNE)	40	RAKOCEVIC M. (MNE)
16	KORDULA Daniel (CZE)	40	RAKOCEVIC M. (MNE)

POOL C

17	AHIBO Hans-Jorris (FRA)	41	AHIBO H. (FRA)
18	SZEGEDI Daniel (HUN)	41	SZEGEDI D. (HUN)
19	BREKKE-JENSSEN Martin (NOR)	42	DJORDJEVIC S. (SRB)
20	DJORDJEVIC Slobodan (SRB)	42	DJORDJEVIC S. (SRB)
21	HERKOVIC Nace (SLO)	43	HERKOVIC N. (SLO)
22	SKRBA Petar (BIH)	43	HERKOVIC N. (SLO)
23	HERMODSSON Olof (SWE)	44	BUBALO A. (SRB)
24	BUBALO Aleksa (SRB)	44	BUBALO A. (SRB)

POOL D

25	ADORJANI Gergely (HUN)	45	ADORJANI G. (HUN)
26	VAN SUILEN Senne (NED)	45	ADORJANI G. (HUN)
27	SUCEVIC Marko (BIH)	46	PETROVIC A. (SRB)
28	PETROVIC Andrija (SRB)	46	PETROVIC A. (SRB)
29	RAJCIC Aleksandar (SRB)	47	RAJCIC A. (SRB)
30	BONEV Valentin (BUL)	47	RAJCIC A. (SRB)
31	KRIZEK Simon (CZE)	48	SARDIDI J. (KSA)
32	SARDIDI Jawad (KSA)	48	SARDIDI J. (KSA)

REPECHAGE

61	ANTELJ Srdjan (SRB)	65	ANTELJ Srdjan (SRB)
62	DOBROSY Almos (HUN)	66	VAN TEIJLINGEN Jelle (NED)
63	SKRBA Petar (BIH)	67	BUBALO Aleksa (SRB)
64	VAN SUILEN Senne (NED)	68	PETROVIC Andrija (SRB)

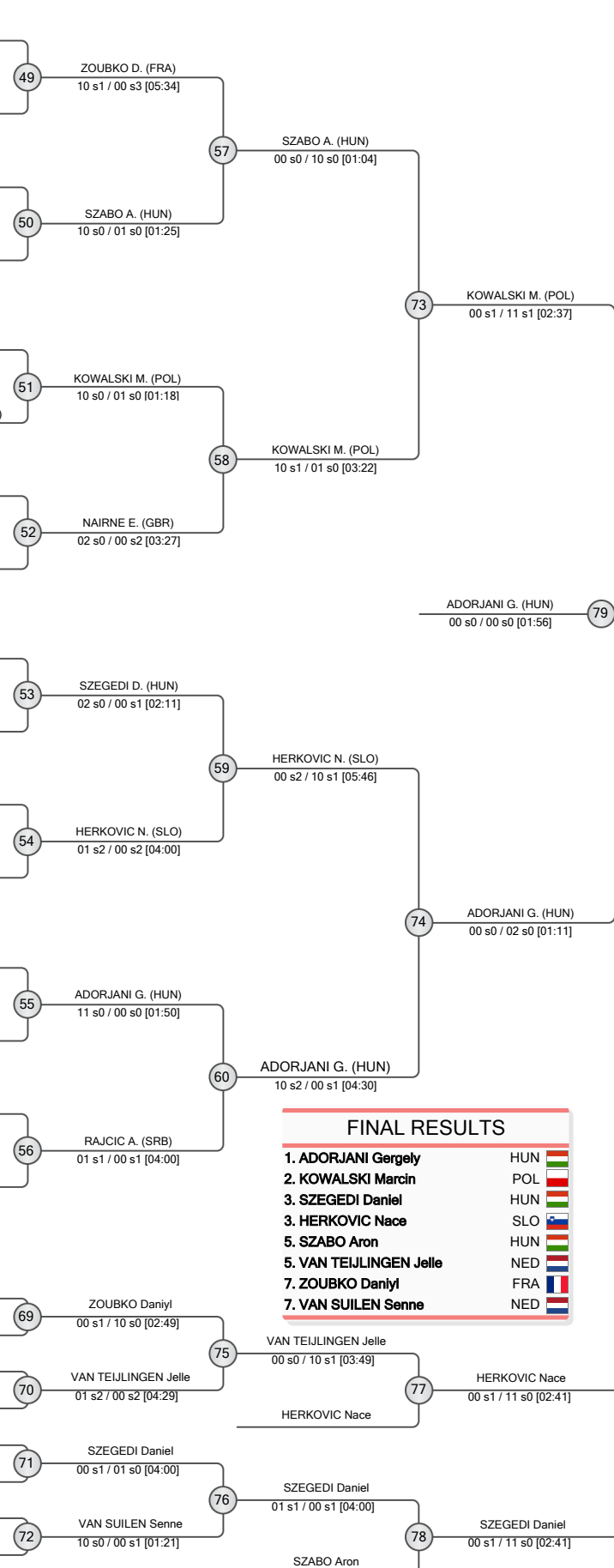

FINAL RESULTS	
1.	ADORJANI Gergely (HUN)
2.	KOWALSKI Marcin (POL)
3.	SZEGEDI Daniel (HUN)
3.	HERKOVIC Nace (SLO)
5.	SZABO Aron (HUN)
7.	VAN TEIJLINGEN Jelle (NED)
7.	ZOUBKO Daniyl (FRA)
7.	VAN SUILEN Senne (NED)



# Banja Luka Junior European Cup 2022

Bosnia and Herzegovina, Banja Luka, 25-26 Jun 2022

# -81 KG

Men (27)

POOL A

	AREGBA Arnaud	FRA
	ROGALSKI Oskar	POL
	BOSVELD Tobias	NED
	SIKOSEK Gaber	SLO
	SOKOLOVIC David	CRO
	KRETIJA Nikola	BIH
	SZTANKO Daniel	HUN

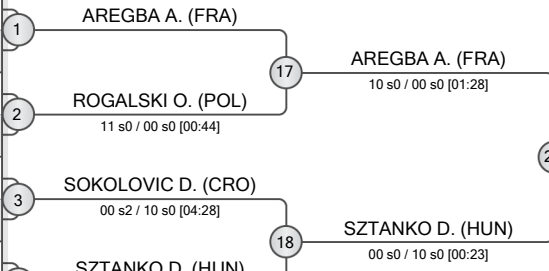

POOL B

	KOSOVIC Velimir	SRB
	REKIC Orhan	BIH
	VAN SINDEREN Mika	NED
	MATTSSON Pelle	SWE
	GEBAUER Ervin	HUN
	KONEV Georgi	BUL

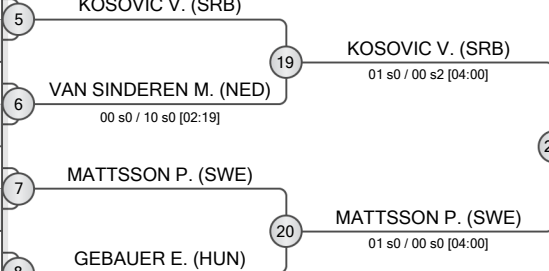

POOL C

	HEBIB Mustafa	BIH
	VELTMEIJER Boris	NED
	DEMETER Marcell	HUN
	DEMETER Bendeguz	HUN
	JANCER Marko	MNE
	KROEGER Sem	NED
	KOLEV Georgi	BUL

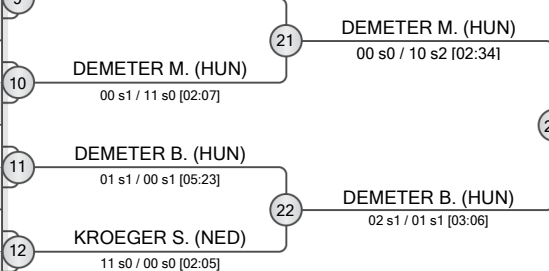

POOL D

	BORZECKI Bartosz	POL
	VAN DUN Mo	NED
	ERDELIC Jovan	BIH
	ZUBOVIC Stefan	SRB
	MIKLOSVOLGYI Daniel	HUN
	NOOR Rohil	NOR
	ZOROTOVIC Luka	CRO

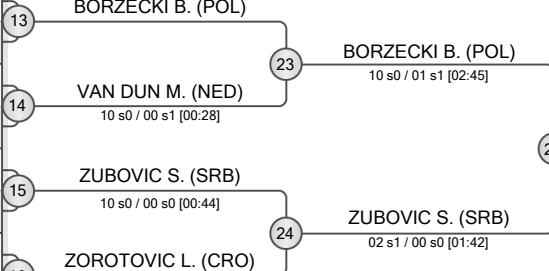

FINAL RESULTS		
1.	AREGBA Arnaud	FRA
2.	ZUBOVIC Stefan	SRB
3.	KOSOVIC Velimir	SRB
3.	SZTANKO Daniel	HUN
5.	HEBIB Mustafa	BIH
5.	DEMETER Marcell	HUN
7.	VAN SINDEREN Mika	NED
7.	BORZECKI Bartosz	POL

REPECHAGE

29	ROGALSKI O. (POL)
30	VAN SINDEREN M. (NED)
31	HEBIB M. (BIH)
32	ZOROTOVIC L. (CRO)
33	SZTANKO D. (HUN)
34	MATTSSON P. (SWE)
35	DEMETER B. (HUN)
36	BORZECKI B. (POL)

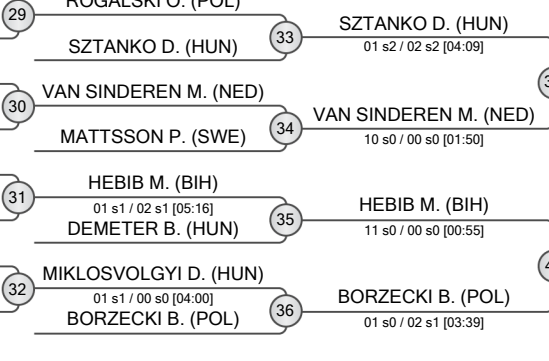



# Banja Luka Junior European Cup 2022

Bosnia and Herzegovina, Banja Luka, 25-26 Jun 2022

# -90 KG

Men (28)

POOL A

	MITROVIC Aleksa	FRA
	LHOTZKY Frantisek	CZE
	PAJIC Stefan	BIH
	DEN HARTOG Floris	NED
	HRIBAR Anej	SLO
	MANDIC Vojin	SRB
	KIELESINSKI Jakub	POL

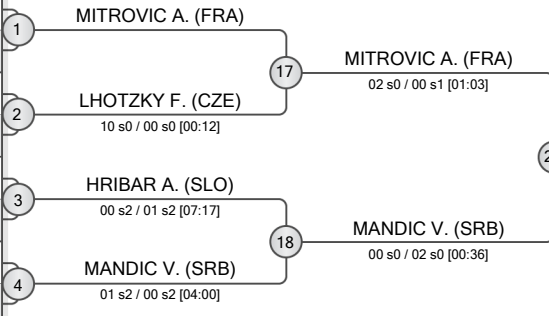

POOL B

	HEEREN Axel	NED
	PURNAT Nik	SLO
	PREVISIC Josip	BIH
	ALI David	FRA
	SAFKHANOV Ruslan	AZE
	ARSENIE Rares	ROU
	MECHOWSKI Dawid	POL

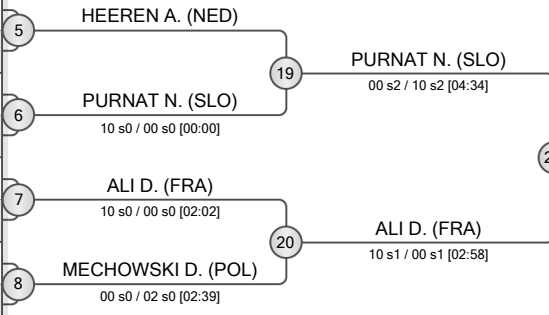

POOL C

	BAATHE Karl	SWE
	RADULJ Miljan	SRB
	BOGDANIUK Jakub	POL
	RIJKSEN SALMAN Ryan	GBR
	KAVNIK Vid	SLO
	HASIC Kerim	BIH
	SIBISAN Alexandru	ROU

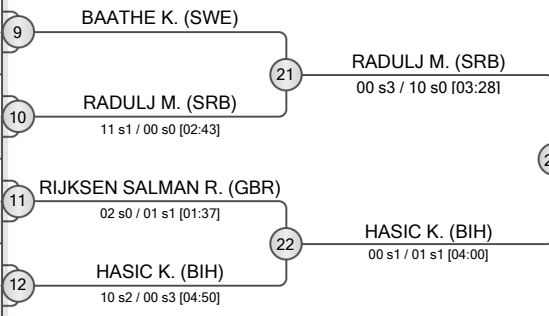

POOL D

	JANCZYLIK Dymitrij	POL
	MAMMADOV Bakhtiyar	AZE
	TACAR Ambroz	SLO
	VLADOV Borislav	BUL
	MILJIC Luka	SRB
	PFAF Michal	CZE
	PAJIC Djordje	BIH

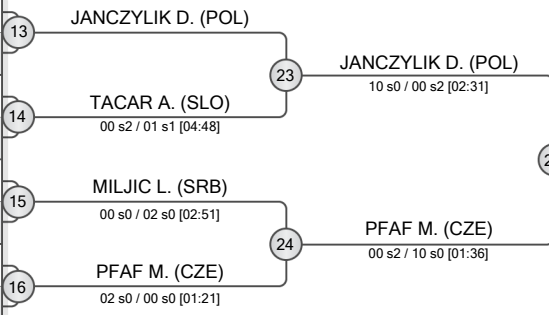

FINAL RESULTS		
1.	MITROVIC Aleksa	FRA
2.	RADULJ Miljan	SRB
3.	ALI David	FRA
4.	PURNAT Nik	SLO
5.	PFAF Michal	CZE
6.	JANCZYLIK Dymitrij	POL
7.	LHOTZKY Frantisek	CZE
8.	BOGDANIUK Jakub	POL

REPECHAGE

LHOTZKY F. (CZE) 29	LHOTZKY F. (CZE) 33
SAFKHANOV R. (AZE) 30	SAFKHANOV R. (AZE) 34
MECHOWSKI D. (POL) 31	BOGDANIUK J. (POL) 35
BOGDANIUK J. (POL) 32	BOGDANIUK J. (POL) 36
BAATHE K. (SWE) 33	TACAR A. (SLO) 37
TACAR A. (SLO) 34	PFAF M. (CZE) 38

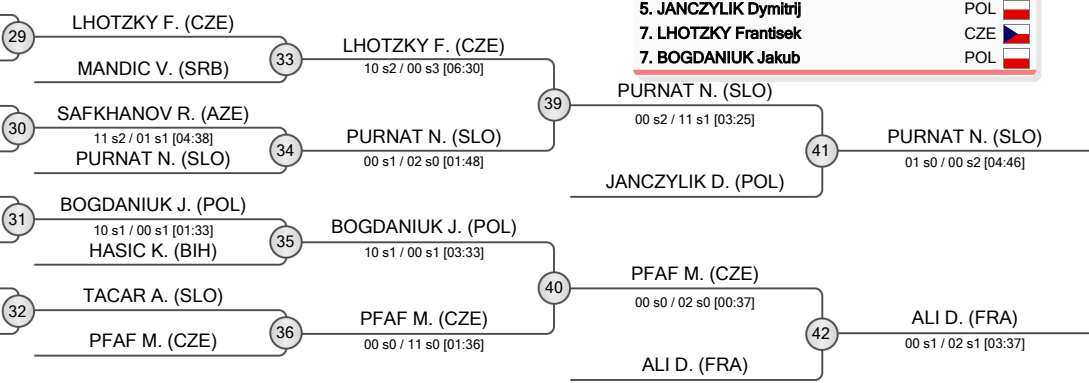



# Banja Luka Junior European Cup 2022

Bosnia and Herzegovina, Banja Luka, 25-26 Jun 2022

# -100 KG

Men (11)

POOL A

	LIVEZE Kenny	FRA
	HAVASI Balint	HUN
	JOZELJIC Domagoj	BIH

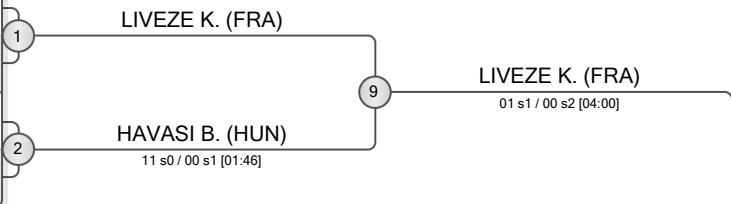

POOL B

	STOKOV Aleksandar	SRB
	DEMIROVIC Adnan	BIH
	BERTALANIC ZIZEK Gal	SLO

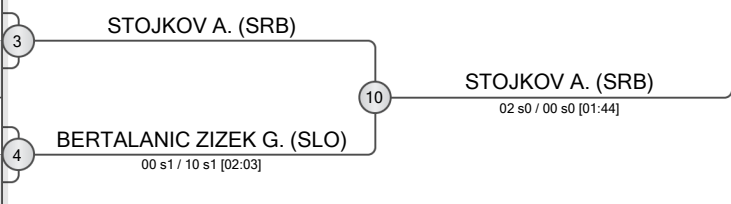

POOL C

	ANGLIONIN Mathias	FRA
	HADZIAVDIC Ahmed	BIH
	STEFANOV Stanislav	BUL

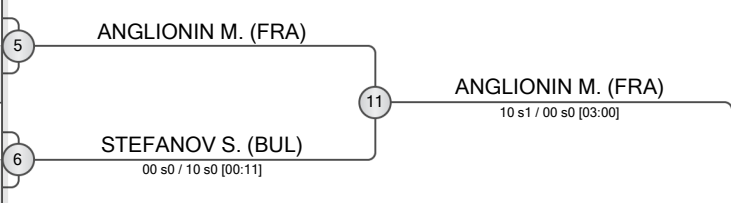

POOL D

	ROSWALL Lukas	SWE
	GAZDIC Ognjen	BIH

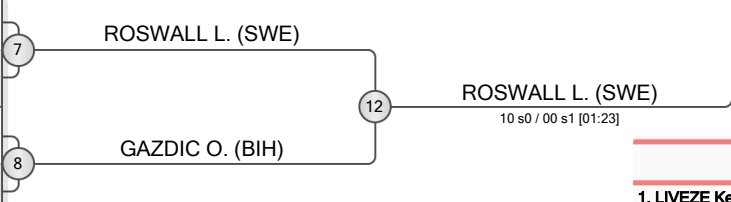

REPECHAGE

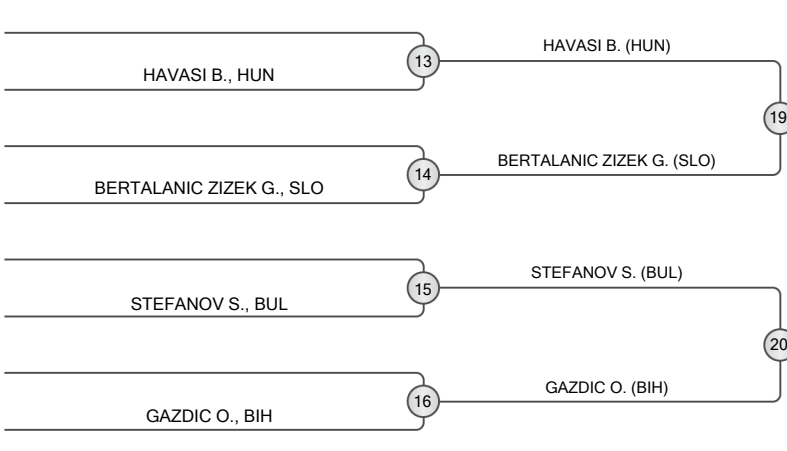

FINAL RESULTS		
1.	LIVEZE Kenny	FRA
2.	ANGLIONIN Mathias	FRA
3.	ROSWALL Lukas	SWE
3.	STOKOV Aleksandar	SRB
5.	HAVASI Balint	HUN
5.	GAZDIC Ognjen	BIH
7.	BERTALANIC ZIZEK Gal	SLO
7.	STEFANOV Stanislav	BUL



POOL A

GOMES DA SILVA Mathys FRA

POOL B

TERESINSKI Grzegorz POL  
 MAMMEDZADA Mahammad AZE

POOL C

STOSIC Andrija SRB  
 SAVIC Patrik BIH

POOL D

SORDYL Jakub POL  
 MANAIE Saud KSA

REPECHAGE

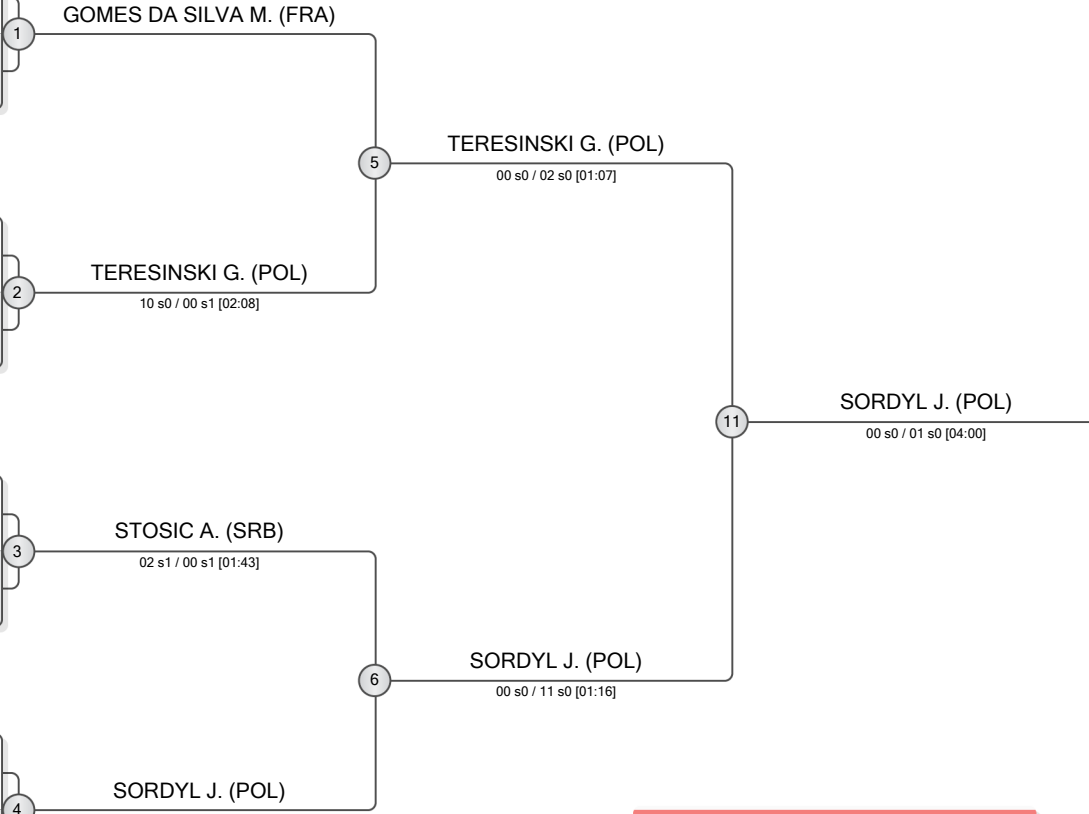
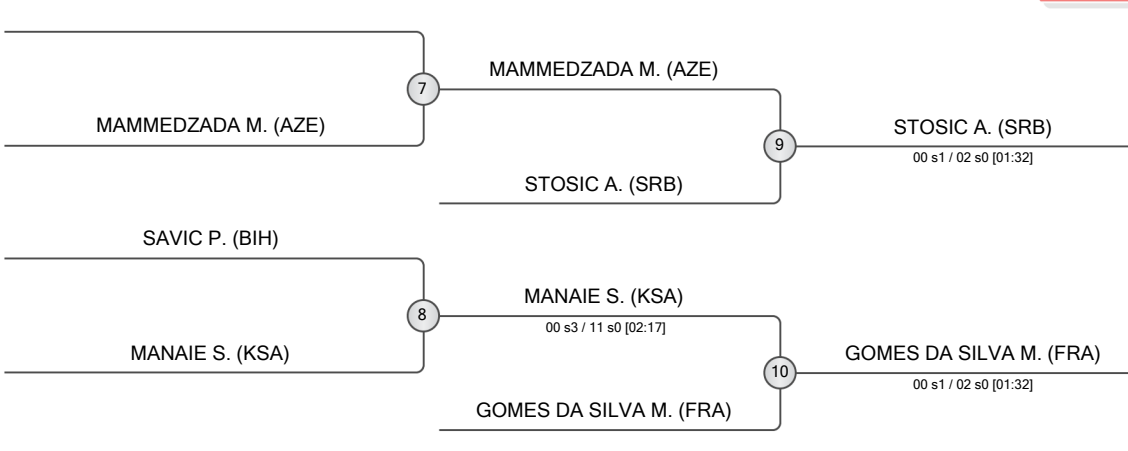

FINAL RESULTS	
1. SORDYL Jakub	
2. TERESINSKI Grzegorz	
3. GOMES DA SILVA Mathys	
3. STOSIC Andrija	
5. MANAIE Saud	
5. MAMMEDZADA Mahammad	
7. SAVIC Patrik	
7.	

POOL A

	CUQ Pauline	FRA
	PAAR Viktoria	HUN

1 CUQ P. (FRA)

10 s0 / 00 s0 [00:37]

POOL B

	ONYSK Oliwia	POL
	GEORGIEVA Aleksa	BUL

2 ONYSK O. (POL)

01 s0 / 00 s1 [04:27]

POOL C

	ALIYEVA Konul	AZE
	MOLDOVEANU Iulia	ROU

3 ALIYEVA K. (AZE)

01 s1 / 00 s1 [04:00]

POOL D

	KOSZEGI Rebeka Rita	HUN
	STOKLOSA Natalia	POL

4 STOKLOSA N. (POL)

00 s3 / 10 s0 [04:15]

REPECHAGE

PAAR V. (HUN)

GEORGIEVA A. (BUL)

MOLDOVEANU I. (ROU)

KOSZEGI R. (HUN)

7 GEORGIEVA A. (BUL)

00 s0 / 10 s0 [00:50]

8 KOSZEGI R. (HUN)

00 s0 / 11 s2 [04:00]

10 ONYSK O. (POL)

5

6

9

10

5 CUQ P. (FRA)

02 s0 / 01 s2 [03:58]

6 ALIYEVA K. (AZE)

10 s0 / 00 s0 [01:33]

11

11 CUQ P. (FRA)

11 s0 / 00 s0 [02:05]

### FINAL RESULTS

1. CUQ Pauline	FRA	
2. ALIYEVA Konul	AZE	
3. STOKLOSA Natalia	POL	
3. KOSZEGI Rebeka Rita	HUN	
5. GEORGIEVA Aleksa	BUL	
5. ONYSK Oliwia	POL	
7. PAAR Viktoria	HUN	
7. MOLDOVEANU Iulia	ROU	





# Banja Luka Junior European Cup 2022

Bosnia and Herzegovina, Banja Luka, 25-26 Jun 2022

# -52 KG

Women (10)

POOL A

	KELLER Rebeka	HUN
	VAN DER SALM Franka	NED
	ARGINT Diana	ROU

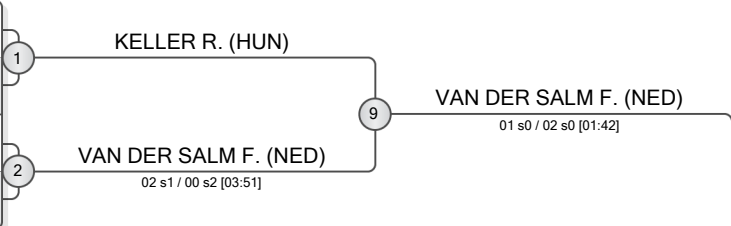

POOL B

	MIHHAILOVA Darja	EST
	KLIMCZAK Kinga	POL

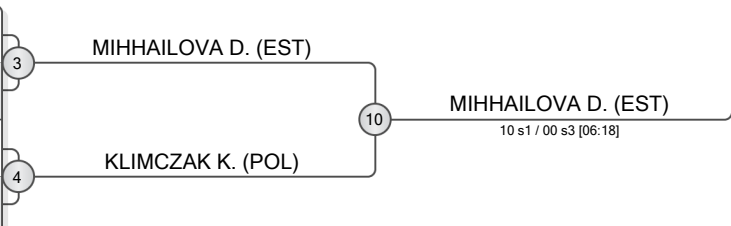

POOL C

	NISAVIC Nikolina	SRB
	BADICEANU Florina	ROU
	MAMIRA Luca	HUN

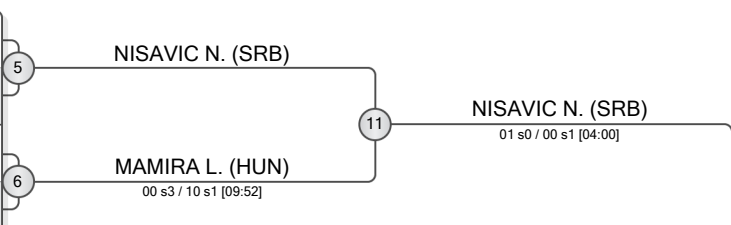

POOL D

	DE CARVALHO Alya	FRA
	PETROVIC Mila	BIH

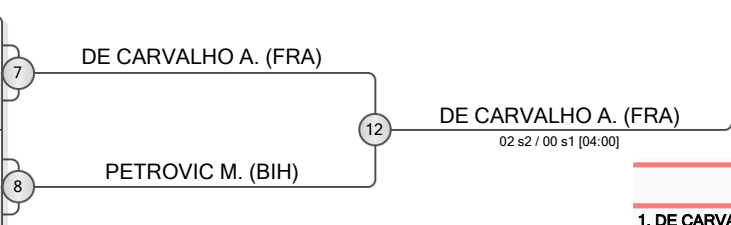

REPECHAGE

ARGINT D., ROU	13
KELLER R., HUN	13
KLIMCZAK K., POL	14
MAMIRA L., HUN	15
PETROVIC M., BIH	16

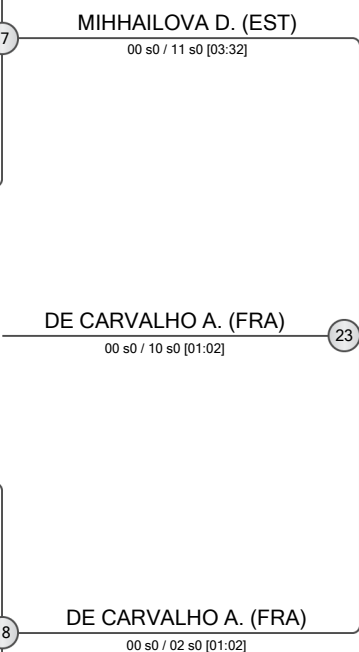
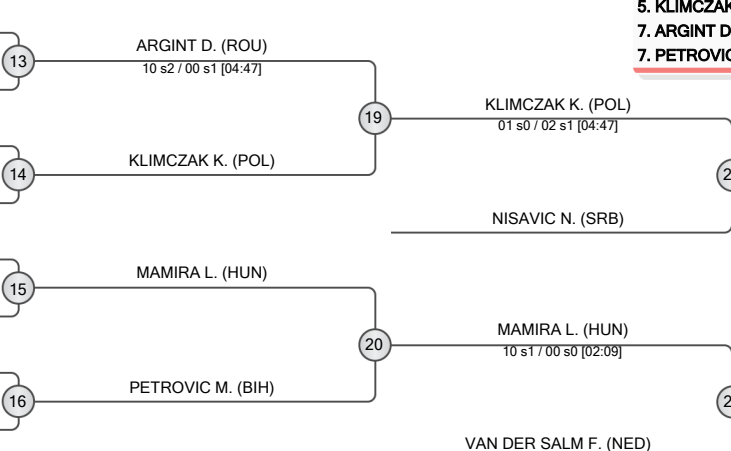

FINAL RESULTS		
1.	DE CARVALHO Alya	FRA
2.	MIHHAILOVA Darja	EST
3.	MAMIRA Luca	HUN
3.	NISAVIC Nikolina	SRB
5.	VAN DER SALM Franka	NED
5.	KLIMCZAK Kinga	POL
7.	ARGINT Diana	ROU
7.	PETROVIC Mila	BIH





# Banja Luka Junior European Cup 2022

Bosnia and Herzegovina, Banja Luka, 25-26 Jun 2022

# -57 KG

Women (16)

POOL A

	COTARD Maelenn	FRA
	RASPE Vera	NED
	LAIHO Venla	FIN
	BERLIK Dorottya	HUN

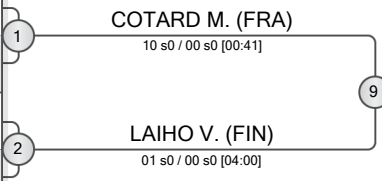

POOL B

	TARKUS Merit	EST
	OLDAK Alicja	POL
	SKRABL Ana	SLO
	DJUKIC Tamara	BIH

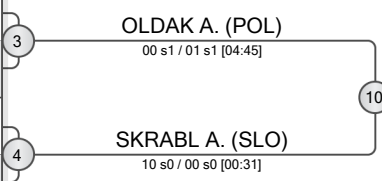

POOL C

	FAWAZ Martha	FRA
	KOKALJ Ziva	SLO
	GRANBERG Tova	SWE
	MAATS Floor	NED

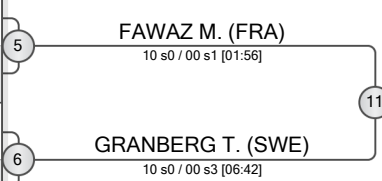

POOL D

	LEMIRE Lou	FRA
	BJOERAAS Elise	NOR
	WATOREK Oliwia	POL
	ABBASOVA Latifa	AZE

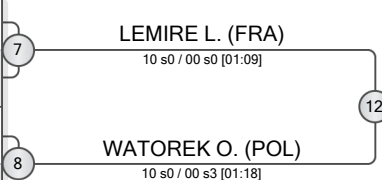

REPECHAGE

RASPE V., NED	13
LAIHO V., FIN	14
DJUKIC T., BIH	15
OLDAK A., POL	16
KOKALJ Z., SLO	17
GRANBERG T., SWE	18
BJOERAAS E., NOR	19
WATOREK O., POL	20

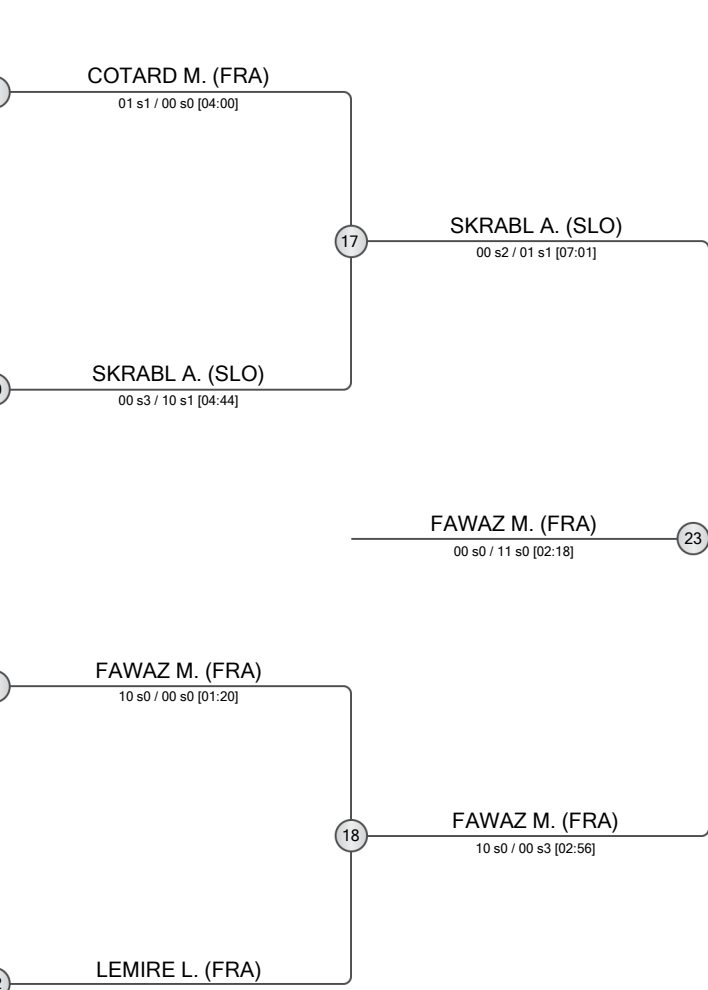
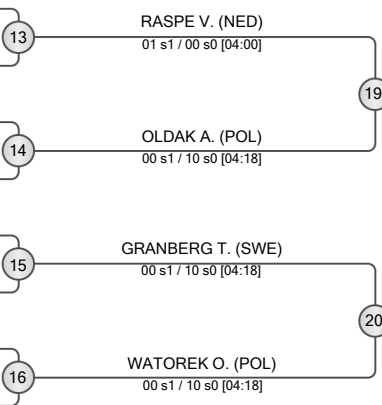

FINAL RESULTS		
1. FAWAZ Martha	FRA	
2. SKRABL Ana	SLO	
3. LEMIRE Lou	FRA	
3. COTARD Maelenn	FRA	
5. RASPE Vera	NED	
5. GRANBERG Tova	SWE	
7. OLDAK Alicja	POL	
7. WATOREK Oliwia	POL	



POOL A

	NALBAT Kamile	NED
	NISAVIC Kristina	SRB
	SEIKKULA Louna-Lumia	FIN

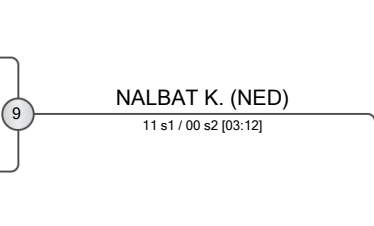
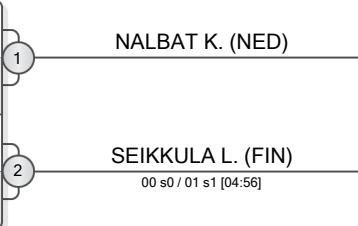

POOL B

	PALKA Agata	POL
	FALGON Julie	FRA
	VIT Lili	HUN

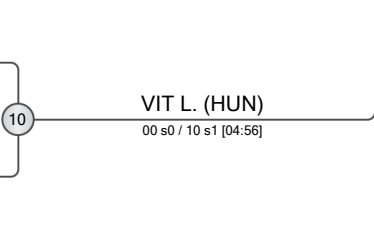
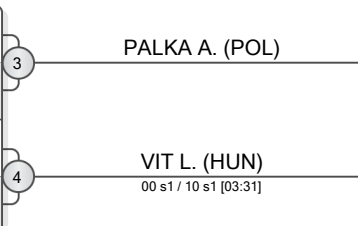

POOL C

	AUCHECORNE Melkia	FRA
	CORBO Sara	ITA
	STOJANOVIC Darija	BIH

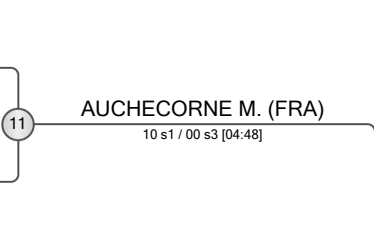
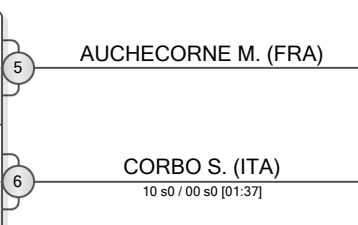

POOL D

	GARDASHKHANLI Aytaj	AZE
	SCHUSTER Kaja	SLO
	KONFISZ Amelia	POL

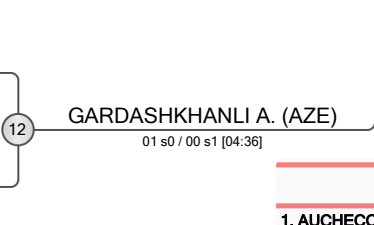
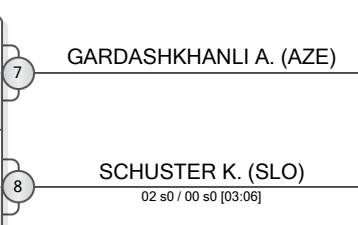

REPECHAGE

SEIKKULA L., FIN	13	SEIKKULA L. (FIN)
FALGON J., FRA	14	FALGON J. (FRA)
PALKA A., POL	14	FALGON J. (FRA)
CORBO S., ITA	15	CORBO S. (ITA)
SCHUSTER K., SLO	16	SCHUSTER K. (SLO)
SCHUSTER K., SLO	16	SCHUSTER K. (SLO)

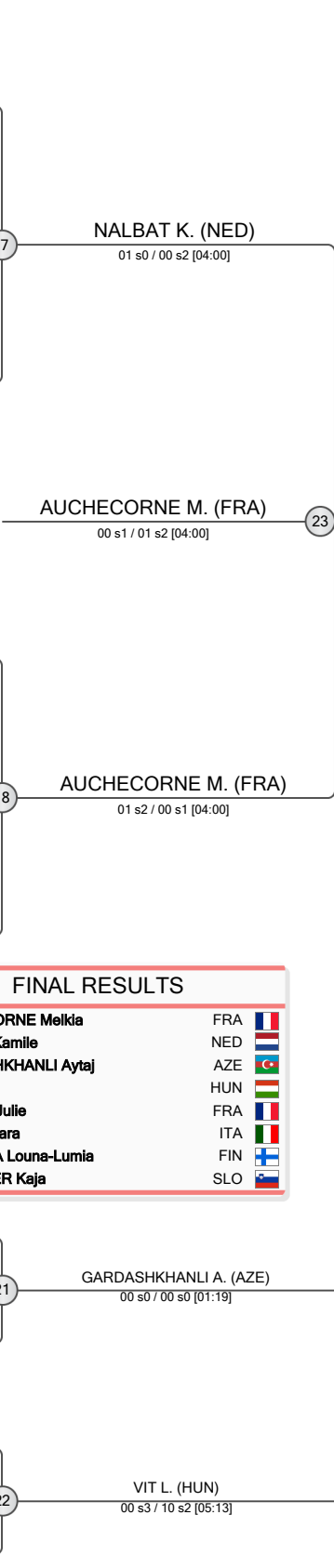
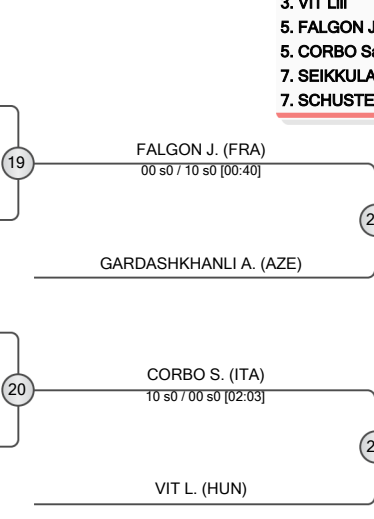
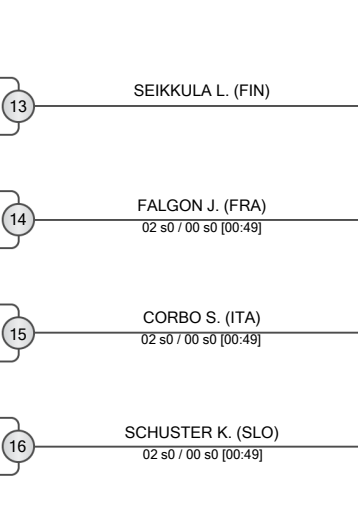

FINAL RESULTS		
1. AUCHECORNE Melkia	FRA	
2. NALBAT Kamile	NED	
3. GARDASHKHANLI Aytaj	AZE	
3. VIT Lili	HUN	
5. FALGON Julie	FRA	
5. CORBO Sara	ITA	
7. SEIKKULA Louna-Lumia	FIN	
7. SCHUSTER Kaja	SLO	



# Banja Luka Junior European Cup 2022

Bosnia and Herzegovina, Banja Luka, 25-26 Jun 2022

# -70 KG

Women (10)

POOL A

	SOBIERAJSKA Katarzyna	POL
	MAZOVEC Ursula	SLO
	STAMOULI Christina	GRE

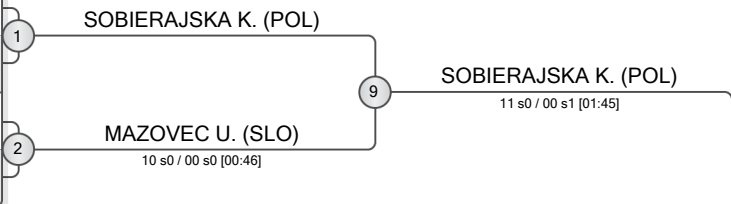

POOL B

	BRANCHEVA Lidia	BUL
	KOVACS Viktoria	HUN

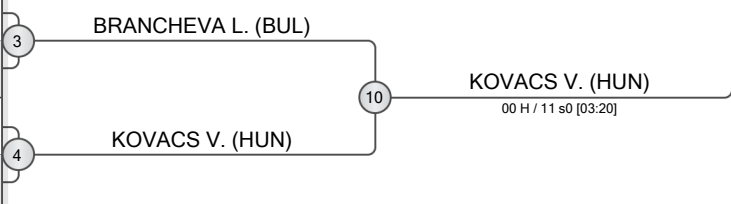

POOL C

	DIOLLOT Juliette	FRA
	JEFTIC Natasa	MNE
	KOWALEWSKA Aleksandra	POL

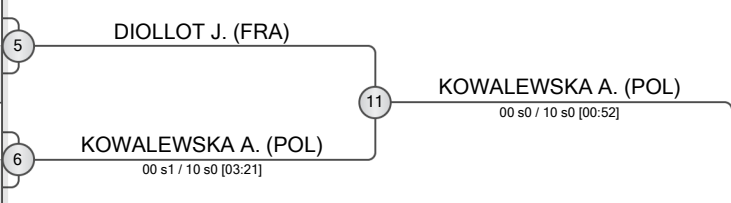

POOL D

	SOULA Florine	FRA
	NARVA Anni-Olivia	FIN

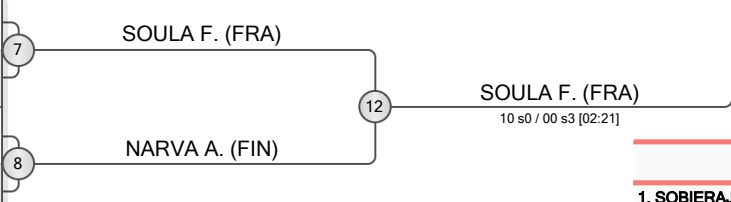

FINAL RESULTS		
1.	SOBIERAJSKA Katarzyna	POL
2.	SOULA Florine	FRA
3.	BRANCHEVA Lidia	BUL
3.	DIOLLOT Juliette	FRA
5.	KOWALEWSKA Aleksandra	POL
5.	KOVACS Viktoria	HUN
7.	MAZOVEC Ursula	SLO
7.	NARVA Anni-Olivia	FIN

REPECHAGE

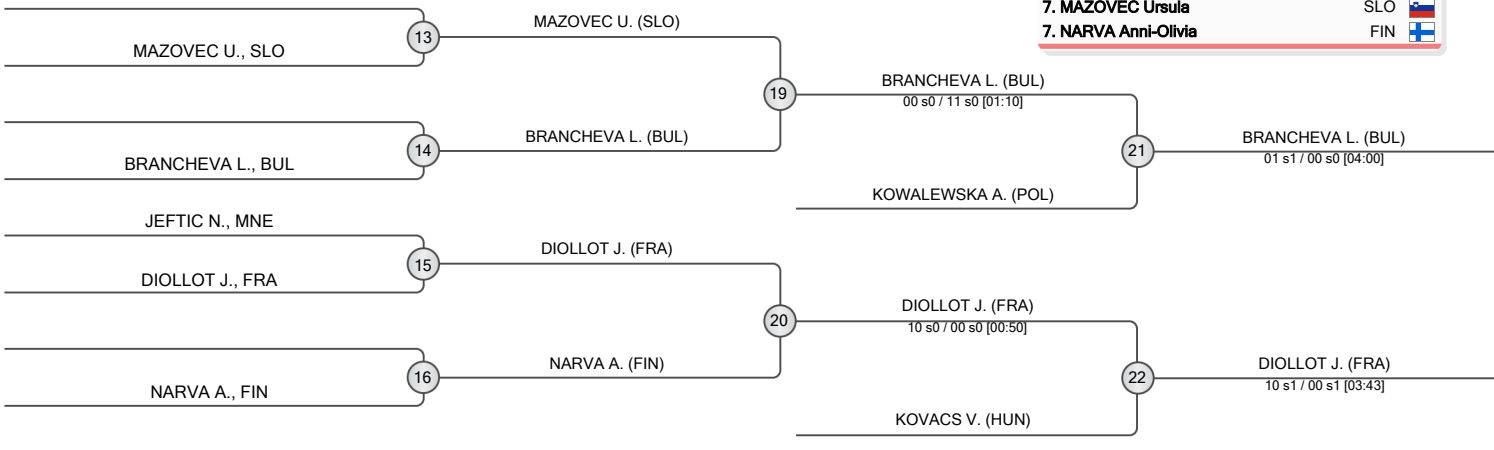

POOL A

	VERSMISSE Lyse	FRA
	SAGI Nikolett	HUN
	KLEINLUGTENBELT Esther	NED

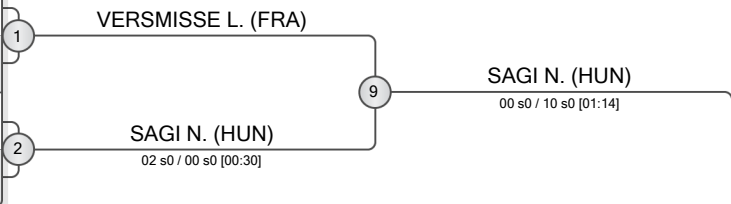

POOL B

	ZATCHI BI Oceane	FRA
	BOUVIER Ilana	FRA

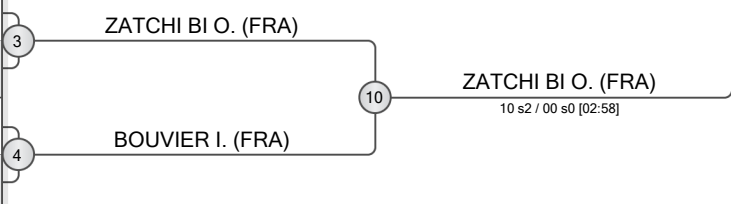

POOL C

	MICHAILIDOU Zanet	CYP
	KRAPU Emma	FIN

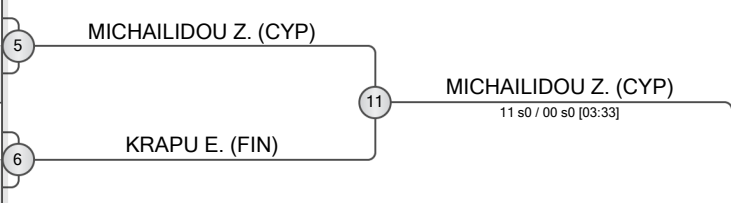

POOL D

	FARKAS Szilvia	HUN
	AMIRLI Narmin	AZE

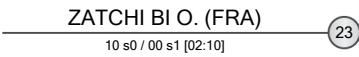
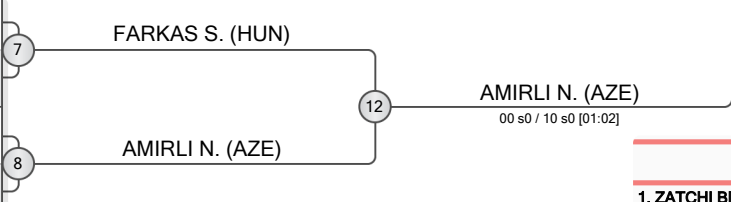

REPECHAGE

KLEINLUGTENBELT E., NED	VERSMISSE L. (FRA)	13
VERSMISSE L., FRA	BOUVIER I. (FRA)	14
BOUVIER I., FRA	KRAPU E. (FIN)	15
KRAPU E., FIN	FARKAS S. (HUN)	16
FARKAS S., HUN		

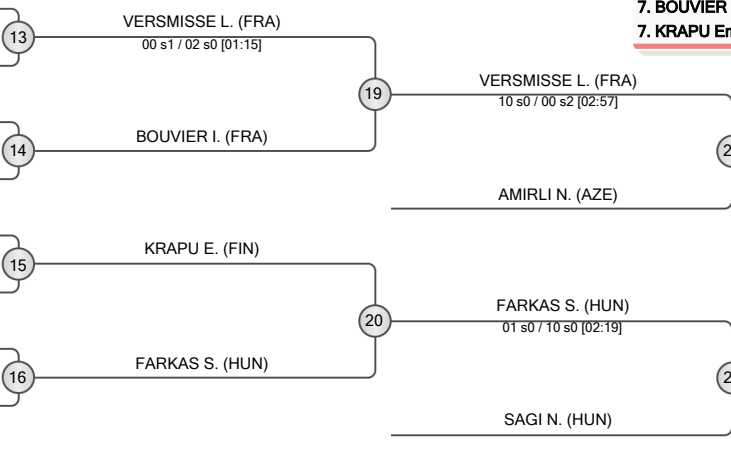

FINAL RESULTS		
1. ZATCHI BI Oceane	FRA	
2. MICHAILIDOU Zanet	CYP	
3. VERSMISSE Lyse	FRA	
3. SAGI Nikolett	HUN	
5. AMIRLI Narmin	AZE	
5. FARKAS Szilvia	HUN	
7. BOUVIER Ilana	FRA	
7. KRAPU Emma	FIN	

Num.	Competitor	State	1	2	3	4	Wins	Points
1.	NACER Dounia	France					3	30
2.	BOGDANOVIC Anastasija	Serbia					0	0
3.	MARIC Sara	Bosnia and Herzegovina					2	20
4.	CHOBOT Klaudia	Poland					1	10

NACER Dounia	FRA	1	NACER D. (FRA)
BOGDANOVIC Anastasija	SRB		
MARIC Sara	BIH	2	MARIC S. (BIH)
CHOBOT Klaudia	POL		

FINAL RESULTS		
1. NACER Dounia	FRA	
2. MARIC Sara	BIH	
3. CHOBOT Klaudia	POL	
4. BOGDANOVIC Anastasija	SRB	

BOGDANOVIC Anastasija	SRB	3	CHOBOT K. (POL)
CHOBOT Klaudia	POL		
MARIC Sara	BIH	4	NACER D. (FRA)
NACER Dounia	FRA		

MARIC Sara	BIH	5	MARIC S. (BIH)
BOGDANOVIC Anastasija	SRB		
NACER Dounia	FRA	6	NACER D. (FRA)
CHOBOT Klaudia	POL		