

-55 kg

11 Judoka

POOL A

1 LAMPREIA, Goncalo POR
9

1 LAMPREIA, G. (POR)

5 TURKMAN, Tuncay TUR
13

2 TURKMAN, Tuncay (TUR)

Pool A - Winner
Vainqueur / Sieger

POOL B

3 AGHASYAN, Vahe ARM
11

3 AGHASYAN, Vahe (ARM)

7 ALIYEV, Murad AZE
15 ERRICHELLO, Davide ITA

4

Pool B - Winner
Vainqueur / Sieger

POOL C

2 LOMITASHVILI, Daviti GEO
10

5 LOMITASHVILI, D. (GEO)

6 ORPHANOU, Daniel FIN
14 TARAN, Maxim MDA

6

Pool C - Winner
Vainqueur / Sieger

POOL D

4 SYNOLD, Raphael FRA
12

7 SYNOLD, Raphael (FRA)

8 SOPINEC, David CZE
16 RUBINSTEIN, Roy ISR

8

Pool D - Winner
Vainqueur / Sieger

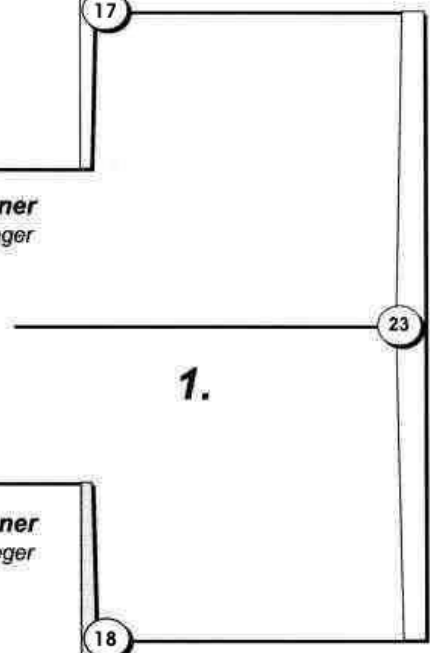

Results	
Résultat / Platzierungen	
1.	
2.	
3.	
3.	
5.	
7.	
7.	

Repechage / Trostrunde

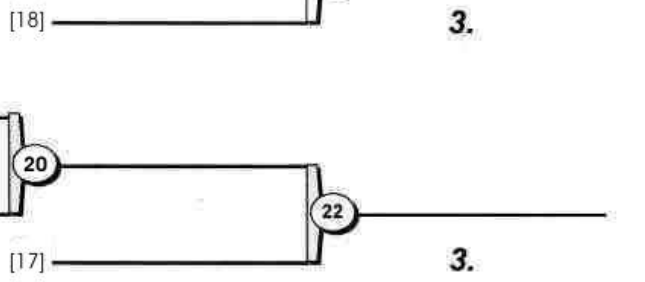
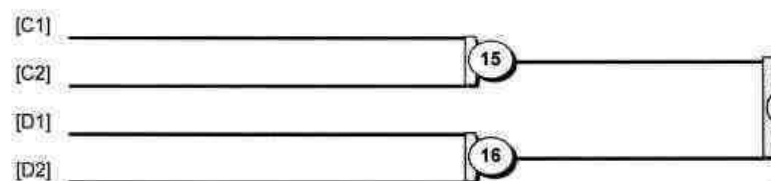
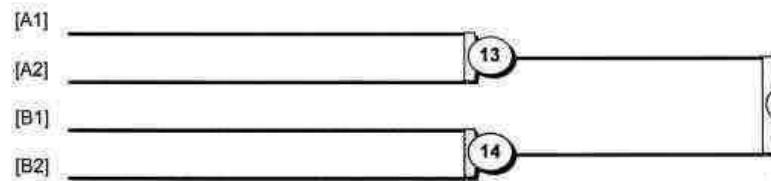

-60 kg
21 Judoka

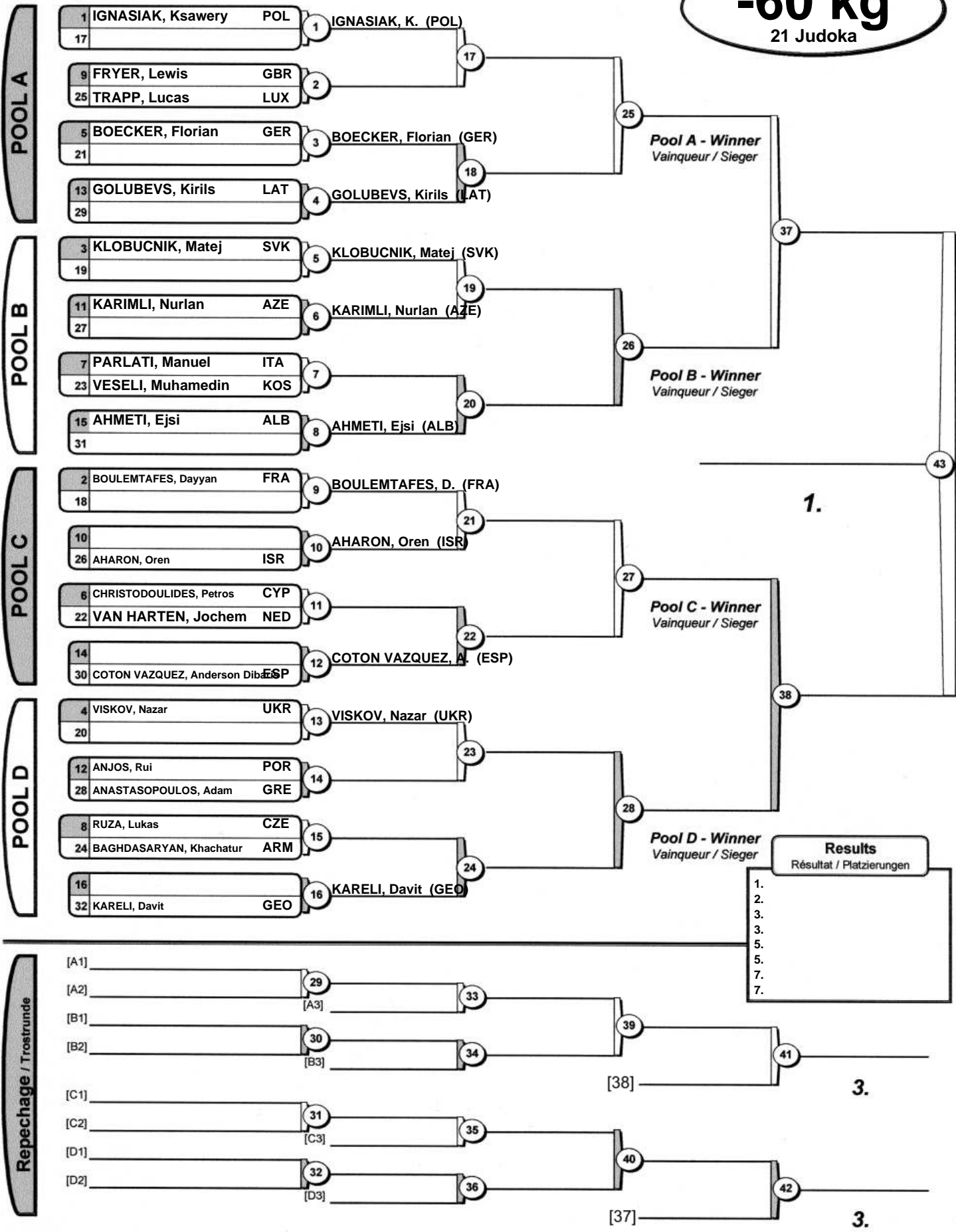

Results	
Résultat / Platzierungen	
1.	
2.	
3.	
3.	
5.	
7.	

-66 kg
26 Judoka

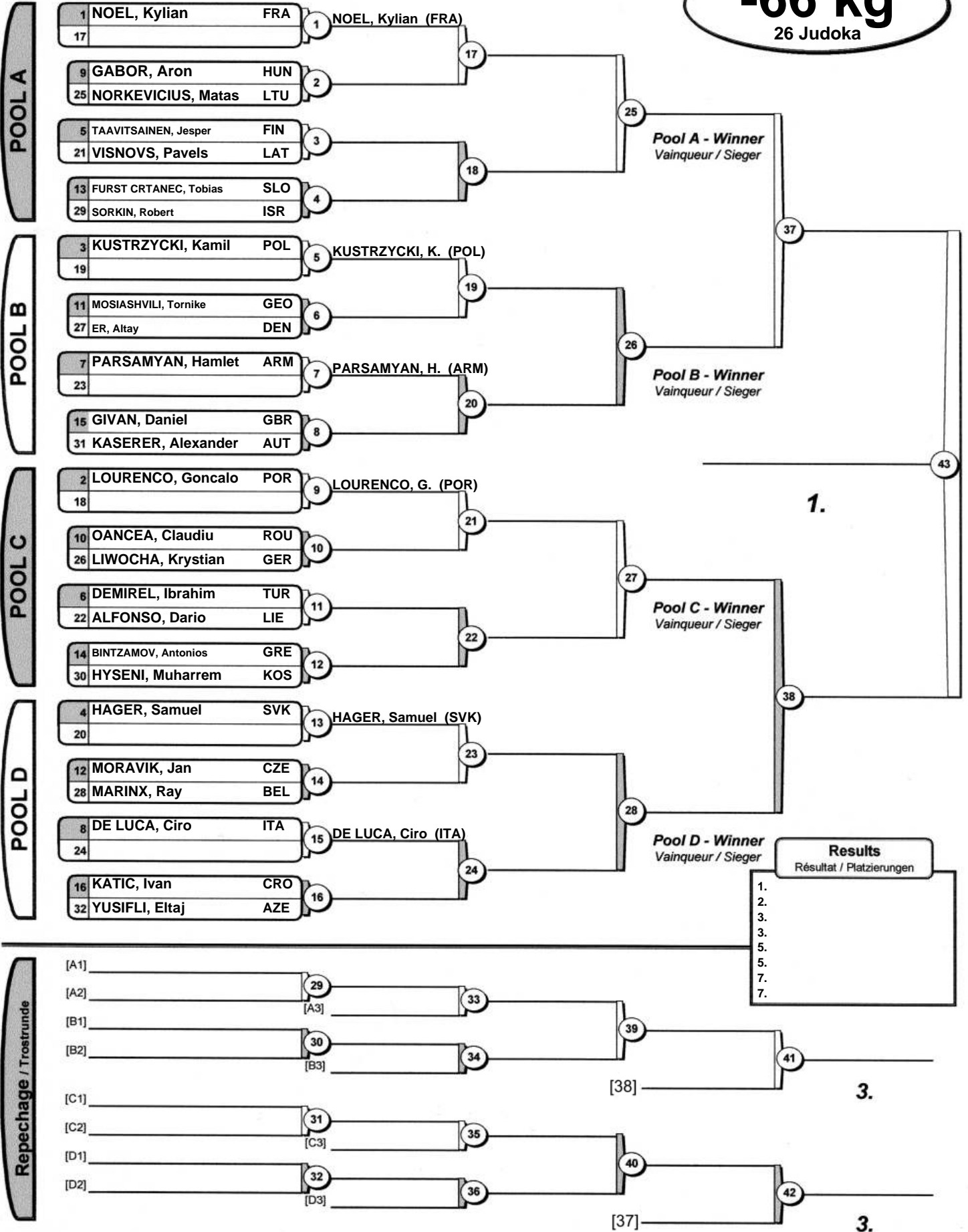

-73 kg
29 Judoka

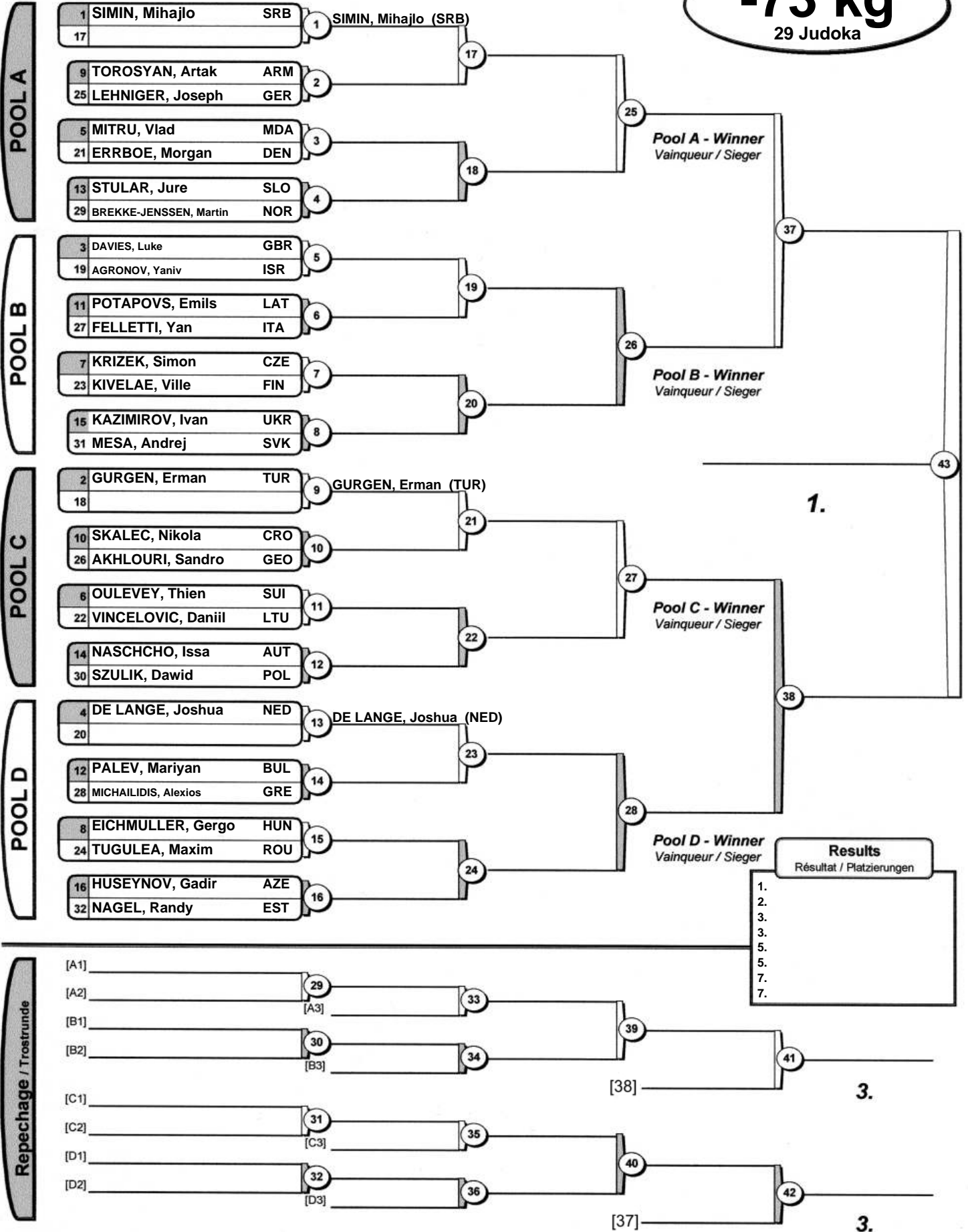

Results	
Résultat / Platzierungen	
1.	
2.	
3.	
3.	
5.	
5.	
7.	
7.	

-81 kg
31 Judoka

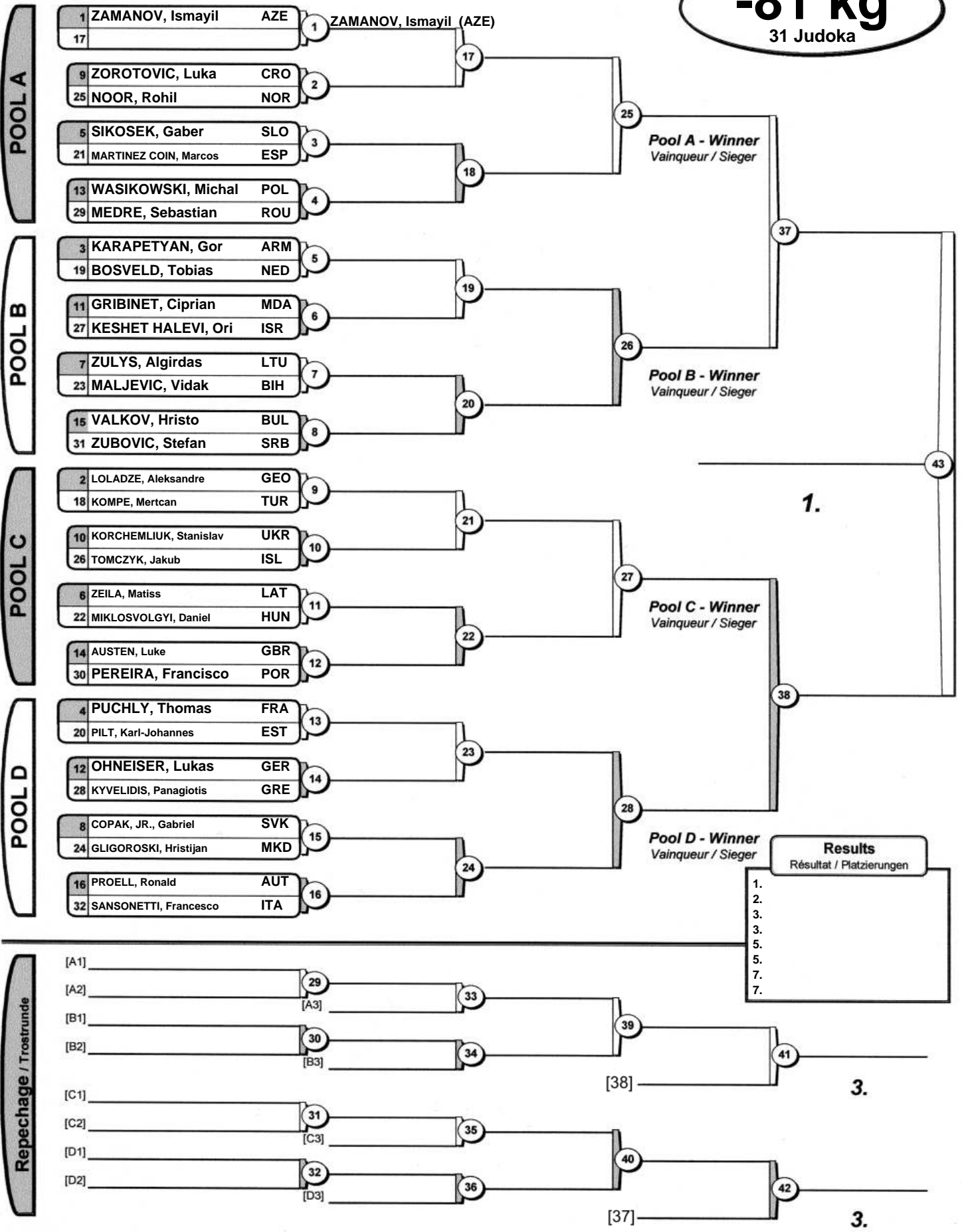

-90 kg
24 Judoka

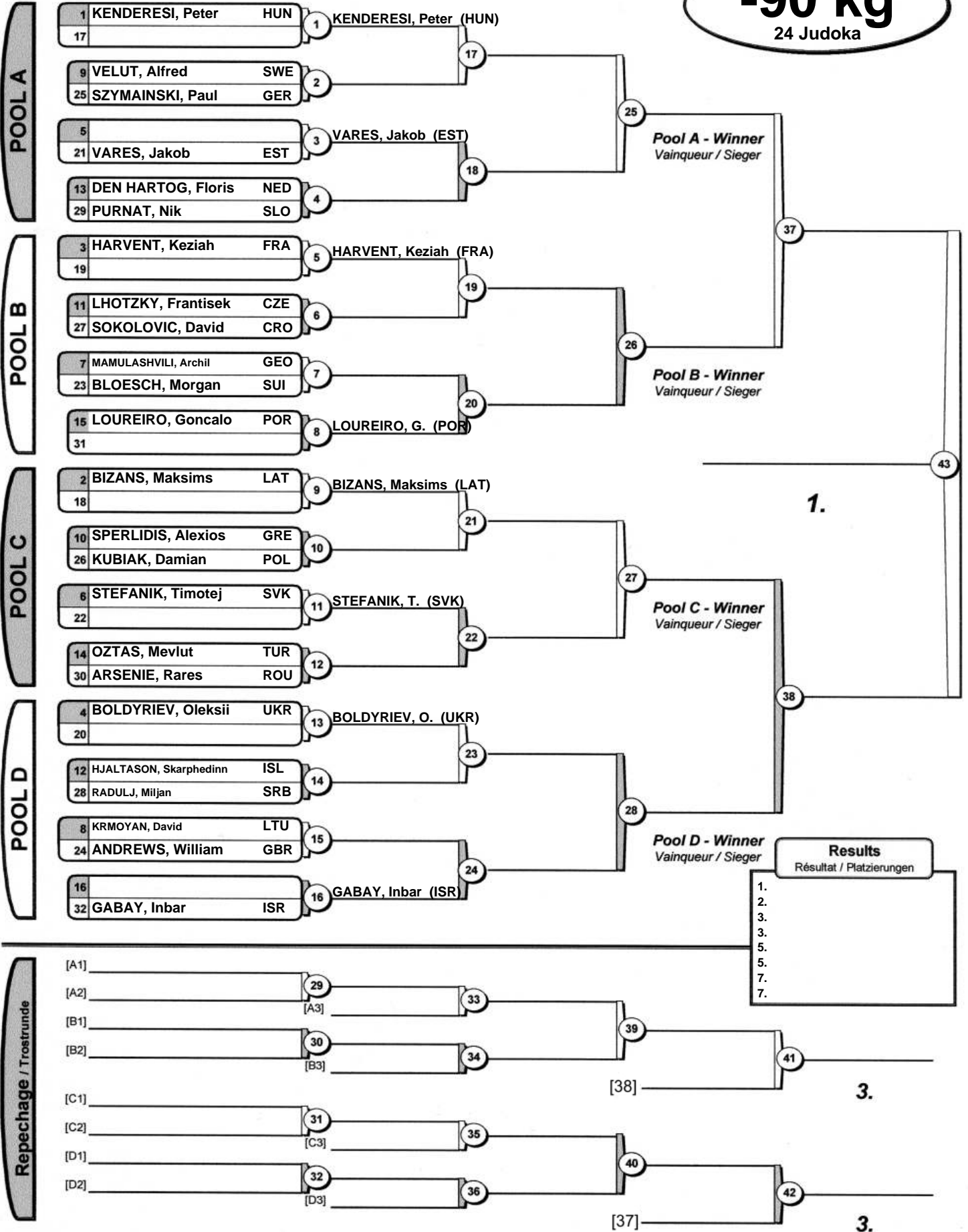

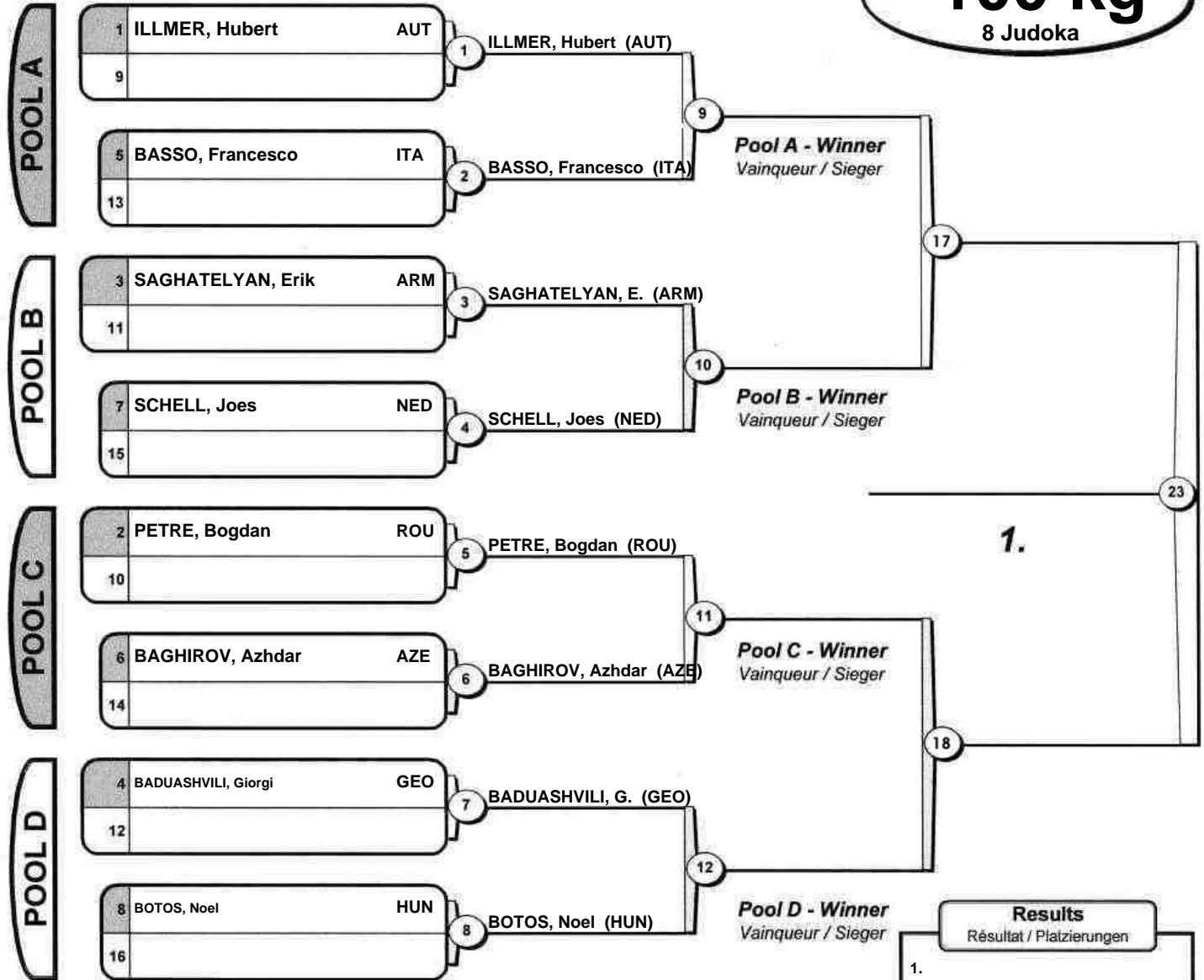

Results	
Résultat / Platzierungen	
1.	
2.	
3.	
3.	
5.	
5.	
7.	
7.	

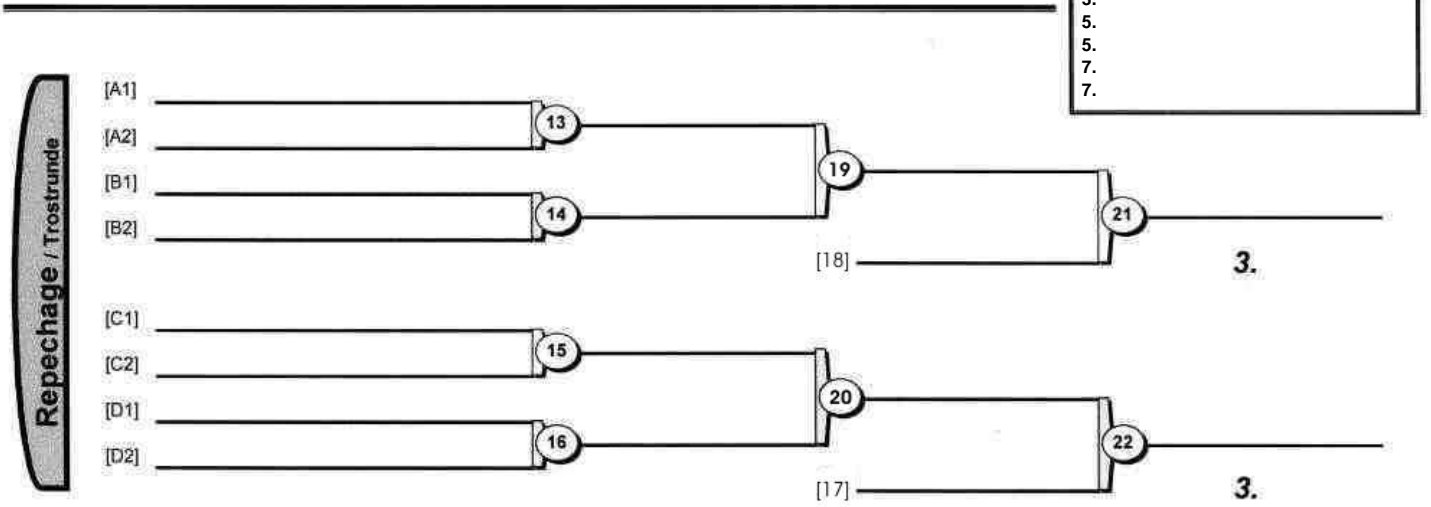

+100 kg
18 Judoka

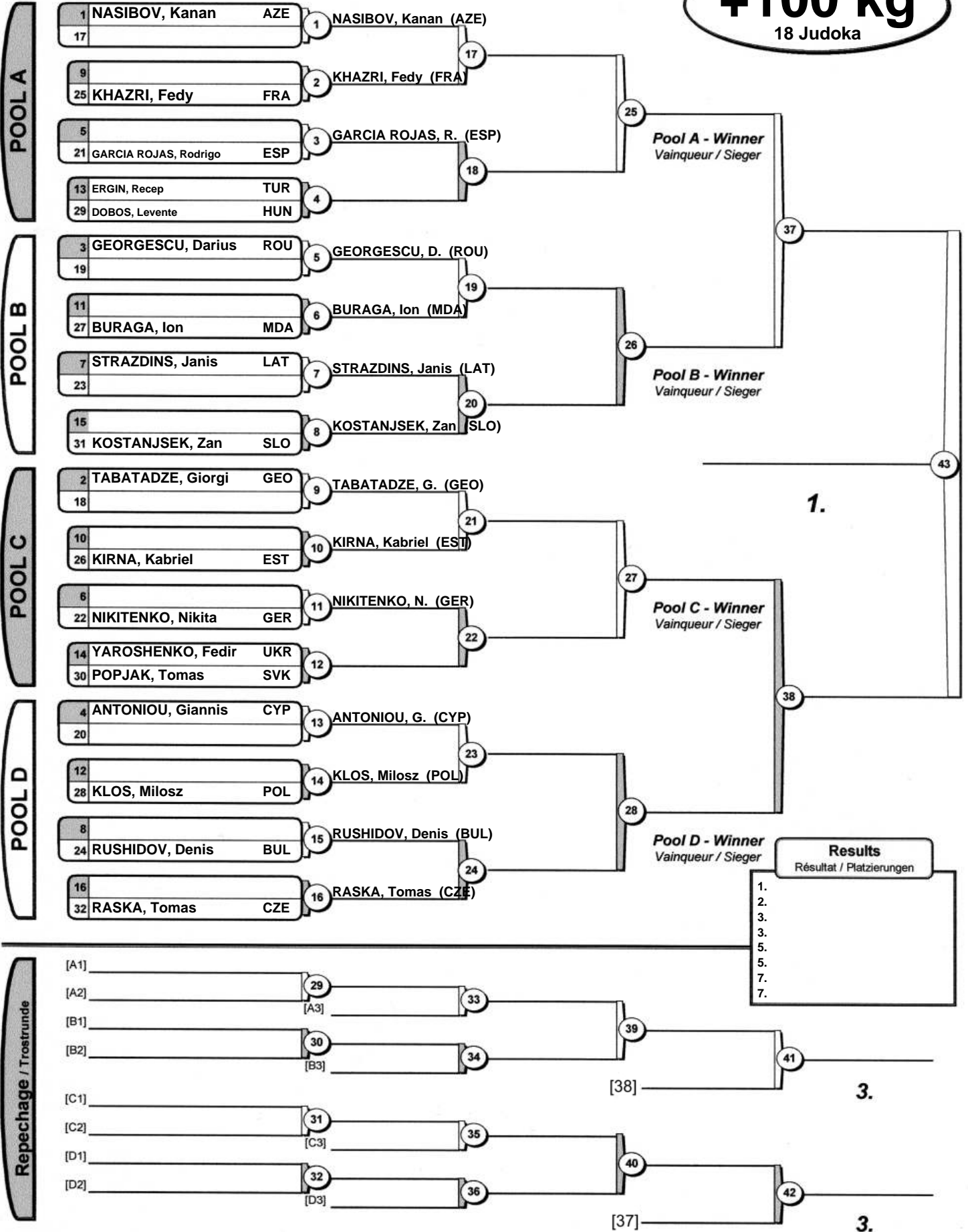

-44 kg
8 Judoka

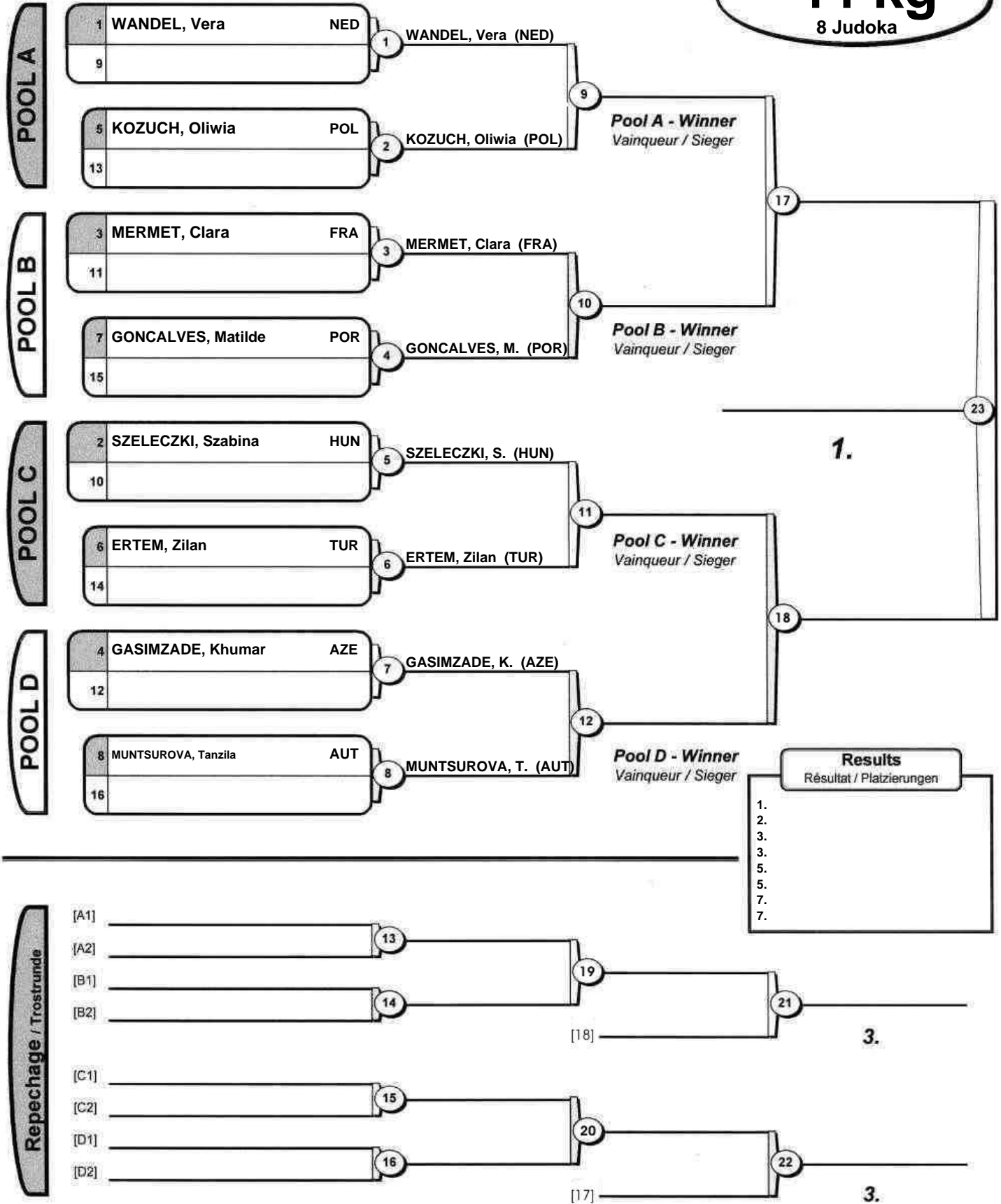

-48 kg
12 Judoka

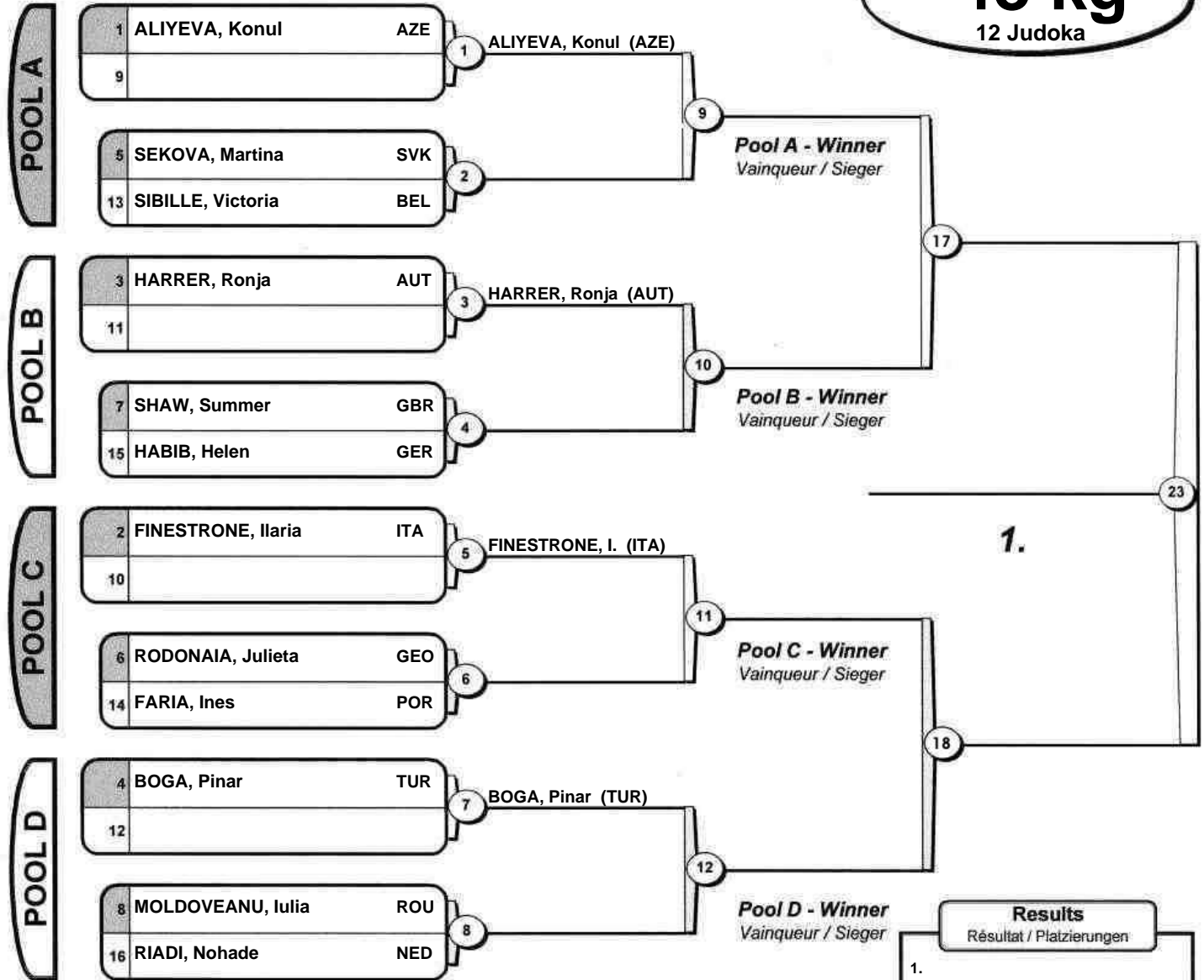

Results	
Résultat / Platzierungen	
1.	
2.	
3.	
3.	
5.	
7.	
7.	

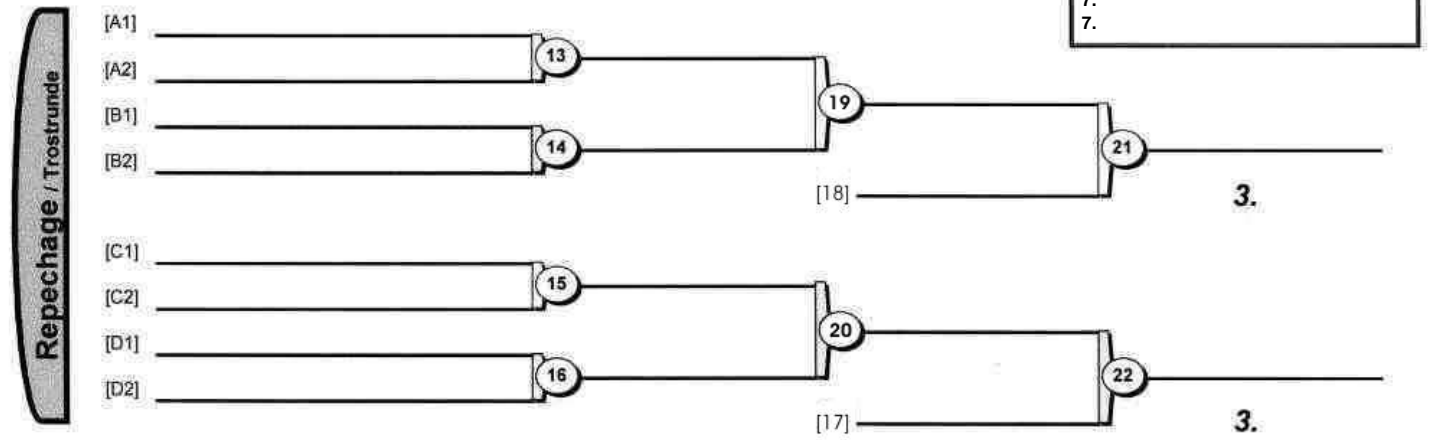

-52 kg
24 Judoka

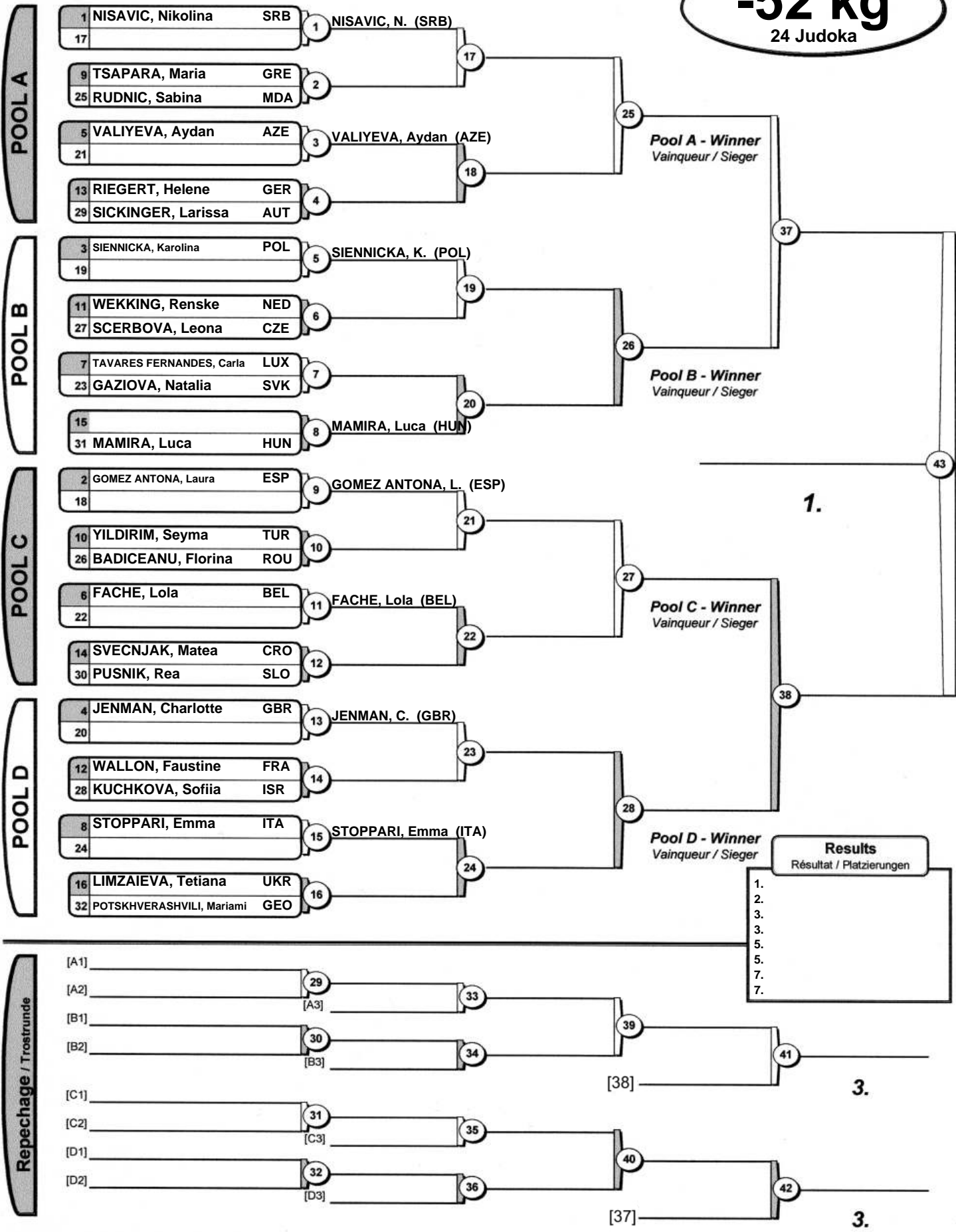

-57 kg
21 Judoka

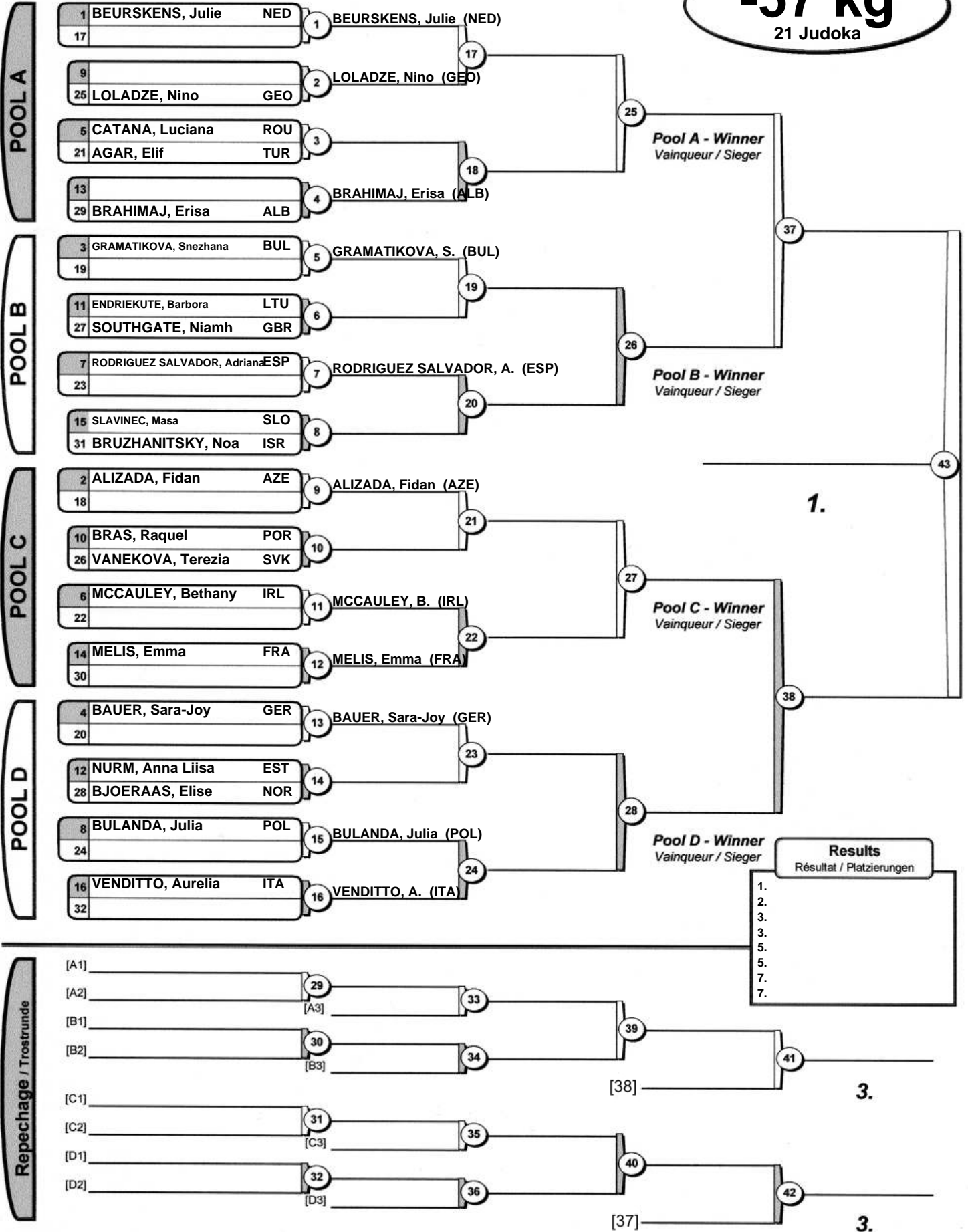

-63 kg
23 Judoka

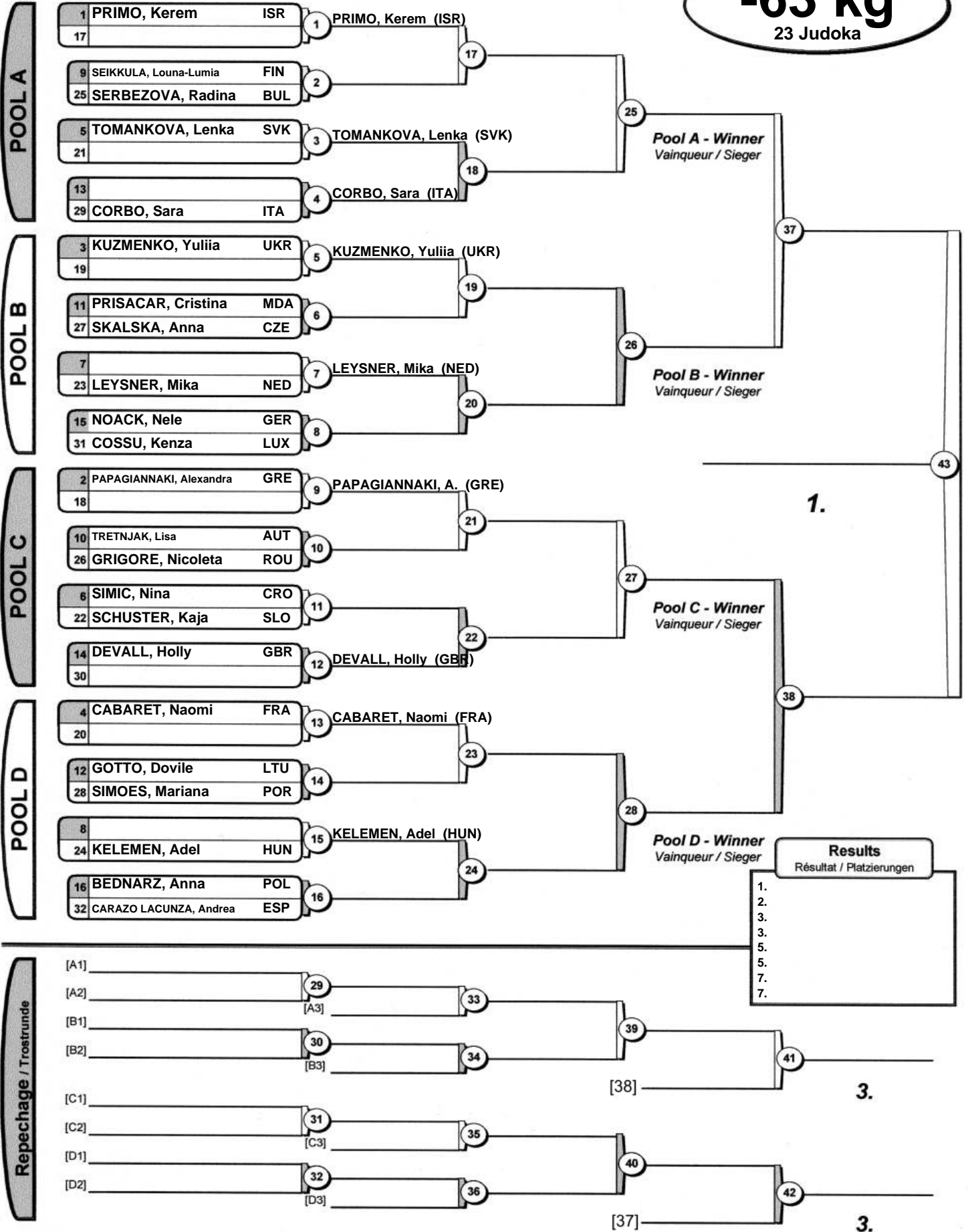

-70 kg
21 Judoka

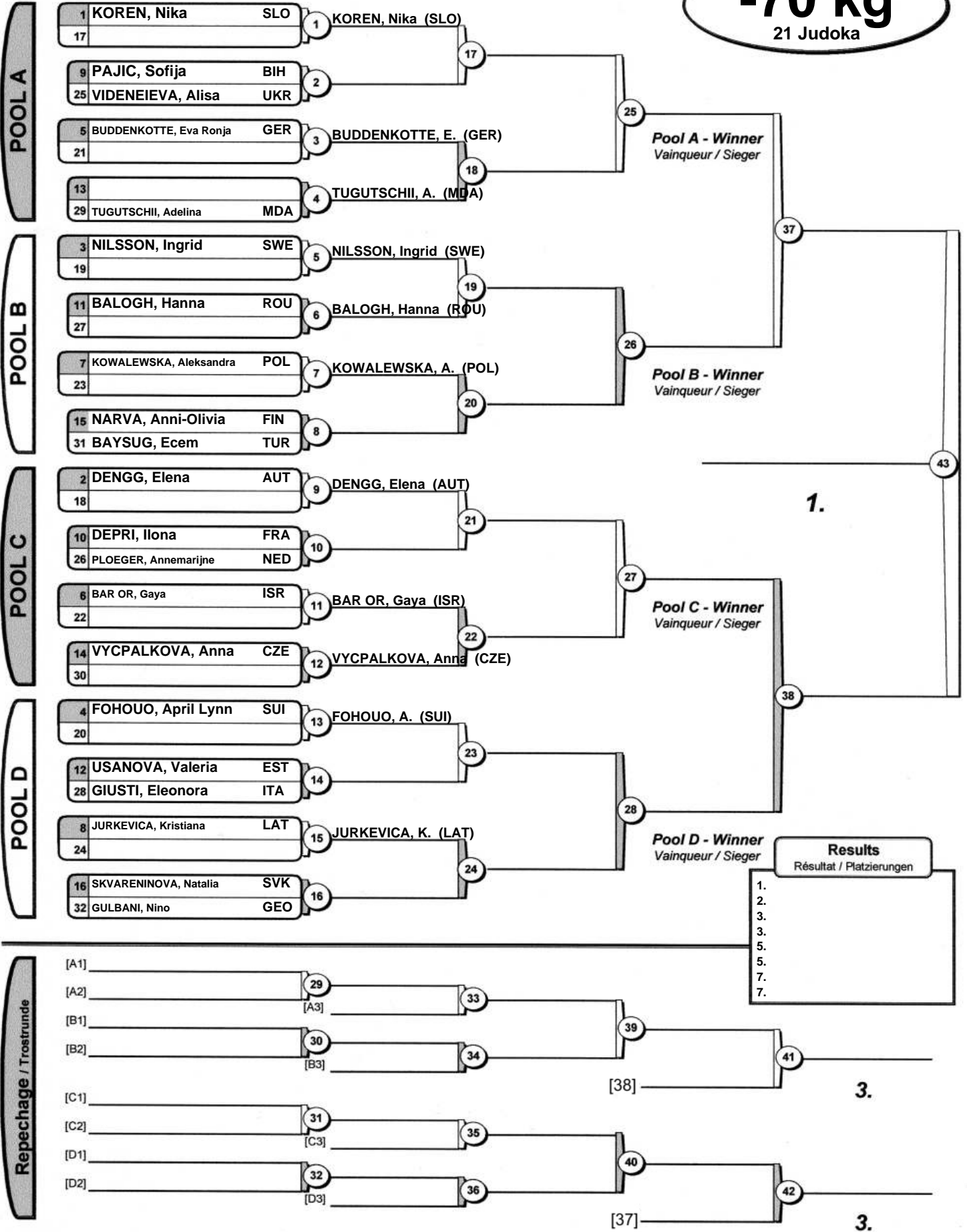

POOL A

1	LYTVYENENKO, Yelyzaveta	UKR	1	LYTVYENENKO, Y. (UKR)
9				

5	LUBURA, Lana	BIH	2	Pool A - Winner Vainqueur / Sieger
13	NIEMEYER, Mathilda Sophie	GER		

POOL B

3	HERIC, Vanessa Asja	SLO	3	Pool B - Winner Vainqueur / Sieger
11	MICHAILIDOU, Eleni	GRE		

7	CONCEICAO, Fabia	POR	4	Pool B - Winner Vainqueur / Sieger
15	PETKOVA, Veronika	BUL		

POOL C

2	MISHINER, Yuli Alma	ISR	5	Pool C - Winner Vainqueur / Sieger
10	KAYA, Sumeyye	TUR		

6	CORNELIU, Francesca	ROU	6	Pool C - Winner Vainqueur / Sieger
14	OMERKOYLU, Jade	NED		

POOL D

4	STJEPANOVIC, Jovana	SRB	7	Pool D - Winner Vainqueur / Sieger
12	HASSAN, Anya	GBR		

8	SAGI, Nikolett	HUN	8	Pool D - Winner Vainqueur / Sieger
16	KRAPU, Emma	FIN		

1.

Results
Résultat / Platzierungen

- 1.
- 2.
- 3.
- 3.
- 5.
- 7.
- 7.

Repechage / Trostrunde

[A1]		13	19	21	3.
[A2]					
[B1]		14	18	21	3.
[B2]					

[C1]		15	20	22	3.
[C2]					
[D1]		16	17	22	3.
[D2]					

	1	3	5	Wins Score	
1 DE PAOLI, Morgana ITA				0 0	
3 LANG, Bintibe FRA				0 0	
5 SULEYMANOVA, Nigar AZE				0 0	

	2	4	Wins	Scores
2 SEMCHENKO, Diana UKR				(0)
4 VRANJES, Marcelina CRO				(0)

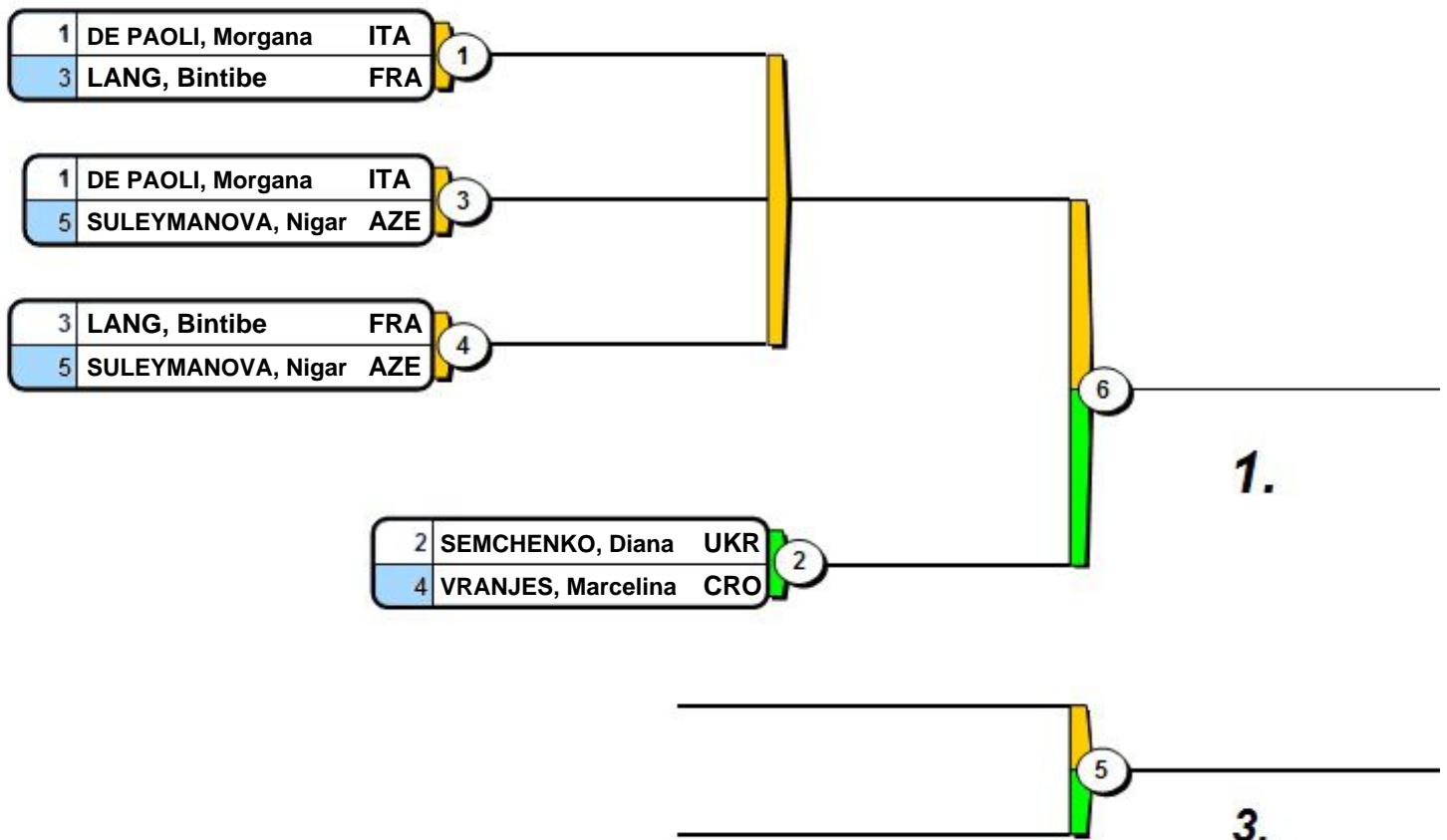

Final Results

- 1.
- 2.
- 3.