

-55 kg
11 Judoka

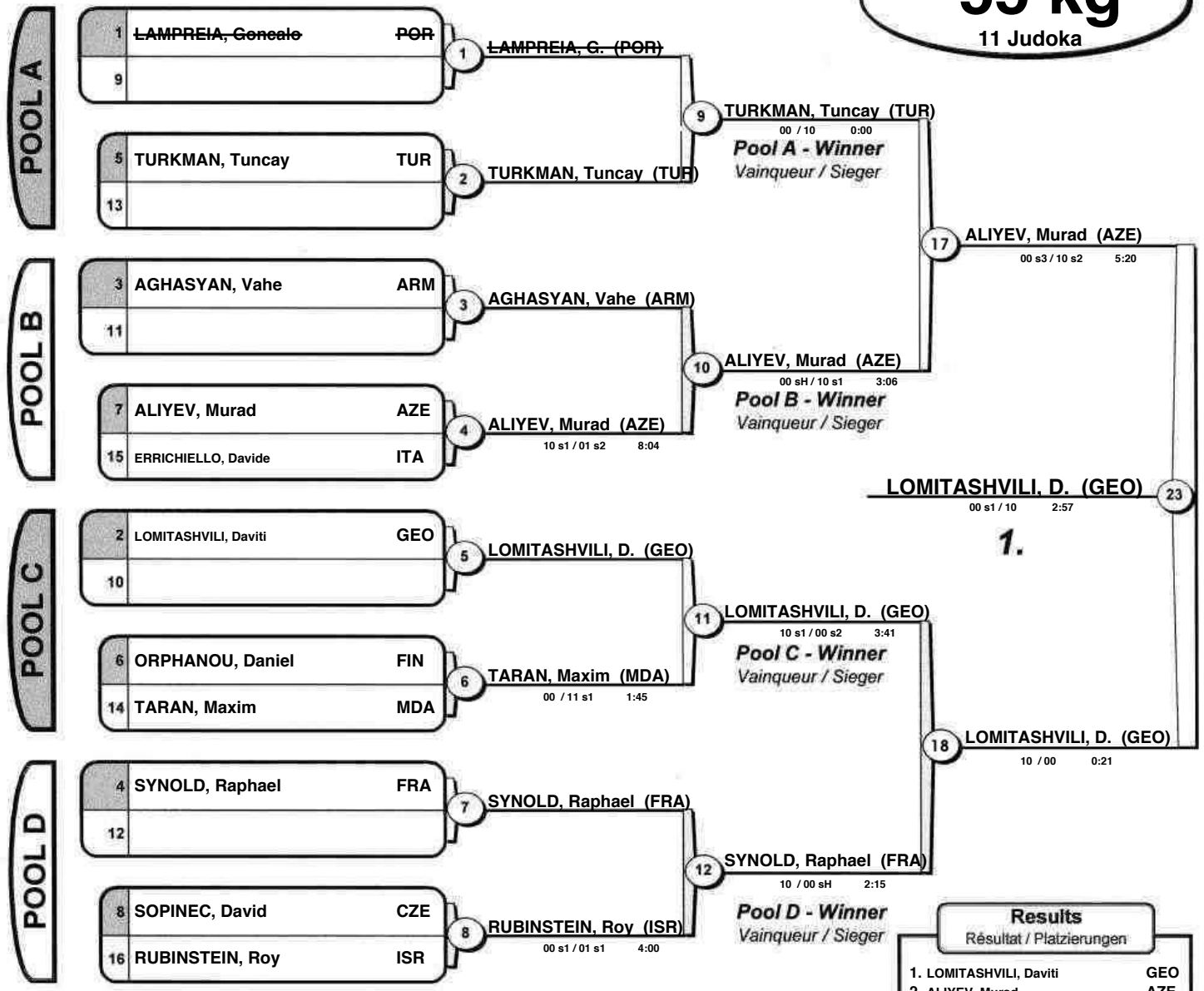

Results	
Résultat / Platzierungen	
1.	LOMITASHVILI, Daviti GEO
2.	ALIYEV, Murad AZE
3.	AGHASYAN, Vahe ARM
5.	RUBINSTEIN, Roy ISR
5.	SYNOLD, Raphael FRA
5.	TURKMAN, Tuncay TUR
7.	LAMPREIA, Goncalo POR
7.	TARAN, Maxim MDA

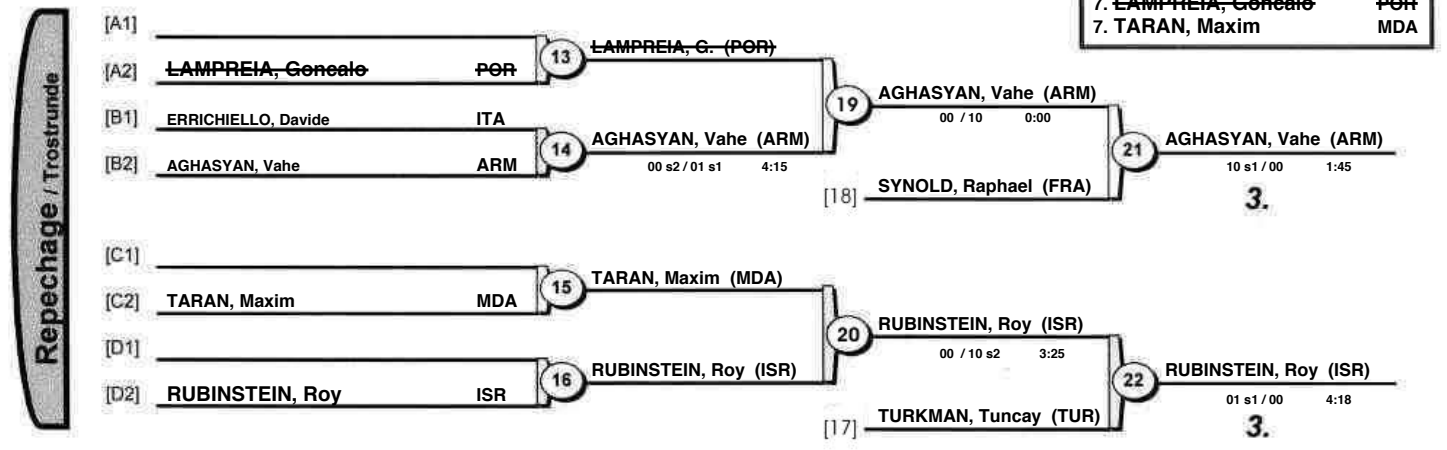

-60 kg
21 Judoka

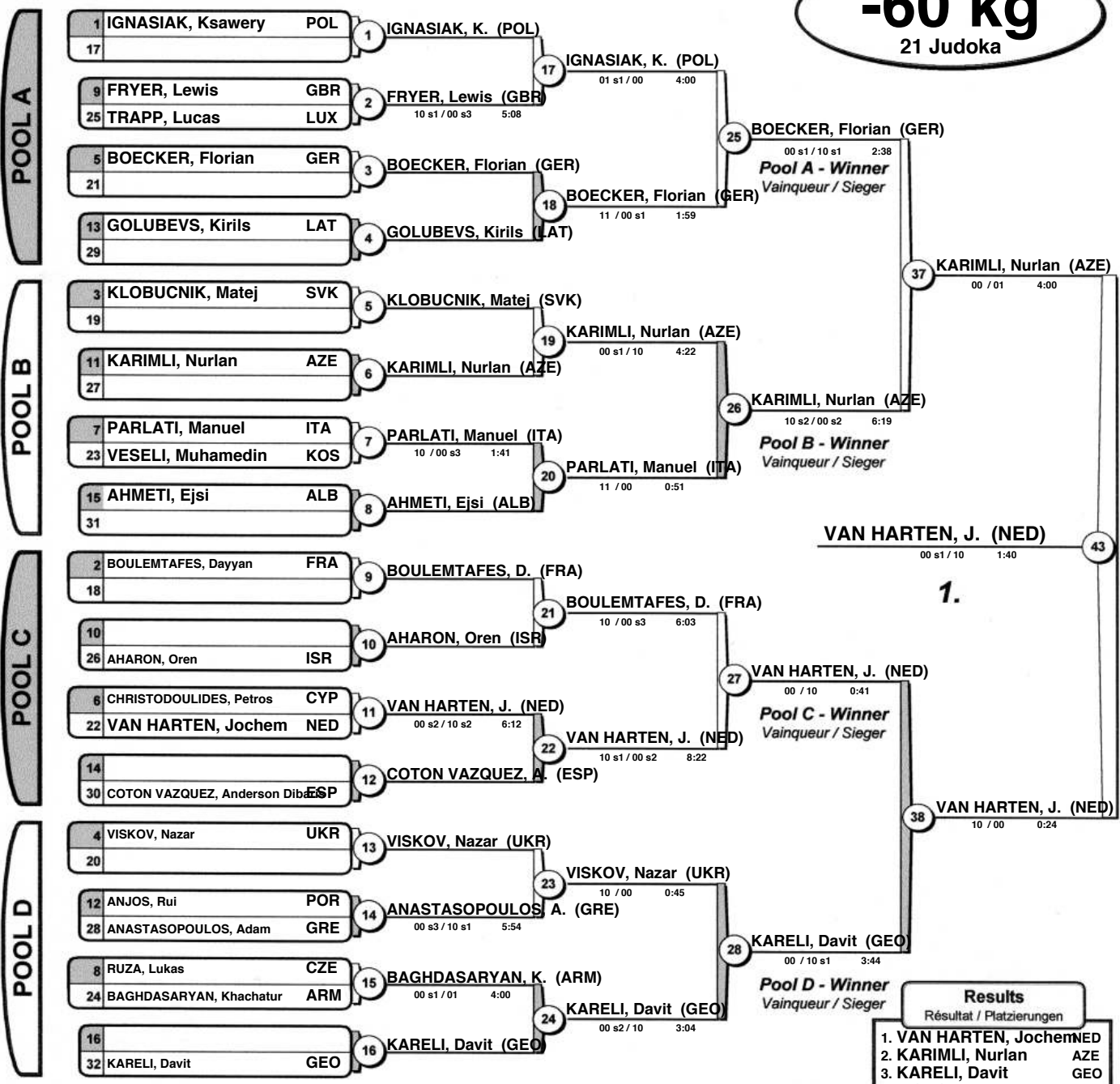

Results
Résultat / Platzierungen

1. VAN HARTEN, Jochem (NED)
2. KARIMLI, Nurlan (AZE)
3. KARELI, Davit (GEO)
3. VISOVKOV, Nazar (UKR)
5. PARLATI, Manuel (ITA)
5. BOECKER, Florian (GER)
7. IGNASIAK, Ksavery (POL)
7. COTON VAZQUEZ, Anderson Diba (ESP)

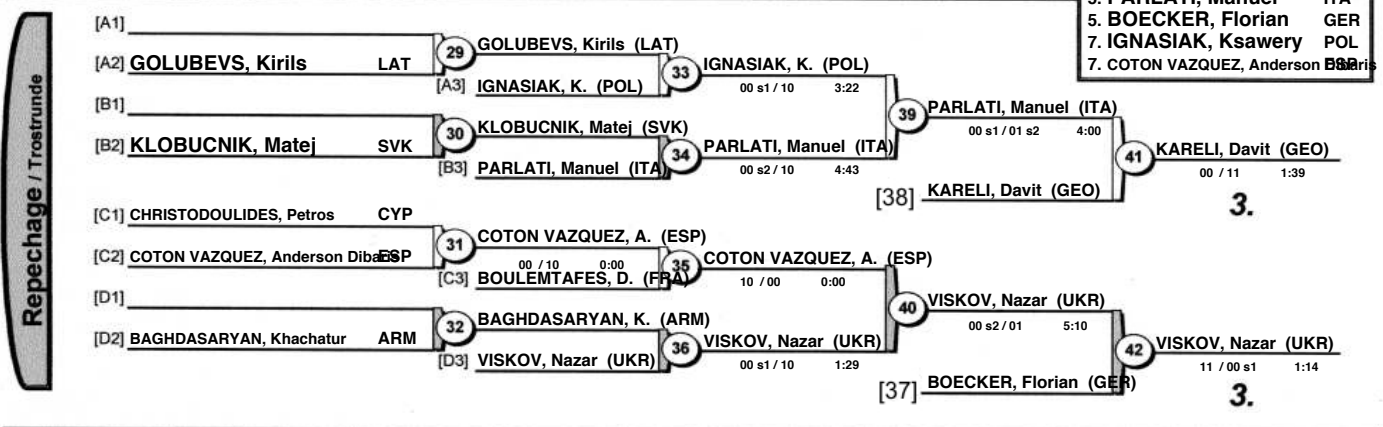

-66 kg
26 Judoka

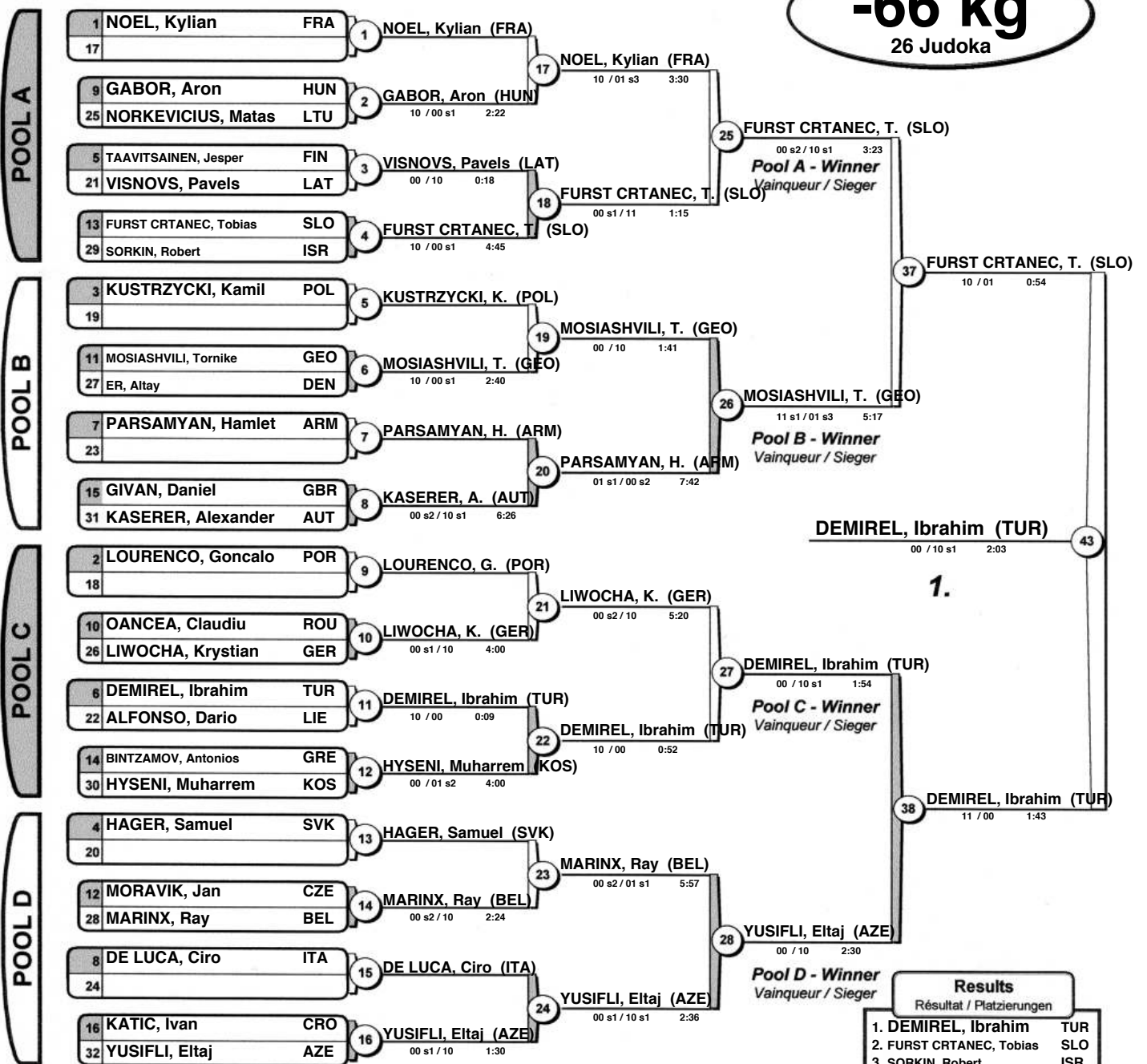

Results
Résultat / Platzierungen

1.	DEMIREL, Ibrahim	TUR
2.	FURST CRTANEC, Tobias	SLO
3.	SORKIN, Robert	ISR
5.	YUSIFLI, Eltaj	AZE
5.	MARINX, Ray	BEL
7.	ER, Altay	DEN
7.	LIWOCHA, Krystian	GER

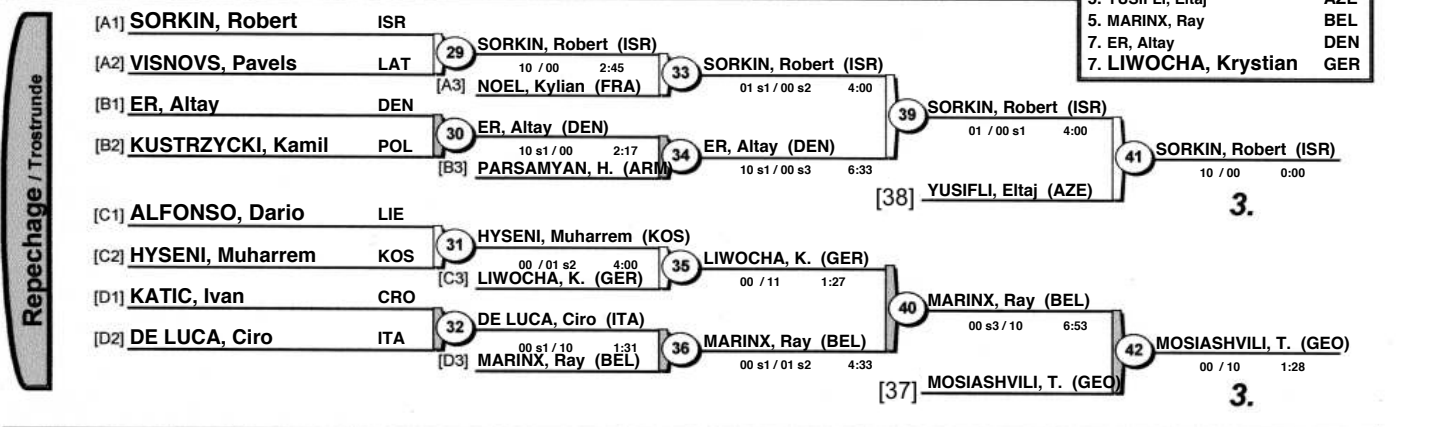

-73 kg
29 Judoka

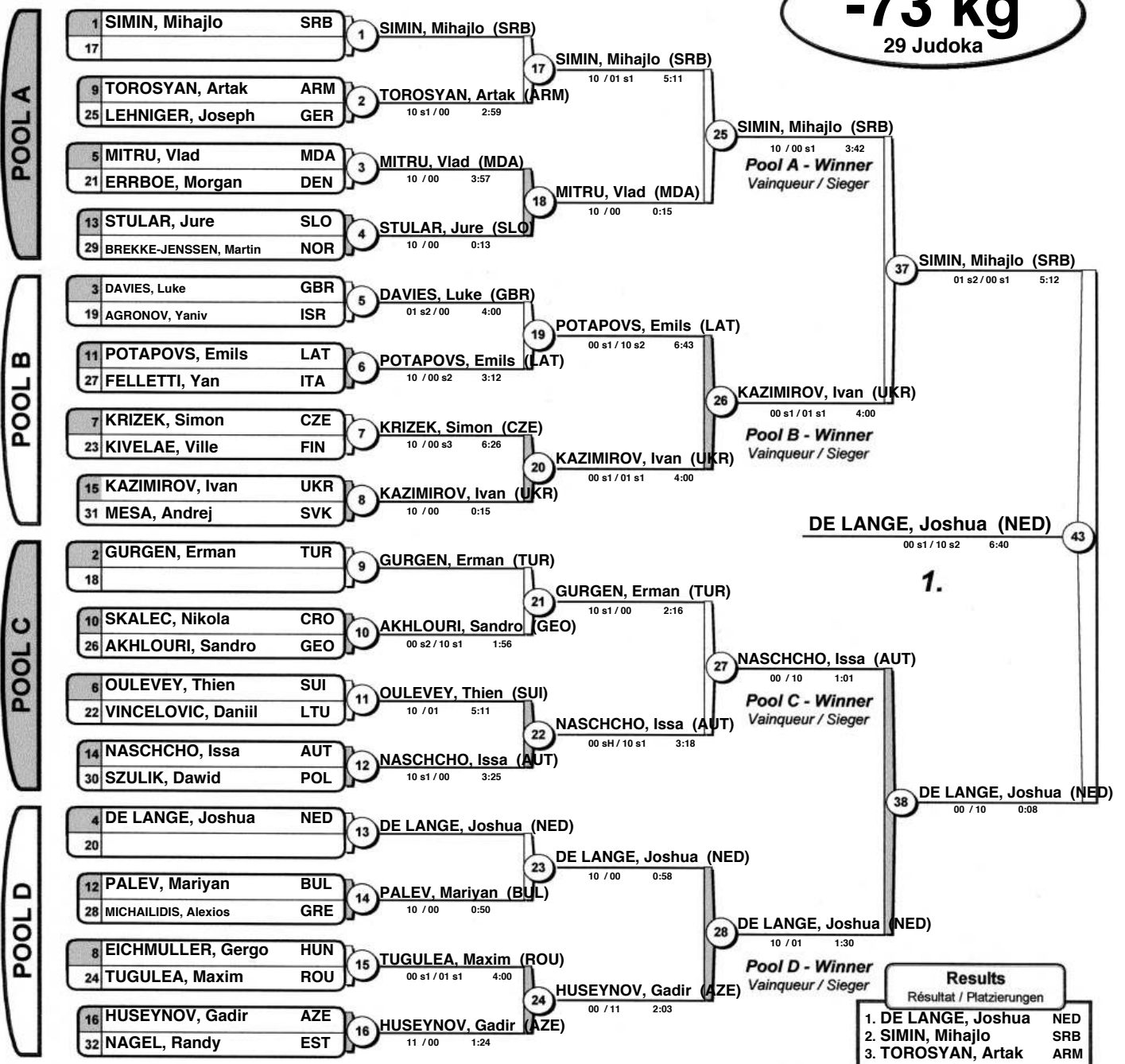

Results	
Résultat / Platzierungen	
1.	DE LANGE, Joshua NED
2.	SIMIN, Mihajlo SRB
3.	TOROSYAN, Artak ARM
3.	KAZIMIROV, Ivan UKR
5.	NASCHCHO, Issa AUT
7.	PALEV, Mariyan BUL
7.	KRIZEK, Simon CZE
7.	GURGEN, Erman TUR

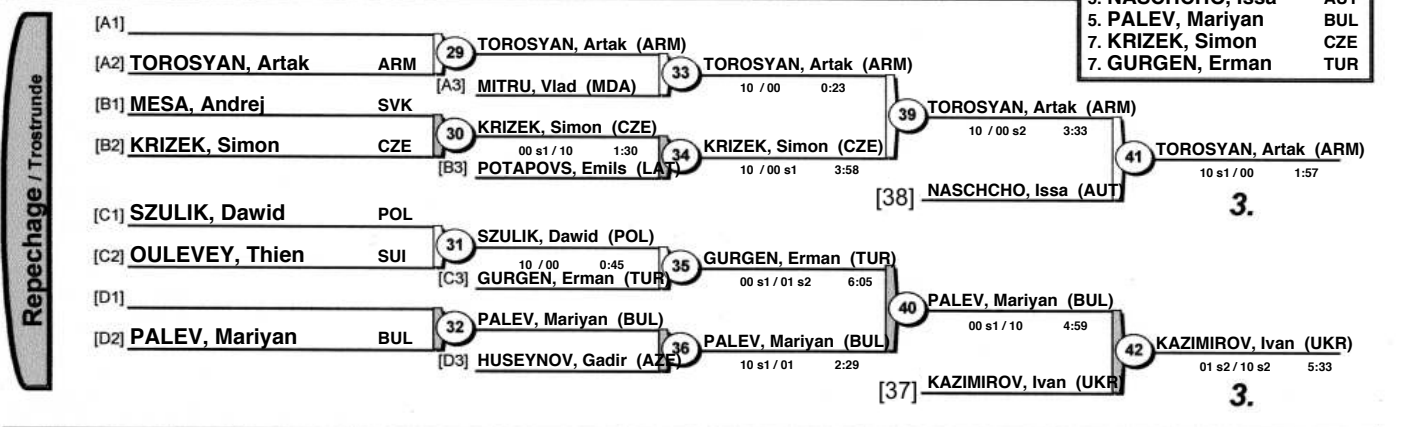

-81 kg
31 Judoka

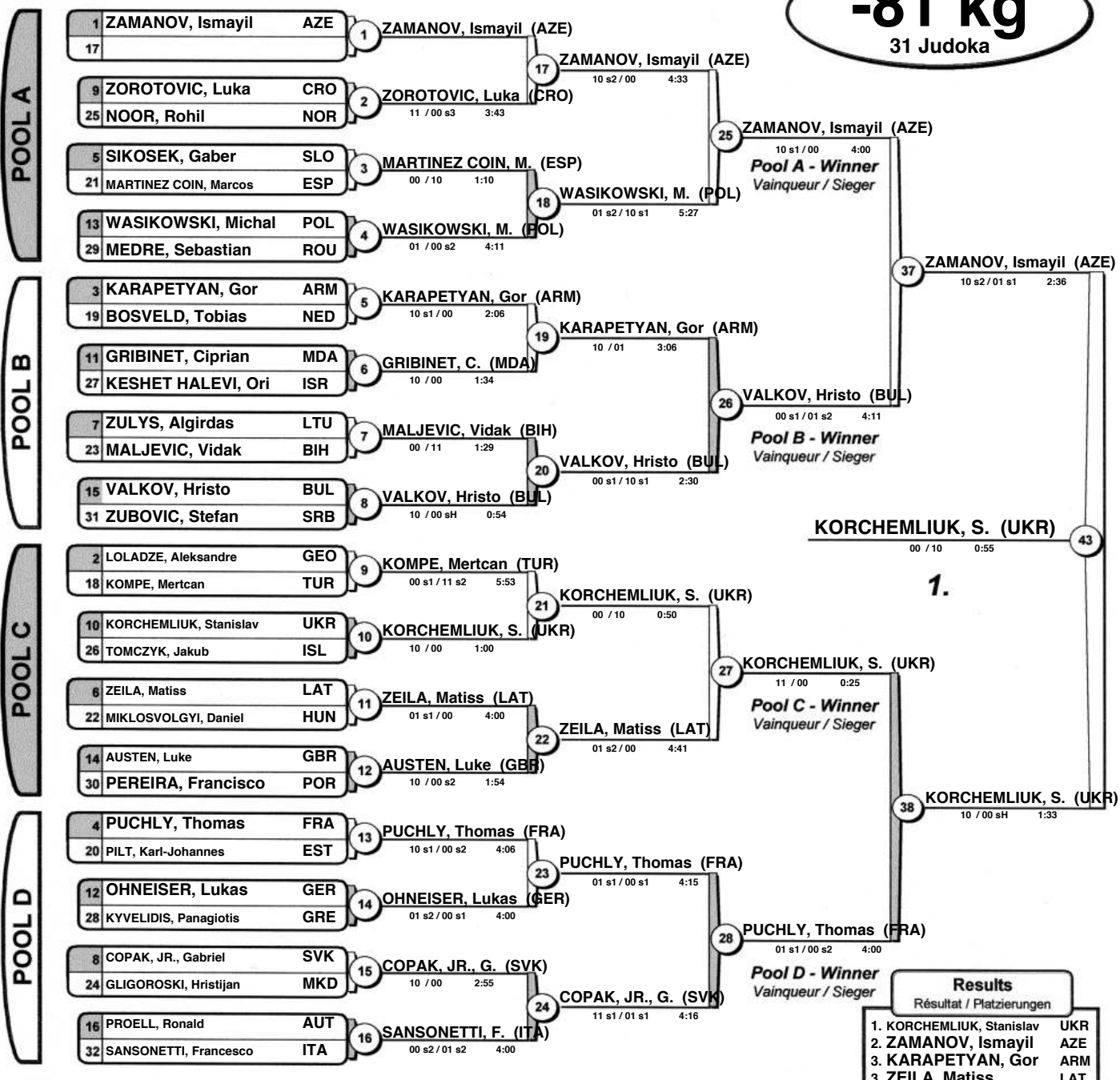

Results	
Résultat / Platzierungen	
1.	KORCHEMLIUK, Stanislav UKR
2.	ZAMANOV, Ismayil AZE
3.	KARAPETYAN, Gor ARM
3.	ZEILA, Matiss LAT
5.	PUCHLY, Thomas FRA
6.	VALKOV, Hristo BUL
7.	ZOROTOVIC, Luka CRO
7.	PILT, Karl-Johannes EST

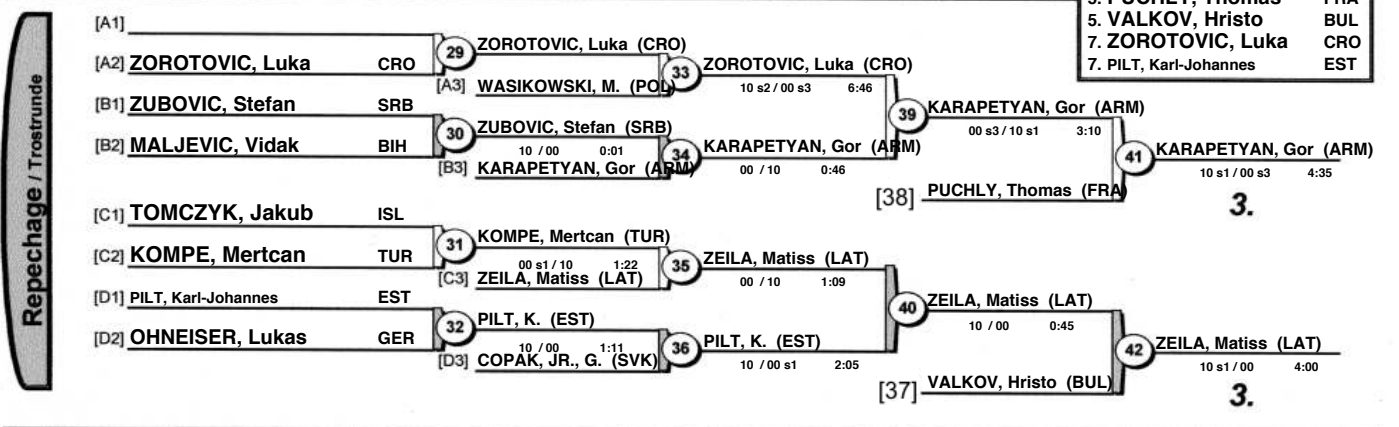

+100 kg
18 Judoka

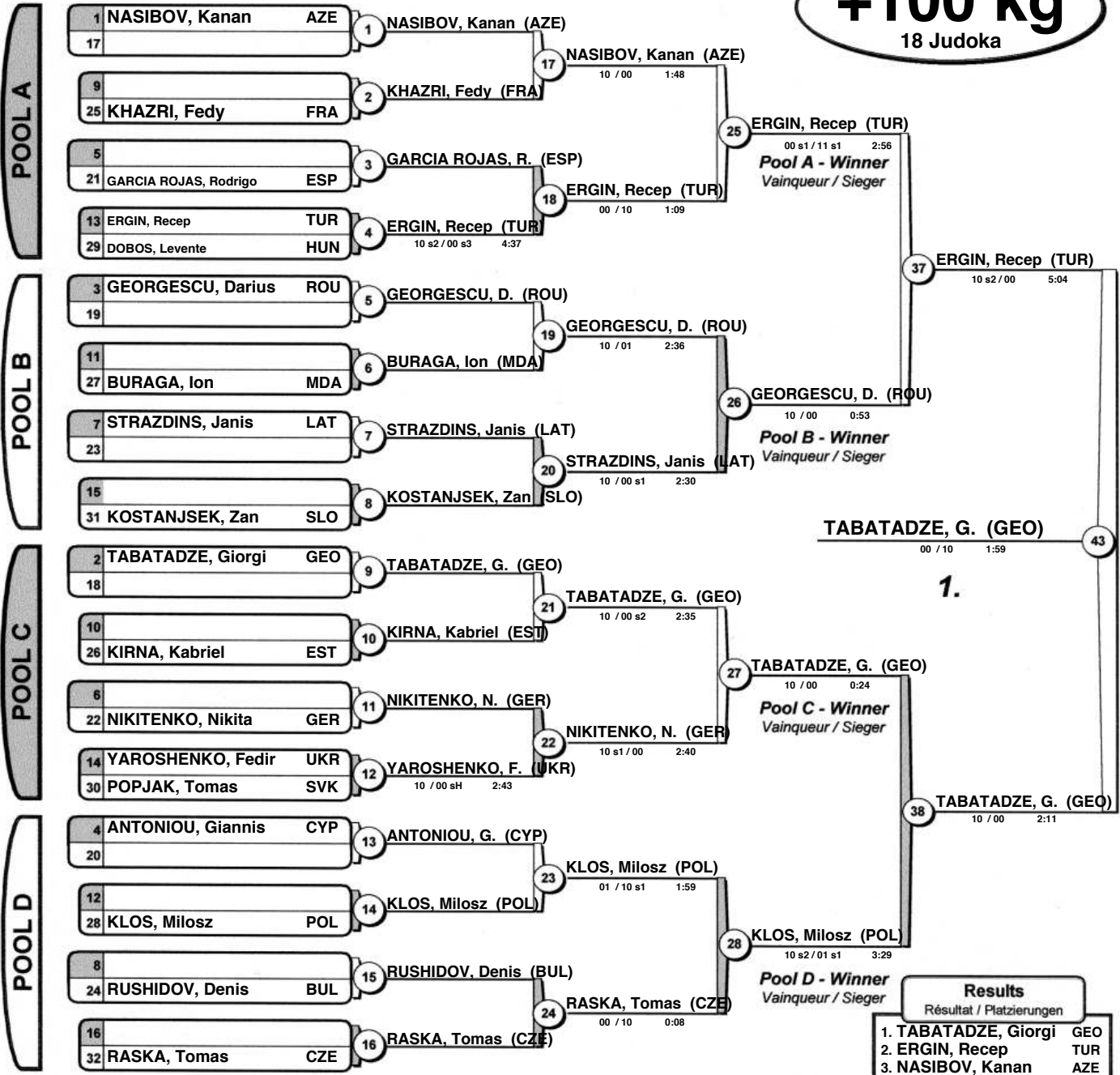

Results		
Résultat / Platzierungen		
1.	TABATADZE, Giorgi	GEO
2.	ERGIN, Recep	TUR
3.	NASIBOV, Kanan	AZE
3.	ANTONIOU, Giannis	CYP
5.	KLOS, Milosz	POL
5.	GEORGESCU, Darius	ROU
7.	STRAZDINS, Janis	LAT
7.	NIKITENKO, Nikita	GER

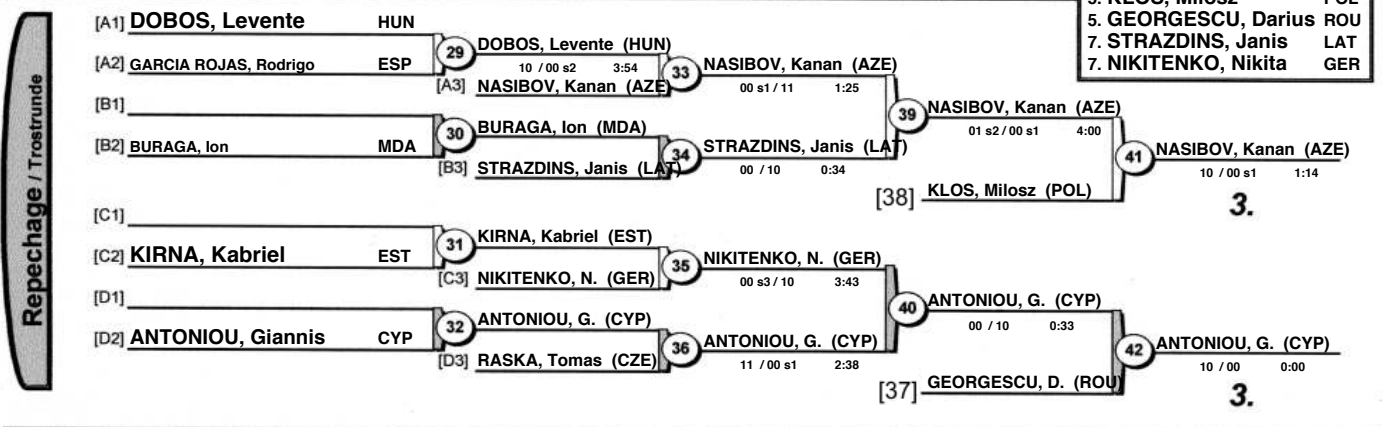

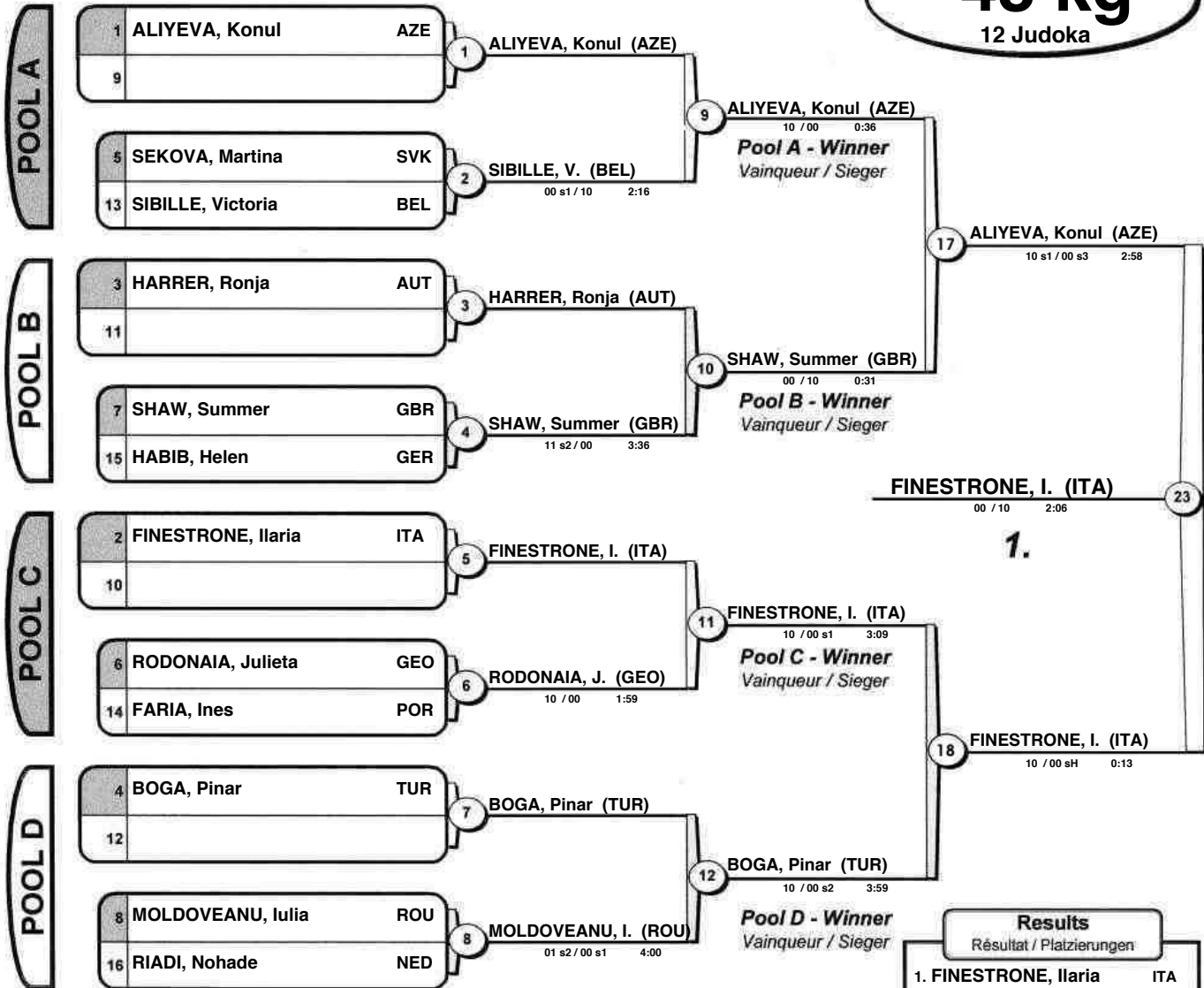

Results		
Résultat / Platzierungen		
1.	FINESTRONE, Ilaria	ITA
2.	ALIYEVA, Konul	AZE
3.	HABIB, Helen	GER
3.	SHAW, Summer	GBR
5.	BOGA, Pinar	TUR
5.	RODONAIA, Julieta	GEO
7.	SIBILLE, Victoria	BEL
7.	MOLDOVEANU, Iulia	ROU

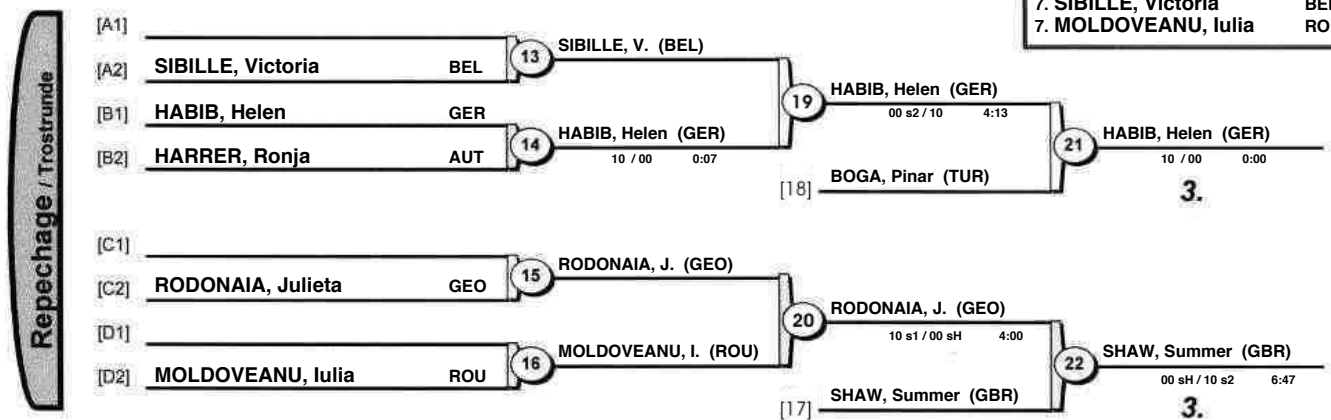

-52 kg
24 Judoka

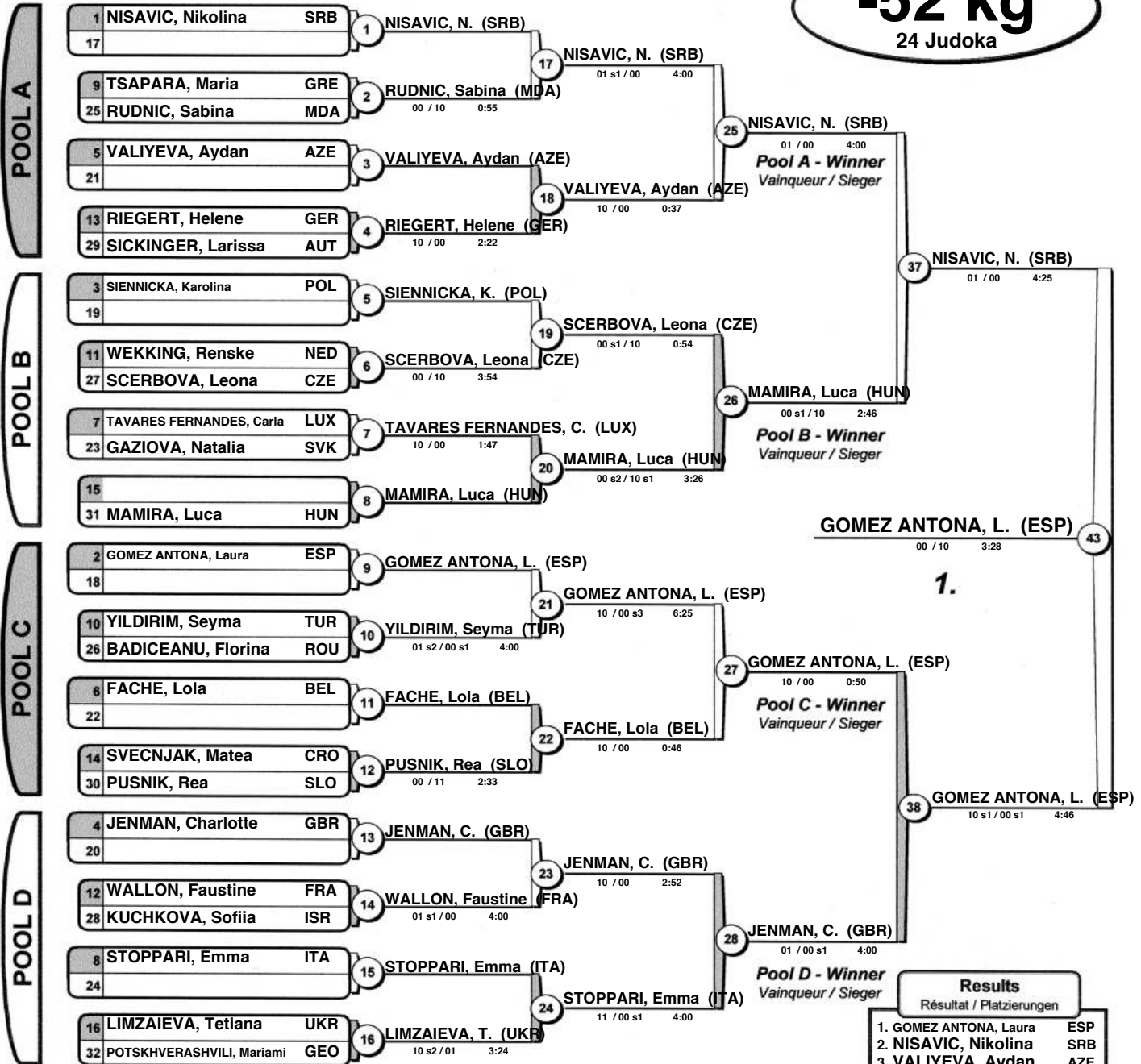

Results		
Résultat / Platzierungen		
1.	GOMEZ ANTONA, Laura	ESP
2.	NISAVIC, Nikolina	SRB
3.	VALIYEVA, Aydan	AZE
4.	MAMIRA, Luca	HUN
5.	JENMAN, Charlotte	GBR
6.	WALLON, Faustine	FRA
7.	SCERBOVA, Leona	CZE
8.	YILDIRIM, Seyma	TUR

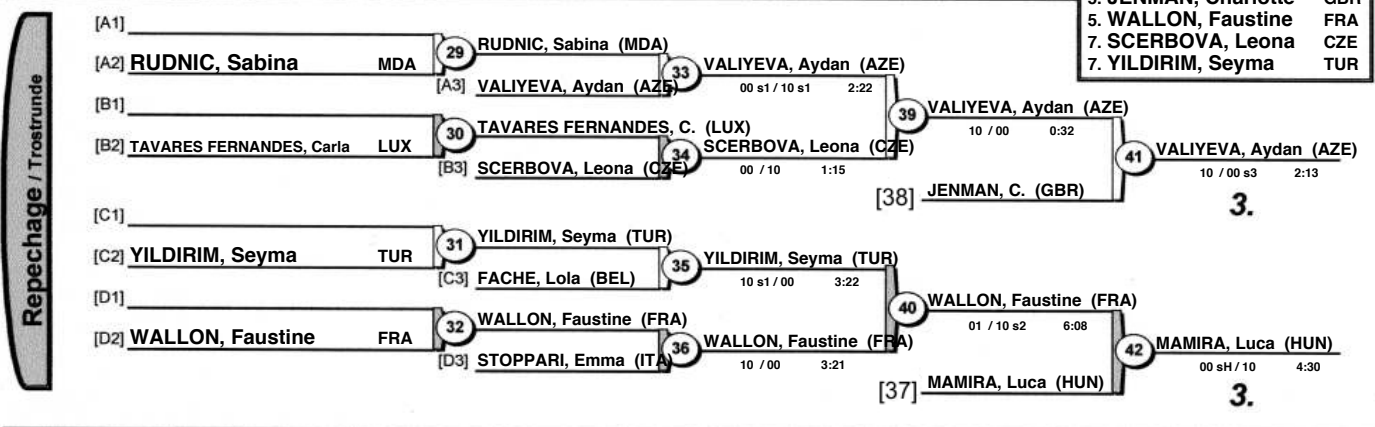

-57 kg
21 Judoka

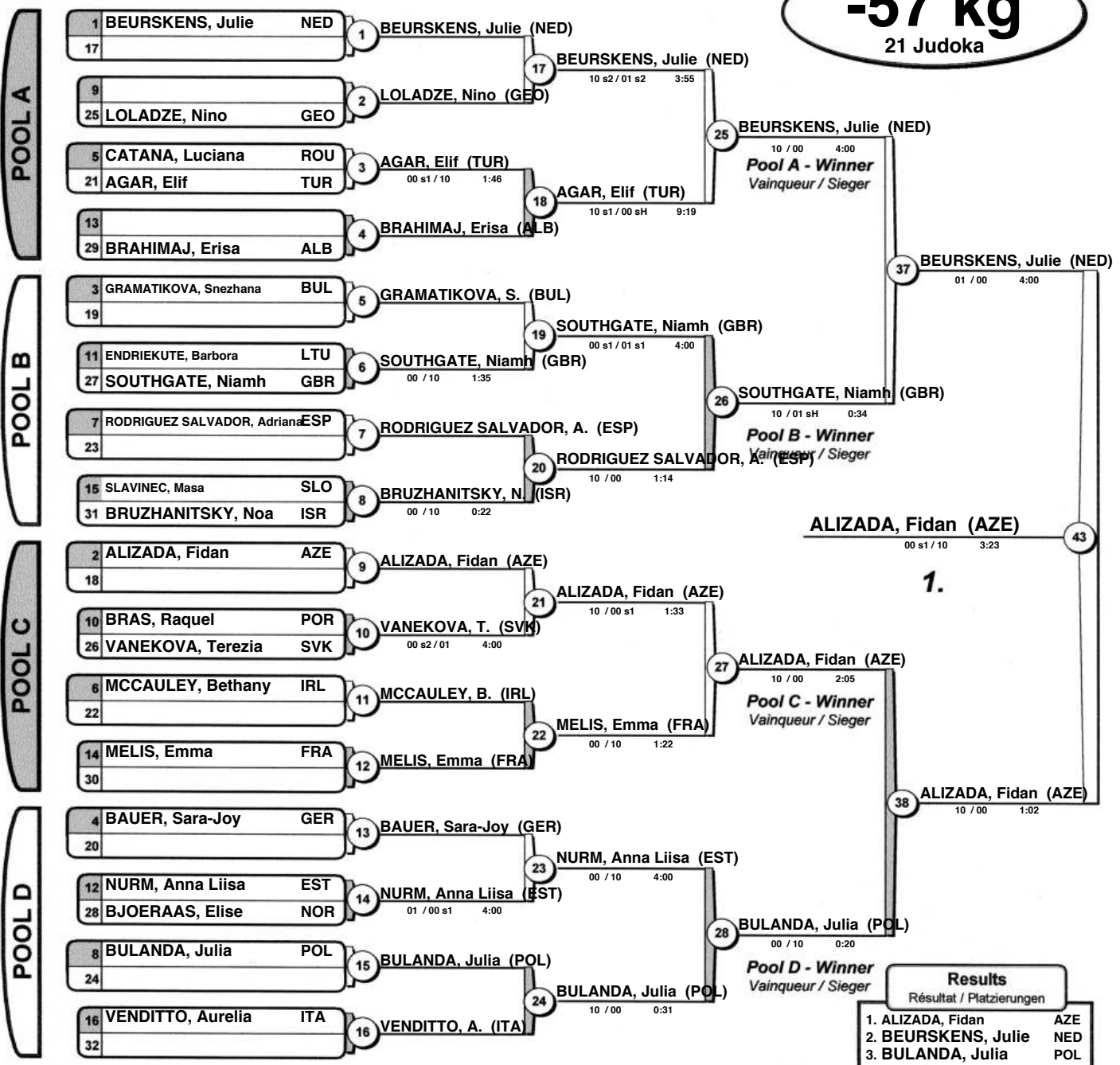

Results	
Resultat / Platzierungen	
1.	ALIZADA, Fidan AZE
2.	BEURSKENS, Julie NED
3.	BULANDA, Julia POL
4.	MELIS, Emma FRA
5.	RODRIGUEZ SALVADOR, A. (ESP)
6.	SOUTHGATE, Niamh GBR
7.	LOLADZE, Nino GEO
8.	NURM, Anna Liisa EST

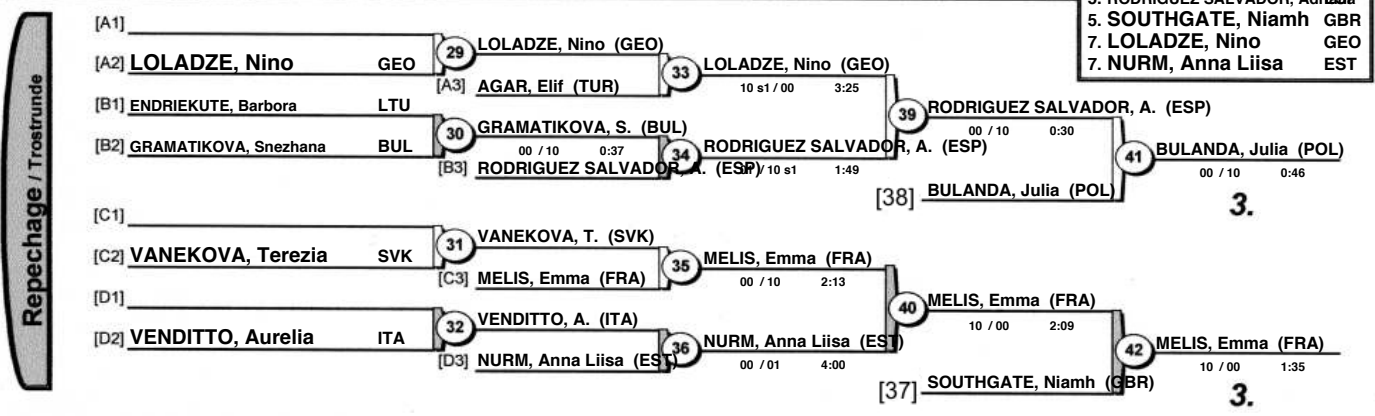

-63 kg
23 Judoka

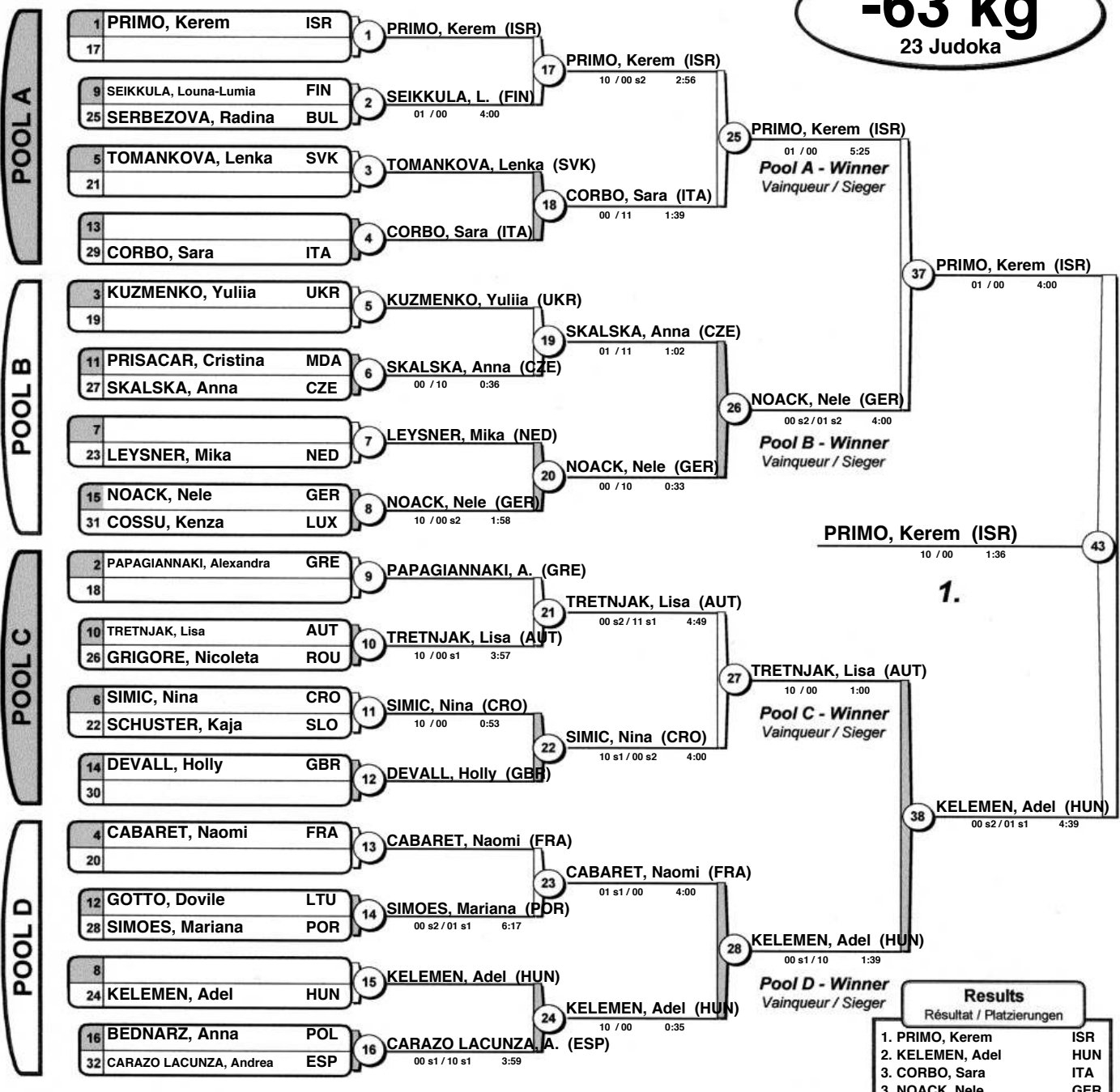

Results		
Résultat / Platzierungen		
1.	PRIMO, Kerem	ISR
2.	KELEMEN, Adel	HUN
3.	CORBO, Sara	ITA
3.	NOACK, Nele	GER
5.	TRETNJAK, Lisa	AUT
5.	CABARET, Naomi	FRA
7.	LEYSNER, Mika	NED
7.	SIMIC, Nina	CRO

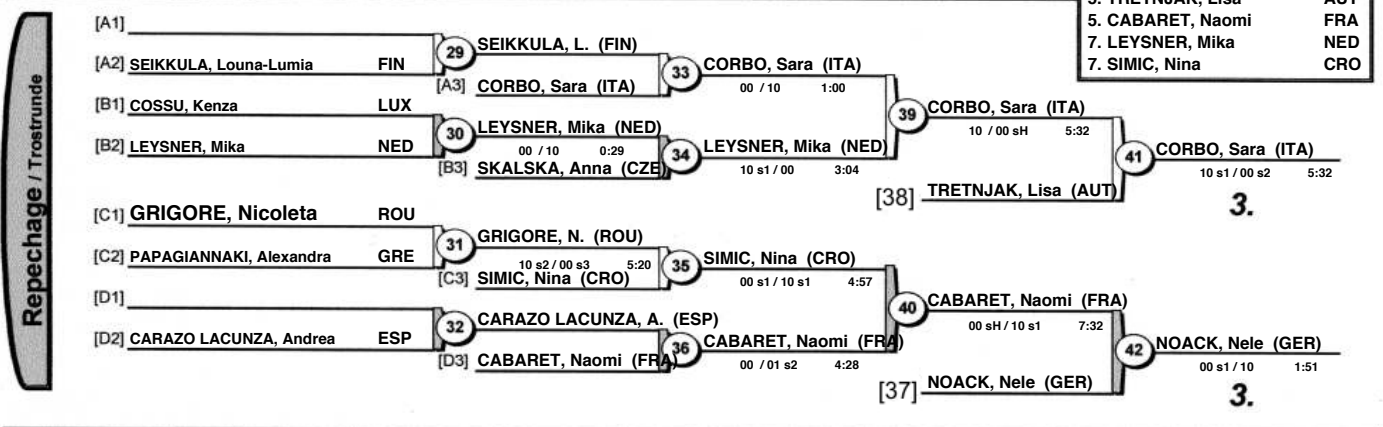

-70 kg
21 Judoka

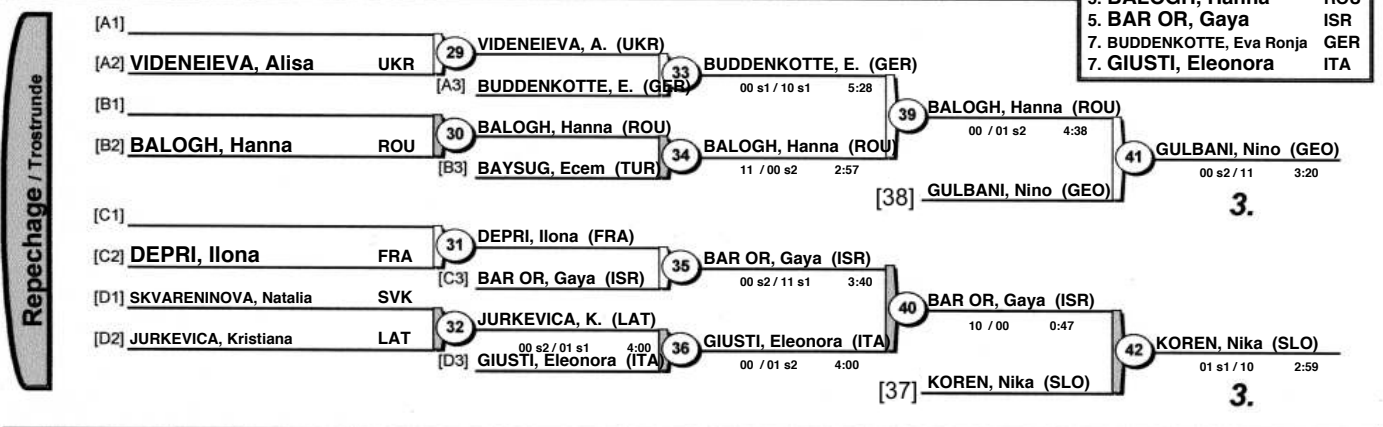
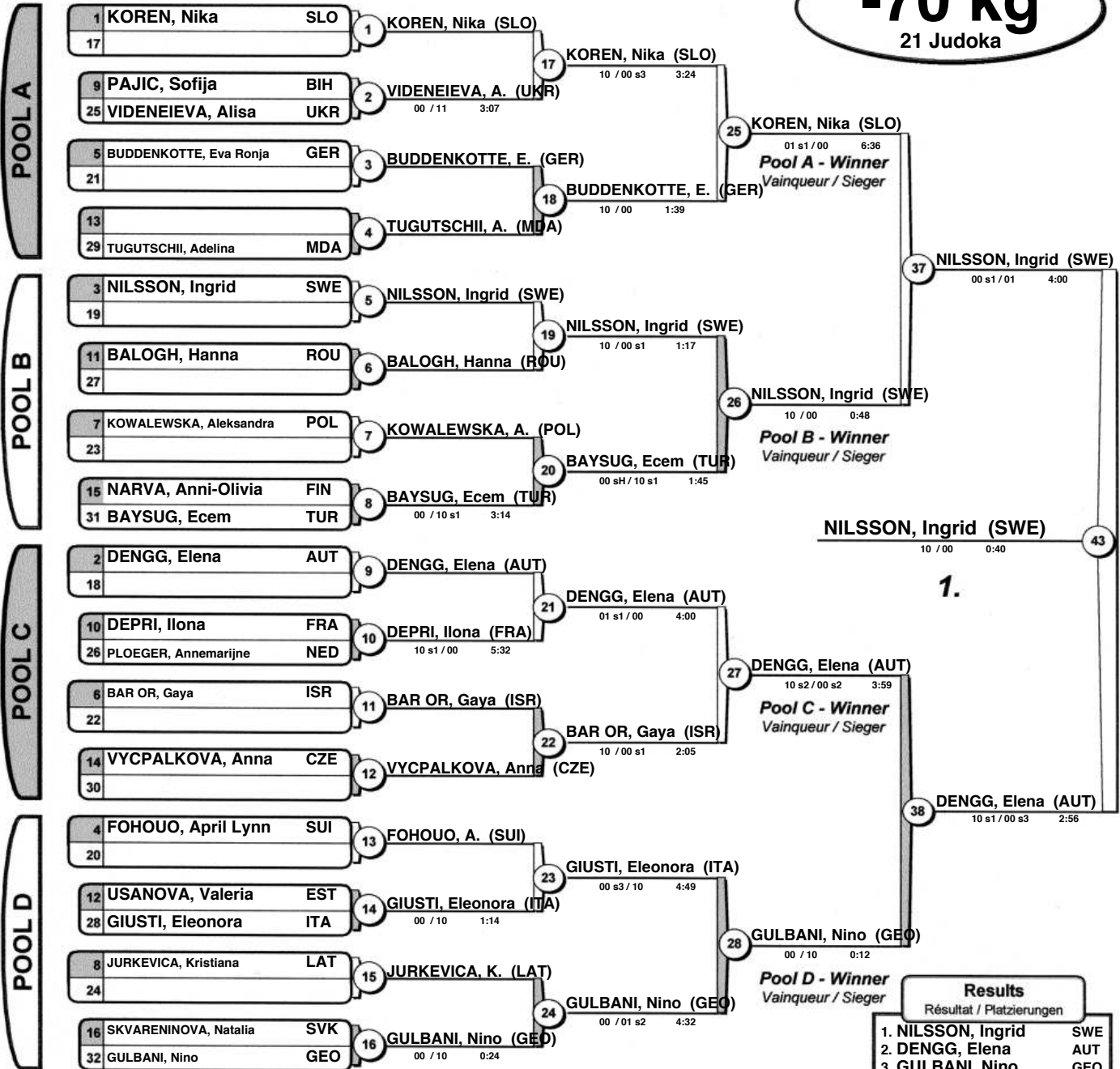

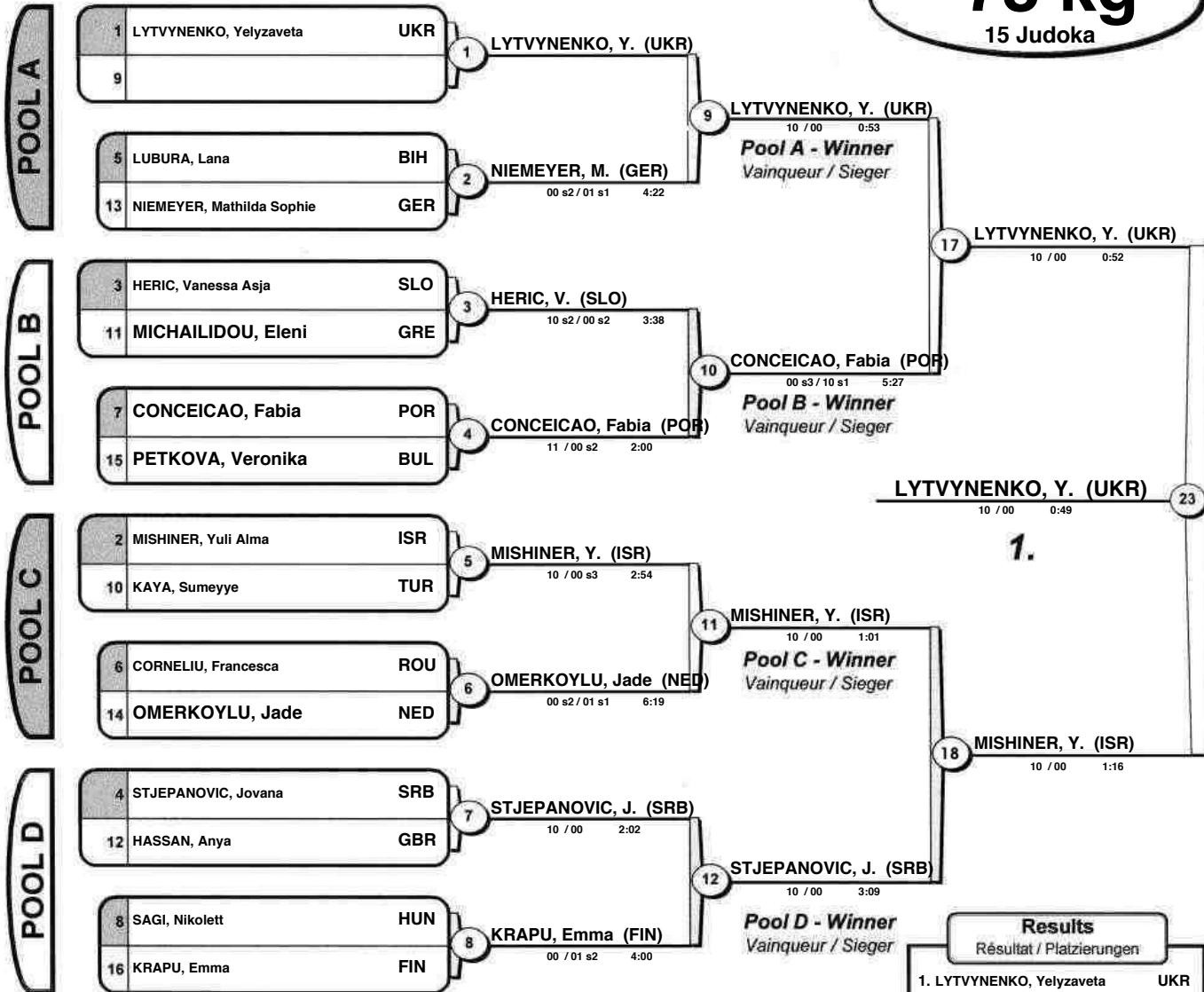

Results		
Résultat / Platzierungen		
1.	LYTVYENKO, Yelyzaveta	UKR
2.	MISHINER, Yuli Alma	ISR
3.	NIEMEYER, Mathilda Sophie	GER
4.	CONCEICAO, Fabia	POR
5.	STJEPANOVIC, Jovana	SRB
6.	KAYA, Sumeyye	TUR
7.	HERIC, Vanessa Asja	SLO
7.	KRAPU, Emma	FIN

			1	3	5	Wins Score	
1	DE PAOLI, Morgana	ITA		0	1	1 0	
3	LANG, Bintibe	FRA	1		1	2 0	
5	SULEYMANOVA, Nigar	AZE	0	0		0 0	

			2	4	Wins	Scores
2	SEMCHENKO, Diana	UKR		1		(0)
4	VRANJES, Marcelina	CRO	0			(0)

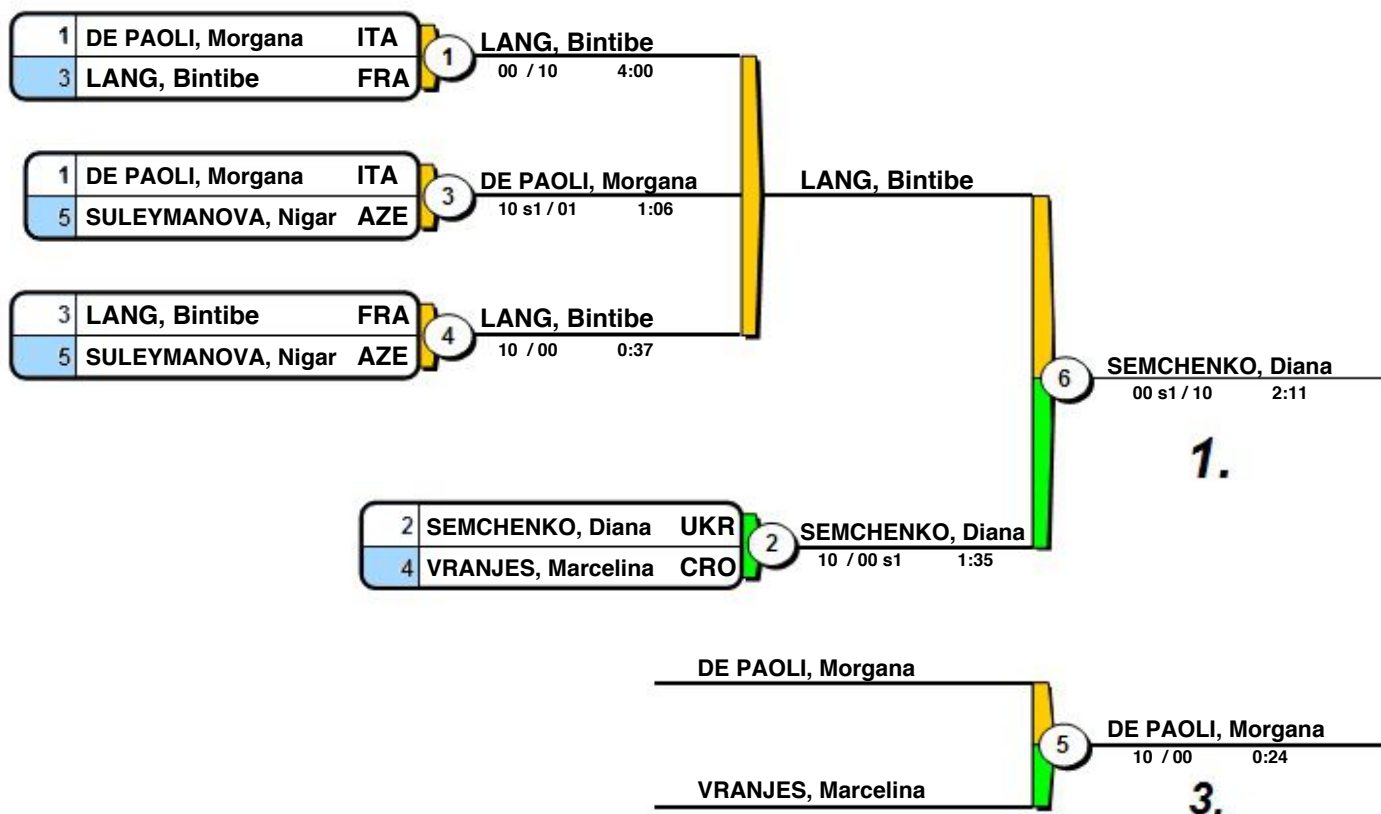

Final Results

- SEMCHENKO, Diana UKR
- LANG, Bintibe FRA
- DE PAOLI, Morgana ITA