

Junior European Judo Cup - Udine 2021

Udine (ITA), 11-12 Aug 2021

-60 kg

37 Judoka

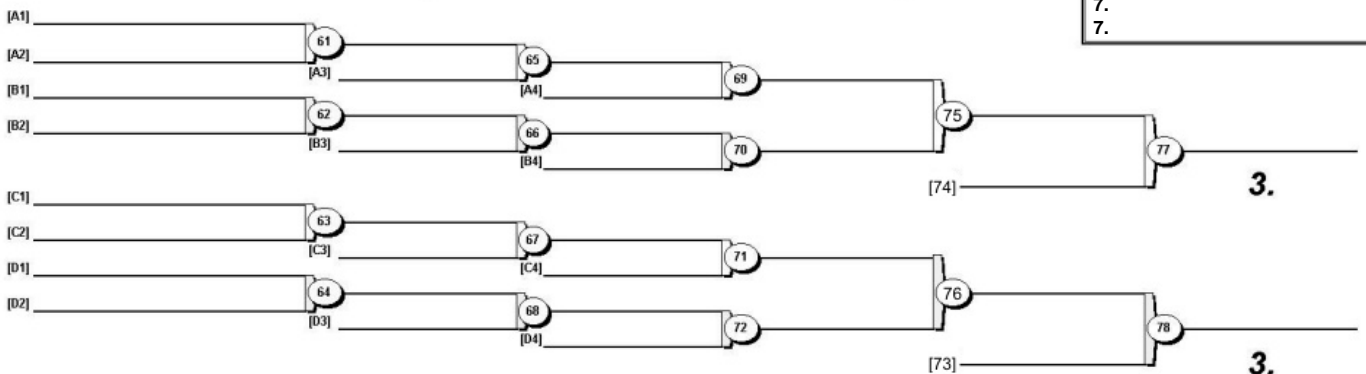
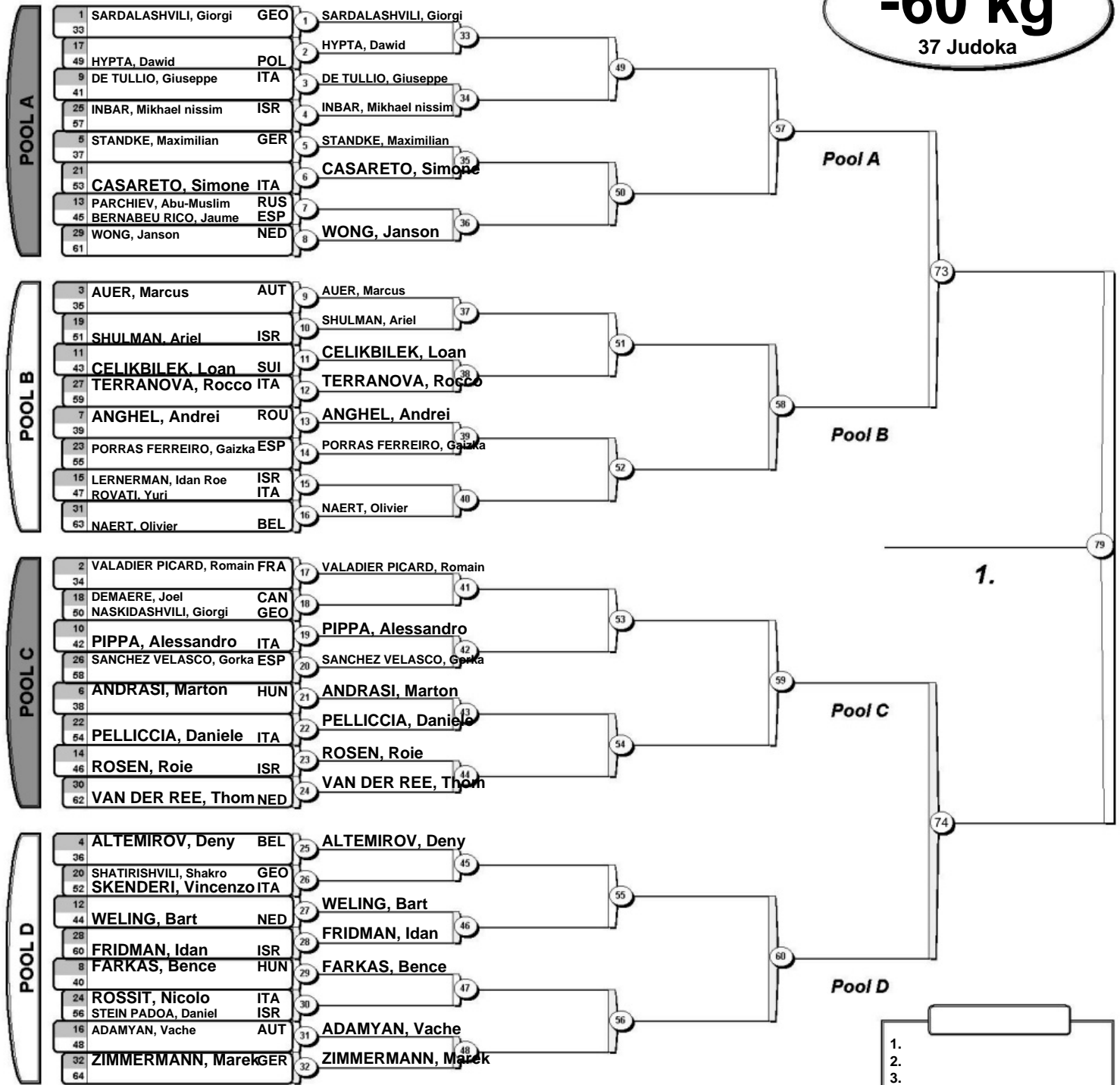

Junior European Judo Cup - Udine 2021

Udine (ITA), 11-12 Aug 2021

-73 kg

44 Judoka

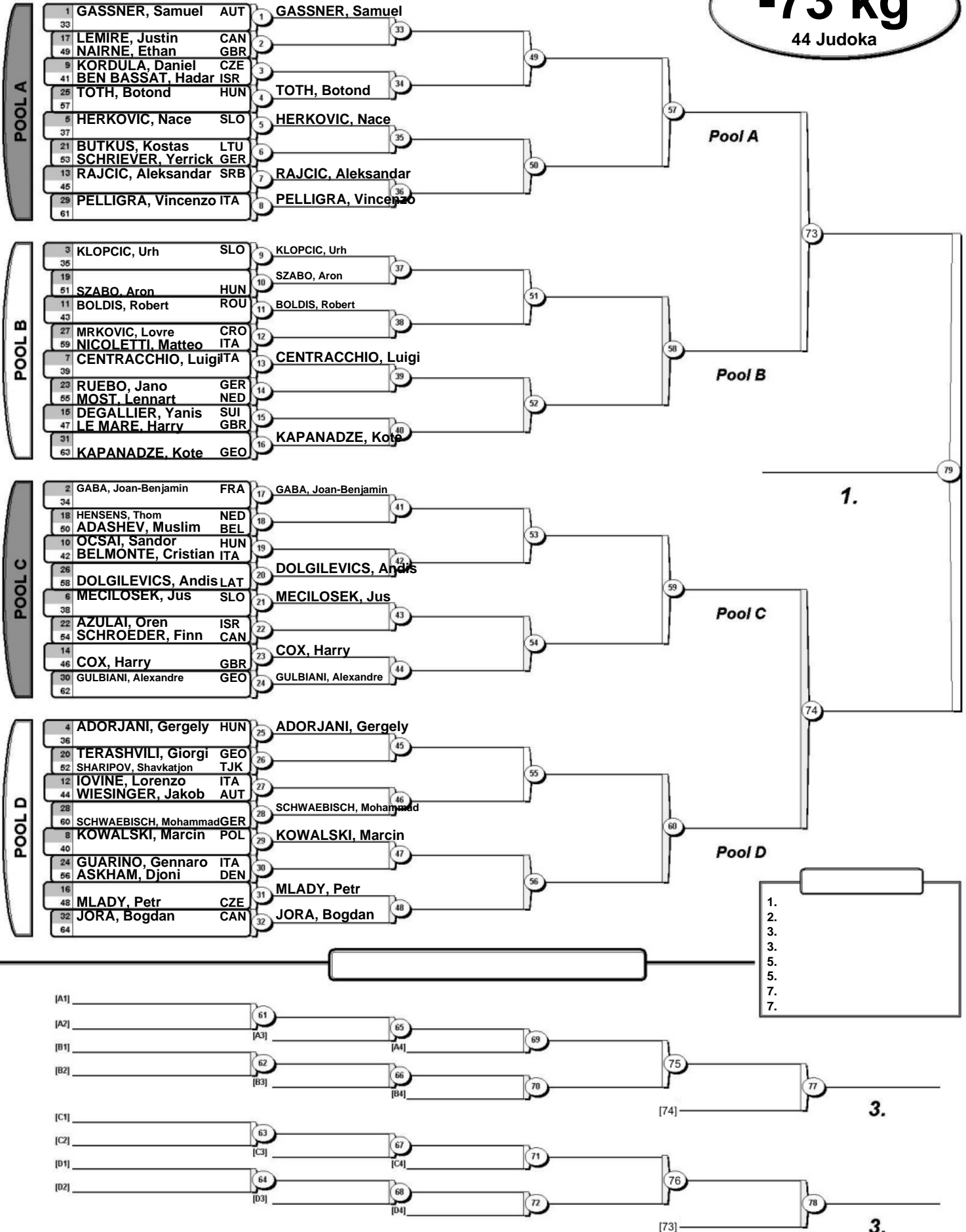

Junior European Judo Cup - Udine 2021

Udine (ITA), 11-12 Aug 2021

-81 kg

37 Judoka

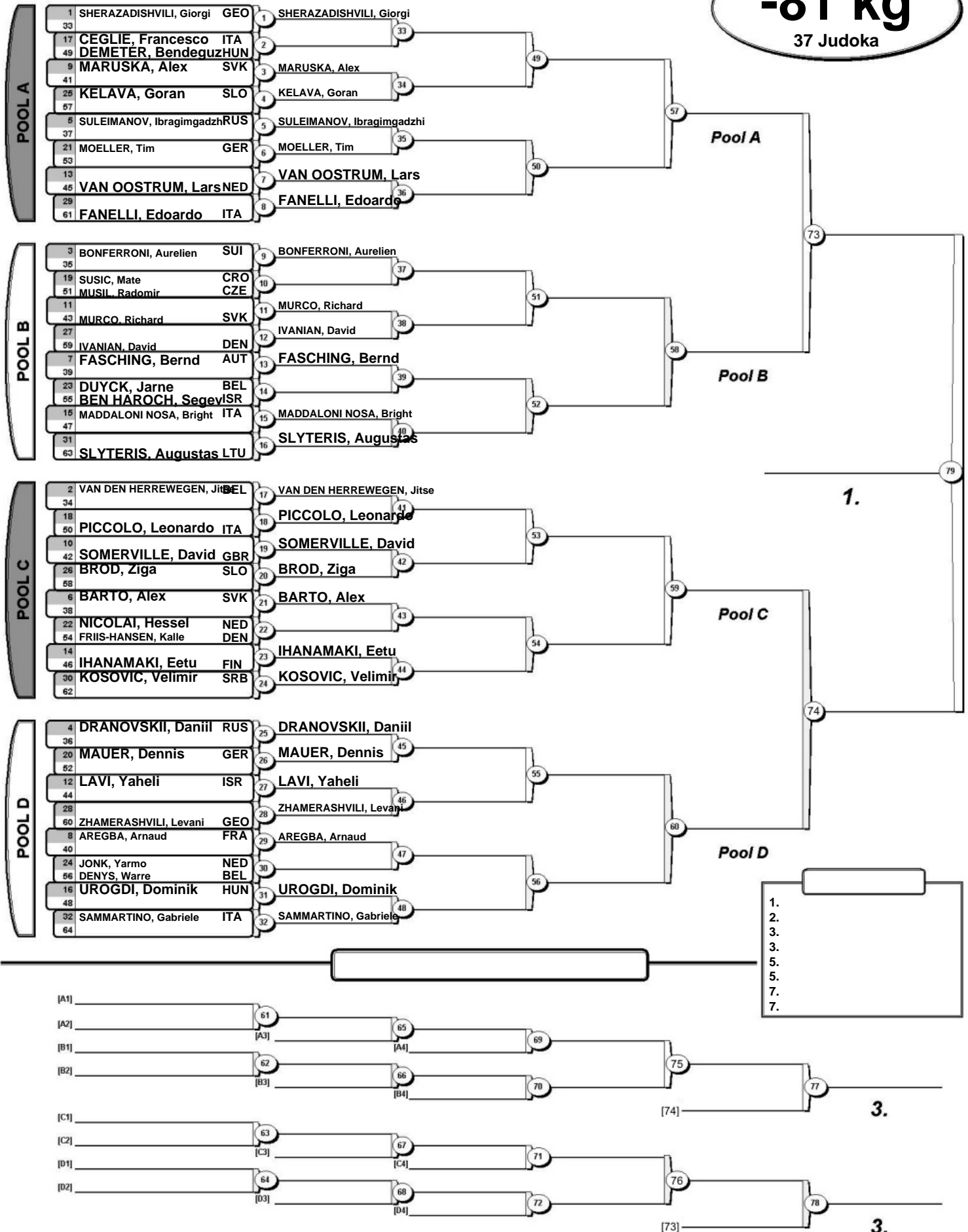

Junior European Judo Cup - Udine 2021

Udine (ITA), 11-12 Aug 2021

-90 kg

20 Judoka

POOL A

1	NERPEL, Gergely	HUN	1	NERPEL, Gergely (HUN)
17			17	
9	RIJKSEN SALMAN, Ryan	GBR	2	
25	YOUNG, Keagan	CAN	2	
5	SIVAN, Roy	ISR	3	SIVAN, Roy (ISR)
21			18	
13	MATASEJE, Benjamin	SVK	4	MATASEJE, B. (SVK)
29				

Pool A - Winner
Vainqueur / Sieger

POOL B

3	KHARAZISHVILI, Nika	GEO	5	KHARAZISHVILI, N. (GEO)
19			19	
11	KANSY, Fabian	GER	6	
27	KEVLISHVILI, Nika	ESP	6	
7	MGEBRISHVILI, Lasha	GEO	7	MGEBRISHVILI, L. (GEO)
23			20	
15	HOELLWART, Moritz	AUT	8	HOELLWART, M. (AUT)
31				

Pool B - Winner
Vainqueur / Sieger

POOL C

2	SAFRANY, Peter	HUN	9	SAFRANY, Peter (HUN)
18			21	
10	DEWULF, Jarno	BEL	10	
26	BERTALANIC ZIZEK, Gal	SLO	10	
6	POLADISHVILI, Tornike	GEO	11	POLADISHVILI, T. (GEO)
22			22	
14			12	KROLL, Elias (GER)
30	KROLL, Elias	GER	12	

Pool C - Winner
Vainqueur / Sieger

POOL D

4	SANGARIEV, Adam	RUS	13	SANGARIEV, Adam (RUS)
20			23	
12			14	ARENCIBIA, A. (CAN)
28	ARENCIBIA, Alexandre	CAN	14	
8	BAATHE, Karl	SWE	15	BAATHE, Karl (SWE)
24			24	
16	RET, Samuel	SVK	16	
32	ARAMBARRI PENA, Gorka	ESP	16	

Pool D - Winner
Vainqueur / Sieger

1.

Results
Résultat / Platzierungen

- 1.
- 2.
- 3.
- 3.
- 5.
- 7.
- 7.

Repechage / Trostrunde

[A1]		29		33			
[A2]			[A3]				
[B1]					39		
[B2]		30		34		41	
			[B3]				
[C1]					[38]		3.
[C2]		31		35			
			[C3]				
[D1]					40		
[D2]		32		36		42	
			[D3]				
					[37]		3.

Junior European Judo Cup - Udine 2021

Udine (ITA), 11-12 Aug 2021

-100 kg

16 Judoka

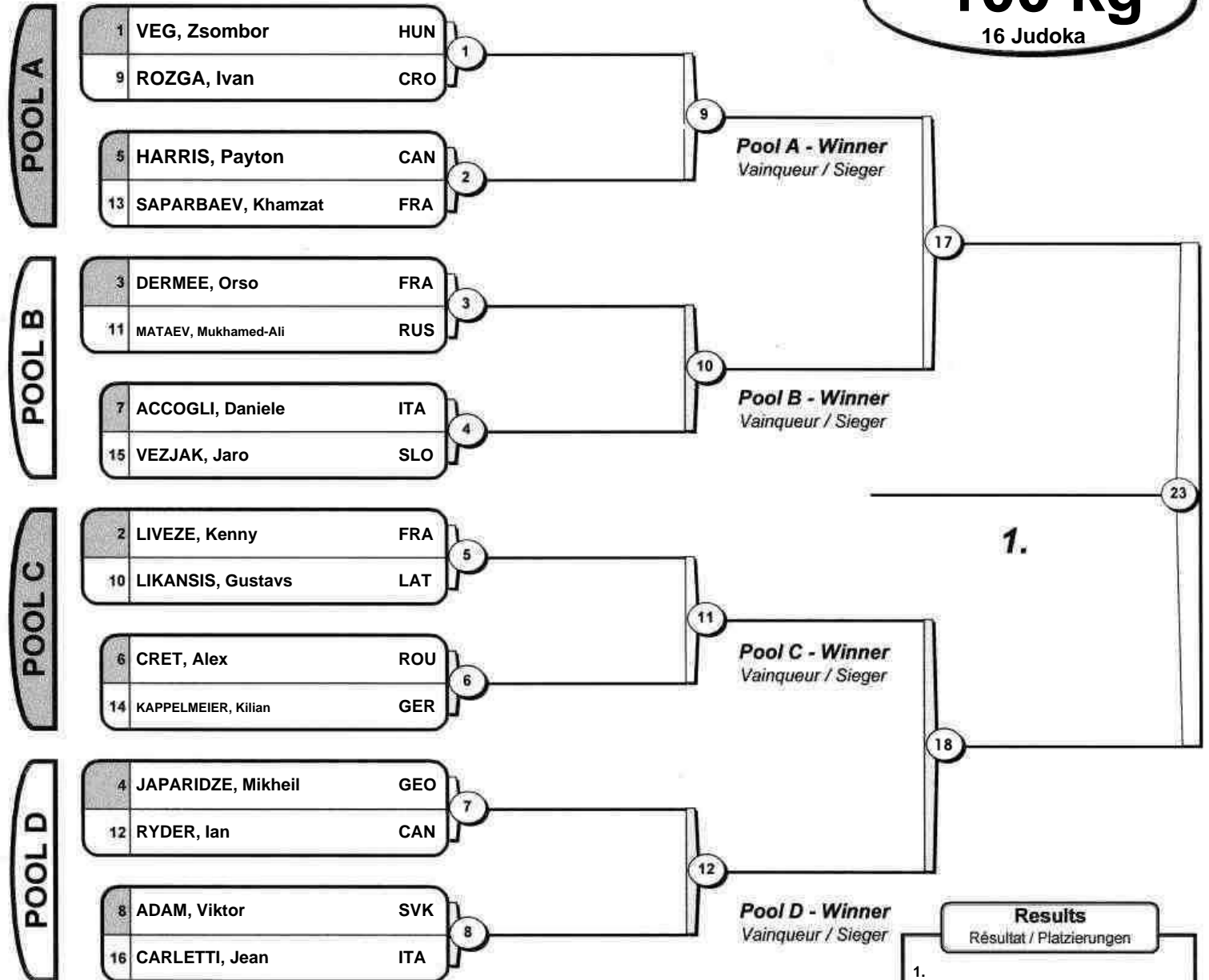

Results	
Résultat / Platzierungen	
1.	
2.	
3.	
3.	
5.	
7.	
7.	

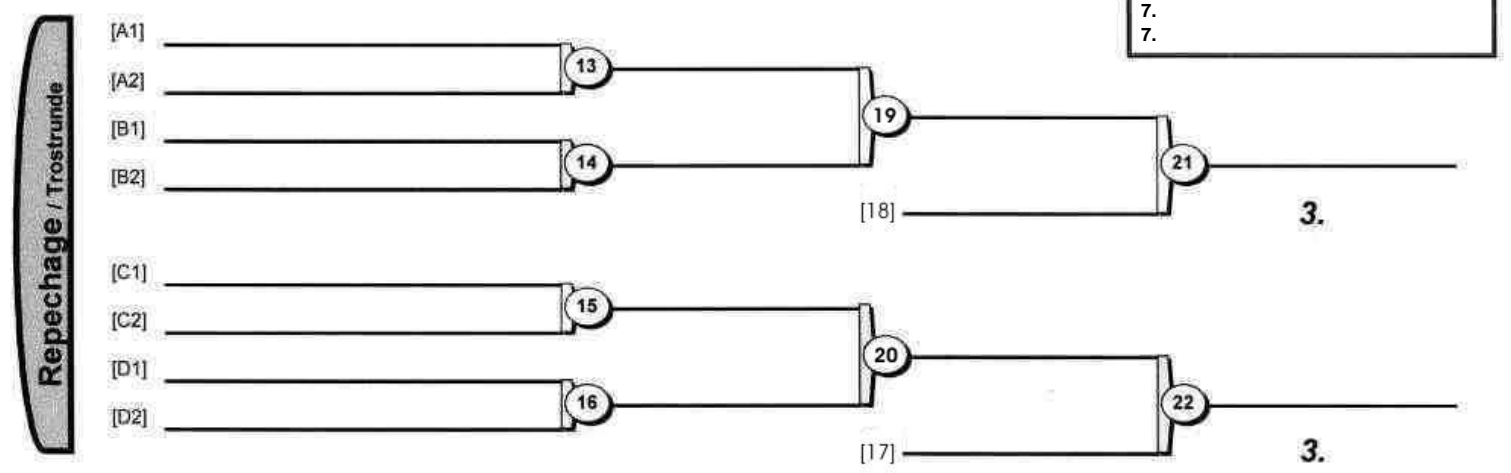

Junior European Judo Cup - Udine 2021

Udine (ITA), 11-12 Aug 2021

+100 kg

17 Judoka

POOL A

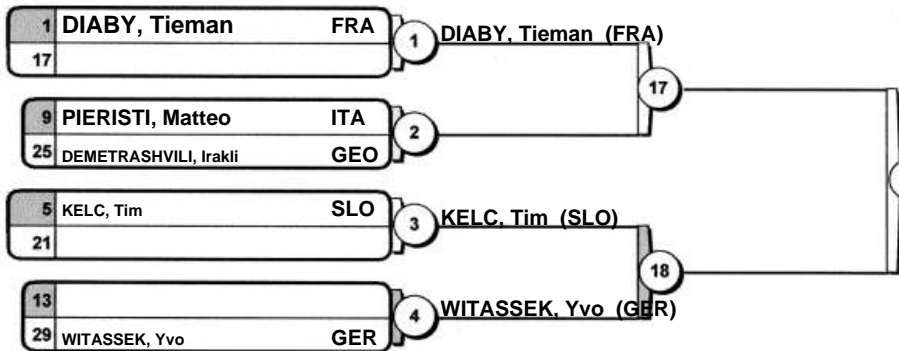

Pool A - Winner
Vainqueur / Sieger

POOL B

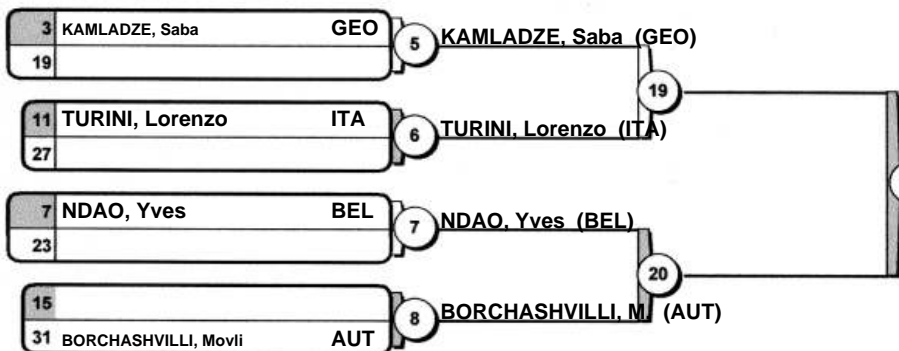

Pool B - Winner
Vainqueur / Sieger

POOL C



Pool C - Winner
Vainqueur / Sieger

POOL D

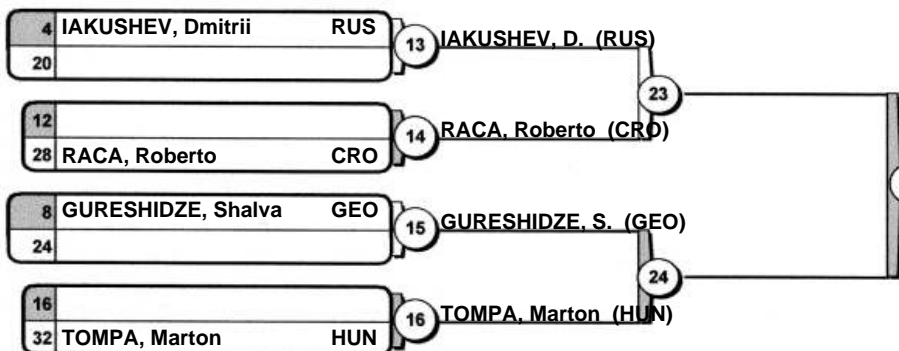

Pool D - Winner
Vainqueur / Sieger

1.

Results
Résultat / Platzierungen

- 1.
- 2.
- 3.
- 5.
- 7.
- 7.

Repechage / Trostrunde

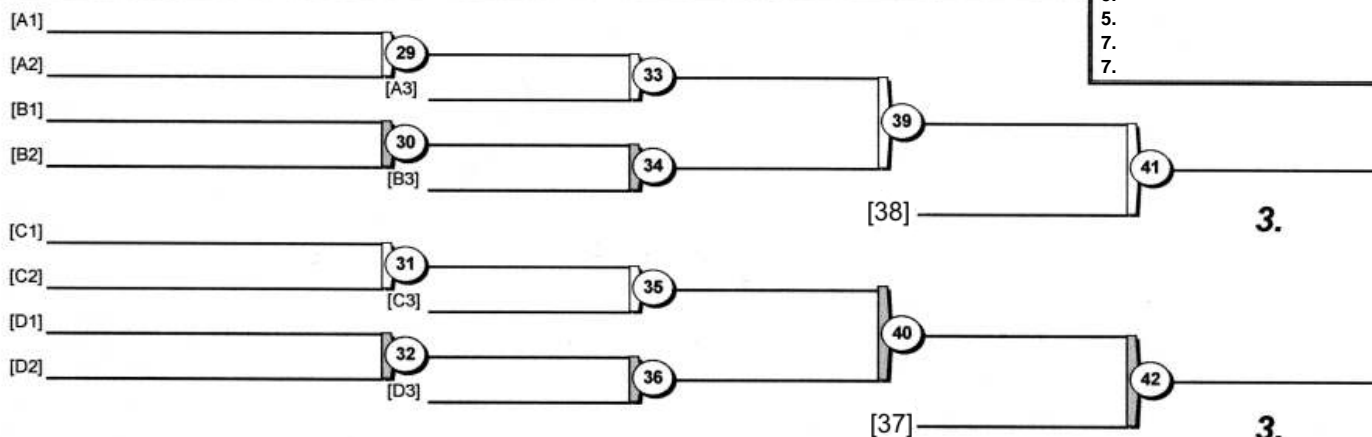

3.

3.

Junior European Judo Cup - Udine 2021

Udine (ITA), 11-12 Aug 2021

-48 kg

14 Judoka

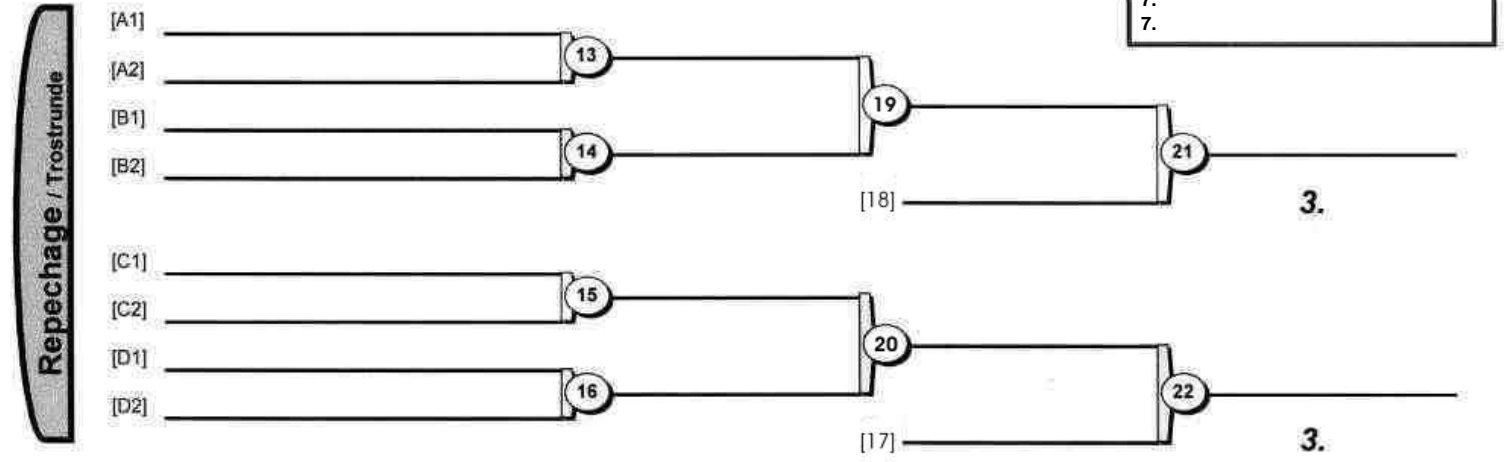
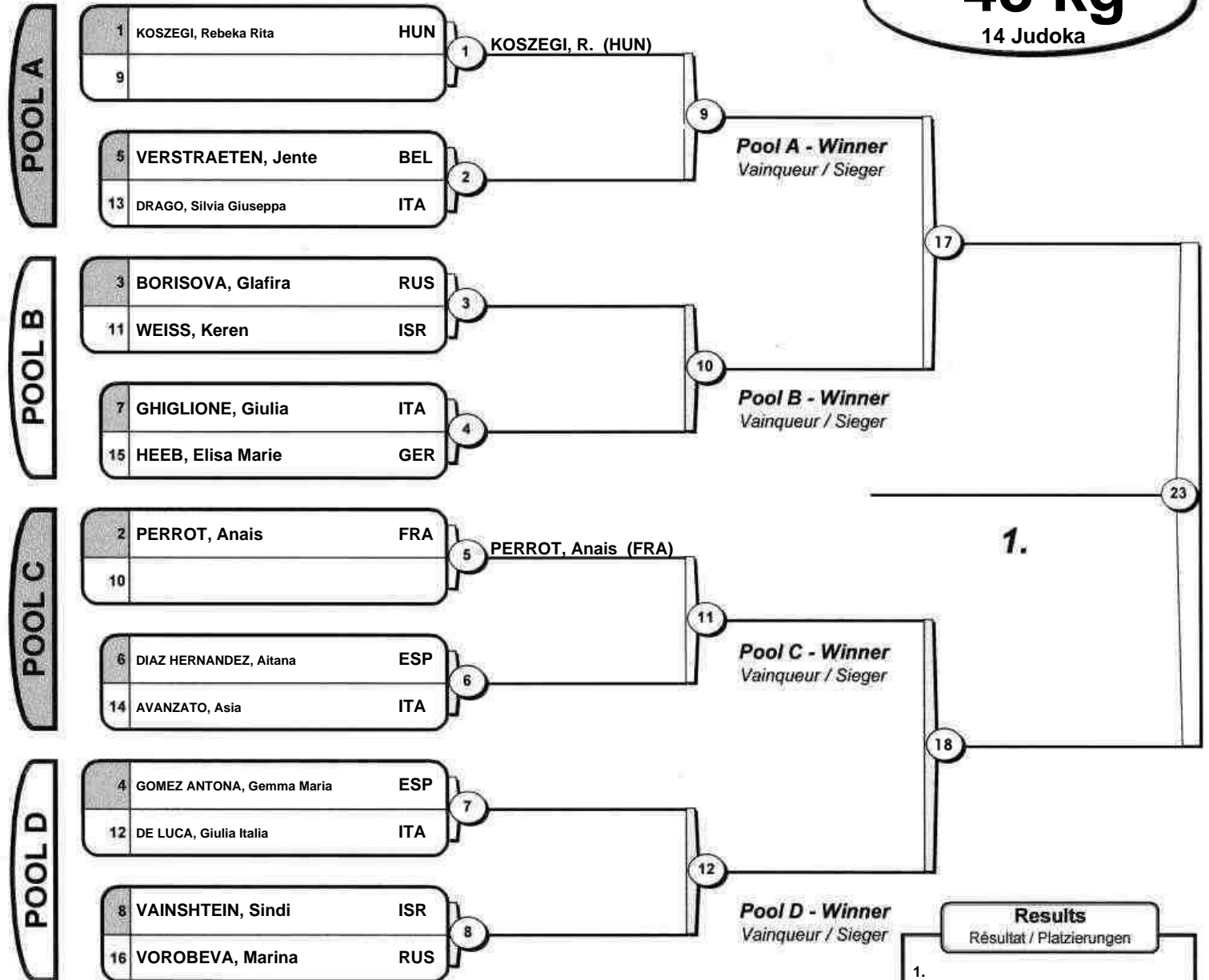

Junior European Judo Cup - Udine 2021

Udine (ITA), 11-12 Aug 2021

-52 kg

19 Judoka

POOL A

1	NUGAEVA, Liliia	RUS	1	NUGAEVA, Liliia (RUS)
17			17	
9	CANNARA, Giorgia	ITA	2	CANNARA, Giorgia (ITA)
25			25	
5	KELLER, Rebeka	HUN	3	KELLER, Rebeka (HUN)
21			18	
13	RAAB, Yarden	ISR	4	RAAB, Yarden (ISR)
29				

Pool A - Winner
Vainqueur / Sieger

POOL B

3	TORO SOLER, Ariane	ESP	5	TORO SOLER, A. (ESP)
19			19	
11	HILLER, Laura	GER	6	HILLER, Laura (GER)
27			26	
7	CASTELLO DIEZ, Marina	ESP	7	CASTELLO DIEZ, M. (ESP)
23			20	
15	LEONE, Miriam	ITA	8	
31	BOBROWSKA, Sian	GBR		

Pool B - Winner
Vainqueur / Sieger

POOL C

2	MONACO, Ylenia	ITA	9	MONACO, Ylenia (ITA)
18			21	
10			10	KAFRI, Paz (ISR)
26	KAFRI, Paz	ISR		
6	GYERTYAS, Roza	HUN	11	GYERTYAS, Roza (HUN)
22			22	
14	MUMINOVIQ, Erza	KOS	12	
30	STAKHOV, Nicole	GER		

Pool C - Winner
Vainqueur / Sieger

POOL D

4	SILVERI, Federica	ITA	13	SILVERI, F. (ITA)
20			23	
12	GRENIER, Amelie	CAN	14	
28	KEEN, Tatum	GBR		
8	AMANN, Fanny	AUT	15	AMANN, Fanny (AUT)
24			24	
16			16	INSUA IGLESIAS, A. (ESP)
32	INSUA IGLESIAS, Andrea	ESP		

Pool D - Winner
Vainqueur / Sieger

1.

Results
Résultat / Platzierungen

- 1.
- 2.
- 3.
- 3.
- 5.
- 7.
- 7.

Repechage / Trostrunde

[A1]		29		33			
[A2]			[A3]				
[B1]					39		
[B2]		30		34		41	
			[B3]				
[C1]					[38]		3.
[C2]		31		35			
			[C3]				
[D1]					40		
[D2]		32		36		42	
			[D3]				
					[37]		3.

Junior European Judo Cup - Udine 2021

Udine (ITA), 11-12 Aug 2021

-57 kg

27 Judoka

POOL A

1	GERTSCH, Olivia	SUI	1	GERTSCH, Olivia (SUI)
17				
9	RASPE, Vera	NED	2	
25	KASAPI, Fationa	KOS		
5	SKRABL, Ana	SLO	3	
21	SLAMBERGER, Yara	GER		
13	LIENGME, Marion	ESP	4	
29	DORI, Romi	ISR		

Pool A - Winner
Vainqueur / Sieger

POOL B

3	BAUER, Bettina	GER	5	BAUER, Bettina (GER)
19				
11	MILAZZO, MARIA CONCETTA	ITA	6	
27	KRIZA, Anna	HUN		
7	MARTIN GIL, Alicia	ESP	7	MARTIN GIL, A. (ESP)
23				
15	VACLAVKOVA, Tereza	CZE	8	
31	VAUHKONEN, Erika	FIN		

Pool B - Winner
Vainqueur / Sieger

POOL C

2	GRABNER, Lisa	AUT	9	GRABNER, Lisa (AUT)
18				
10	ELKINA, Natalia	RUS	10	
26	SAKHATSKA, Sofiya	ISR		
6	SOKIRJANSKA, Anastasija	LAT	11	
22	LO-A-NJOE, Dewy	NED		
14	PUECHEL, Sophie	GER	12	
30	PEREZ PACHECO, Veronica	ESP		

Pool C - Winner
Vainqueur / Sieger

POOL D

4	AVANZATO, Carlotta	ITA	13	AVANZATO, C. (ITA)
20				
12	HENNINGER, Elin	NED	14	
28	MUENCH, Jadzia	GER		
8	TELEM, YAEL	ISR	15	
24	GOEBEL, Laila	GER		
16	ALEXANDER, Eibhleann	CAN	16	
32	ROSSET, Aline	SUI		

Pool D - Winner
Vainqueur / Sieger

1.

Results
Résultat / Platzierungen

- 1.
- 2.
- 3.
- 3.
- 5.
- 5.
- 7.
- 7.

Repechage / Trostrunde

[A1]					
[A2]		29		33	
[B1]			[A3]		
[B2]		30		34	
			[B3]		
[C1]					[38]
[C2]		31		35	
[D1]			[C3]		
[D2]		32		36	
			[D3]		
					[37]

3.

3.

Junior European Judo Cup - Udine 2021

Udine (ITA), 11-12 Aug 2021

-63 kg

23 Judoka

POOL A

1 VAZQUEZ FERNANDEZ, Laura ESP 1 VAZQUEZ FERNANDEZ, L. (ESP)
17

9 VIT, Lili HUN 2
25 KOGAN, Maya ISR

5 HARRIS, Isabelle CAN 3 HARRIS, Isabelle (CAN)
21

13 KROON, Esmee NED 4
29 FISCHER, Malin GER

Pool A - Winner
Vainqueur / Sieger

POOL B

3 CAPANNI DIAS, Thauany David ITA 5 CAPANNI DIAS, T. (ITA)
19

11 FORTNER, Jessica AUT 6
27 NOVITZKI, Adelina ISR

7 PALUMBO, Antonietta ITA 7 PALUMBO, A. (ITA)
23

15 DURAND, Maevane FRA 8
31 GALITSKAIA, Kseniia RUS

Pool B - Winner
Vainqueur / Sieger

POOL C

2 KRISTO, Katarina CRO 9 KRISTO, Katarina (CRO)
18

10 KALLINGER, Laura AUT 10
26 ZOHAR, Yemima ISR

6 VASILIAUSKAITE, Aida LTU 11 VASILIAUSKAITE, A. (LTU)
22

14 SIMARD, Justine CAN 12
30 PETER, Fruzsina HUN

Pool C - Winner
Vainqueur / Sieger

POOL D

4 VARGA, Brigitta HUN 13 VARGA, Brigitta (HUN)
20

12 ZUCCO, Agnese ITA 14
28 COHEN UDI, Yuval ISR

8 FOLGER, Viktoria GER 15 FOLGER, Viktoria (GER)
24

16 MIEKKALEHTO, Ronja FIN 16 MIEKKALEHTO, R. (FIN)
32

Pool D - Winner
Vainqueur / Sieger

1.

Results
Résultat / Platzierungen

- 1.
- 2.
- 3.
- 3.
- 5.
- 7.
- 7.

Repechage / Trostrunde

[A1] 29 [A2] 33 [A3]

[B1] 30 [B2] 34 [B3]

[C1] 31 [C2] 35 [C3]

[D1] 32 [D2] 36 [D3]

[38]

[37]

3.

3.

Junior European Judo Cup - Udine 2021

Udine (ITA), 11-12 Aug 2021

-70 kg

30 Judoka

POOL A

1	ESPOSITO, Martina	ITA	1	ESPOSITO, M. (ITA)
17				

9	KOLAR, Stasa	SLO	2	
25	PILECKAITE, Ugne	LTU		

5	STOLZE, Friederike	GER	3	
21	INSUA IGLESIAS, Noelia	ESP		

13	ZARYBNICKA, Julie	CZE	4	
29	KULIC, Karla	CRO		

POOL B

3	ISSOUFI, Kaila	FRA	5	
19	LEFORT, Alexandria	CAN		

11	KRAFT, Pia-Jacqueline	AUT	6	
27	BEOLCHI, Alessia	ITA		

7	NILSSON, Matilda	SWE	7	
23	VASILEVA, Daria	RUS		

15	CIANO, Raffaella Lelia	ITA	8	
31	MURPHY, Bertille	GER		

POOL C

2	TSUNODA ROUSTANT, Ai	ESP	9	TSUNODA ROUSTANT, A. (ESP)
18				

10	NOTTI, Matilde	ITA	10	
26	MEHLAU, Sarah	GER		

6	SCHUCHTER, Anna-Lena	AUT	11	
22	FRANZOSI, Ludovica	ITA		

14	SOULA, Florine	FRA	12	
30	LAURITSEN, Isabella	DEN		

POOL D

4	CZERLAU, Jennifer	HUN	13	
20	BETEMPS, Cecilia	ITA		

12	SUMMER, Laura	AUT	14	
28	RINAKOVA, Sarlota	SVK		

8	VETTERLI, Delia Moira	SUI	15	
24	VAN WONDEREN, Dagmar	NED		

16	BOCK, Samira	GER	16	
32	AMENDOLA, Vincenza	ITA		

Pool A - Winner
Vainqueur / Sieger

Pool B - Winner
Vainqueur / Sieger

Pool C - Winner
Vainqueur / Sieger

Pool D - Winner
Vainqueur / Sieger

1.

Results
Résultat / Platzierungen

- 1.
- 2.
- 3.
- 3.
- 5.
- 7.
- 7.

Repechage / Trostrunde

[A1]		29		33
[A2]			[A3]	

[B1]		30		34
[B2]			[B3]	

[C1]		31		35
[C2]			[C3]	

[D1]		32		36
[D2]			[D3]	

[38]

[37]

3.

3.

Junior European Judo Cup - Udine 2021

Udine (ITA), 11-12 Aug 2021

-78 kg

10 Judoka

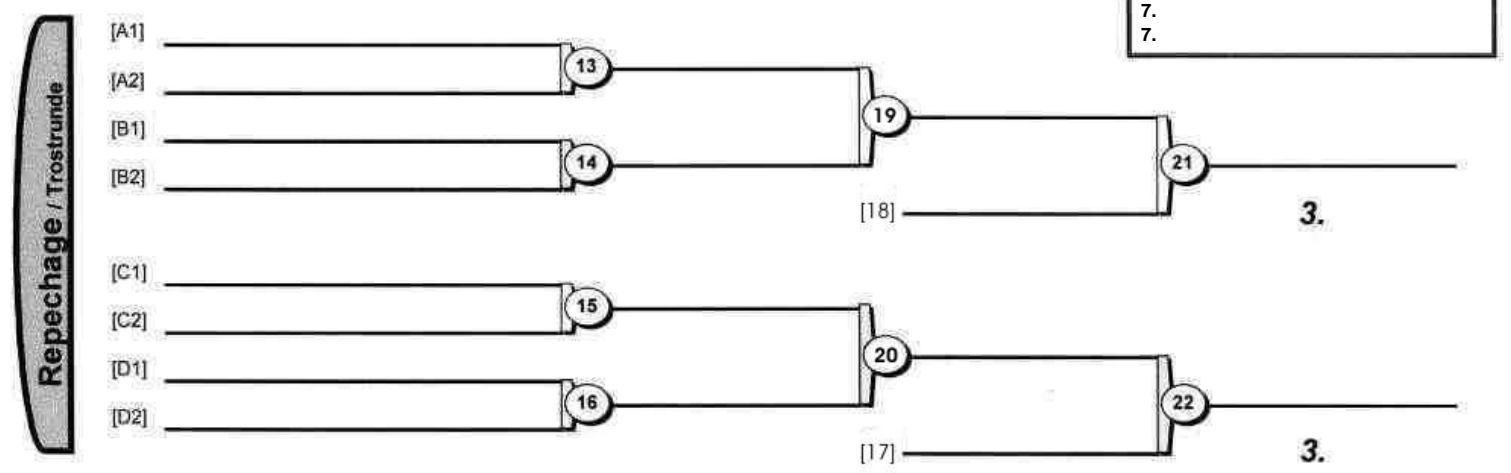
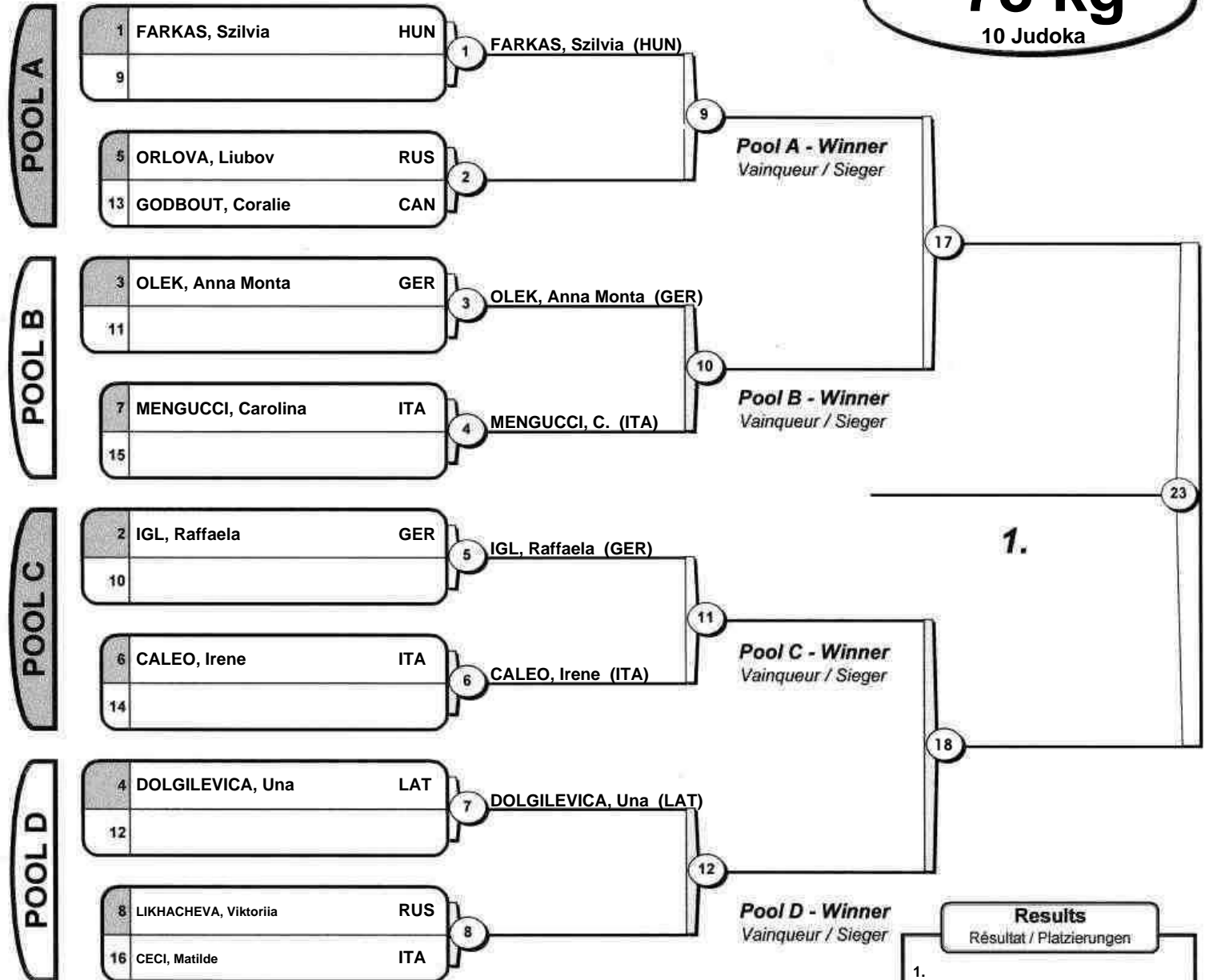

Junior European Judo Cup - Udine 2021

Udine (ITA), 11-12 Aug 2021

+78 kg

6 Judoka

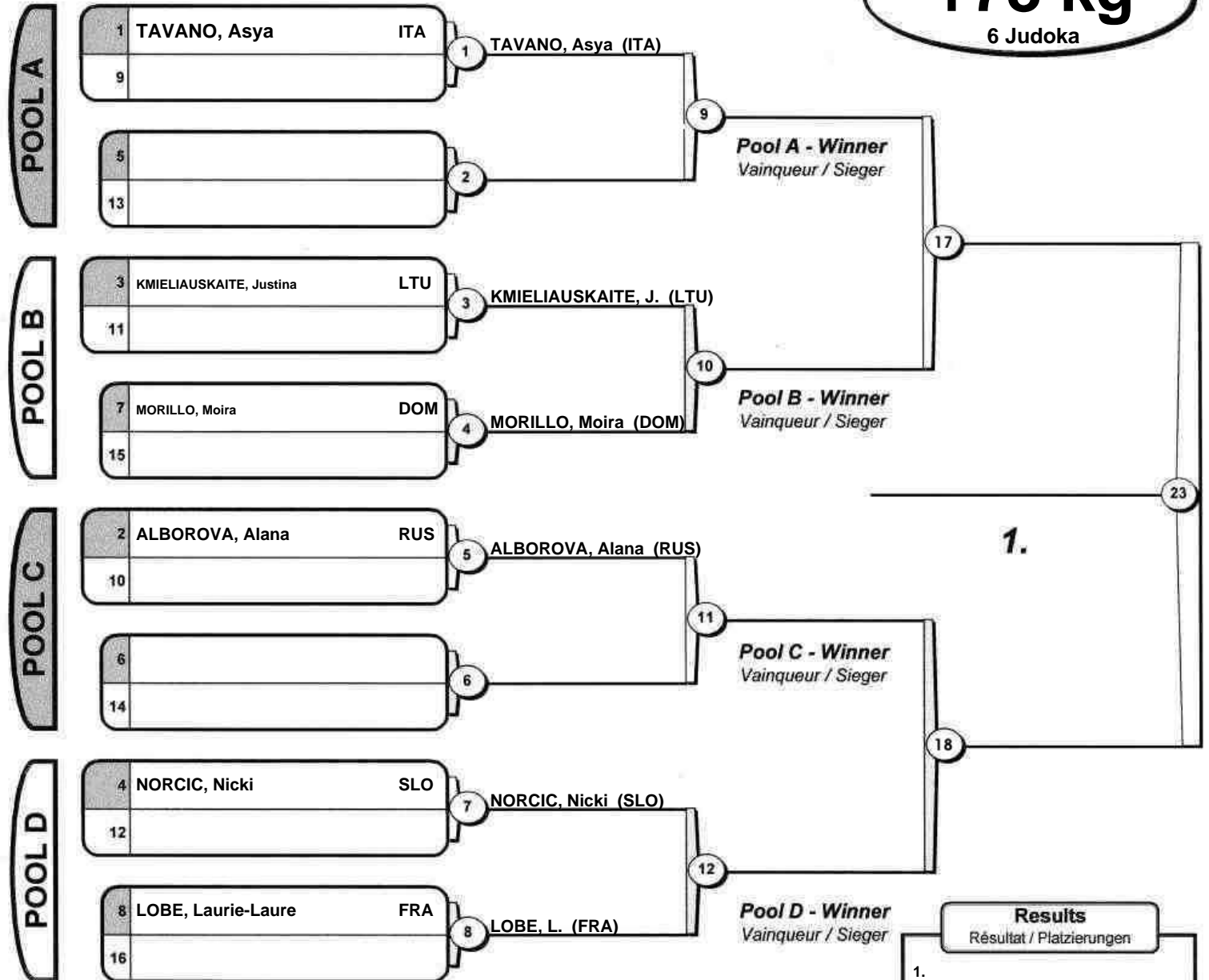

Results	
Résultat / Platzierungen	
1.	
2.	
3.	
3.	
5.	
5.	
7.	
7.	

