



# Junior European Judo Cup St. Ptersburg 2016

St. Ptersburg (RUS) 16-17 April 2016

## -55 kg

19 Judoka

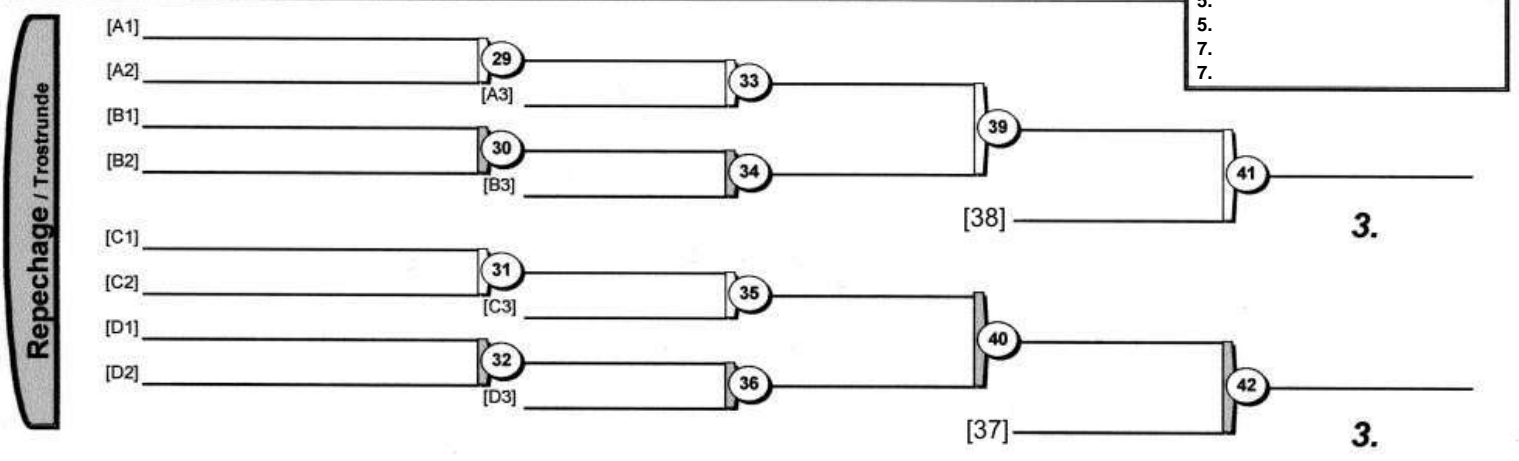
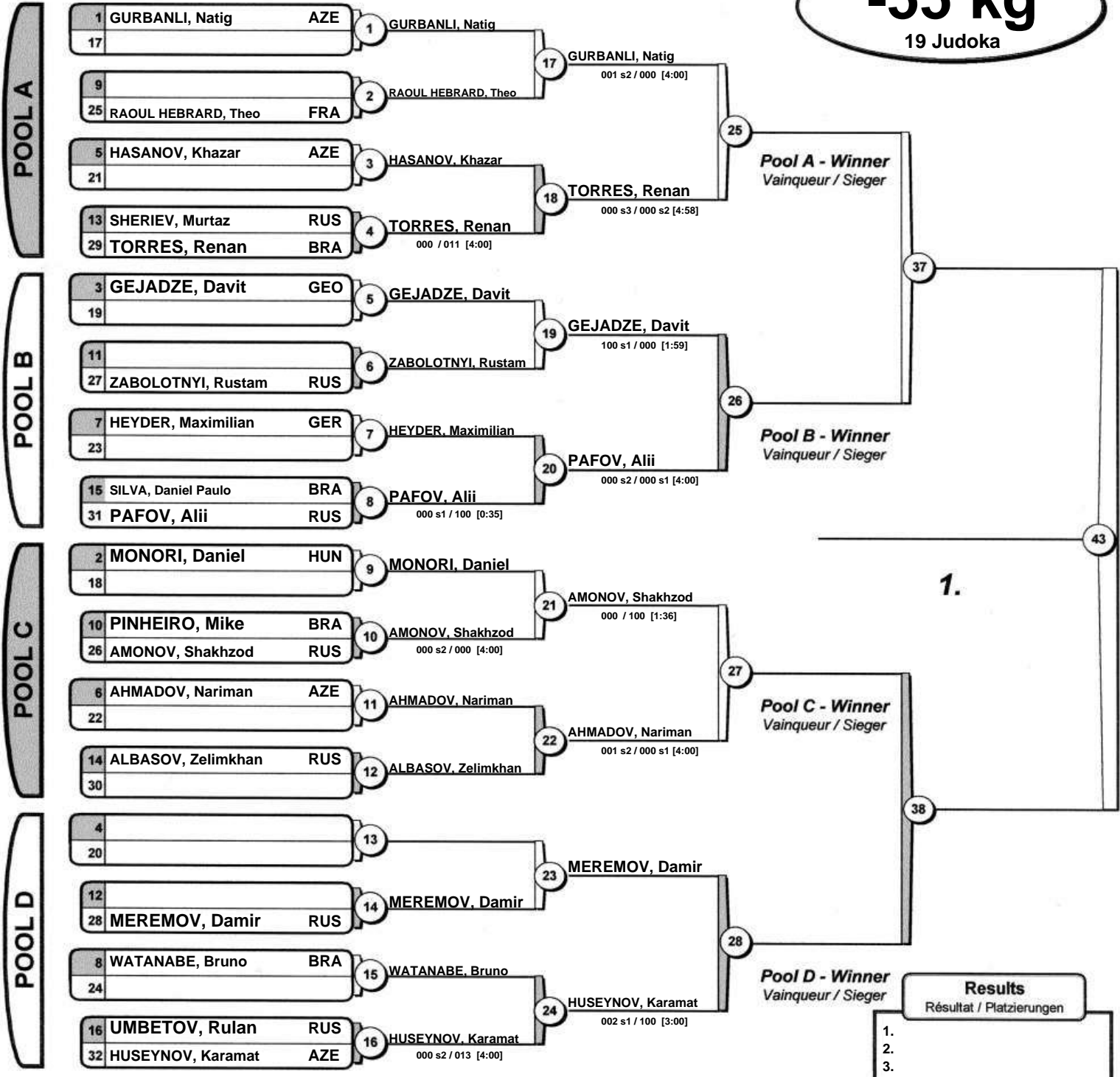



# Junior European Judo Cup St. Ptersburg 2016

St. Ptersburg (RUS) 16-17 April 2016

## -60 kg

28 Judoka

POOL A

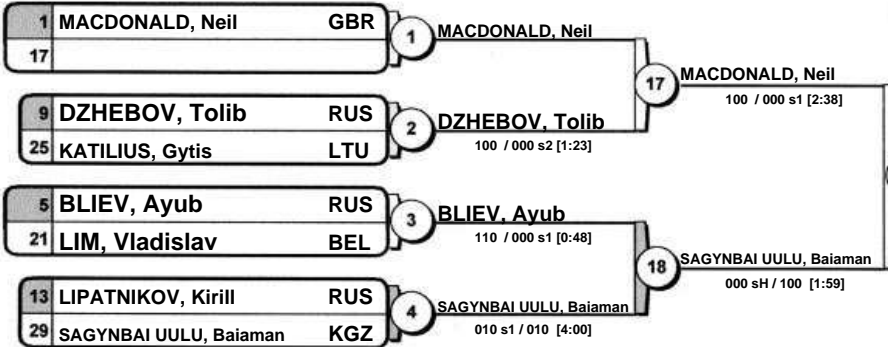

POOL B

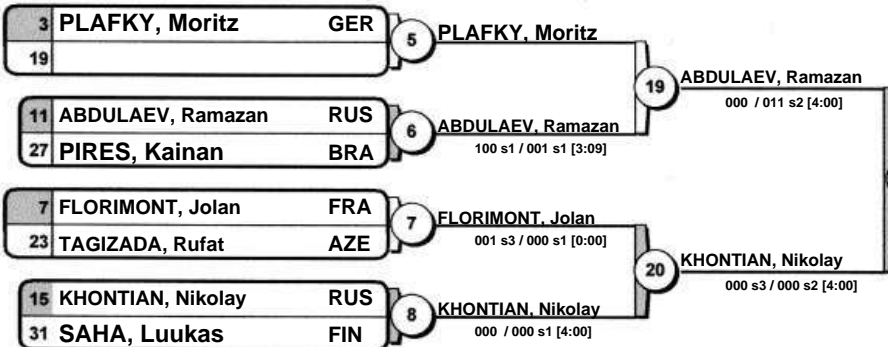

POOL C

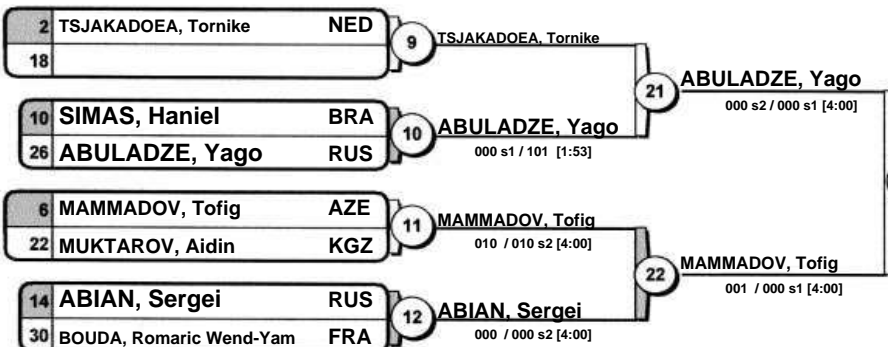

POOL D

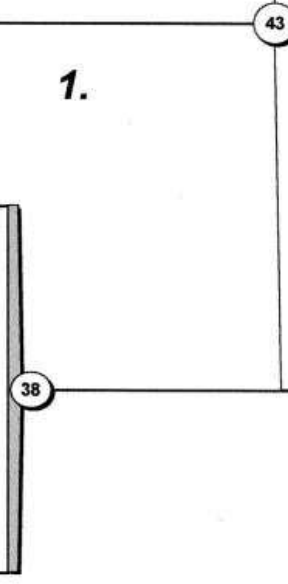
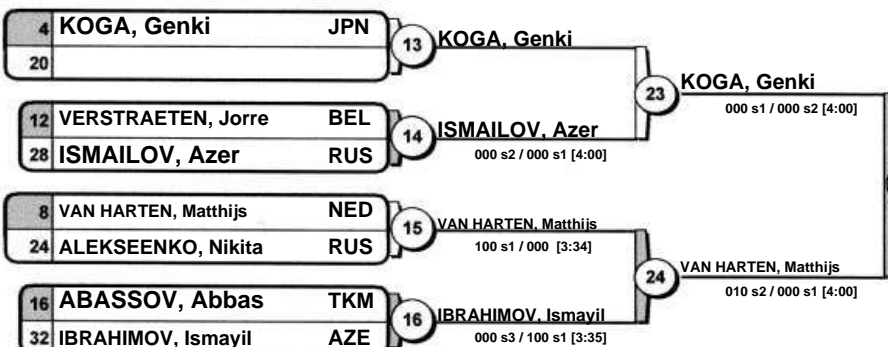

| Results                  |  |
|--------------------------|--|
| Résultat / Platzierungen |  |
| 1.                       |  |
| 2.                       |  |
| 3.                       |  |
| 3.                       |  |
| 5.                       |  |
| 7.                       |  |
| 7.                       |  |

Repechage / Trostrunde

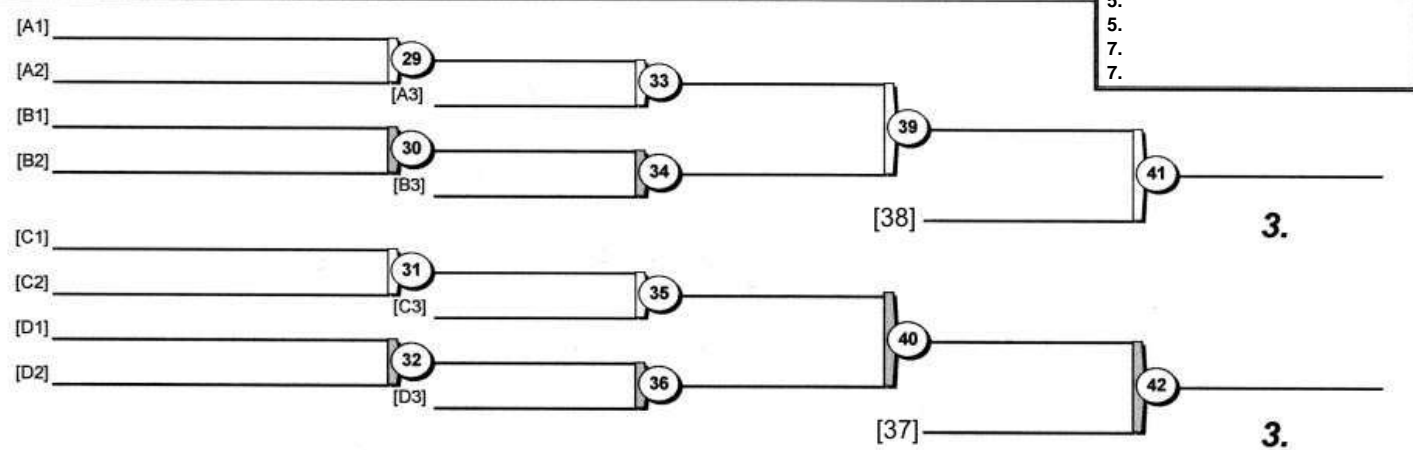



# Junior European Judo Cup St. Ptersburg 2016

St. Ptersburg (RUS) 16-17 April 2016

## -66 kg

34 Judoka

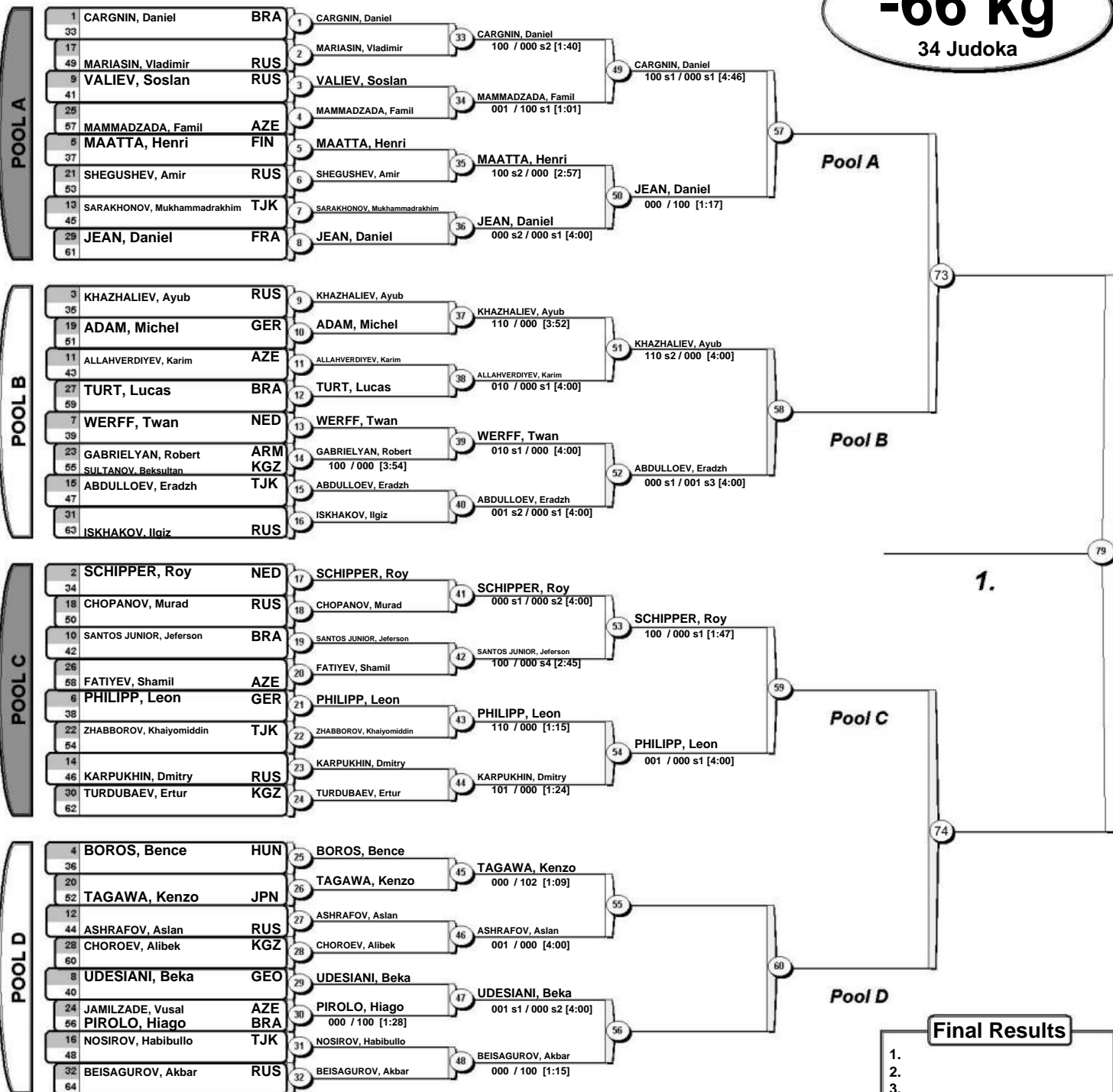

### Repechage

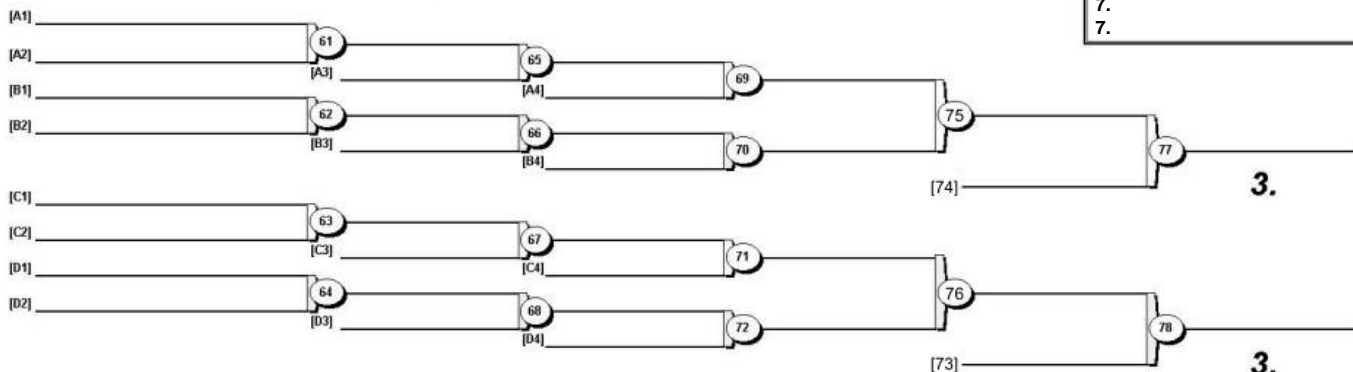



# Junior European Judo Cup St. Ptersburg 2016

St. Ptersburg (RUS) 16-17 April 2016

## -73 kg

33 Judoka

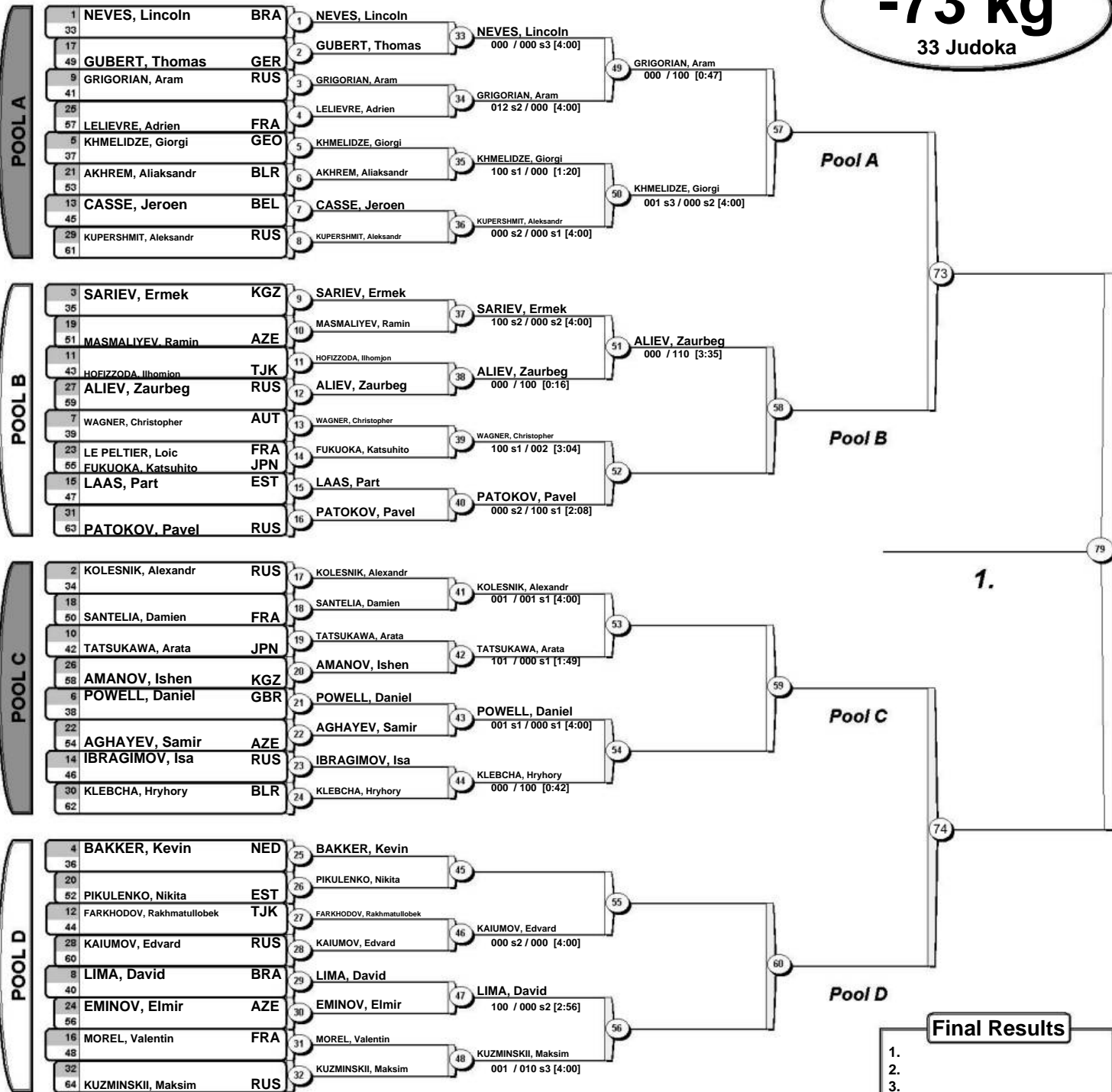

## Repechage

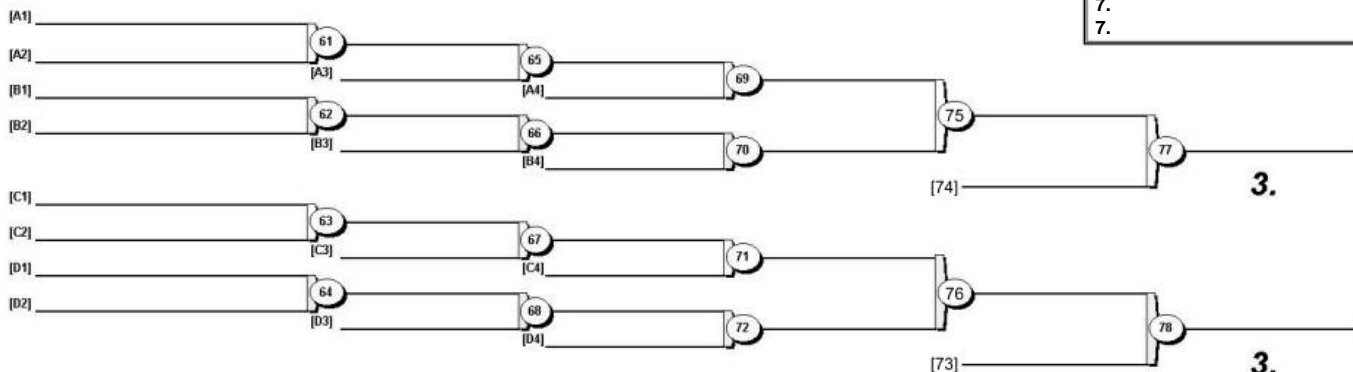



# Junior European Judo Cup St. Ptersburg 2016

St. Ptersburg (RUS) 16-17 April 2016

## -81 kg

32 Judoka

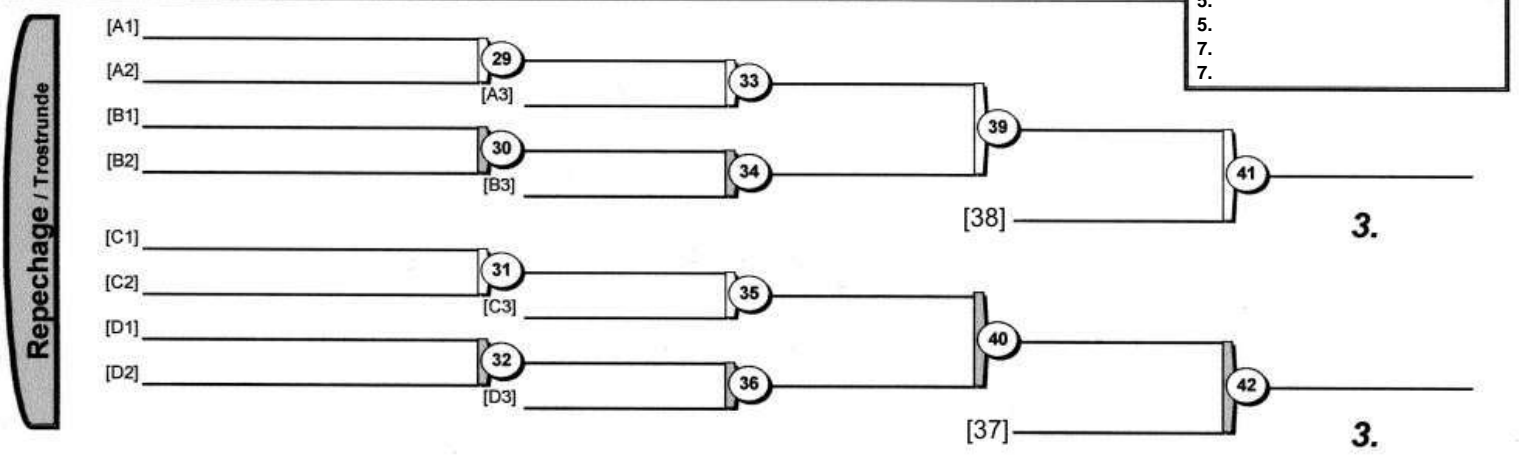
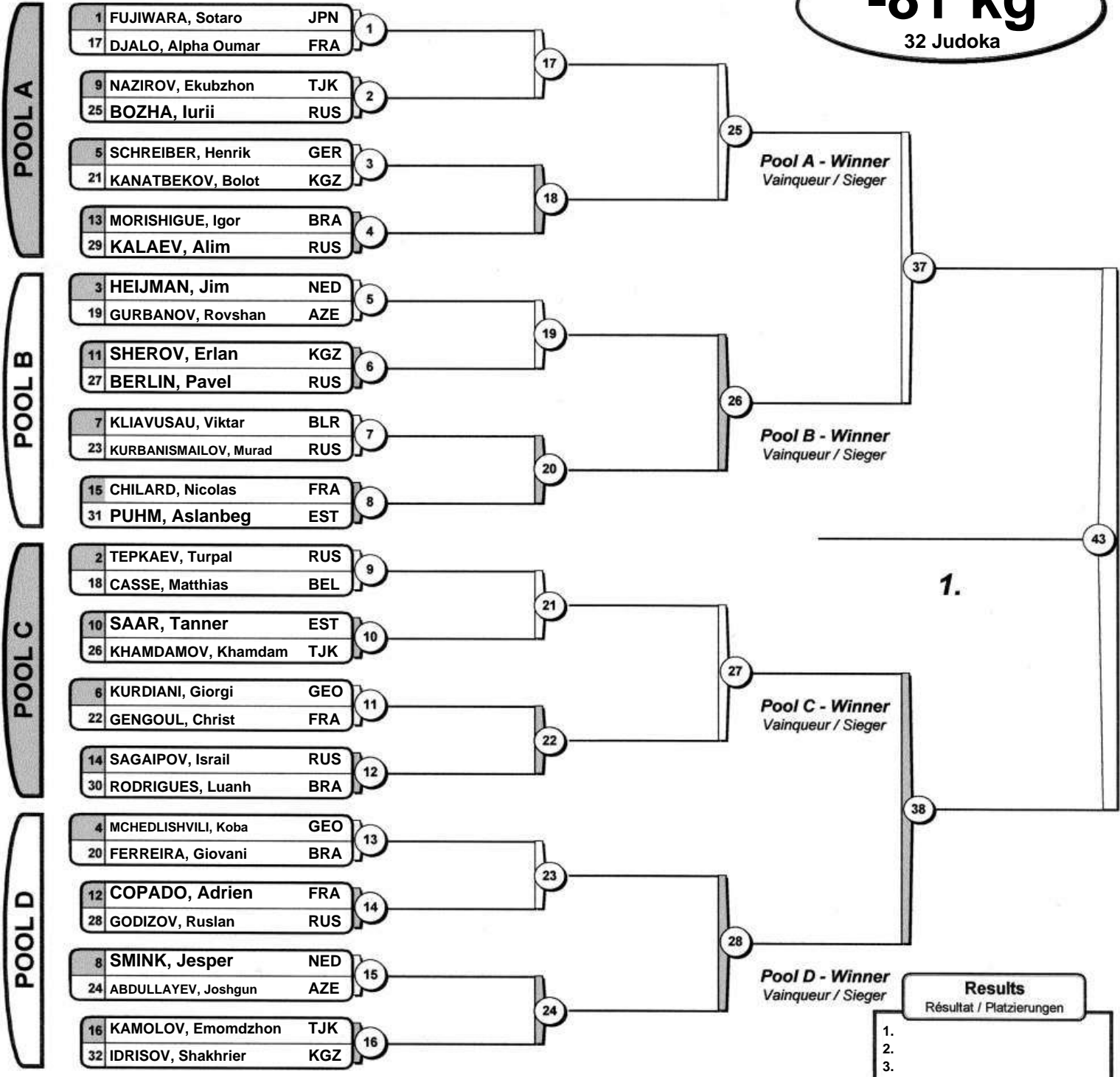



# Junior European Judo Cup St. Petersburg 2016

St. Petersburg (RUS) 16-17 April 2016

## -90 kg

31 Judoka

POOL A

1 IGOLNIKOV, Mikhail RUS 1 IGOLNIKOV, Mikhail

9 VARAPAYEU, Yahor BLR 2  
25 SAHAKYAN, Grigor ARM

5 PACHER, Johannes AUT 3  
21 RAKHMONOV, Khodzhimashrab TJK

13 TOTH, Apor HUN 4  
29 DIESSE, Aurelien FRA

POOL B

3 TRIPPEL, Eduard GER 5  
19 MIRZAYEV, Aslan AZE

11 HUMBERTO, Andre BRA 6  
27 DONTSOV, Roman RUS

7 MAKATSARIA, Sandro GER 7  
23 BAKALOV, Artem RUS

15 ISMAILOV, Tamirlan KGZ 8  
31 KVIRIKASHVILI, Ieso GEO

POOL C

2 FRANCINI, Henrique BRA 9  
18 TAIMAZOV, Inal RUS

10 ASOMIDDINI, Faiziddin TJK 10  
26 KMIELIAUSKAS, Antanas LTU

6 KUUSIK, Mattias EST 11  
22 SACHYLOVICH, Anton BLR

14 KORDELY, Peter HUN 12  
30 PALIAN, Karlen RUS

POOL D

4 MUKETE, Daniel BLR 13  
20 SCHNEIDER, Sebastian AUT

12 SNIPPE, Jelle NED 14  
28 TAIMAZOV, Robert RUS

8 HANNULA, Henri FIN 15  
24 DJERORO, Yanis FRA

16 YAGUBOV, Azar AZE 16  
32 DEMIDOV, Mikhail RUS

Pool A - Winner  
Vainqueur / Sieger

Pool B - Winner  
Vainqueur / Sieger

Pool C - Winner  
Vainqueur / Sieger

Pool D - Winner  
Vainqueur / Sieger

1.

Results  
Résultat / Platzierungen

- 1.
- 2.
- 3.
- 3.
- 5.
- 7.
- 7.

Repechage / Trostrunde

[A1] \_\_\_\_\_ 29 \_\_\_\_\_ 33

[B1] \_\_\_\_\_ 30 \_\_\_\_\_ 34

[C1] \_\_\_\_\_ 31 \_\_\_\_\_ 35

[D1] \_\_\_\_\_ 32 \_\_\_\_\_ 36

3.

3.



# Junior European Judo Cup St. Ptersburg 2016

St. Ptersburg (RUS) 16-17 April 2016

## -100 kg

29 Judoka

POOL A

1 GONCALVES, Leonardo BRA 1 GONCALVES, Leonardo

9 LUDVIG, Sander EST 2  
25 ABDUKADIROV, Ilman RUS

5 OZBETELASHVILI, David GEO 3  
21 PETKUS, Romas LTU

13 LEPEKHA, Aleksei RUS 4  
29 SHAKARALIYEV, Musa AZE

POOL B

3 SVIRYD, Mikita BLR 5  
19 ZORN, Daniel GER

11 ADAMIAN, Arman RUS 6  
27 KOTSOIEV, Zelym AZE

7 CATHARINA, Simeon NED 7  
23 AMINOV, Murtazo TJK

15 SILVA, Arthur BRA 8  
31 SVIATSKII, Petr RUS

POOL C

2 KUNSZABO, Luca ROU 9 KUNSZABO, Luca

10 DIGUROV, Alan RUS 10  
26 RAKHIMOV, Temur TJK

6 FARA, Aaron AUT 11  
22 KLIUCHNIKAU, Pavel BLR

14 JUSUFI, Milot GER 12  
30 UMAROV, Akhmed RUS

POOL D

4 MUMLADZE, Jaba GEO 13 MUMLADZE, Jaba

12 DZHIOEV, Aslan RUS 14  
28 IIDA, Kentaro JPN

8 FREY, Johannes GER 15  
24 PLESHAKOV, Vitalii RUS

16 MAHARRAMOV, Mahammad AZE 16  
32 JUNIOR, William BRA

Repechage / Trostrunde

[A1] \_\_\_\_\_ 29 \_\_\_\_\_ 33

[B1] \_\_\_\_\_ 30 \_\_\_\_\_ 34

[C1] \_\_\_\_\_ 31 \_\_\_\_\_ 35

[D1] \_\_\_\_\_ 32 \_\_\_\_\_ 36

Pool A - Winner  
Vainqueur / Sieger

Pool B - Winner  
Vainqueur / Sieger

Pool C - Winner  
Vainqueur / Sieger

Pool D - Winner  
Vainqueur / Sieger

1.

Results  
Résultat / Platzierungen

- 1.
- 2.
- 3.
- 3.
- 5.
- 7.
- 7.

3.

3.



# Junior European Judo Cup St. Ptersburg 2016

St. Ptersburg (RUS) 16-17 April 2016

## +100 kg

14 Judoka

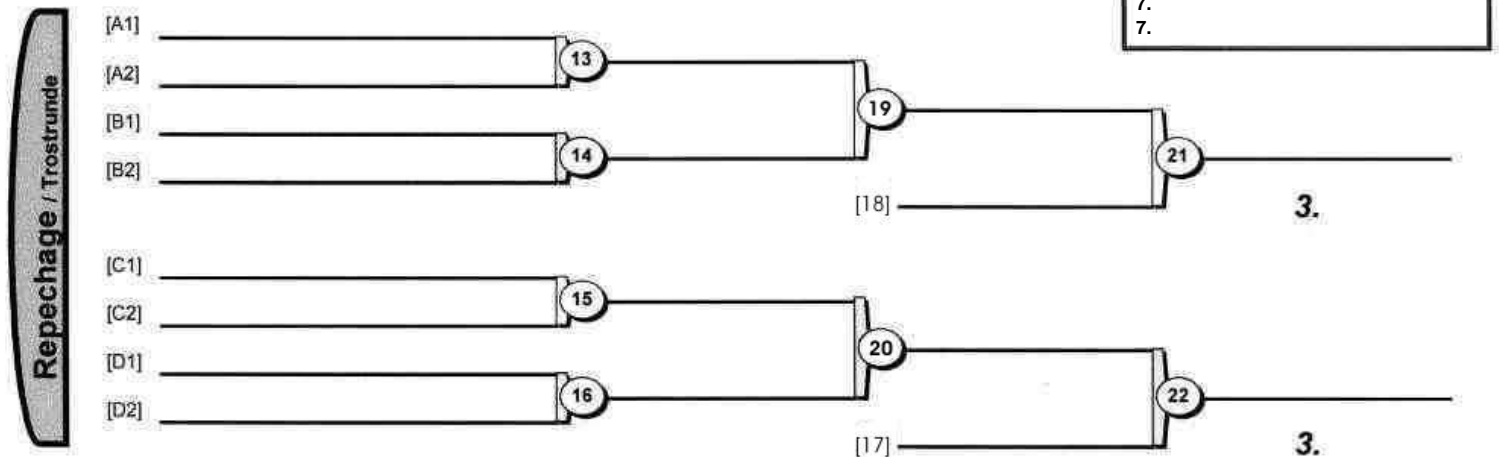
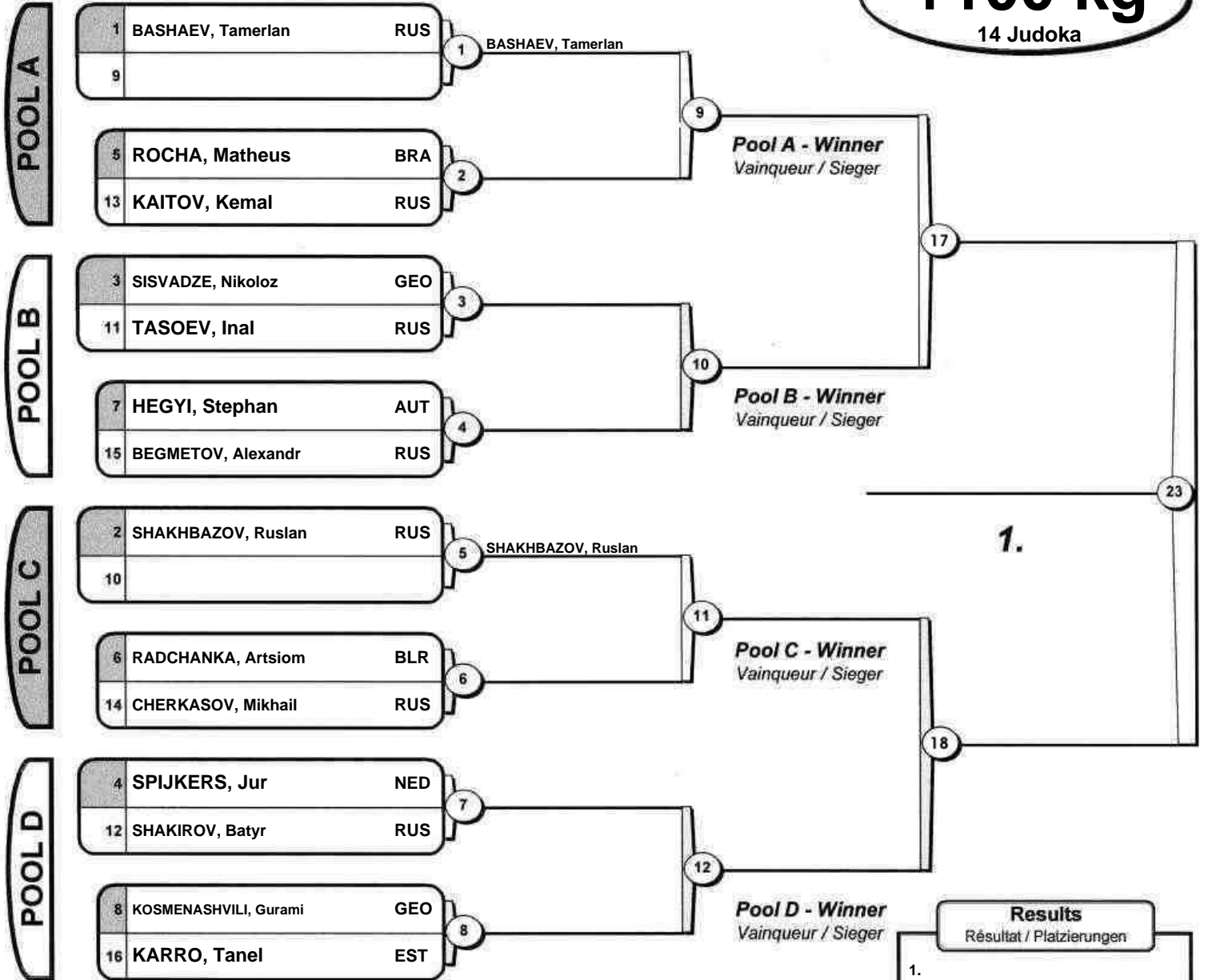





# Junior European Judo Cup St. Petersburg 2016

St. Petersburg (RUS) 16-17 April 2016

## -44 kg

10 Judoka

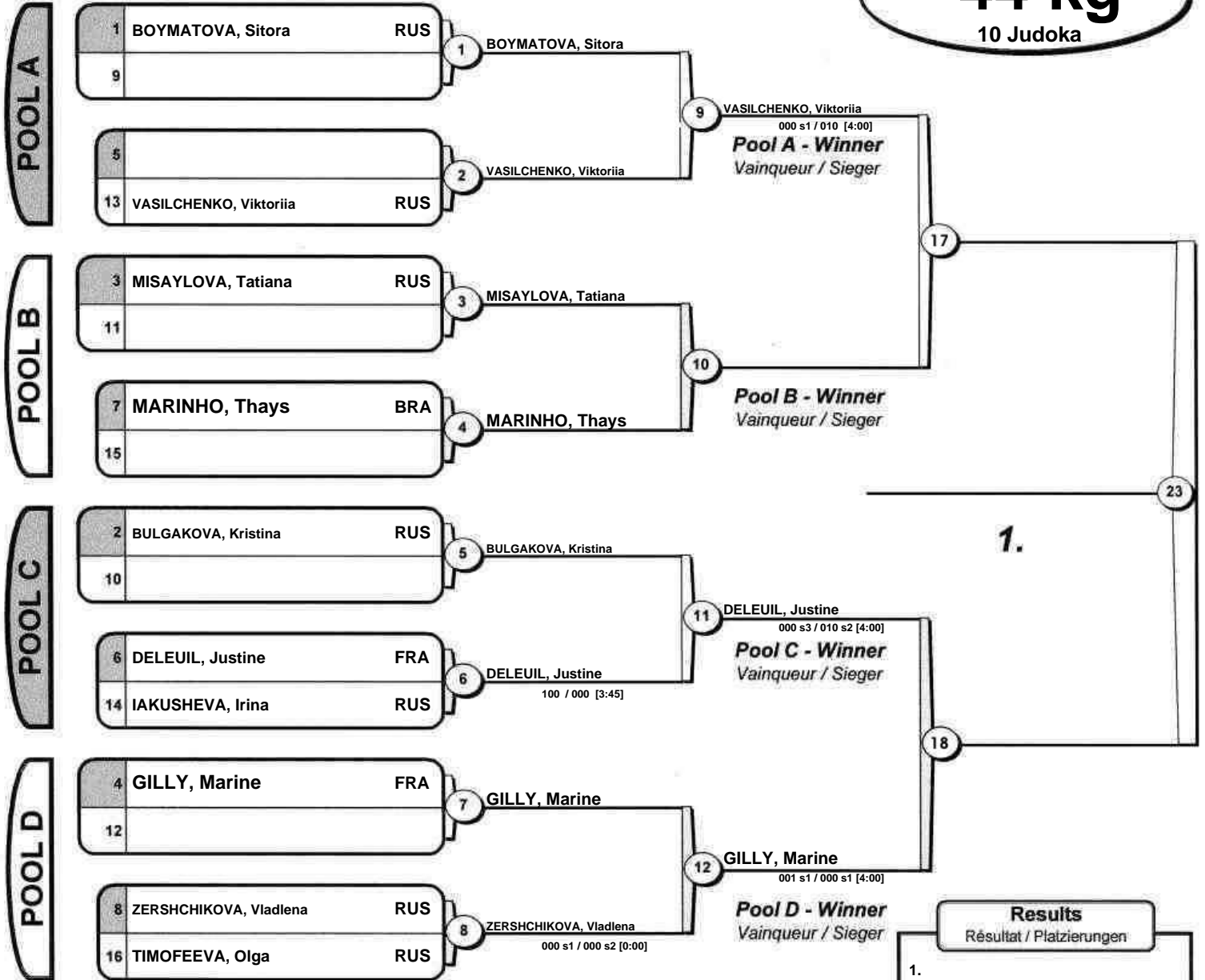

| Results                  |  |
|--------------------------|--|
| Résultat / Platzierungen |  |
| 1.                       |  |
| 2.                       |  |
| 3.                       |  |
| 3.                       |  |
| 5.                       |  |
| 5.                       |  |
| 7.                       |  |
| 7.                       |  |

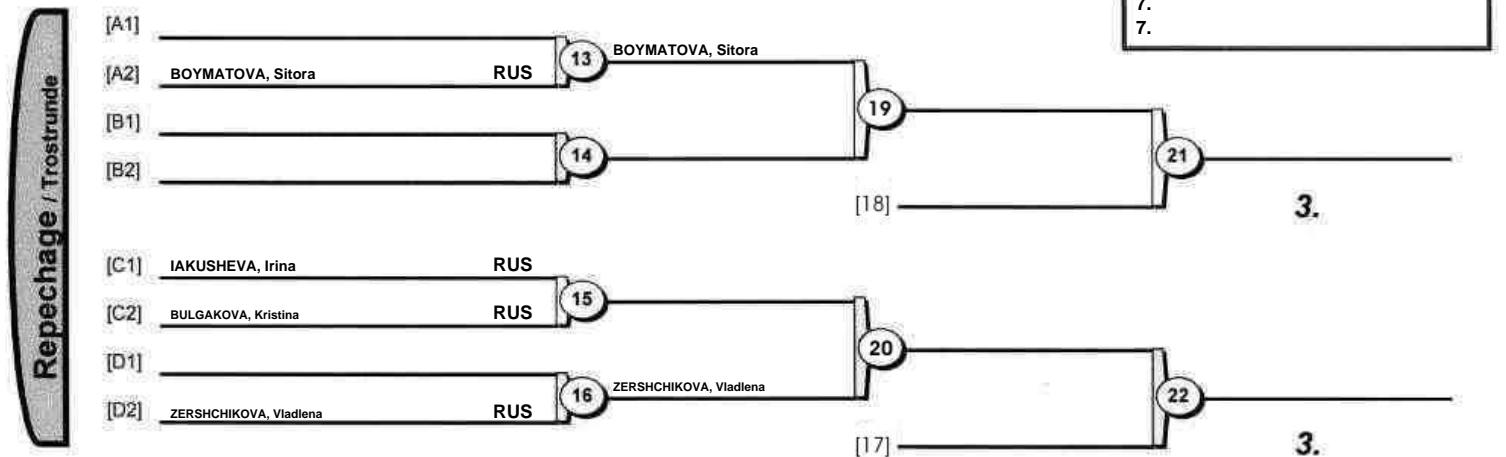



# Junior European Judo Cup St. Ptersburg 2016

St. Ptersburg (RUS) 16-17 April 2016

## -48 kg

16 Judoka

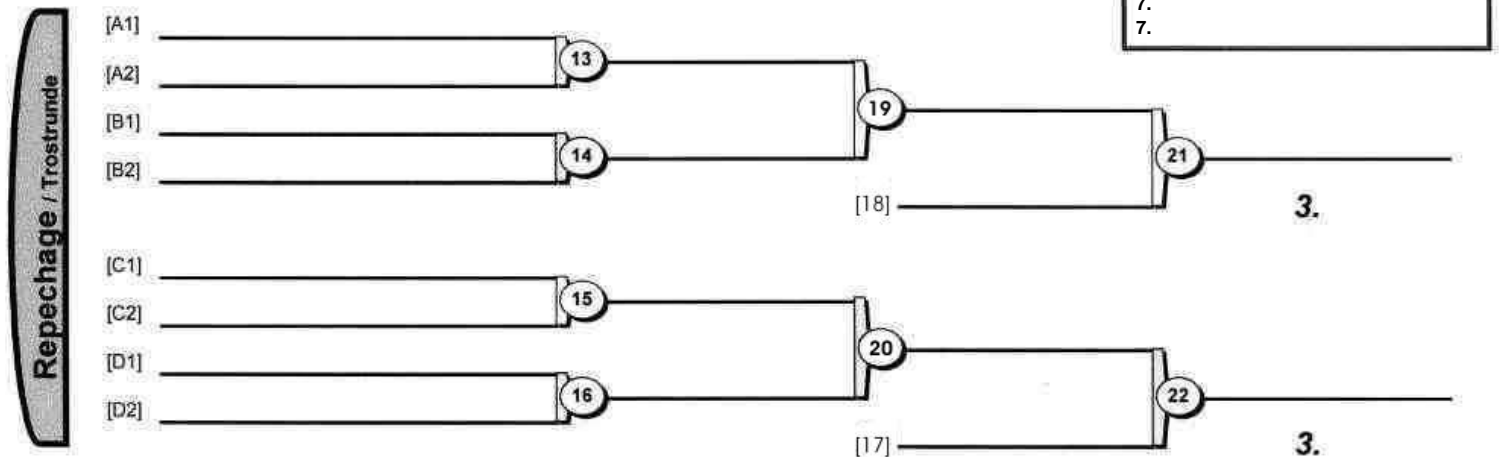
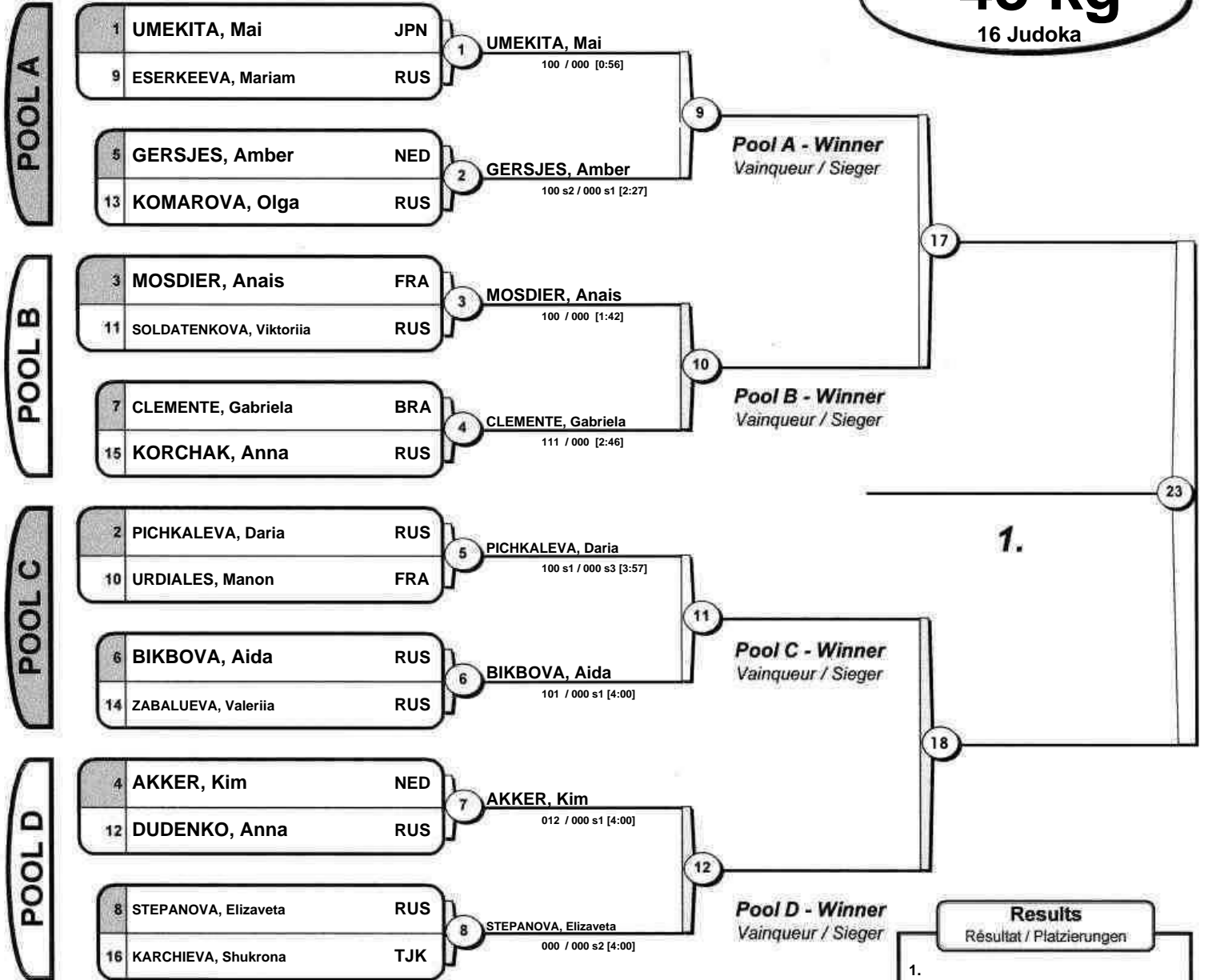



# Junior European Judo Cup St. Ptersburg 2016

St. Ptersburg (RUS) 16-17 April 2016

## -52 kg

14 Judoka

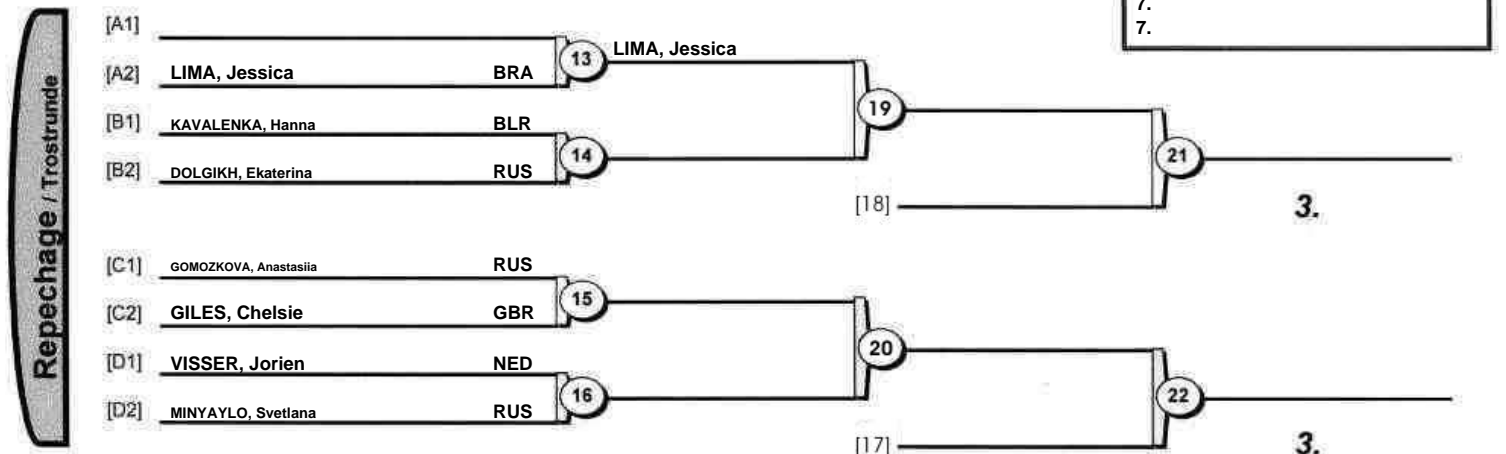
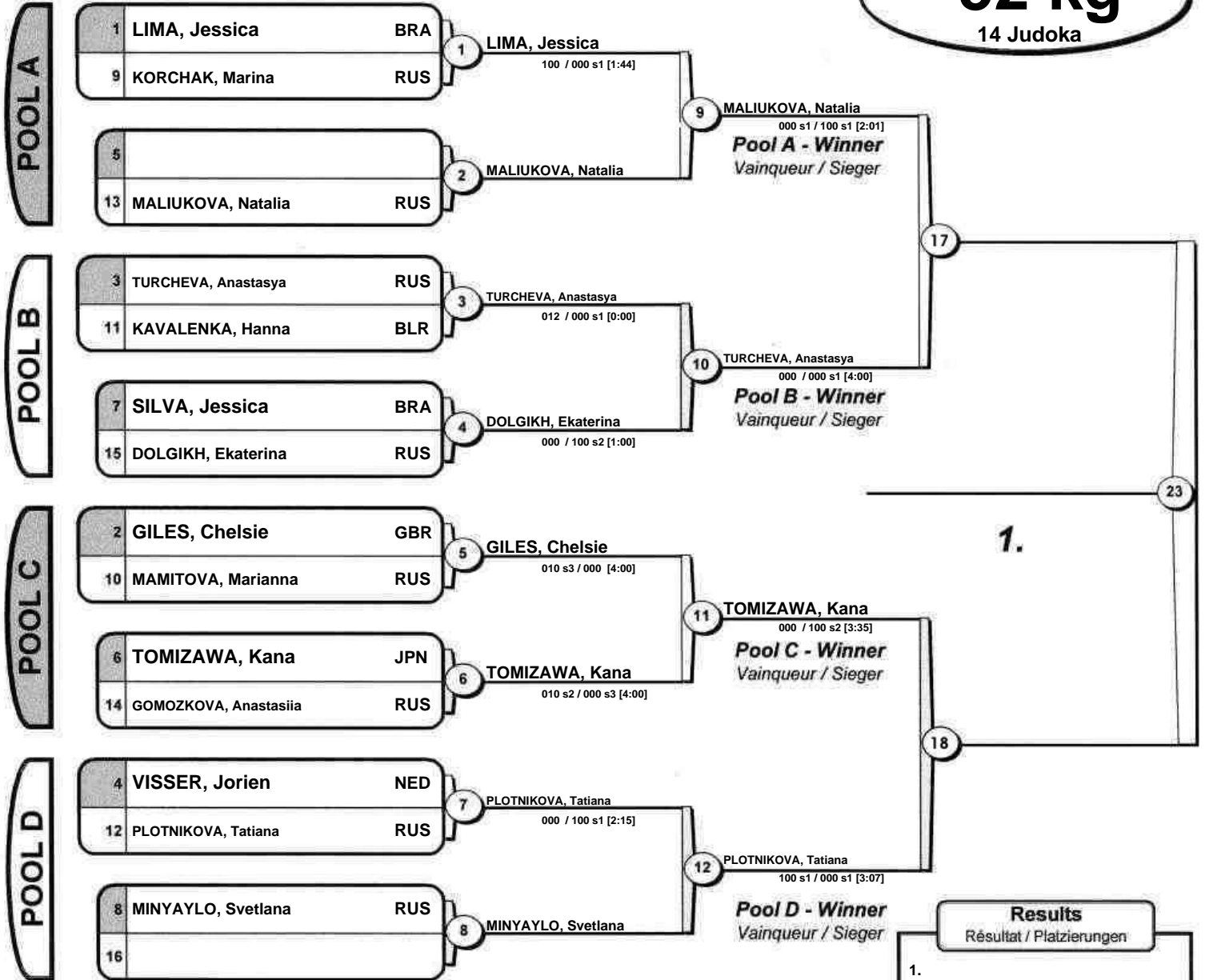



# Junior European Judo Cup St. Ptersburg 2016

St. Ptersburg (RUS) 16-17 April 2016

## -57 kg

21 Judoka

POOL A



**Pool A - Winner**  
Vainqueur / Sieger

POOL B

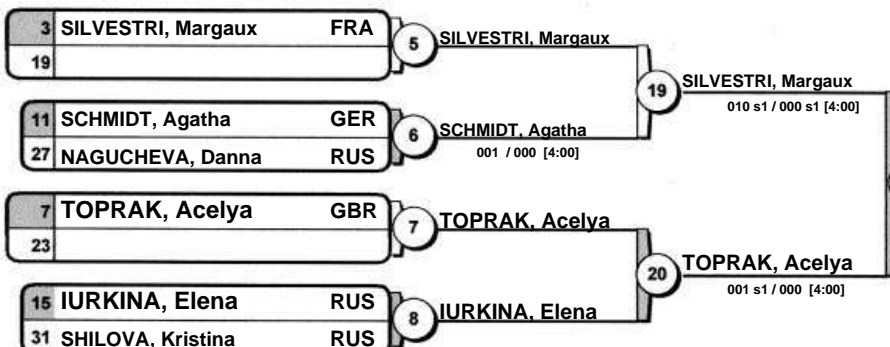

**Pool B - Winner**  
Vainqueur / Sieger

POOL C

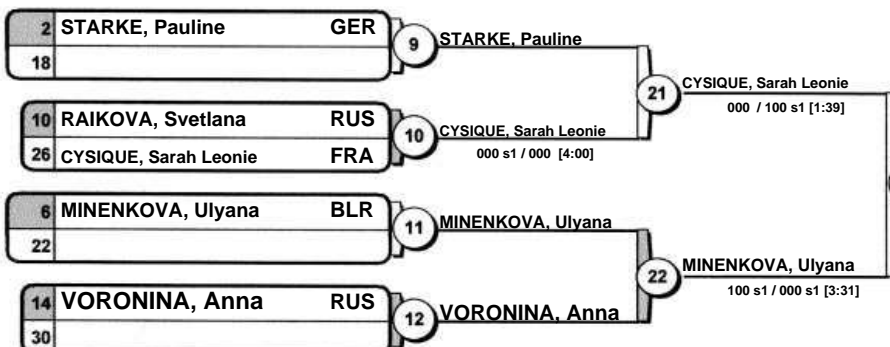

**Pool C - Winner**  
Vainqueur / Sieger

POOL D



**Pool D - Winner**  
Vainqueur / Sieger



**Results**  
Résultat / Platzierungen

- 1.
- 2.
- 3.
- 3.
- 5.
- 7.
- 7.

Repechage / Trostrunde

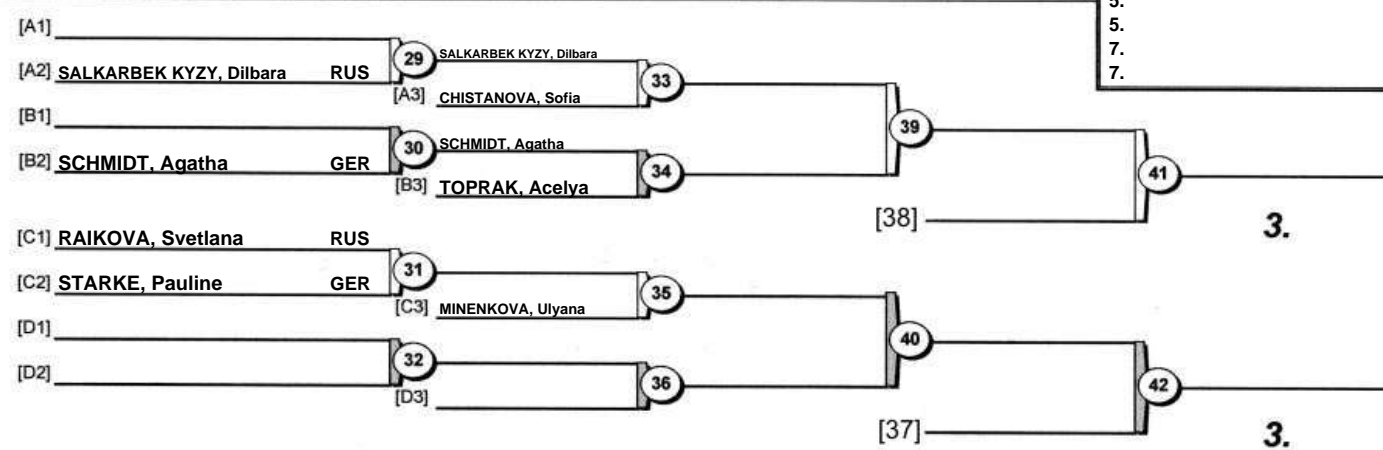



# Junior European Judo Cup St. Ptersburg 2016

St. Ptersburg (RUS) 16-17 April 2016

## -63 kg

19 Judoka

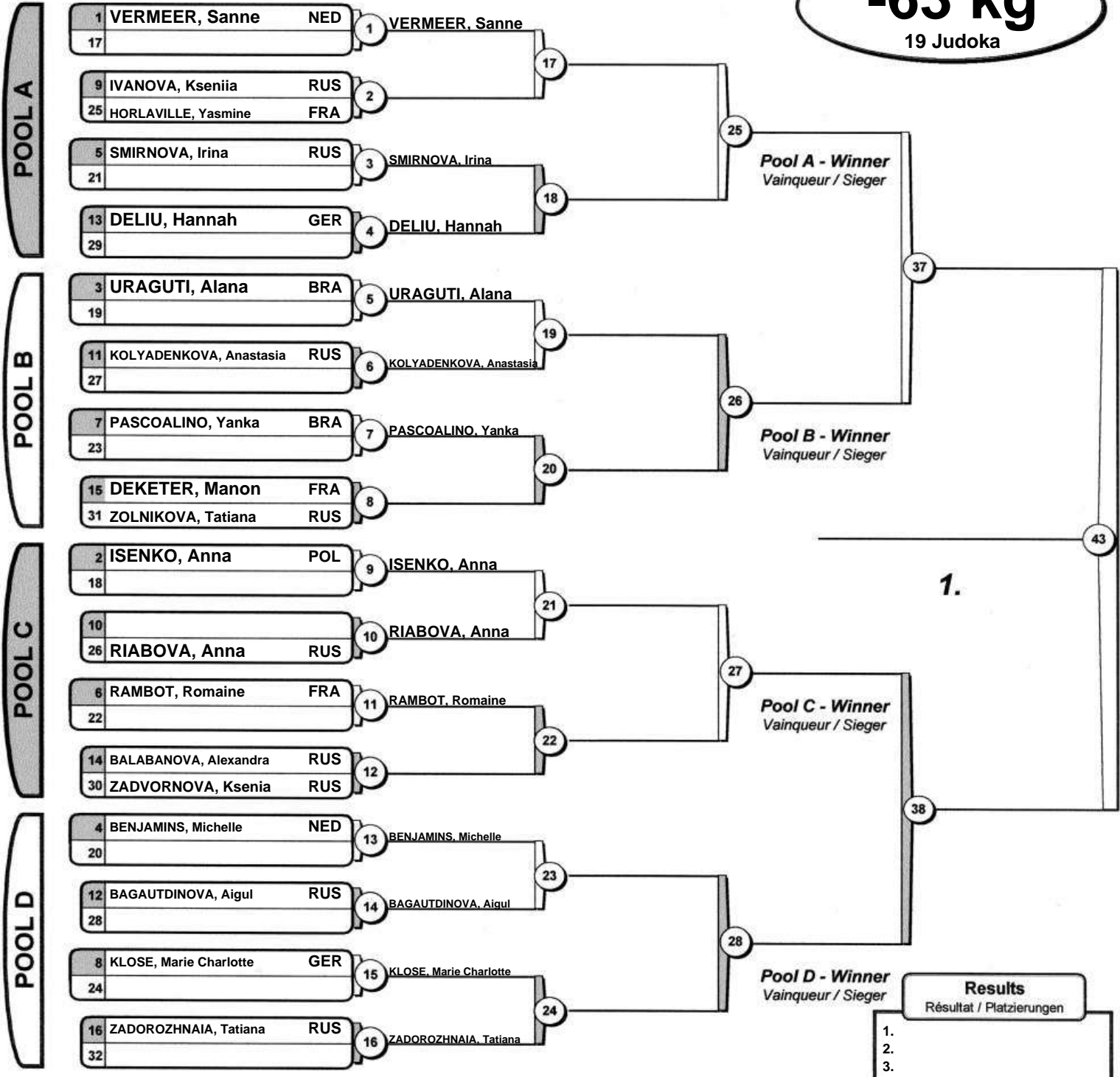

1.

**Results**  
Résultat / Platzierungen

- 1.
- 2.
- 3.
- 3.
- 5.
- 7.
- 7.

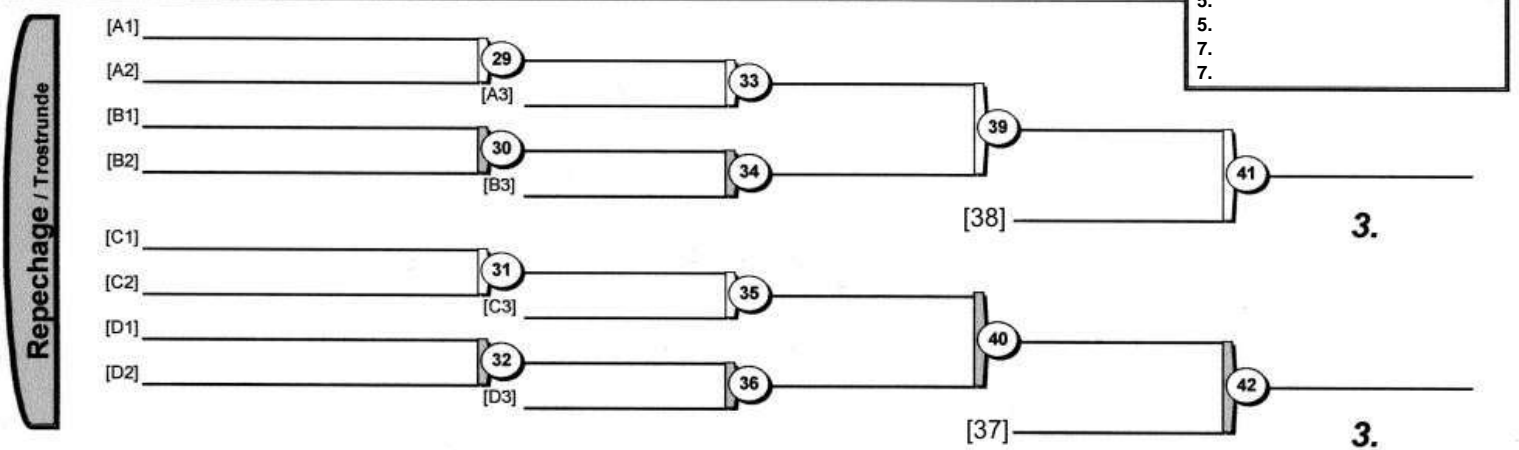

3.

3.



# Junior European Judo Cup St. Ptersburg 2016

St. Ptersburg (RUS) 16-17 April 2016

## -70 kg

20 Judoka

POOL A

1 AUSMA, Natascha NED  
17

1 AUSMA, Natascha

17

9 SAIAPINA, Violetta RUS  
25 MILLER, Karolina POL

2

5 TARTING, Juliette FRA  
21

3 TARTING, Juliette

18

13  
29 AKSENOVA, Tatiana RUS

4 AKSENOVA, Tatiana

POOL B

3 BLIETZ, Johanna GER  
19

5 BLIETZ, Johanna

19

11 NESI, Bruna BRA  
27 BONDARENKO, Valeriya RUS

6

7 OLARTE, Marina FRA  
23

7 OLARTE, Marina

20

15  
31 KAMALOVA, Elvira RUS

8 KAMALOVA, Elvira

POOL C

2 AOYAGI, Remi JPN  
18

9 AOYAGI, Remi

21

10 RIABCHENKO, Margarita RUS  
26 SILVA, Bruna BRA

10

6 VOS, Donja NED  
22

11 VOS, Donja

22

14  
30 KESMEN, Sara GER

12 KESMEN, Sara

POOL D

4 SCOCCIMARRO, Giovanna GER  
20

13 SCOCCIMARRO, Giovanna

23

12  
28 TIBILOVA, Dana RUS

14 TIBILOVA, Dana

28

8 TOKAREVA, Ekaterina N RUS  
24

15 TOKAREVA, Ekaterina N

24

16 LORINC, Renata HUN  
32 DEVITRY, Agathe FRA

16

Pool A - Winner  
Vainqueur / Sieger

Pool B - Winner  
Vainqueur / Sieger

Pool C - Winner  
Vainqueur / Sieger

Pool D - Winner  
Vainqueur / Sieger

1.

Results  
Résultat / Platzierungen

- 1.
- 2.
- 3.
- 3.
- 5.
- 7.
- 7.

Repechage / Trostrunde

[A1]

[A2]

29

[A3]

33

[B1]

[B2]

30

[B3]

34

[38]

[C1]

[C2]

31

[C3]

35

[D1]

[D2]

32

[D3]

36

[37]

3.

3.



# Junior European Judo Cup St. Petersburg 2016

St. Petersburg (RUS) 16-17 April 2016

## -78 kg

12 Judoka

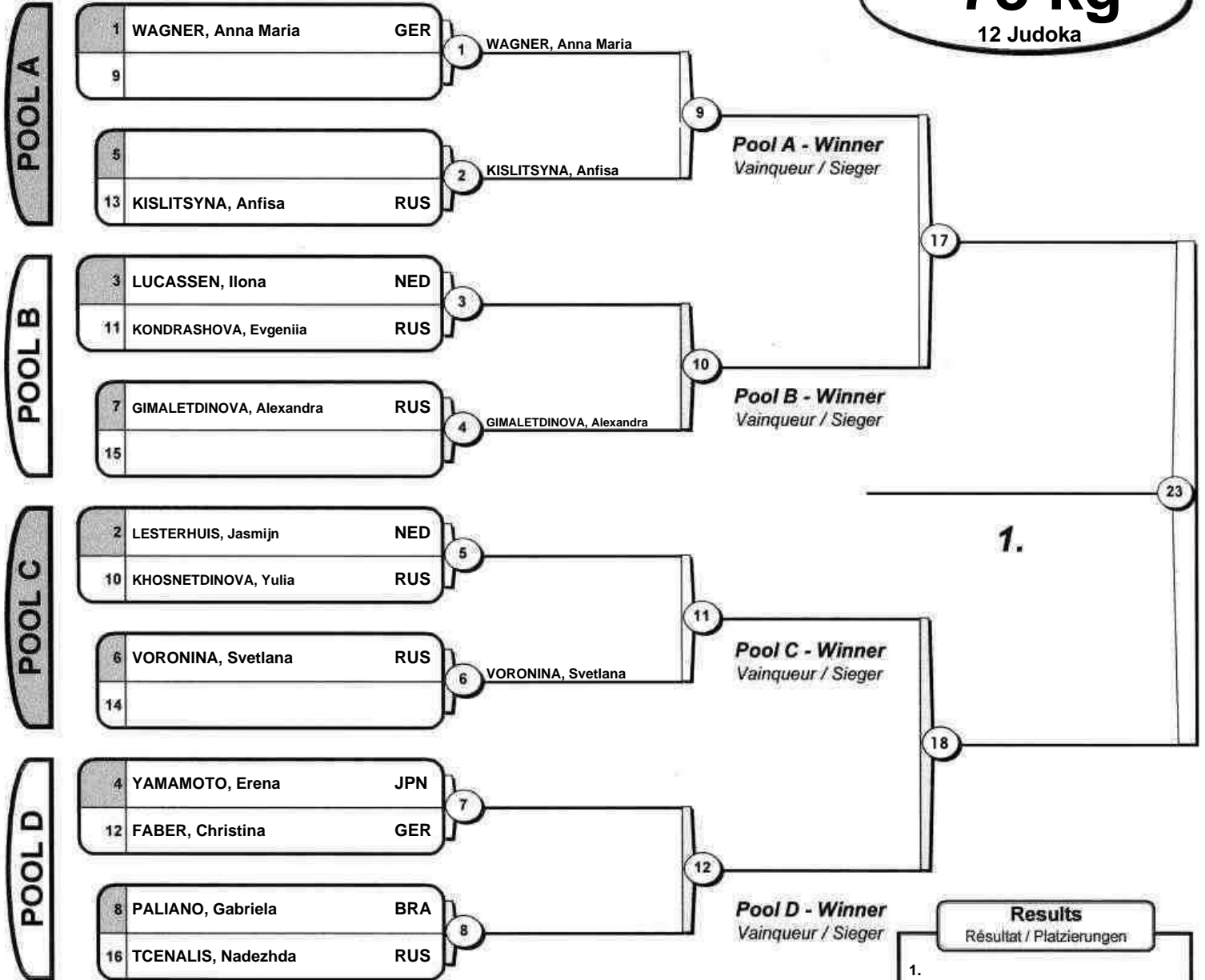

| Results                  |  |
|--------------------------|--|
| Résultat / Platzierungen |  |
| 1.                       |  |
| 2.                       |  |
| 3.                       |  |
| 3.                       |  |
| 5.                       |  |
| 5.                       |  |
| 7.                       |  |
| 7.                       |  |

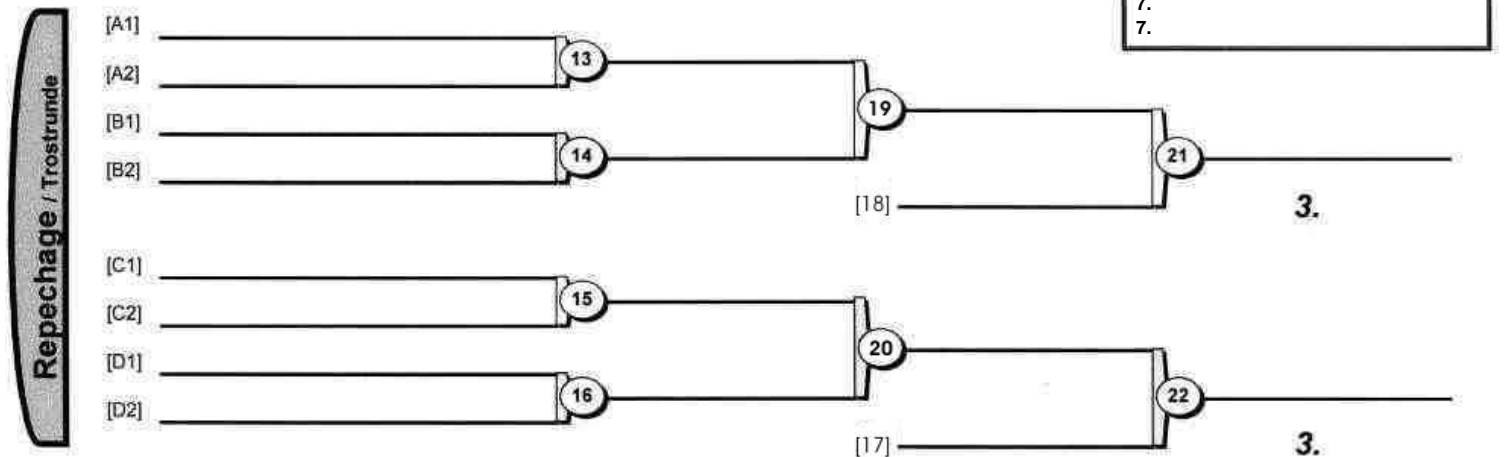



# Junior European Judo Cup St. Ptersburg 2016

St. Ptersburg (RUS) 16-17 April 2016

## +78 kg

14 Judoka

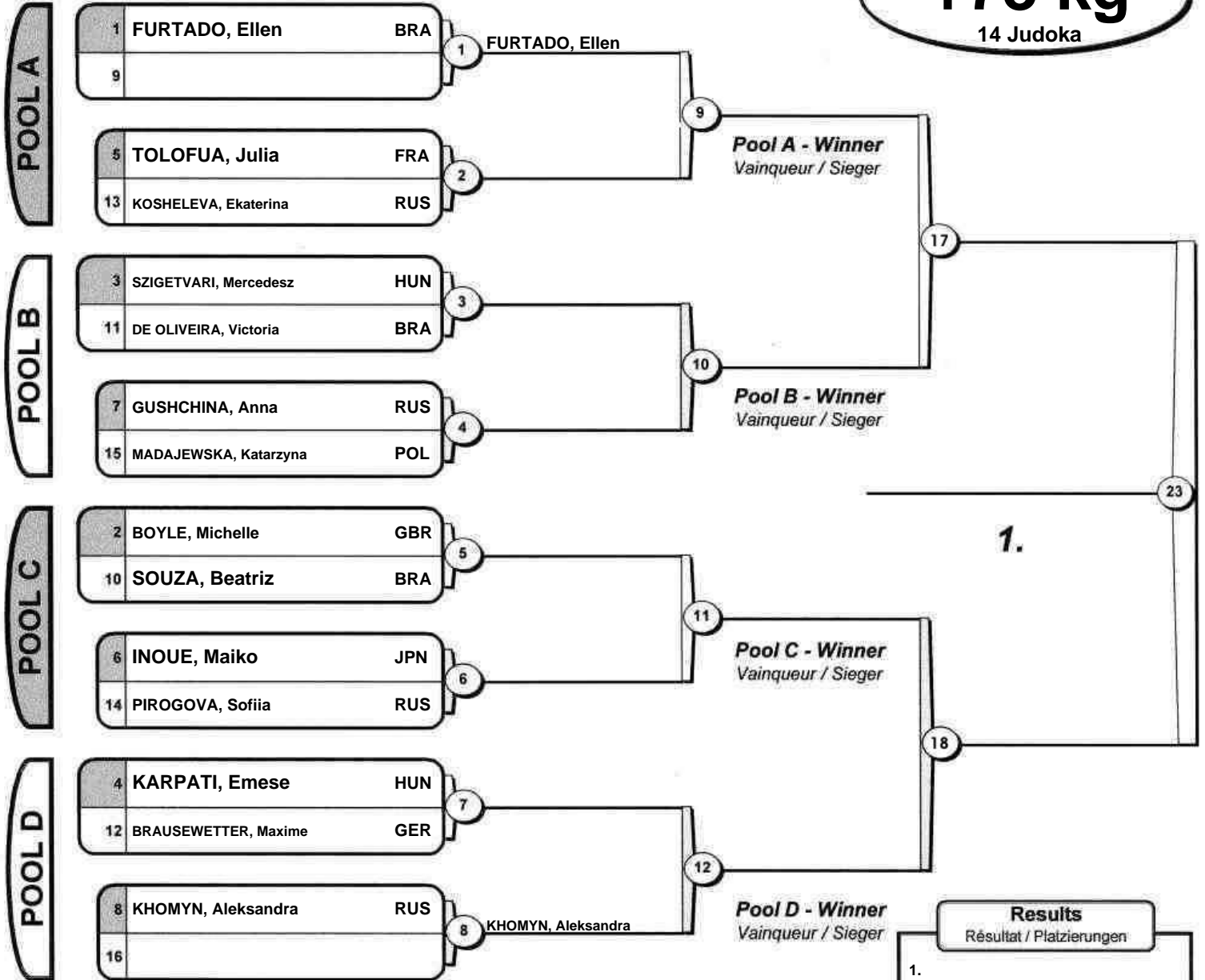

| Results                  |  |
|--------------------------|--|
| Résultat / Platzierungen |  |
| 1.                       |  |
| 2.                       |  |
| 3.                       |  |
| 3.                       |  |
| 5.                       |  |
| 5.                       |  |
| 7.                       |  |
| 7.                       |  |

