

Dubrovnik Senior European Cup 2020

Dubrovnik (CRO), 03-04 Oct 2020

-60 kg

4 Judoka

			1	2	3	4			
1	STARKEK, David	SLO		1 (10)	1 (10)	0	2 (20)		
2	ZOROTOVIC, Nikola	CRO	0		0	0	0 (0)		
3	MILIC, Nemanja	SRB	0	1 (1)		1 (10)	2 (11)		
4	KRSMANOVIC, Pavle	SRB	1 (1)	1 (10)	0		2 (11)		

1	STARKEK, David	SLO	1	STARKEK, David		SLO
2	ZOROTOVIC, Nikola	CRO		10 / 00	1:42	

3	MILIC, Nemanja	SRB	2	MILIC, Nemanja		SRB
4	KRSMANOVIC, Pavle	SRB		11 s1 / 00 s2	3:40	

1	STARKEK, David	SLO	3	STARKEK, David		SLO
3	MILIC, Nemanja	SRB		10 / 01	1:17	

2	ZOROTOVIC, Nikola	CRO	4	KRSMANOVIC, Pavle		SRB
4	KRSMANOVIC, Pavle	SRB		01 s1 / 10 s1	2:46	

1	STARKEK, David	SLO	5	KRSMANOVIC, Pavle		SRB
4	KRSMANOVIC, Pavle	SRB		00 / 01	4:00	

2	ZOROTOVIC, Nikola	CRO	6	MILIC, Nemanja		SRB
3	MILIC, Nemanja	SRB		00 s1 / 01 s2	4:30	

Final Results

1. STARKEK, David SLO
2. MILIC, Nemanja SRB
3. KRSMANOVIC, Pavle SRB

Dubrovnik Senior European Cup 2020

Dubrovnik (CRO), 03-04 Oct 2020

-66 kg

11 Judoka

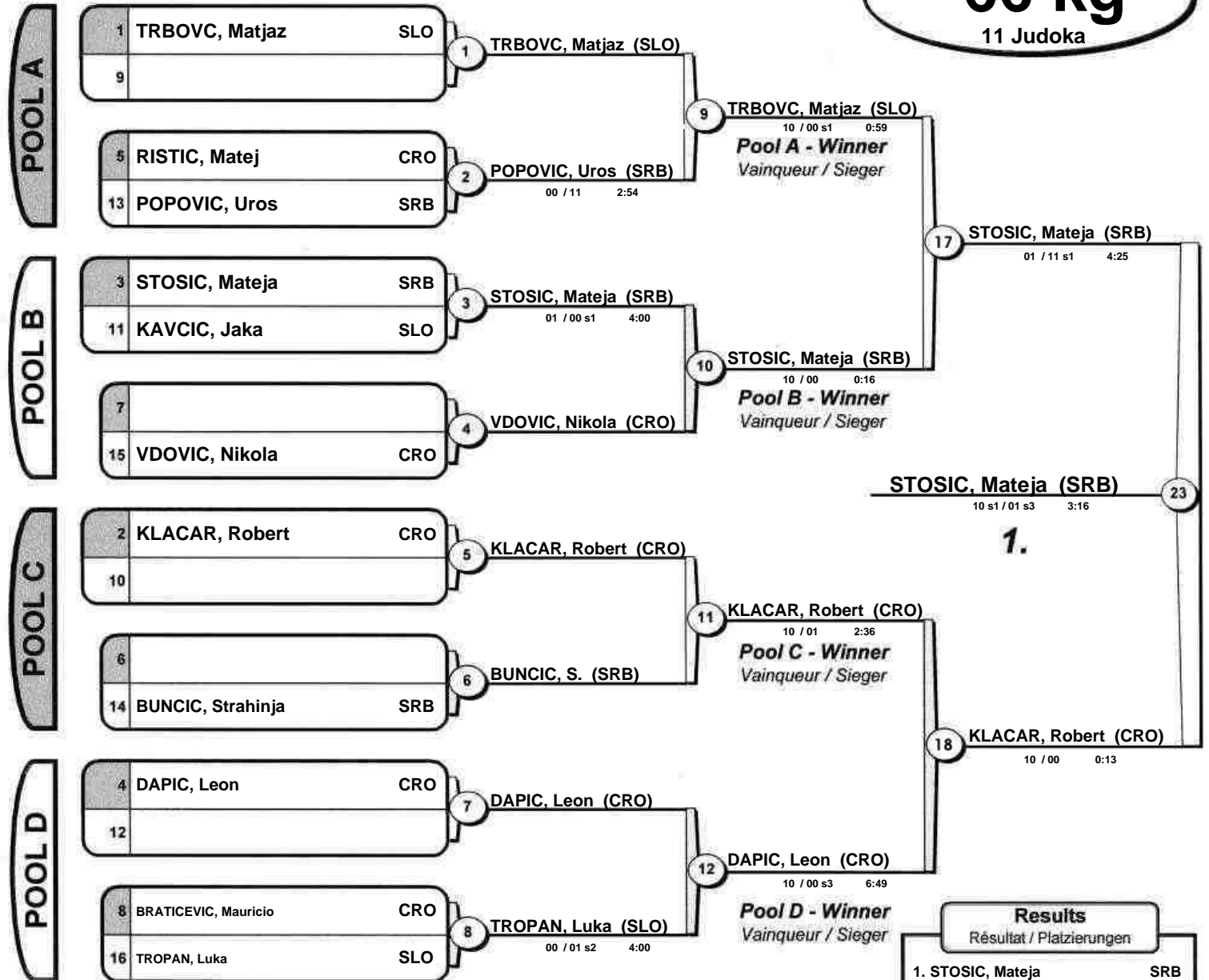

Results	
Résultat / Platzierungen	
1.	STOSIC, Mateja (SRB)
2.	KLACAR, Robert (CRO)
3.	KAVCIC, Jaka (SLO)
3.	TRBOVC, Matjaz (SLO)
5.	DAPIC, Leon (CRO)
5.	TROPAN, Luka (SLO)
7.	POPOVIC, Uros (SRB)
7.	BUNCIC, Strahinja (SRB)

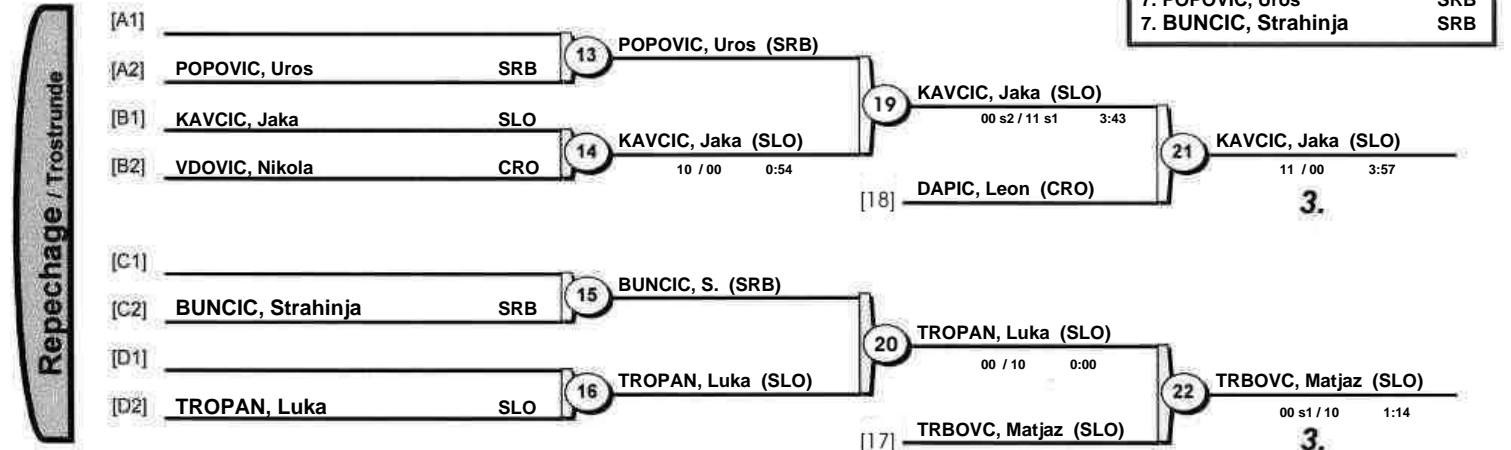

Dubrovnik Senior European Cup 2020

Dubrovnik (CRO), 03-04 Oct 2020

-73 kg

14 Judoka

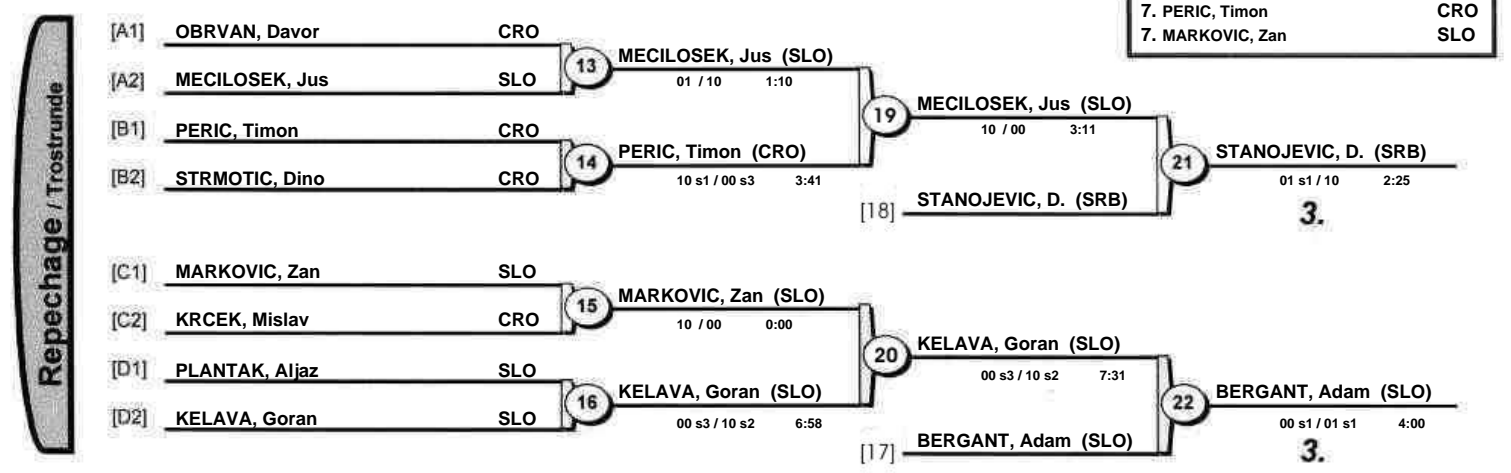
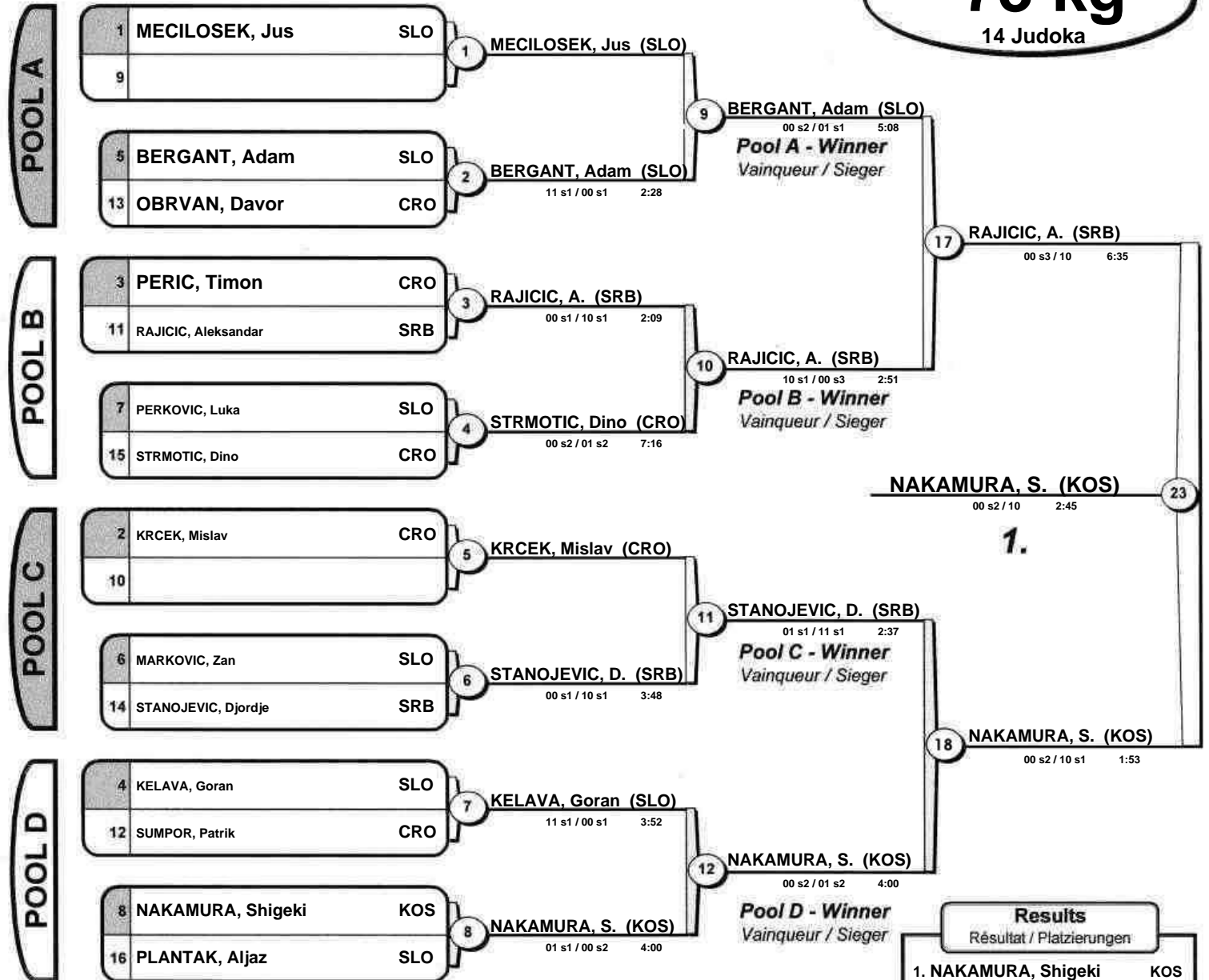

Dubrovnik Senior European Cup 2020

Dubrovnik (CRO), 03-04 Oct 2020

-81 kg

13 Judoka

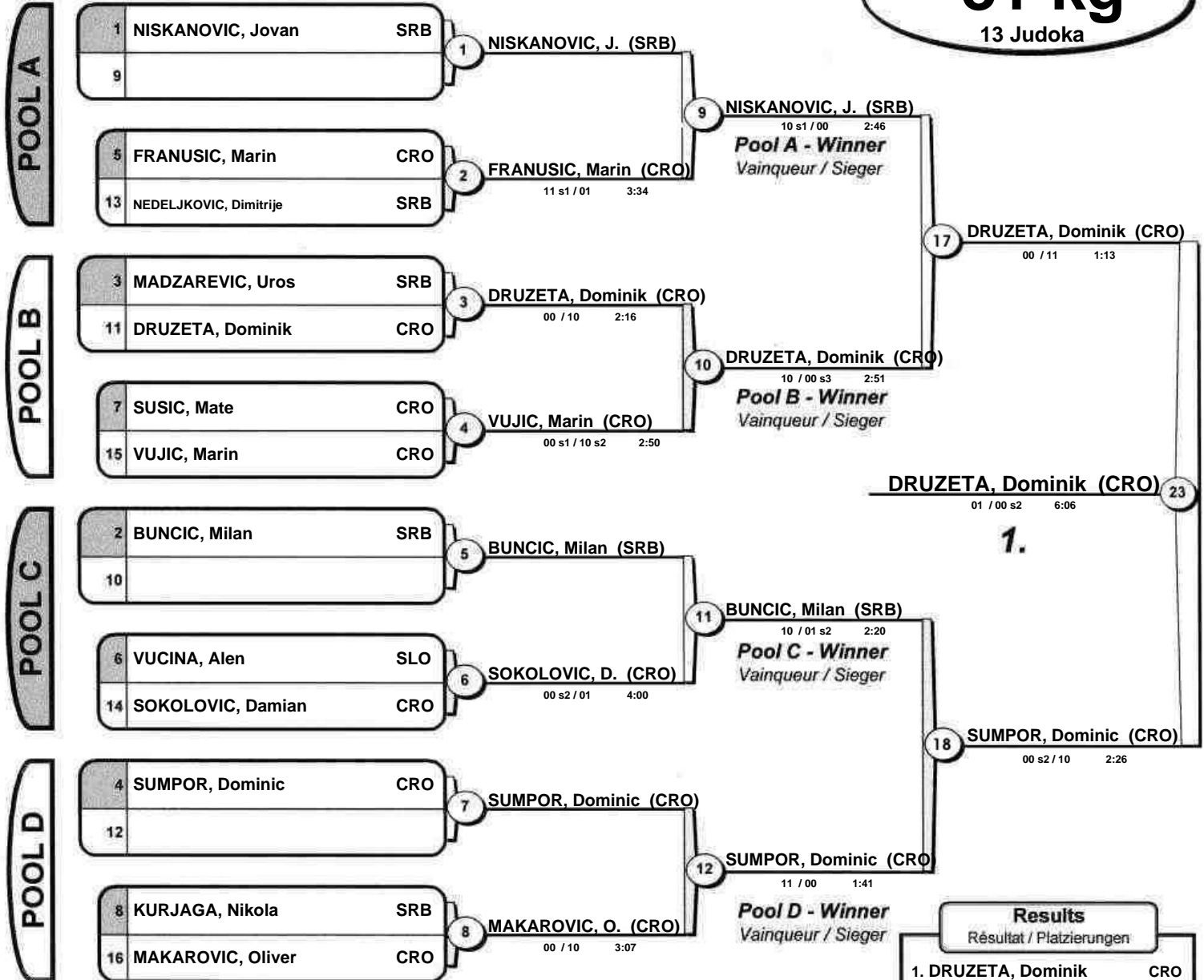

Results	
Résultat / Platzierungen	
1.	DRUZETA, Dominik CRO
2.	SUMPOR, Dominic CRO
3.	BUNCIC, Milan SRB
3.	NISKANOVIC, Jovan SRB
5.	VUJIC, Marin CRO
5.	SOKOLOVIC, Damian CRO
7.	FRANUSIC, Marin CRO
7.	MAKAROVIC, Oliver CRO

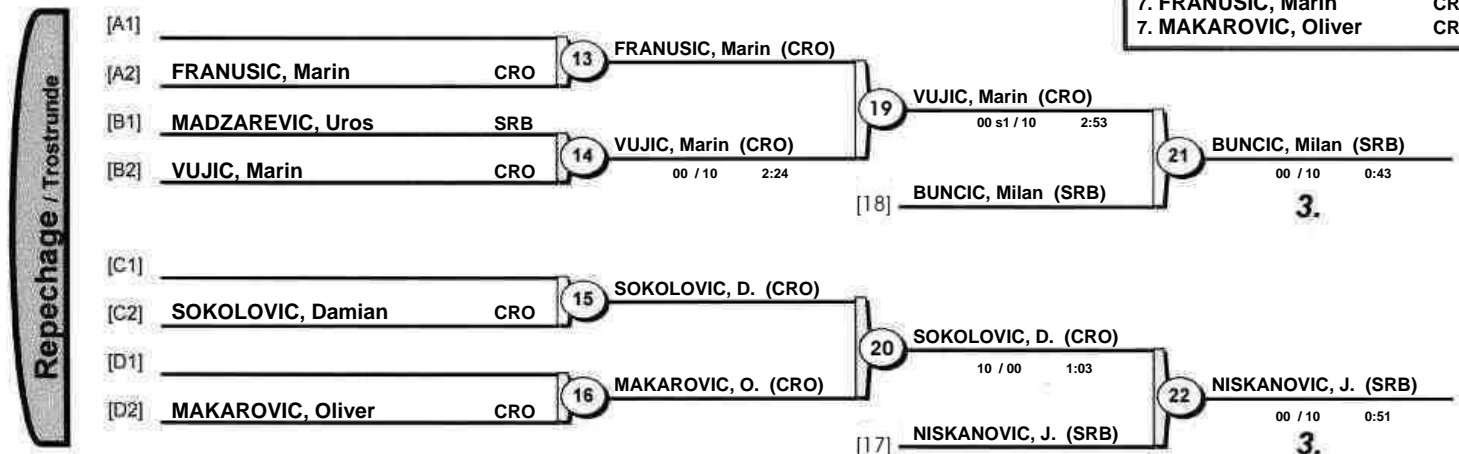

Dubrovnik Senior European Cup 2020

Dubrovnik (CRO), 03-04 Oct 2020

-90 kg

12 Judoka

POOL A

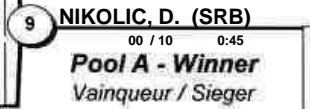
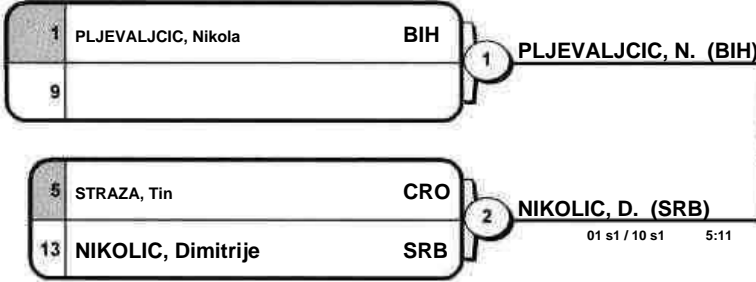

POOL B

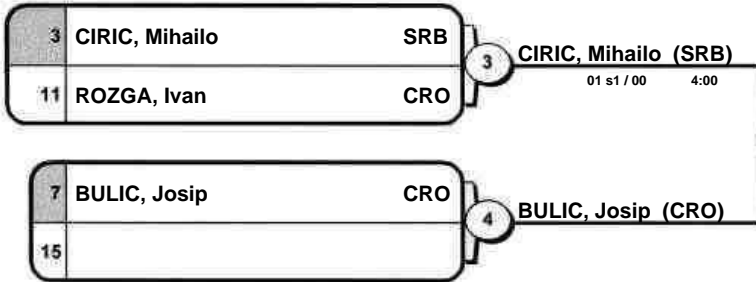

POOL C

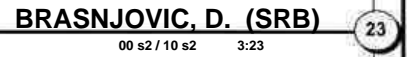
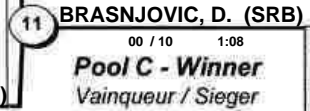
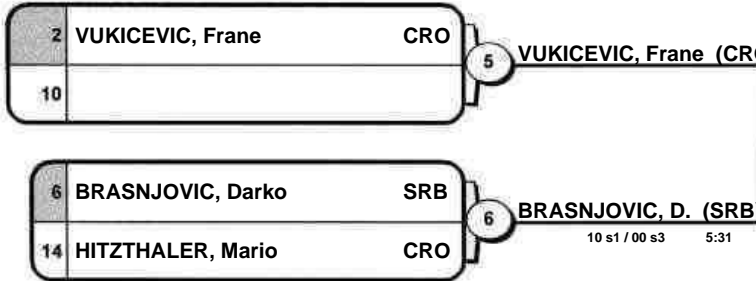

1.

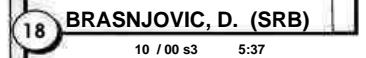

POOL D

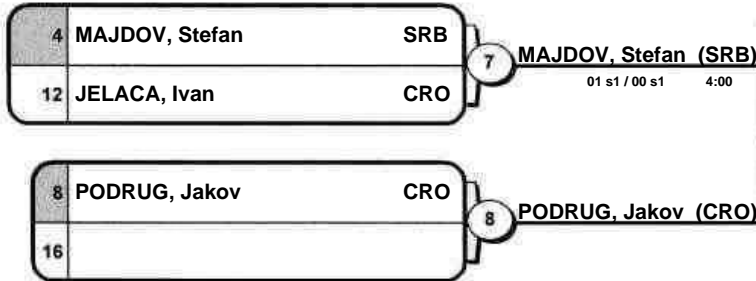

Results		
Résultat / Platzierungen		
1.	BRASNJOVIC, Darko	SRB
2.	BULIC, Josip	CRO
3.	CIRIC, Mihailo	SRB
3.	NIKOLIC, Dimitrije	SRB
5.	PODRUG, Jakov	CRO
5.	VUKICEVIC, Frane	CRO
7.	PLJEVALJCIC, Nikola	BIH
7.	MAJDOV, Stefan	SRB

Repechage / Trostrunde

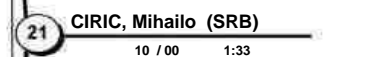
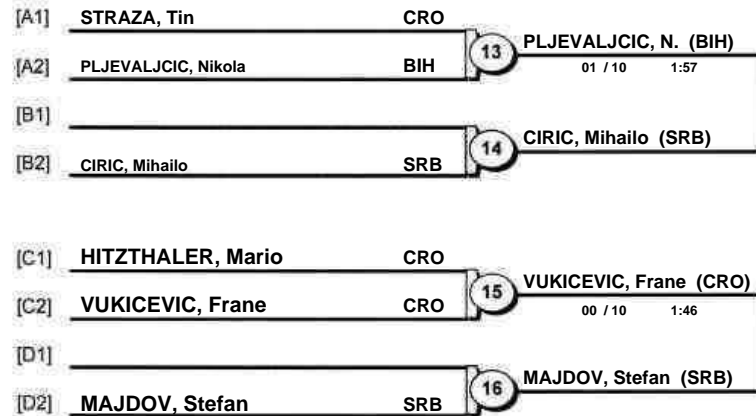

3.

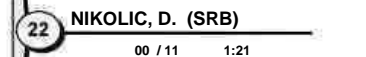

3.

Dubrovnik Senior European Cup 2020

Dubrovnik (CRO), 03-04 Oct 2020

-100 kg

5 Judoka

			1	2	3	4	5		
1	BRATINCEVIC, Domagoj	CRO		0	0	0	0	(0)	
2	KOKEZA, Josip	CRO	1 (10)		0	0	0	1 (10)	
3	KUMRIC, Marko	CRO	1 (10)	1 (10)		1 (10)	0	3 (30)	
4	KUMRIC, Zlatko	CRO	1 (10)	1 (10)	0		0	2 (20)	
5	KUKOLJ, Aleksandar	SRB	1 (10)	1 (10)	1 (10)	1 (1)		4 (31)	

1	BRATINCEVIC, Domagoj	CRO	1	KOKEZA, Josip	CRO
2	KOKEZA, Josip	CRO		01 / 10	1:23

3	KUMRIC, Marko	CRO	2	KUMRIC, Marko	CRO
4	KUMRIC, Zlatko	CRO		10 s1 / 00	0:42

1	BRATINCEVIC, Domagoj	CRO	3	KUKOLJ, Aleksandar	SRB
5	KUKOLJ, Aleksandar	SRB		00 / 11	1:06

2	KOKEZA, Josip	CRO	4	KUMRIC, Marko	CRO
3	KUMRIC, Marko	CRO		00 / 10	0:49

4	KUMRIC, Zlatko	CRO	5	KUKOLJ, Aleksandar	SRB
5	KUKOLJ, Aleksandar	SRB		00 s1 / 01 s1	4:00

1	BRATINCEVIC, Domagoj	CRO	6	KUMRIC, Marko	CRO
3	KUMRIC, Marko	CRO		00 / 10	0:00

2	KOKEZA, Josip	CRO	7	KUMRIC, Zlatko	CRO
4	KUMRIC, Zlatko	CRO		00 s3 / 10	1:11

3	KUMRIC, Marko	CRO	8	KUKOLJ, Aleksandar	SRB
5	KUKOLJ, Aleksandar	SRB		00 / 10 s1	2:12

1	BRATINCEVIC, Domagoj	CRO	9	KUMRIC, Zlatko	CRO
4	KUMRIC, Zlatko	CRO		00 / 10	0:00

2	KOKEZA, Josip	CRO	10	KUKOLJ, Aleksandar	SRB
5	KUKOLJ, Aleksandar	SRB		00 / 10	0:00

Final Results

1. KUKOLJ, Aleksandar SRB
2. KUMRIC, Marko CRO
3. KUMRIC, Zlatko CRO

Dubrovnik Senior European Cup 2020

Dubrovnik (CRO), 03-04 Oct 2020

+100 kg

7 Judoka

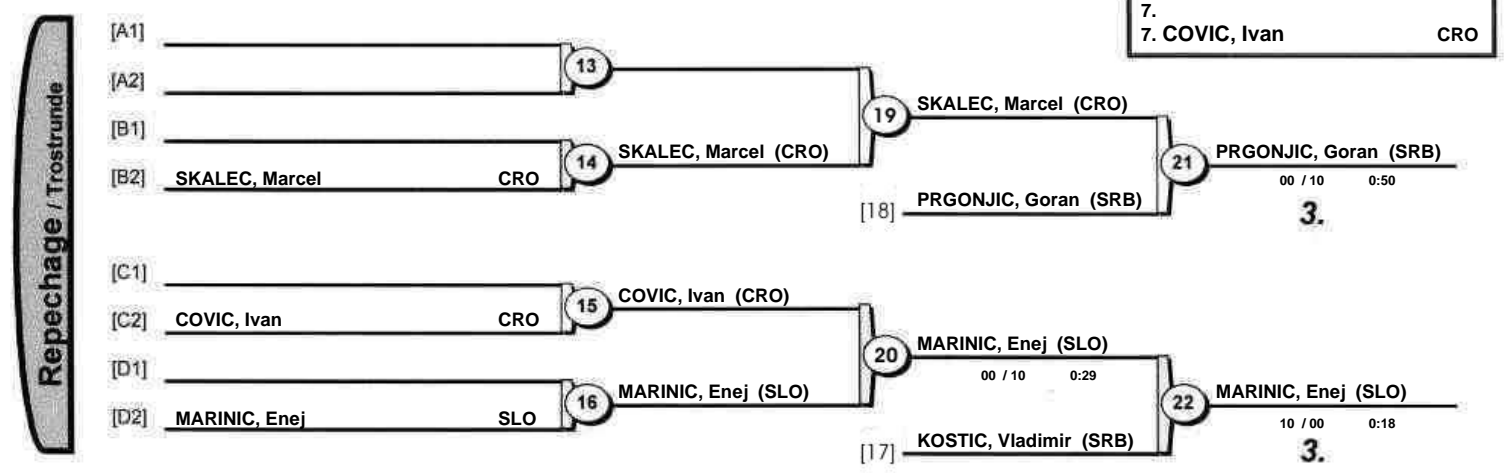
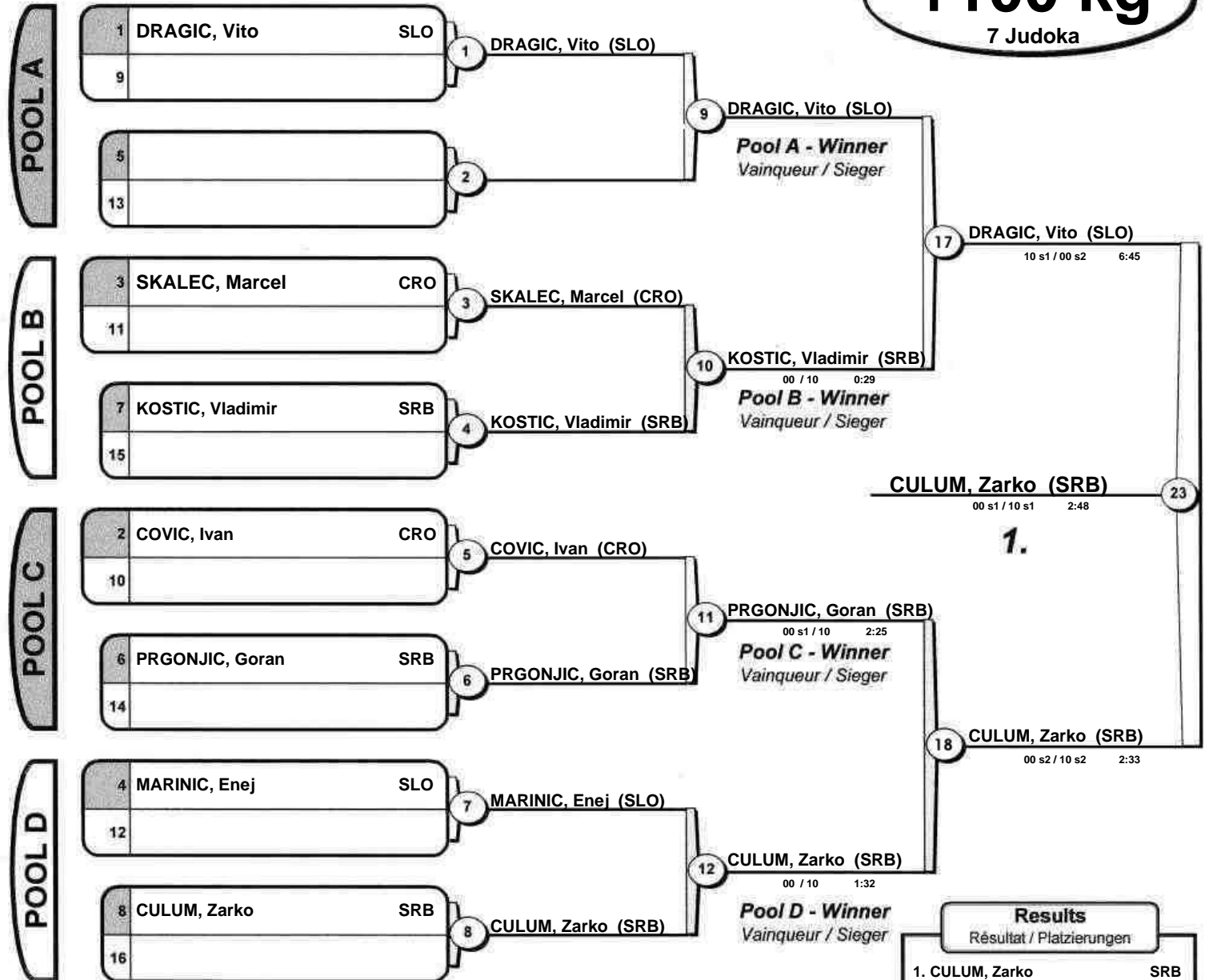

Dubrovnik Senior European Cup 2020

Dubrovnik (CRO), 03-04 Oct 2020

-48 kg

2 Judoka

BEST OF THREE

1	MUMINOVIQ, Erza	KOS	1	STOJADINOV, Andrea	SRB
2	STOJADINOV, Andrea	SRB		00 s2 / 11	3:40

1	MUMINOVIQ, Erza	KOS	2	STOJADINOV, Andrea	SRB
2	STOJADINOV, Andrea	SRB		00 / 10	2:08

1	MUMINOVIQ, Erza	KOS	3	STOJADINOV, Andrea	SRB
2	STOJADINOV, Andrea	SRB		00 / 10	0:00

Final Results

1. STOJADINOV, Andrea SRB
2. MUMINOVIQ, Erza KOS

Dubrovnik Senior European Cup 2020

Dubrovnik (CRO), 03-04 Oct 2020

-52 kg

3 Judoka

			1	2	3	Wins Score	
1	TROPAN, Teja	SLO		0	0	0 0	
2	PULJIZ, Ana Viktorija	CRO	1		0	1 0	
3	PETROVIC, Nadezda	SRB	1	1		2 0	

1	TROPAN, Teja	SLO	1	PULJIZ, Ana Viktorija		CRO
2	PULJIZ, Ana Viktorija	CRO		00 s2 / 01	4:00	

1	TROPAN, Teja	SLO	2	PETROVIC, Nadezda		SRB
3	PETROVIC, Nadezda	SRB		00 / 10	2:53	

2	PULJIZ, Ana Viktorija	CRO	3	PETROVIC, Nadezda		SRB
3	PETROVIC, Nadezda	SRB		00 / 10	1:52	

Final Results

1. PETROVIC, Nadezda SRB
2. PULJIZ, Ana Viktorija CRO
- 3.

Dubrovnik Senior European Cup 2020

Dubrovnik (CRO), 03-04 Oct 2020

-57 kg

6 Judoka

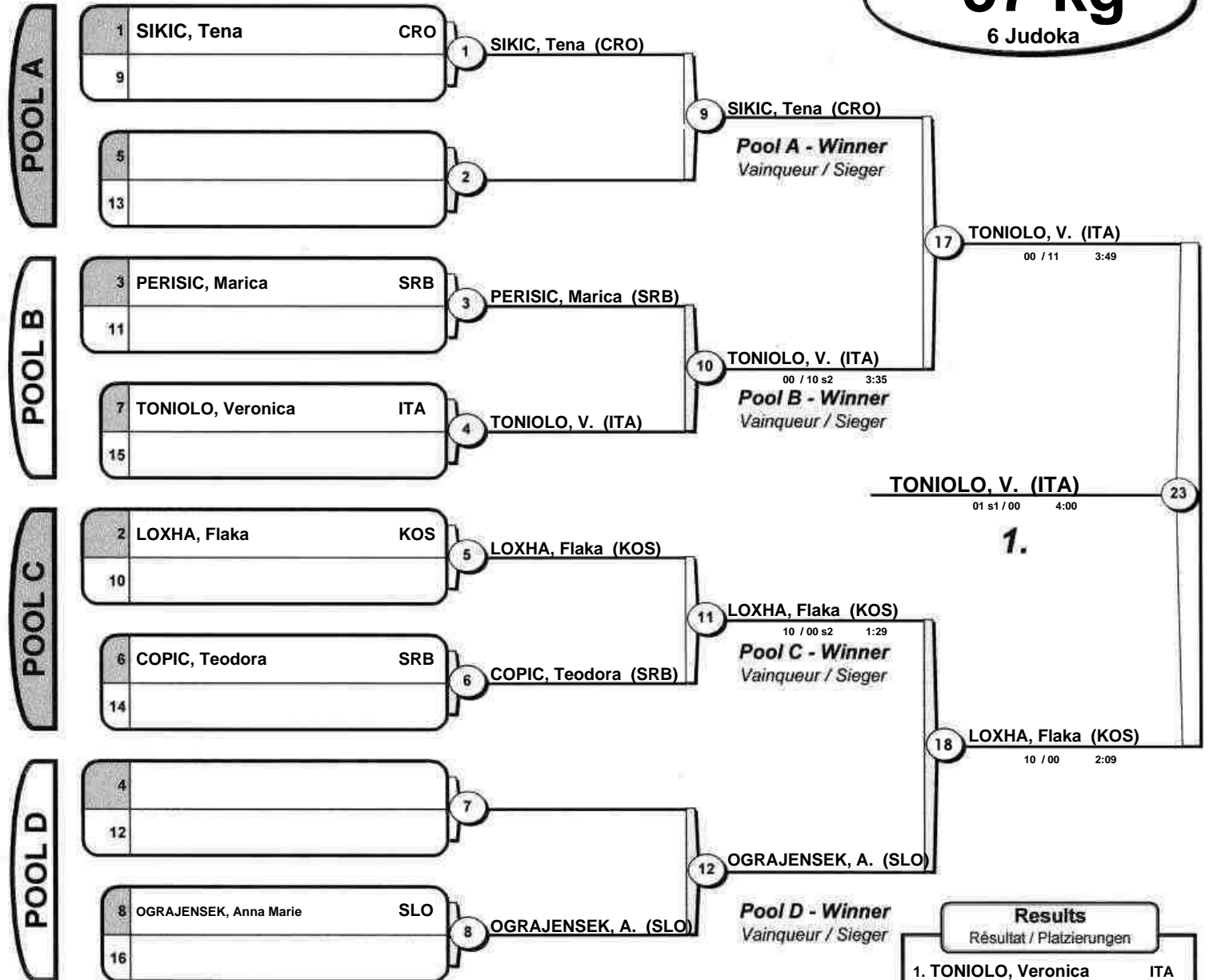

TONIOLO, V. (ITA)	01 s1 / 00	4:00	23
1.			
LOXHA, Flaka (KOS)	10 / 00	2:09	18

Results	
Résultat / Platzierungen	
1. TONIOLO, Veronica	ITA
2. LOXHA, Flaka	KOS
3. PERISIC, Marica	SRB
3. SIKIC, Tena	CRO
5. OGRAJENSEK, Anna Marie	SLO
5. COPIC, Teodora	SRB
7.	
7.	

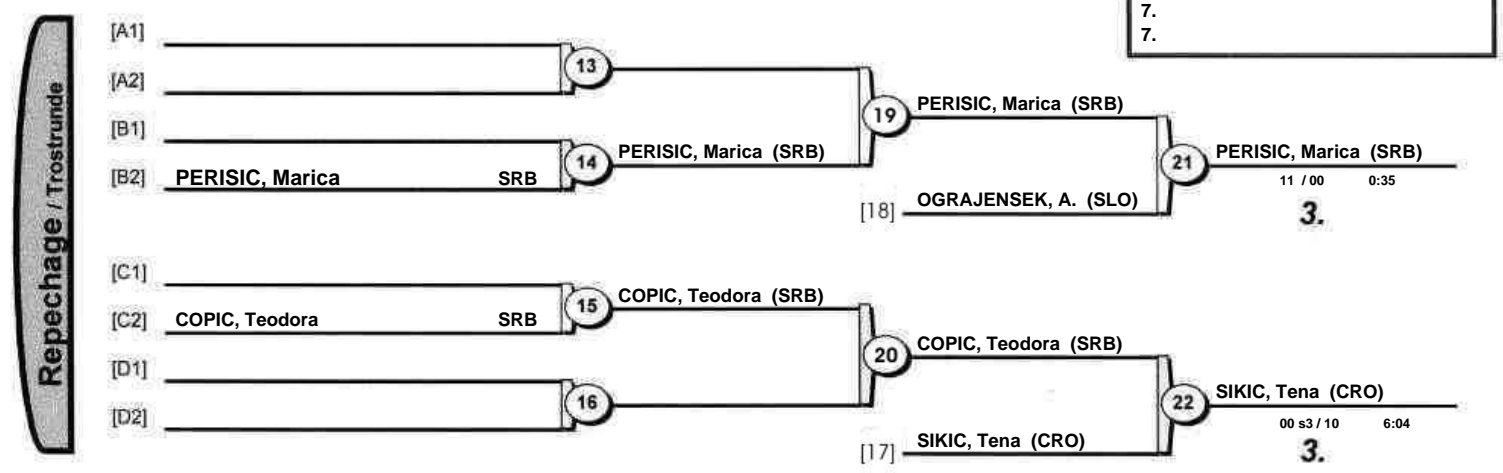

Dubrovnik Senior European Cup 2020

Dubrovnik (CRO), 03-04 Oct 2020

-63 kg

5 Judoka

			1	2	3	4	5		
1	LUDVIK, Lia	SLO		1 (10)	0	1 (10)	1 (1)	3 (21)	
2	OBERAN, Iva	CRO	0		0	1 (10)	1 (10)	2 (20)	
3	FAZLIU, Laura	KOS	1 (10)	1 (10)		1 (10)	0	3 (30)	
4	OBRADOVIC, Anja	SRB	0	0	0		1 (1)	1 (1)	
5	TINTOR, Tea	SRB	0	0	1 (10)	0		1 (10)	

1	LUDVIK, Lia	SLO	①	LUDVIK, Lia	SLO
2	OBERAN, Iva	CRO		10 s2 / 00	2:48

3	FAZLIU, Laura	KOS	②	FAZLIU, Laura	KOS
4	OBRADOVIC, Anja	SRB		10 / 01	0:53

1	LUDVIK, Lia	SLO	③	LUDVIK, Lia	SLO
5	TINTOR, Tea	SRB		01 s2 / 00 s2	5:18

2	OBERAN, Iva	CRO	④	FAZLIU, Laura	KOS
3	FAZLIU, Laura	KOS		00 s1 / 10 s2	5:22

4	OBRADOVIC, Anja	SRB	⑤	OBRADOVIC, Anja	SRB
5	TINTOR, Tea	SRB		01 s1 / 00	4:00

1	LUDVIK, Lia	SLO	⑥	FAZLIU, Laura	KOS
3	FAZLIU, Laura	KOS		00 s2 / 10 s2	9:04

2	OBERAN, Iva	CRO	⑦	OBERAN, Iva	CRO
4	OBRADOVIC, Anja	SRB		11 s1 / 00 s2	3:04

3	FAZLIU, Laura	KOS	⑧	TINTOR, Tea	SRB
5	TINTOR, Tea	SRB		00 s1 / 10	3:55

1	LUDVIK, Lia	SLO	⑨	LUDVIK, Lia	SLO
4	OBRADOVIC, Anja	SRB		10 / 00	0:00

2	OBERAN, Iva	CRO	⑩	OBERAN, Iva	CRO
5	TINTOR, Tea	SRB		10 s1 / 00 s1	4:48

Final Results

- FAZLIU, Laura KOS
- LUDVIK, Lia SLO
- OBERAN, Iva CRO

Dubrovnik Senior European Cup 2020

Dubrovnik (CRO), 03-04 Oct 2020

-70 kg

8 Judoka

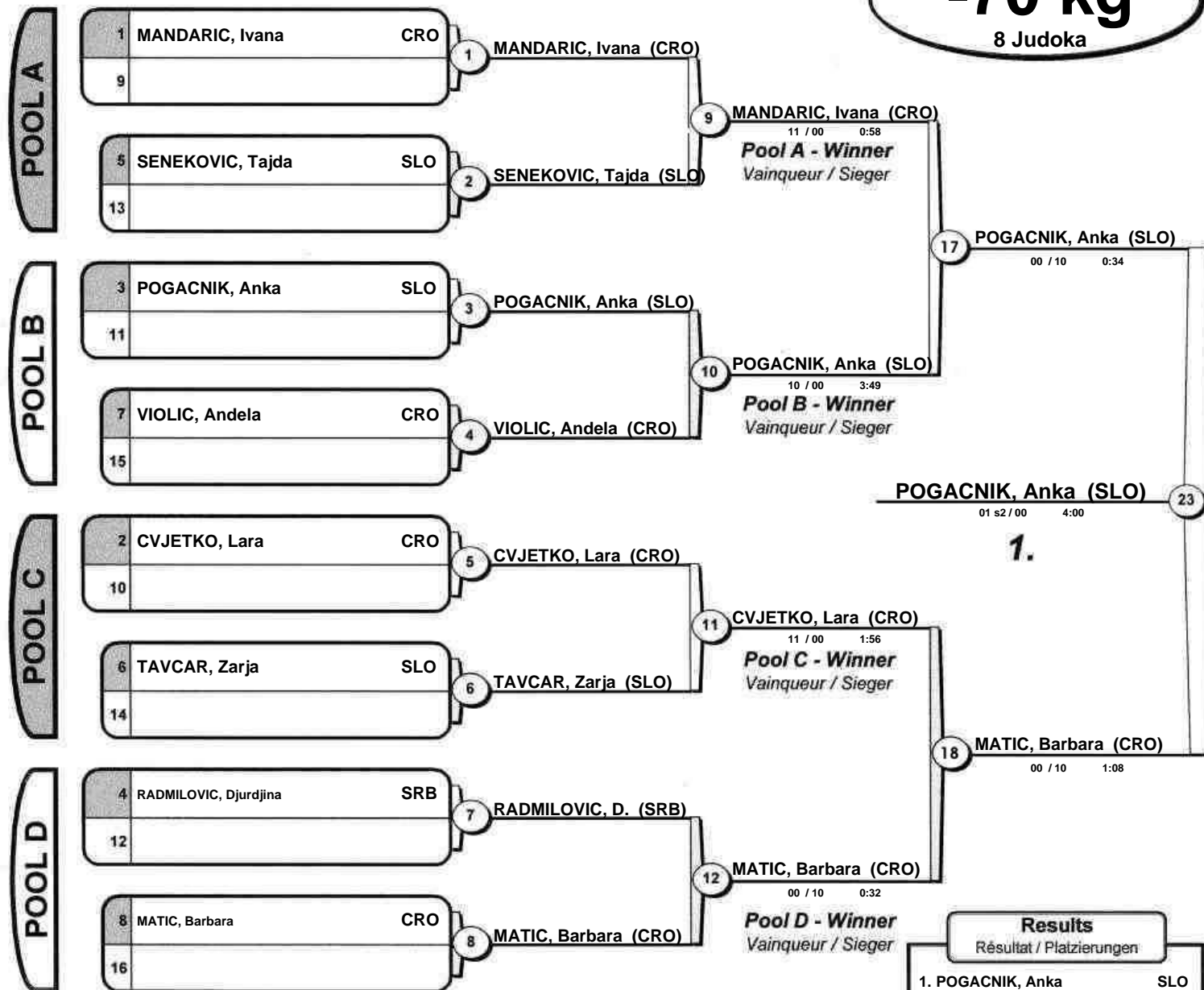

POGACNIK, Anka (SLO) 23
 01 s2 / 00 4:00

Results	
Résultat / Platzierungen	
1.	POGACNIK, Anka SLO
2.	MATIC, Barbara CRO
3.	CVJETKO, Lara CRO
3.	TAVCAR, Zarja SLO
5.	VIOLIC, Andela CRO
5.	MANDARIC, Ivana CRO
7.	SENEKOVIC, Tajda SLO
7.	RADMILOVIC, Djurdjina SRB

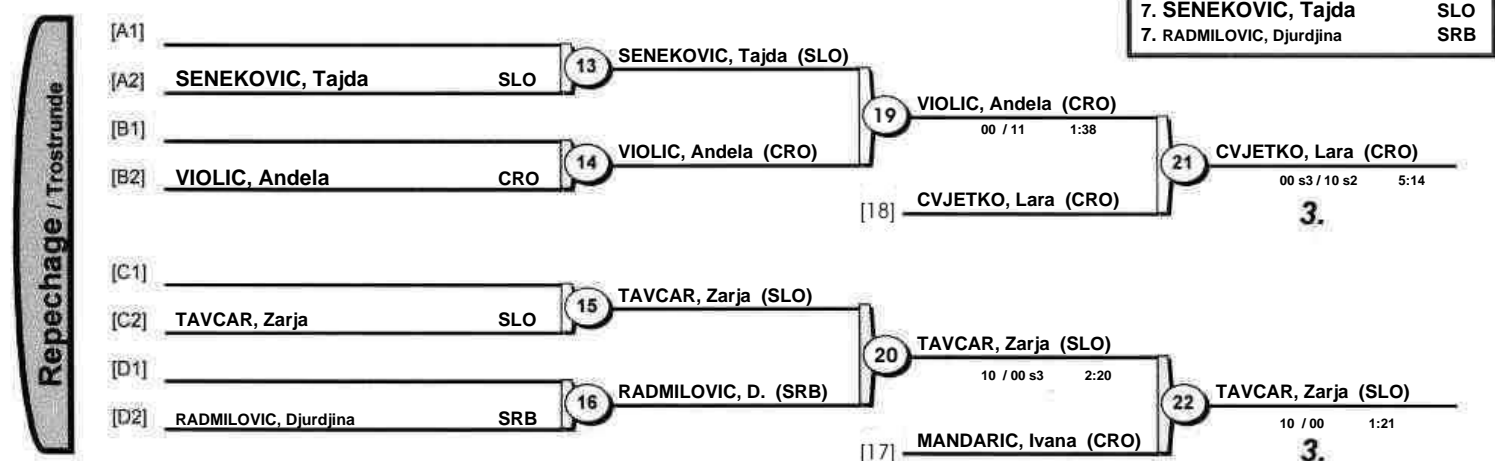

Dubrovnik Senior European Cup 2020

Dubrovnik (CRO), 03-04 Oct 2020

-78 kg

2 Judoka

BEST OF THREE

1	GOBEC, Lea	CRO	1	GOBEC, Lea	CRO	10 s1 / 00 s3	5:40
2	PAVIC, Petrunjela	CRO					

1	GOBEC, Lea	CRO	2	GOBEC, Lea	CRO	10 / 00	0:00
2	PAVIC, Petrunjela	CRO					

1	GOBEC, Lea	CRO	3	GOBEC, Lea	CRO	10 / 00	4:00
2	PAVIC, Petrunjela	CRO					

Final Results

1. GOBEC, Lea CRO
2. PAVIC, Petrunjela CRO

Dubrovnik Senior European Cup 2020

Dubrovnik (CRO), 03-04 Oct 2020

+78 kg

6 Judoka

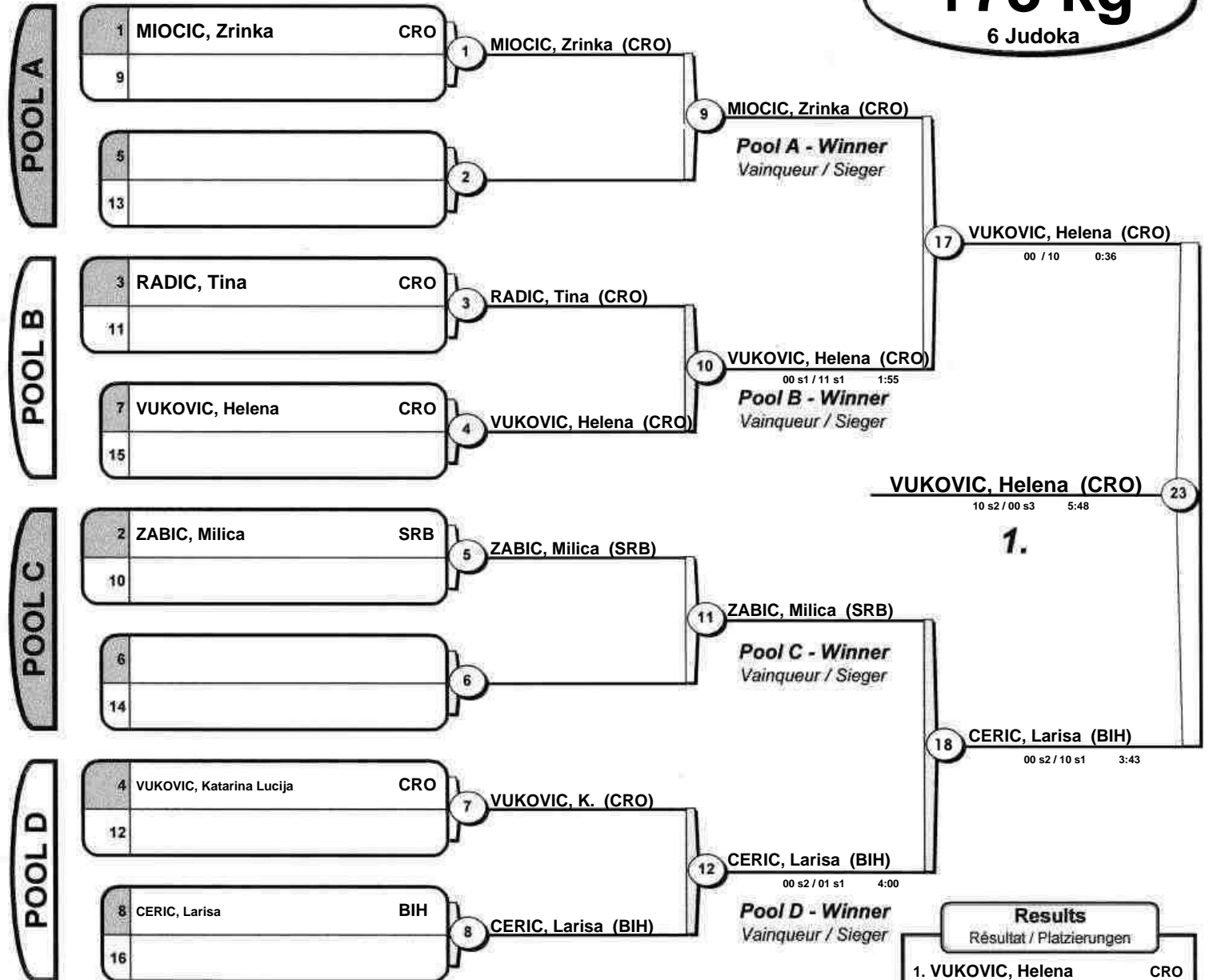

Results	
Résultat / Platzierungen	
1.	VUKOVIC, Helena CRO
2.	CERIC, Larisa BIH
3.	ZABIC, Milica SRB
3.	VUKOVIC, Katarina Lucija CRO
5.	RADIC, Tina CRO
5.	MIOCIC, Zrinka CRO
7.	
7.	

